

# Boxed interface relays and optocouplers R600

## Boxed slim relays, optocouplers and accessories

Boxed interface relays and optocouplers are used for electrical isolation, amplification and signal matching between the electronic controlling, e.g. PLC (programmable logic controller), PC or field bus systems and the sensor / actuator level. The compact design and different connection terminal possibilities optimize your panel installation.

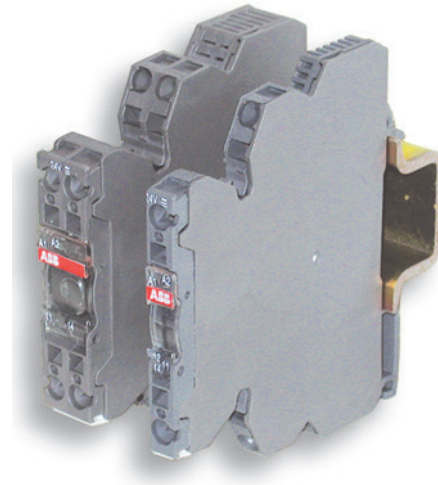





2CDC 295 002 F0013

### Characteristics

- Boxed slim relays and optocoupler modules, 6 mm or 12 mm
- 8 different rated control supply voltages:  
DC versions: 5 V, 12 V, 24 V  
AC/DC versions: 24 V, 48-60 V, 115 V, 230 V, 60-230 V
- Output relay: 1 n/c contact, 1 n/o contact, 1 c/o (SPDT) contact, 2 c/o (SPDT) contacts  
Output optocoupler: Transistor 100 mA - 58 V DC, MOS-FET 2 A / 5 A - 58 V DC, Triac 1 A / 2 A - 230 / 400 V AC
- Devices with output contacts protected by built in RC circuit, which result in increased contact life
- Devices with leakage current protection on the input side
- All products with LED for the indication of the operational state
- Screw or spring-type terminals
- Jumper bars and separator end section as accessories

### Approvals

-  UL 508  
CAN/CSA C22.2 No.14
-  CSA
-  EAC
-  Lloyds Register

### Marks

-  CE

**Ordering details R600 interface relays - 1 n/c contact: 250 V, 10 mA - 6 A, width 12 mm**

Rated control supply voltage	Connection type	Particularities	Type	Order code	Pkg qty	Weight (1 pc) kg (lb)
24 V AC/DC	Screw	RC circuit parallel to output contact	RB101R-24VUC	1SNA645019R0400	5	0.04 (0.088)
	Spring		RBR101R-24VUC	1SNA645519R0600		

**Ordering details R600 interface relays - 1 n/o contact: 250 V, 10 mA - 6 A, width 6 mm**

Rated control supply voltage	Connection type	Particularities	Type	Order code	Pkg qty	Weight (1 pc) kg (lb)
24 V AC/DC	Screw		RB111-24VUC	1SNA645014R2700	10	0.02 (0.044)
115 V AC/DC	Screw		RB111-115VUC	1SNA645016R2100		
230 V AC/DC	Screw		RB111-230VUC	1SNA645017R2200		
24 V AC/DC	Spring		RBR111-24VUC	1SNA645514R2100		

**Ordering details R600 interface relays - 1 n/o contact: 250 V, 10 mA - 6 A, width 12 mm**

Rated control supply voltage	Connection type	Particularities	Type	Order code	Pkg qty	Weight (1 pc) kg (lb)
24 V AC/DC	Screw	RC circuit parallel to output contact	RB111R-24VUC	1SNA645018R0300	5	0.04 (0.088)
	Spring		RBR111R-24VUC	1SNA645518R0500		

**Ordering details R600 interface relays - 1 c/o (SPDT) contact: 250 V, 10 mA - 6 A, width 6 mm**

Rated control supply voltage	Connection type	Particularities	Type	Order code	Pkg qty	Weight (1 pc) kg (lb)
5 V DC	Screw	A1-A2 polarized	RB121P-5VDC	1SNA645034R2300	10	0.02 (0.044)
12 V DC	Screw	A1-A2 polarized	RB121P-12VDC	1SNA645035R2400		
12 V DC	Screw		RB121-12VDC	1SNA645073R0000		
24 V DC	Screw		RB121-24VDC	1SNA645071R0000		
24 V AC/DC	Screw		RB121-24VUC	1SNA645001R0300		
48-60 V AC/DC	Screw		RB121-48-60VUC	1SNA645002R0400		
115 V AC/DC	Screw		RB121-115VUC	1SNA645003R0500		
230 V AC/DC	Screw		RB121-230VUC	1SNA645004R0400		
5 V DC	Spring	A1-A2 polarized	RBR121P-5VDC	1SNA645534R2500		
12 V DC	Spring	A1-A2 polarized	RBR121P-12VDC	1SNA645535R2600		
24 V DC	Spring		RBR121-24VDC	1SNA645571R0000		
24 V AC/DC	Spring		RBR121-24VUC	1SNA645501R0500		
48-60 V AC/DC	Spring		RBR121-48-60VUC	1SNA645502R0600		
115 V AC/DC	Spring		RBR121-115VUC	1SNA645503R0700		
230 V AC/DC	Spring		RBR121-230VUC	1SNA645504R0000		

**Ordering details R600 interface relays - 1 c/o (SPDT) contact: 250 V, 3 mA - 6 A, gold-plated contacts, width 6 mm**

Rated control supply voltage	Connection type	Particularities	Type	Order code	Pkg qty	Weight (1 pc) kg (lb)
5 V DC	Screw	A1-A2 polarized	RB121PG-5VDC	1SNA645036R2500	10	0.02 (0.044)
12 V DC	Screw		RB121G-12VDC	1SNA645075R0000		
24 V DC	Screw		RB121G-24VDC	1SNA645072R0000		
24 V AC/DC	Screw		RB121G-24VUC	1SNA645005R0700		
48-60 V AC/DC	Screw		RB121G-48-60VUC	1SNA645006R0000		
115 V AC/DC	Screw		RB121G-115VUC	1SNA645007R0100		
230 V AC/DC	Screw		RB121G-230VUC	1SNA645008R1200		
24 V DC	Spring		RBR121G-24VDC	1SNA645572R0000		
24 V AC/DC	Spring		RBR121G-24VUC	1SNA645505R0100		
48-60 V AC/DC	Spring		RBR121G-48-60VUC	1SNA645506R0200		
115 V AC/DC	Spring		RBR121G-115VUC	1SNA645507R0300		
230 V AC/DC	Spring		RBR121G-230VUC	1SNA645508R1400		

### Ordering details R600 interface relays - 1 c/o (SPDT) contact: 250 V, 10 mA - 6 A, width 12 mm

Rated control supply voltage	Connection type	Particularities	Type	Order code	Pkg qty	Weight (1 pc) kg (lb)
60-230 V AC/DC	Screw		RB121-60-230VUC	1SNA645020R0100	5	0.04 (0.088)
115 V AC/DC	Screw	Leakage current protection, RC circuit parallel to input	RB121R-115VUC	1SNA645046R0700		
230 V AC/DC	Screw		RB121R-230VUC	1SNA645011R2400		
60-230 V AC/DC	Spring		RBR121-60-230VUC	1SNA645520R0300		
230 V AC/DC	Spring	Leakage current protection, RC circuit parallel to input	RBR121R-230VUC	1SNA645511R2600		

### Ordering details R600 interface relays - 2 c/o (SPDT) contacts: 250 V, 1 mA - 8 A, gold-plated contacts, width 12 mm

Rated control supply voltage	Connection type	Type	Order code	Pkg qty	Weight (1 pc) kg (lb)
24 V AC/DC	Screw	RB122G-24VUC	1SNA645012R2500	5	0.04 (0.088)
48-60 V AC/DC	Screw	RB122G-48-60VUC	1SNA645040R1500		
115 V AC/DC	Screw	RB122G-115VUC	1SNA645041R0200		
230 V AC/DC	Screw	RB122G-230VUC	1SNA645013R2600		
24 V AC/DC	Spring	RBR122G-24VUC	1SNA645512R2700		
48-60 V AC/DC	Spring	RBR122G-48-60VUC	1SNA645540R1700		
115 V AC/DC	Spring	RBR122G-115VUC	1SNA645541R0400		
230 V AC/DC	Spring	RBR122G-230VUC	1SNA645513R2000		

### Ordering details R600 optocouplers - Transistor output, 58 V DC, 100 mA, width 6 mm

Rated control supply voltage	Connection type	Type	Order code	Pkg qty	Weight (1 pc) kg (lb)
5 - 12 V DC	Screw	OBIC0100-5-12VDC	1SNA645047R0000	10	0.02 (0.044)
24 V DC	Screw	OBIC0100-24VDC	1SNA645021R2600		
48 - 60 V AC/DC	Screw	OBIC0100-48-60VUC	1SNA645049R1200		
115 - 230 V AC/DC	Screw	OBIC0100-115-230	1SNA645022R2700		
5 - 12 V DC	Spring	OBRIC0100-5-12VDC	1SNA645547R0200	10	0.02 (0.044)
24 V DC	Spring	OBRIC0100-24VDC	1SNA645521R2000		
48 - 60 V AC/DC	Spring	OBRIC0100-48-60VUC	1SNA645549R1400		
115 - 230 V AC/DC	Spring	OBRIC0100-115-230	1SNA645522R2100		

### Ordering details R600 optocouplers - MOS-FET output, 58 V DC, 2 A, width 6 mm

Rated control supply voltage	Connection type	Type	Order code	Pkg qty	Weight (1 pc) kg (lb)
5 - 12 V DC	Screw	OBOC2000-5-12VDC	1SNA645050R1700	10	0.02 (0.044)
24 V DC	Screw	OBOC2000-24VDC	1SNA645051R0400		
24 V AC/DC	Screw	OBOC2000-24VUC	1SNA645025R2200		
48 - 60 V AC/DC	Screw	OBOC2000-48-60VUC	1SNA645053R0600		
115 V AC/DC	Screw	OBOC2000-115VUC	1SNA645054R0700		
230 V AC/DC	Screw	OBOC2000-230VUC	1SNA645026R2300		
5 - 12 V DC	Spring	OBROC2000-5-12VDC	1SNA645550R1100	10	0.02 (0.044)
24 V DC	Spring	OBROC2000-24VDC	1SNA645551R0600		
24 V AC/DC	Spring	OBROC2000-24VUC	1SNA645525R2400		
48 - 60 V AC/DC	Spring	OBROC2000-48-60VUC	1SNA645553R0000		
230 V AC/DC	Spring	OBROC2000-230VUC	1SNA645526R2500		

### Ordering details R600 optocouplers - MOS-FET output, 58 V DC, 5 A, width 6 mm

Rated control supply voltage	Connection type	Type	Order code	Pkg qty	Weight (1 pc) kg (lb)
24 V DC	Screw	OBOC5000-24VDC	1SNA645024R2100	10	0.02 (0.044)
115 V AC/DC	Screw	OBOC5000-115VUC	1SNA645058R1300		
24 V DC	Spring	OBROC5000-24VDC	1SNA645524R2300	10	0.02 (0.044)
230 V AC/DC	Spring	OBROC5000-230VUC	1SNA645559R1600		

### Ordering details R600 optocouplers - Triac output, 400 V AC, 1 A, width 6 mm

Rated control supply voltage	Connection type	Type	Order code	Pkg qty	Weight (1 pc) kg (lb)
24 V DC	Screw	OBOA1000-24VDC	1SNA645027R2400	10	0.03 (0.066)
115 V AC/DC	Screw	OBOA1000-115VUC	1SNA645062R0700		
230 V AC/DC	Screw	OBOA1000-230VUC	1SNA645028R0500		
24 V DC	Spring	OBROA1000-24VDC	1SNA645527R2600	10	0.03 (0.066)

### Ordering details R600 optocouplers - Triac output, 230 V AC, 2 A, width 12 mm

Rated control supply voltage	Connection type	Type	Order code	Pkg qty	Weight (1 pc) kg (lb)
24 V DC	Screw	OBOA2000-24VDC	1SNA645029R0600	5	0.03 (0.066)
24 V DC	Spring	OBROA2000-24VDC	1SNA645529R0000	5	0.03 (0.066)

### Ordering details - Accessories

Description	Type	Order code	Pkg qty	Weight (1 pc) kg (lb)
Jumper bar, 10 poles	BJ612-10	1SNA290488R0100	10	0.05 (0.11)
Jumper bar, 20 poles	BJ612-20	1SNA206754R0000		0.01 (0.022)
Separator end section	SC612	1SNA290474R0200		0.05 (0.11)
Front marking blank cards, 100 pcs.	RC610	1SNA233000R0100		
Terminal marking blank cards, 100 pcs.	RC65	1SNA232000R0000		

## Electrical connection

11-12 n/c contact  
 13-14 n/o contact  
 11-12/14 1st c/o contact  
 21-22/24 2nd c/o contact

A1-A2 Control supply voltage  
 S1 Connection for jumper bar (input side)  
 S2 Connection for jumper bar (output side)

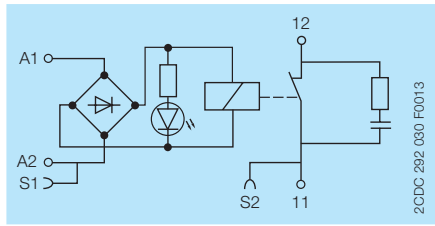

**RB(R)101R - 24VUC**

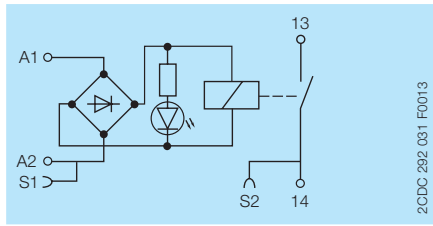

**RB(R)111-24VUC**

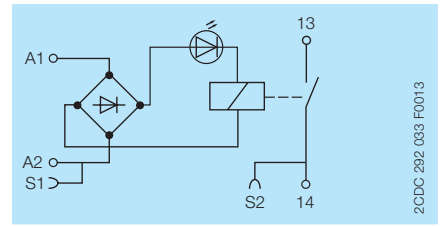

**RB111-115VUC/230VUC**

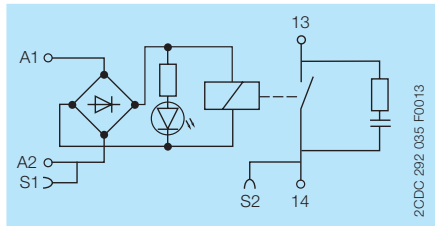

**RB(R)111R-24VUC**

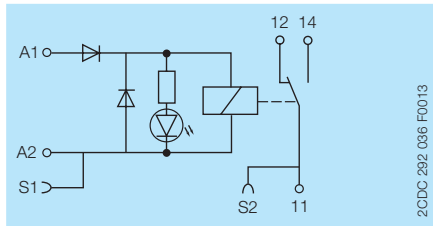

**RB(R)121P(G)-5VDC/12VDC**

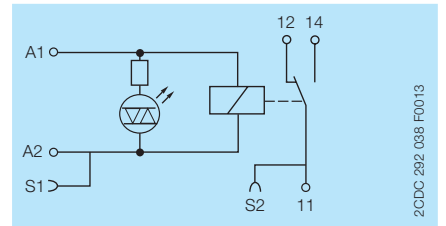

**RB(R)121-12VDC/24VDC**

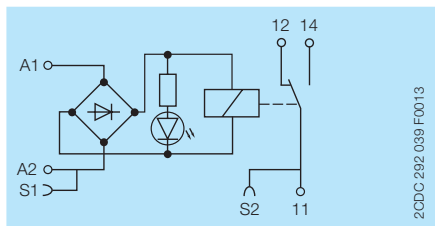

**RB(R)121(G)-24VUC**

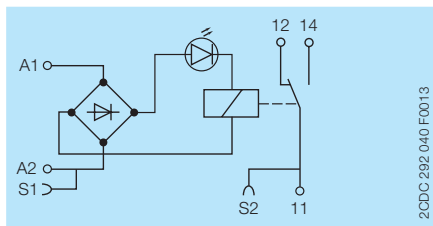

**RB(R)121(G)-48-60VUC/  
115VUC/230VUC/60-230VUC**

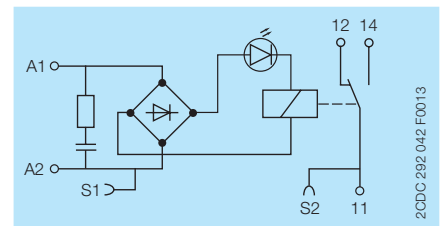

**RB(R)121R-115VUC/230VUC**

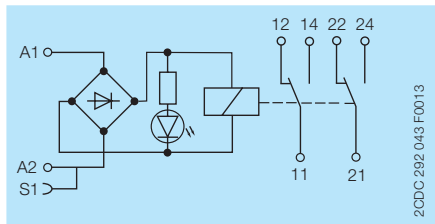

**RB(R)122G-24VUC/48-60VUC**

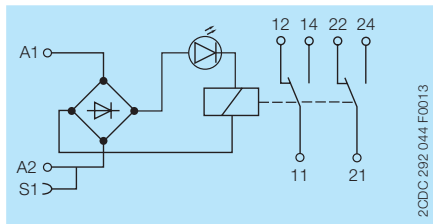

**RB(R)122G-115VUC/230VUC**

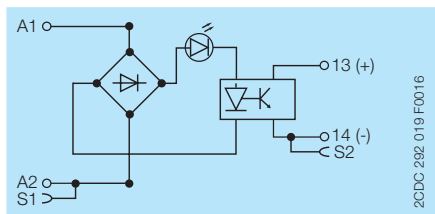

**OB(R)OC, OB(R)IC  
except 5-12VDC versions**

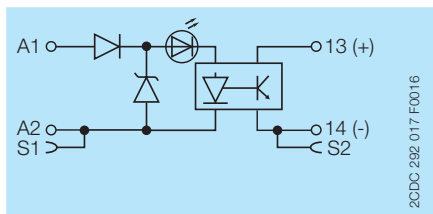

**OB(R)IC0100-5-12VDC  
OB(R)OC2000-5-12VDC**

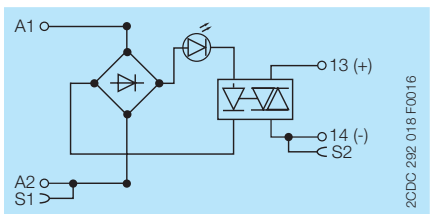



**OB(R)OA**

## Technical data - Interface relays

		RB(R)101R-		RB(R)111R-	
		24VUC		24VUC	
<b>Input circuit</b>					
Rated control supply voltage $U_s$		24 V AC/DC			
Rated control supply voltage $U_s$ tolerance	DC	-15 %, +20 %			
	AC	-/+ 10 %			
Rated frequency		50/60 Hz			
Typical power consumption		0.24 W			
Typical current		10 mA			
Drop-out voltage	at 20 °C	4.5 V			
Indication of operational states	green LED	J: control supply voltage applied			
<b>Output circuit</b>					
Kind of output	11-12	relay, 1 n/c contact		-	
	13-14	-		relay, 1 n/o contact	
Rated operational voltage $U_e$		250 V AC			
Minimum switching voltage		12 V			
Maximum switching voltage		250 V AC			
Minimum switching current		10 mA			
Rated free air thermal current $I_{th}$		6 A			
Rated operational current $I_e$	AC-12 (resistive) 230 V	6 A			
	AC-15 (inductive) 230 V	1.5 A			
	AC-15 (inductive) 120 V	3 A			
	DC-12 (resistive) 24 V	6 A			
	DC-13 (inductive) 24 V	1 A			
	DC-13 (inductive) 110 V	0.2 A			
	DC-13 (inductive) 220 V	0.1 A			
AC rating (UL 508; NEMA ICS-5)	Utilization category (pilot duty)	B300			
DC rating (UL 508; NEMA ICS-5)	Utilization category (pilot duty)	R300			
Minimum switching power		0.6 W / 0.6 VA			
Mechanical lifetime		1 x 10 <sup>7</sup> switching cycles			
Electrical lifetime	at AC-15	1 x 10 <sup>5</sup> switching cycles			
Max. fuse rating to achieve short-circuit protection		6 A fast			
Response time		5 ms			
Release time		8 ms			

		RB(R)111-		
		24VUC	115VUC	230VUC
<b>Input circuit</b>				
Rated control supply voltage $U_s$		24 V AC/DC	115 V AC/DC	230 V AC/DC
Rated control supply voltage $U_s$ tolerance	DC	-15 %, +20 %		
	AC	-/+ 10 %		
Rated frequency		50/60 Hz		
Typical power consumption		0.24 W	0.46 W	0.8 W
Typical current		10 mA	4 mA	3.5 mA
Drop-out voltage	at 20 °C	4.5 V	17 V	27 V
Indication of operational states	green LED	J: control supply voltage applied		
<b>Output circuit</b>				
Kind of output	13-14	relay, 1 n/o contact		
Rated operational voltage $U_e$		250 V AC		
Minimum switching voltage		12 V		
Maximum switching voltage		250 V AC		
Minimum switching current		10 mA		
Rated free air thermal current $I_{th}$		6 A		
Rated operational current $I_e$	AC-12 (resistive) 230 V	6 A		
	AC-15 (inductive) 230 V	1.5 A		
	AC-15 (inductive) 120 V	3 A		
	DC-12 (resistive) 24 V	6 A		
	DC-13 (inductive) 24 V	1 A		
	DC-13 (inductive) 110 V	0.2 A		
	DC-13 (inductive) 220 V	0.1 A		
AC rating (UL 508; NEMA ICS-5)	Utilization category (pilot duty)	B300		
DC rating (UL 508; NEMA ICS-5)	Utilization category (pilot duty)	R300		
Minimum switching power		0.6 W / 0.6 VA		
Mechanical lifetime		1 x 10 <sup>7</sup> switching cycles		
Electrical lifetime	at AC-15	1 x 10 <sup>5</sup> switching cycles		
Max. fuse rating to achieve short-circuit protection		6 A fast		
Response time		5 ms	6 ms	7 ms
Release time		8 ms	15 ms	15 ms

		RB(R)121(P)(G)-							
		5VDC	12VDC	24VDC	24VUC	48-60VUC	115VUC	230VUC	
<b>Input circuit</b>									
Rated control supply voltage U <sub>s</sub>		5 V DC	12 V DC	24 V DC	24 V AC/DC	48 V AC/DC	60 V AC/DC	115 V AC/DC	230 V AC/DC
Rated control supply voltage U <sub>s</sub>	DC	-15 %, +20 %							
tolerance	AC	-				-/+ 10 %		-15 %, +10 %	
Rated frequency		-				50/60 Hz			
Typical power consumption		0.2 W	0.2 W	0.24 W		0.33 W	0.54 W	0.46 W	0.8 W
Typical current		40 mA	16 mA	10 mA		7 mA	9 mA	4 mA	3.5 mA
Drop-out voltage	at 20 °C	1.2 V	2.2 V	4.5 V		8 V	8 V	17 V	27 V
Indication of operational states	green LED	 : control supply voltage applied							
<b>Output circuit</b>									
Kind of output	11-12/14	relay, 1 c/o (SPDT) contact							
Rated operational voltage U <sub>e</sub>		250 V AC							
Minimum switching voltage		12 V / gold-plated contacts: 5 V							
Maximum switching voltage		250 V AC							
Minimum switching current		10 mA / gold-plated contacts: 3 mA at 20 V							
Rated free air thermal current I <sub>th</sub>		6 A							
Rated operational current I <sub>e</sub>	AC-12 (resistive) 230 V	6 A							
	AC-15 (inductive) 230 V	1.5 A							
	AC-15 (inductive) 120 V	3 A							
	DC-12 (resistive) 24 V	6 A							
	DC-13 (inductive) 24 V	1 A							
	DC-13 (inductive) 110 V	0.2 A							
	DC-13 (inductive) 220 V	0.1 A							
AC rating (UL 508; NEMA ICS-5)	Utilization category (pilot duty)	B300							
DC rating (UL 508; NEMA ICS-5)	Utilization category (pilot duty)	R300							
Minimum switching power		0.6 W / 0.6 VA; gold plated contacts: 0.06 V / 0.06 VA							
Mechanical lifetime		1 x 10 <sup>7</sup> switching cycles							
Electrical lifetime	at AC-15	1 x 10 <sup>5</sup> switching cycles							
Max. fuse rating to achieve short-circuit protection		6 A fast							
Response time		5 ms	5 ms	5 ms		5 ms	5 ms	6 ms	7 ms
Release time		8 ms	8 ms	8 ms		8 ms	8 ms	15 ms	16 ms

		RB(R)121R-			
		115VUC			230VUC
<b>Input circuit</b>					
Rated control supply voltage U <sub>s</sub>		115 V AC/DC			230 V AC/DC
Rated control supply voltage U <sub>s</sub>	DC	-20%, +15%			-10%, +15%
tolerance	AC	-/+ 10 %			
Rated frequency		50/60 Hz			
Typical power consumption		2 W			2.8 W
Typical current		18 mA			12 mA
Drop-out voltage	at 20 °C	17 V			27 V
Indication of operational states	green LED	 : control supply voltage applied			
<b>Output circuit</b>					
Kind of output	11-12/14	relay, 1 c/o (SPDT) contact			
Rated operational voltage U <sub>e</sub>		250 V AC			
Minimum switching voltage		12 V			
Maximum switching voltage		250 V AC			
Minimum switching current		10 mA			
Rated free air thermal current I <sub>th</sub>		6 A			
Rated operational current I <sub>e</sub>	AC-12 (resistive) 230 V	6 A			
	AC-15 (inductive) 230 V	1.5 A			
	AC-15 (inductive) 120 V	3 A			
	DC-12 (resistive) 24 V	6 A			
	DC-13 (inductive) 24 V	1 A			
	DC-13 (inductive) 110 V	0.2 A			
	DC-13 (inductive) 220 V	0.1 A			
AC rating (UL 508; NEMA ICS-5)	Utilization category (pilot duty)	B300			
DC rating (UL 508; NEMA ICS-5)	Utilization category (pilot duty)	R300			
Minimum switching power		0.6 W / 0.6 VA			
Mechanical lifetime		1 x 10 <sup>7</sup> switching cycles			
Electrical lifetime	at AC-15	1 x 10 <sup>5</sup> switching cycles			
Max. fuse rating to achieve short-circuit protection		6 A fast			
Response time		6 ms			7 ms
Release time		15 ms			16 ms



		RB(R)122G				
		24VUC	48-60VUC	60 V AC/DC	115VUC	230VUC
<b>Input circuit</b>						
Rated control supply voltage $U_s$		24 V AC/DC	48 V AC/DC	60 V AC/DC	115 V AC/DC	230 V AC/DC
Rated control supply voltage $U_s$ tolerance	DC AC	-15 %, +20 % -/+ 10 %				-15 %, +10 %
Rated frequency		50/60 Hz				
Typical power consumption		0.48 W	0.62 W	0.96 W	0.58 W	1.15 W
Typical current		20 mA	13 mA	16 mA	5 mA	5 mA
Drop-out	at 20 °C	5.4 V	8.8 V	8.8 V V	20 V	10 V
Indication of operational states	green LED	J: control supply voltage applied				
<b>Output circuit</b>						
Kind of output	11-12/14 21-22/24	relay, 1st c/o (SPDT) contact relay, 2nd c/o (SPDT) contact				
Rated operational voltage $U_e$		250 V AC				
Minimum switching voltage		5 V				
Maximum switching voltage		250 V DC - 250 V AC				
Minimum switching current		1 mA				
Rated free air thermal current $I_{th}$		8 A				
Rated operational current $I_e$	AC-12 (resistive) 230 V AC-15 (inductive) 230 V DC-12 (resistive) 24 V DC-13 (inductive) 24 V DC-13 (inductive) 110 V DC-13 (inductive) 220 V	8 A 1.5 A 8 A 1 A 0.2 A 0.1 A				
Minimum switching power		5 mW / 5 mVA				
Mechanical lifetime		2 x 10 <sup>7</sup> switching cycles				
Electrical lifetime	at AC-15	1 x 10 <sup>5</sup> switching cycles				
Max. fuse rating to achieve short-circuit protection		10 A fast				
Response time		6 ms	10 ms	10 ms	6 ms	6 ms
Release time		10 ms	14 ms	14 ms	15 ms	15 ms

## General technical data - Interface relays

		RB	RBR
<b>General data</b>			
Material of housing		UL 94 V0	
Mounting		DIN Rail	
Degree of protection	housing / terminals	IP20 NEMA1	
<b>Electrical connection</b>			
		Screw terminal	Spring-type terminal
Connecting capacity	fine-strand rigid	0.22-2.5 mm <sup>2</sup> (24-14 AWG) 0.2-4 mm <sup>2</sup> (24-12 AWG)	0.2-2.5 mm <sup>2</sup> (24-14 AWG)
Stripping length		9 mm (0.354 in)	
Tightening torque		0.4-0.6 Nm (3.5-5.3 lb.in)	n/a
<b>Environmental data</b>			
Ambient temperature ranges	storage operation	-40...+80 °C (-40...+176 °F) -20...+70 °C (-4...+158 °F)	
<b>Isolation data</b>			
Rated insulation voltage $U_i$		250 V	
Rated impulse withstand voltage $U_{imp}$	input / output shock coil / output output / output	4 kV 4 kV 1 kV	
Overvoltage category		III	
Pollution degree		2	
<b>Standards / Directives</b>			
Standards		IEC/EN 60947-5-1	
EMC Directive		2014/30/EU	
Low Voltage Directive		2014/35/EU	
RoHS Directive		2011/65/EU	



## Technical data - Optocouplers

	OB(R)IC0100-...						
	5-12VDC		24VDC	48-60VUC		115-230	
<b>Input circuit</b>							
Input voltage	5 V DC	12 V DC	24 V DC	48 V AC/DC	60 V AC/DC	115 V AC/DC	230 V AC/DC
Frequency	-			50/60 Hz			
Input current	5 mA	9 mA	4 mA	4 mA	5 mA	7 mA (AC) 16 mA (DC)	11.5 mA (AC) 25 mA (DC)
Pull-in voltage	4 V		15 V	25 V		60 V AC / 70 V DC	
Typ. switch-on time	10 µs			5 ms			
Typ. switch-off time	500 µs			20 ms			
Operating frequency	1000 Hz			20 Hz			
Permissible leakage current	0.9 mA		1.0 mA	0.9 mA		1.6 mA	
<b>Output circuit</b>							
<b>11(13+)- 14</b>							
Kind of output	Transistor						
Rated operational voltage	4.5-58 V DC						
Minimum switching current	1 mA						
Maximum switching current	100 mA						
Leakage current at max. switching voltage	< 50 µA						
Rated operational current I <sub>o</sub>	DC-12 (resistive) 58 V 0.1 A						
Residual voltage	typical 1 V maximum 1.3 V						
Max. fuse rating to achieve short-circuit protection	100 mA fast						
<b>Isolation data</b>							
Rated insulation voltage U <sub>i</sub>	250 V						
Rated impulse withstand voltage U <sub>imp</sub>	2.5 kV						
Overvoltage category	II						
Pollution degree	2						

	OB(R)OC2000-...							
	5-12VDC		24VDC	24VUC	48-60VUC		115VUC	230VUC
<b>Input circuit</b>								
Input voltage	5 V DC	12 V DC	24 V DC	24 V AC/DC	48 V AC/DC	60 V AC/DC	115 V AC/DC	230 V AC/DC
Frequency	-			50/60 Hz				
Input current	5 mA	9 mA	5.4 mA	6.3 mA	4 mA	5.1 mA	4.2 mA	4 mA
Pull-in voltage	4 V	12 V	15 V	15 V	27 V	50 V	80 V	80 V
Typ. switch-on time	15 µs	30 µs	1 ms	5 ms	5 ms	500 µs	1 ms	1 ms
Typ. switch-off time	250 µs	400 µs	7 ms	20 ms	20 ms	10 ms	15 ms	15 ms
Operating frequency	2000 Hz	1000 Hz	60 Hz	20 Hz	20 Hz	50 Hz	35 Hz	35 Hz
Permissible leakage current	1 mA	0.8 mA	0.9 mA	1 mA	1 mA	0.3 mA	0.3 mA	0.3 mA
<b>Output circuit</b>								
<b>11(13+)- 14</b>								
Kind of output	MOS-FET							
Rated operational voltage	4.5-58 V DC							
Minimum switching current	1 mA							
Maximum switching current	2 A							
Leakage current at max. switching voltage	< 50 µA							
Rated operational current I <sub>o</sub>	DC-12 (resistive) 58 V 2 A							
Residual voltage	typical 0.1 V maximum 0.5 V							
Max. fuse rating to achieve short-circuit protection	2 A ultra-fast							
<b>Isolation data</b>								
Rated insulation voltage U <sub>i</sub>	250 V							
Rated impulse withstand voltage U <sub>imp</sub>	2.5 kV							
Overvoltage category	II							
Pollution degree	2							

	OB(R)OC5000-...		
	24VDC	115VUC	230VUC
<b>Input circuit</b>			
Input voltage	24 V DC	115 V AC/DC	230 V AC/DC
Frequency	-	50/60 Hz	
Input current	5.4 mA	4.2 mA	4 mA
Pull-in voltage	12 V	50 V	80 V
Typ. switch-on time	30 µs	500 µs	1 ms
Typ. switch-off time	400 µs	10 ms	15 ms
Operating frequency	1000 Hz	50 Hz	35 Hz
Permissible leakage current	0.8 mA	0.3 mA	
<b>Output circuit</b> <b>11(13+)- 14</b>			
Kind of output	MOS-FET		
Rated operational voltage	4.5-58 V DC		
Minimum switching current	1 mA		
Maximum switching current	5 A		
Leakage current at max. switching voltage	< 50 µA		
Rated operational current I <sub>o</sub>	5 A		
Residual voltage	typical	0.1 V	
	maximum	0.5 V	
Max. fuse rating to achieve short-circuit protection	6 A ultra-fast		
<b>Isolation data</b>			
Rated insulation voltage U <sub>i</sub>	250 V		
Rated impulse withstand voltage U <sub>imp</sub>	2.5 kV		
Overvoltage category	II		
Pollution degree	2		

	OB(R)OA1000-...			OB(R)OA2000-...
	24VDC	115VUC	230VUC	24VDC
<b>Input circuit</b>				
Input voltage	24 V DC	115 V AC/DC	230 V AC/DC	24 V DC
Frequency	-	50/60 Hz		-
Input current	3.6 mA	4.15 mA	4.6 mA	3.6 mA
Pull-in voltage	14 V	60 V	135 V	14 V
Typ. switch-on time	150 µs	2.2 ms	2.5 ms	150 µs
Typ. switch-off time	1 ms	18 ms	25 ms	1 ms
Operating frequency	500 Hz	25 Hz	20 Hz	500 Hz
Permissible leakage current	1 mA			1 mA
<b>Output circuit</b> <b>11(13+)- 14</b>				
Kind of output	Triac			Triac
Rated operational voltage	24-400 V AC			10-230 V AC
Minimum switching current	25 mA			25 mA
Maximum switching current	1 A			2 A
Leakage current at max. switching voltage	< 500 µA			< 500 µA
Rated operational current I <sub>o</sub>	1 A			-
Residual voltage	typical	1 V		2A
	maximum	1.6 V		1 V
Max. fuse rating to achieve short-circuit protection	4 A ultra-fast			4 A ultra-fast
<b>Isolation data</b>				
Rated insulation voltage U <sub>i</sub>	400 V			230 V
Rated impulse withstand voltage U <sub>imp</sub>	4 kV			4 kV
Overvoltage category	II			II
Pollution degree	2			2

## General technical data - Optocouplers

	OB	OBR
<b>General data</b>		
Material of housing	UL 94 V0	
Mounting	DIN Rail	
Degree of protection	housing / terminals IP20 NEMA1	
<b>Electrical connection</b>		
	<b>Screw terminal</b>	<b>Spring-type terminal</b>
Connecting capacity	fine-strand with/without wire end ferrule 0.22-2.5 mm <sup>2</sup> (24-14 AWG)	
	rigid	0.2-2.5 mm <sup>2</sup> (24-14 AWG)
Stripping length	9 mm (0.354 in)	
Tightening torque	0.4-0.6 Nm (3.5-5.3 lb.in)	n/a
<b>Environmental data</b>		
Ambient temperature ranges	storage	-40...+80 °C (-40...+176 °F)
	operation	-20...+70 °C (-4...+158 °F)
<b>Standards / Directives</b>		
Standards	IEC/EN 60947-5-1	
EMC Directive	2014/30/EU	
Low Voltage Directive	2014/35/EU	
RoHS Directive	2011/65/EU	

## Technical diagrams

### Load limit curves

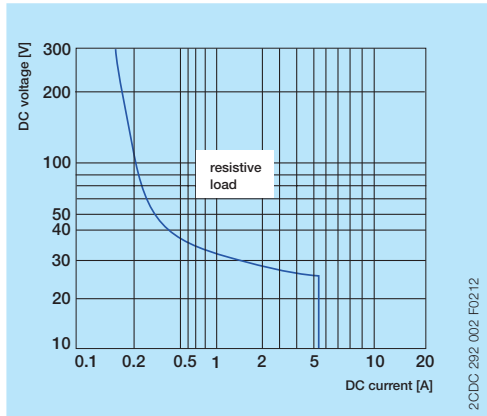

Versions with 1 n/o, 1 n/c or 1 c/o contact

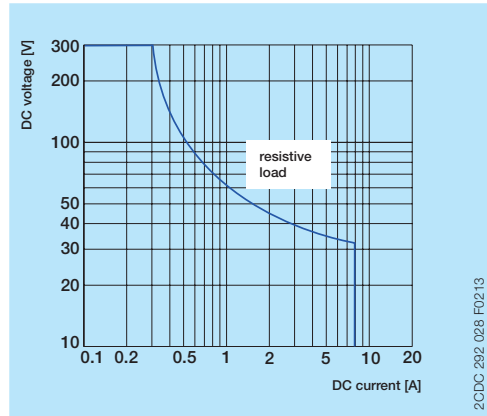

Versions with 2 c/o contacts

## Dimensions

in mm and inches

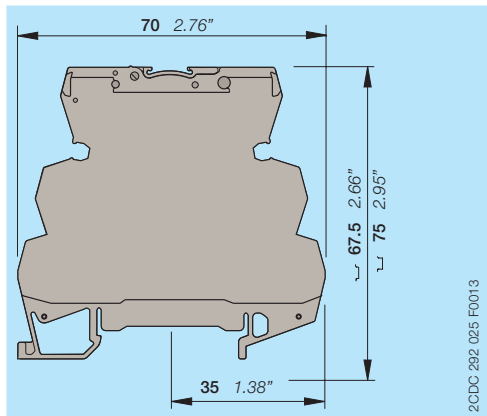

Versions with screw terminals

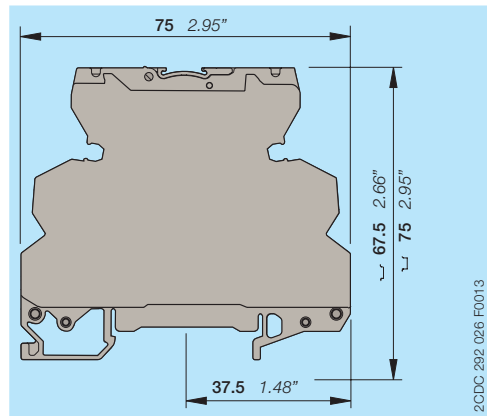

Versions with spring-type terminals

## Further documentation

Document title	Document type	Document number
Electronic Products and Relays	Technical catalogue	2CDC 110 004 C02xx

You can find the documentation on the internet at [www.abb.com/lowvoltage](http://www.abb.com/lowvoltage)

-> Automation, control and protection -> Electronic relays and controls

-> Interface relays and optocouplers.

## CAD system files

You can find the CAD files for CAD systems at <http://abb-control-products.partcommunity.com>

-> Low Voltage Products & Systems -> Control Products -> Electronic Relays and Controls.

# Contact us

## **ABB STOTZ-KONTAKT GmbH**

P. O. Box 10 16 80  
69006 Heidelberg, Germany  
Phone: +49 (0) 6221 7 01-0  
Fax: +49 (0) 6221 7 01-13 25  
E-mail: info.desto@de.abb.com

You can find the address of your  
local sales organization on the  
ABB home page  
<http://www.abb.com/contacts>  
-> Low Voltage Products and Systems

### **Note:**

We reserve the right to make technical changes or modify the contents of this document without prior notice. With regard to purchase orders, the agreed particulars shall prevail. ABB AG does not accept any responsibility whatsoever for potential errors or possible lack of information in this document.

We reserve all rights in this document and in the subject matter and illustrations contained therein. Any reproduction, disclosure to third parties or utilization of its contents – in whole or in parts – is forbidden without prior written consent of ABB AG.

Copyright© 2016 ABB  
All rights reserved