

Electromagnetic process lock

Magne

Magne is an electromagnetic process lock intended for locking doors and hatches.

Magne is usually used to prevent unwanted process interruptions, e.g. during a welding operation.

Magne models with integrated Adam safety sensor make it easy to achieve the highest safety level for the interlocking function.



Reliable in extreme conditions

Sealed aluminium housing

IP67 sealing makes Magne suitable for harsh environments.

Robust design

The electromagnetic lock without mechanical moving parts is a robust design with fewer parts that are subject to wear.

Hygienic design

Flat surfaces without cavities or screws sticking out minimize the risk of accumulating dirt on the surface.



Easy to install

M12 connectors

Quick and easy cabling with M12 connectors.

Magnets simplify installation

Electromagnets offer larger mounting tolerances than mechanical locks.



Continuous operation

LED diagnostics

Integrated LED diagnostics reduce down time when troubleshooting.

Strong holding force

A holding force of up to 1500 N prevents unwanted process stops.

Applications and features

Magne

Applications

Protect the process

Magne 4 is a process lock, with a safe interlocking function. This means that the interlocking function reaches PL e/SIL3 but the unlocking signal is not a safe signal. A typical application is to prevent unintentional/unnecessary interruptions of a sensitive process when the dangerous movement has a very short stop time.

Magne 3 is a simple lock without any interlocking function/safety function.

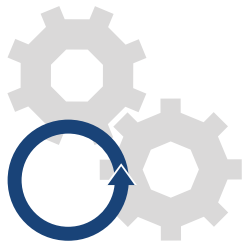

Harsh environments

With a hygienic enclosure in anodized aluminum and IP67 protection class, Magne is well suited for harsh environments.



Features

PL e in a simple and cost effective way

Magne 4 has an integrated Adam sensor. Models are available with either Adam DYN or Adam OSSD. Eva General code or Eva Unique code is ordered separately. The use of the Eden safety sensor makes it easy to reach PL e/SIL3 for the interlocking function, and enables serial connection of several Magne 4 locks to the Pluto safety PLC using only one input for Eden DYN and two for Eden OSSD. Tina 12A can be used for the serial connection of two Magne 4 locks in order to simplify connection, reduce cabling and risk of connection errors.



Optional permanent magnet

Anchor plates for Magne are ordered separately and are available with or without permanent magnet. A permanent magnet holds the door closed when Magne is unlocked, or if there is a power loss. Without the permanent magnet, Magne has no magnetic field when unlocked, which avoids the accumulation of metallic particles on the magnet.

M12 connectors

Since the Adam sensor is integrated in Magne 4, the amount of cables is reduced so that only one cable is necessary for both the locking of Magne and the interlocking with Eden. The M12 connectors speed up connection and reduce the risk of connection errors.



Status indication

Most models offer an info signal indicating whether the Magne is locked or not, which simplifies troubleshooting and improves user friendliness.

Locking and interlocking

An interlocking function indicates if a door is open or closed and prevents movement when the door is open. But it does not prevent the door from being opened. A locking function makes sure the door is kept closed.

Ordering information

Magne



Magne 3

2TLC010070V0201



Magne 4

2TLC010072V0201



Anchorplate

2TLC010085V0201



JSM D28

2TLC172167F0201

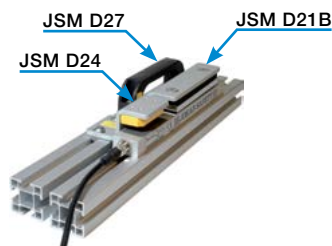

JSM D27
JSM D24
JSM D21B



JSM D23



Tina 12A

2TLC172483F0201

Ordering details

For a complete Magne lock both door part and frame part is necessary. Magne 4 also requires a separate Eva sensor.

Safe interlocking with integrated Adam	Safety signal	Extra function	Connector	Type	Order code
No	-	-	M12-5 male	Magne 3X M12-5	2TLA042022R2700
Yes	DYNlink	-	M12-5 male	Magne 4X DYN M12-5	2TLA042022R3000
		"Locked" and "Closed" information outputs	M12-8 male	Magne 4 DYN-Info	2TLA042022R3400
	OSSD	"Locked" and "Closed" information outputs	M12-8 male	Magne 4 OSSD-Info	2TLA042022R4600

Accessories

Description	Type	Order code
Aluminium profile for door handle that completely covers a Magne unit when the door is closed. For conventional door (5–15 mm door gap)	JSM D28	2TLA042023R0100
Mounting kit for Magne. For conventional door (5 - 15 mm door gap) *	JSM D21B	2TLA042023R0500
Mounting kit for Magne. For sliding door *	JSM D23	2TLA042023R0200
Mounting kit for Eva. For conventional door*	JSM D24	2TLA042023R0300
Door handle for JSM D21B	JSM D27	2TLA042023R1000
Y-connector for serial connection of Magne 3	M12-3A	2TLA020055R0000
Connection block for serial connection of two Magne, Dalton or Knox (M12-8)	Tina 12A	2TLA020054R1800
Cellular rubber, 10 mm thick. Spare part for anchor plate.	Cellular rubber	2TLA042023R3600

* All mounting kits include the bolts and nuts necessary to mount Magne on ABB Quick-Guard® fencing system

Door part

Description	Type	Order code
Anchor plate with permanent magnet. Delivered with cellular rubber.	Magne Anchor 32B	2TLA042023R0400
Anchor plate without permanent magnet. Delivered with cellular rubber.	Magne Anchor 32A	2TLA042023R1300

Eva sensor for Magne 4 models

Compatible Adam	Code description	Code level	Type	Order code
Adam DYN and OSSD	General code. (Eva is interchangeable)	Low level	Eva General code	2TLA020046R0800
	Unique code. (Prevents defeat/fraud)	High level	Eva Unique code	2TLA020046R0900

Ordering information

Magne



M12-C61

2TLC17295FR0201



M12-C61HE

2TLC010003FR0201



M12-C334

2TLC17293FR0201

Cable with connectors

Connector	Female/male	Length	Special feature	Type	Order code	
M12-5	Female	6 m		M12-C61	2TLA020056R0000	
			Harsh environment, halogen free	M12-C61HE	2TLA020056R8000	
		10 m		M12-C101	2TLA020056R1000	
	Female + male	20 m		Harsh environment, halogen free	M12-C101HE	2TLA020056R8100
				M12-C201	2TLA020056R1400	
		0.3 m		M12-C0312	2TLA020056R5800	
		0.06 m		M12-C00612	2TLA020056R6300	
		1 m		M12-C112	2TLA020056R2000	
		3 m		M12-C312	2TLA020056R2100	
		6 m		M12-C612	2TLA020056R2200	
		10 m		M12-C1012	2TLA020056R2300	
			Angled female connector	M12-C1012V2	2TLA020056R6700	
		16 m		M12-C1612	2TLA020056R5400	
20 m		M12-C2012	2TLA020056R2400			
M12-8	Female	6 m		M12-C63	2TLA020056R3000	
		10 m		M12-C103	2TLA020056R4000	
		20 m		M12-C203	2TLA020056R4100	
	Female + male	0.06 m		M12-C00634	2TLA020056R6400	
		1 m		M12-C134	2TLA020056R5000	
		3 m		M12-C334	2TLA020056R5100	

Separate cables and connectors

Description	Type	Order code
Connectors		
M12-5 pole female, straight	M12-C01	2TLA020055R1000
M12-5 pole male, straight	M12-C02	2TLA020055R1100
M12-8 pole female, straight	M12-C03	2TLA020055R1600
M12-8 pole male, straight	M12-C04	2TLA020055R1700



M12-C01

2TLC17285FR0201



C5 cable

2TLC010038FR0201

Cable with 5 conductors

10 m cable with 5 x 0.34 shielded conductors	C5 cable 10 m	2TLA020057R0001
50 m cable with 5 x 0.34 shielded conductors	C5 cable 50 m	2TLA020057R0005
100 m cable with 5 x 0.34 shielded conductors	C5 cable 100 m	2TLA020057R0010
200 m cable with 5 x 0.34 shielded conductors	C5 cable 200 m	2TLA020057R0020
500 m cable with 5 x 0.34 shielded conductors	C5 cable 500 m	2TLA020057R0050



Cable with 8 conductors

50 m cable with 8 x 0.34 shielded conductors	C8 cable 50 m	2TLA020057R1005
100 m cable with 8 x 0.34 shielded conductors	C8 cable 100 m	2TLA020057R1010
200 m cable with 8 x 0.34 shielded conductors	C8 cable 200 m	2TLA020057R1020
500 m cable with 8 x 0.34 shielded conductors	C8 cable 500 m	2TLA020057R1050

Technical data

Magne

Technical data

	Magne 3	Magne 4
Approvals		
Conformity	CE 2014/35/EU - Low voltage 2011/65/EU - RoHS	CE 2006/42/EC - Machinery 2014/30/EU - EMC 2011/65/EU - RoHS EN ISO 12100:2010, EN ISO 13849-1:2015, EN 62061:2005/A2:2015, EN 60204-1:2006+A1:2009, EN 60664-1:2007, EN 61000-6-2:2005, EN 61000-6-4:2007+A1:2011, EN 60947-5-3:2013, EN ISO 14119:2013
Functional safety data	EN 61508:2010 EN 62061:2005 EN ISO 13849-1:2008	Interlocking function: SIL3, $PFH_b = 4.50 \times 10^{-9}$ Interlocking function: SILCL3, $PFH_b = 4.50 \times 10^{-9}$ Interlocking function: PL e, Cat. 4, $PFH_b = 4.50 \times 10^{-9}$
Electrical data		
Operating voltage	+24 VDC \pm 15%	
Holding force		
+24 VDC	Min 1500 N	
0 V, Anchor plate 32A	0 N	
0 V, Anchor plate 32B	30 N	
Mechanical data		
Mechanical life	$>10^7$ switch operations	
Operating temperature	-20...+50°C	
Humidity range	35 to 85% (with no icing or condensation)	
Protection class	IP67	
Weight		
	610 g	700 g
Anchor plate 32A/B	290 g	
Material		
Anchor plate	Iron with nickel coating	
Electromagnet	Iron with zinc-nickel coating	
Housing	Anodized aluminum with parts in polycarbonate	
Potting	PUR, epoxy	

More information

For more information, e.g. the complete technical information, see product manual for:

[Magne 2TLC172315M0201](#)

Dimension drawings

Magne

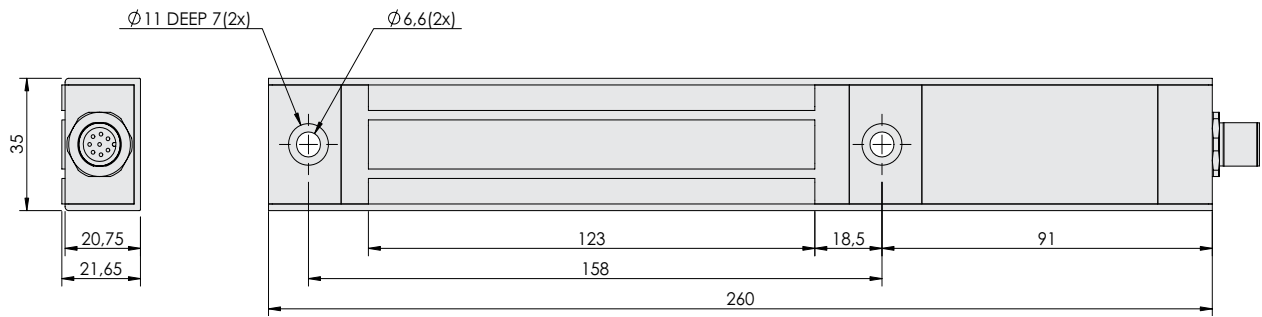

Anchor plate 32A

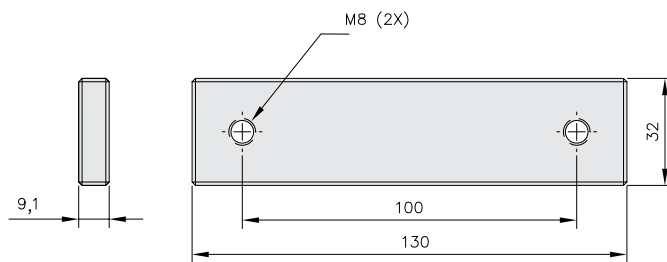

Anchor plate 32B

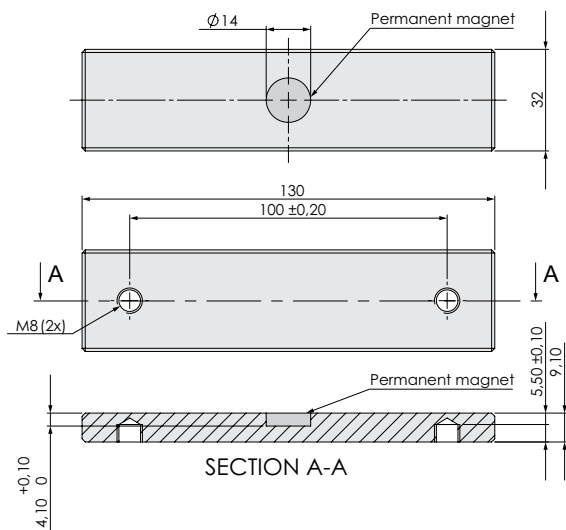

All dimensions in mm

Contact us

ABB AB

Jokab Safety

Varlabergsvägen 11

SE-434 39 Kungsbacka

Tel. +46 (0) 21-32 50 00



www.abb.com/jokabsafety

Note

We reserve the right to make technical changes or modify the contents of this document without prior notice.

With regard to purchase orders, the agreed particulars shall prevail. ABB does not accept any responsibility whatsoever for potential errors or possible lack of information in this document.

We reserve all rights in this document and in the subject matter and illustrations contained therein. Any reproduction, disclosure to third parties or utilization of its contents – in whole or in parts – is forbidden without prior written consent of ABB.

Copyright© 2017 ABB

All rights reserved