

Process lock

Dalton

Dalton is a compact electromechanical lock intended for locking doors and hatches. In the unlocked state the hatch is held closed by a ball catch, and in locked state the balls are mechanically blocked so the hatch cannot be opened.

Dalton is usually used to prevent unwanted process interruptions, e.g. during a welding operation.

Dalton can be used alone or with an Eden safety sensor that makes it easy to achieve PL e/SIL3 for the interlocking function. Dalton is available with an M12-connector for direct connection of Eden, to reduce cabling.



Easy to install

M12 connectors

Quick and easy cabling with M12 connectors.

Compact size

Dalton is easy to fit due to its low weight and compact size.

Modular structure

Dalton has a modular structure and can be combined in different ways depending on position, installation and function.



Continuous operation

LED diagnostics

Integrated LED diagnostics reduces downtime when troubleshooting.

Robust design

With an IP64 enclosure in anodized aluminum and a tongue in stainless steel, Dalton keeps your machine running in demanding environments.



Safety and protection

Safety interlocking

Easy connection to Eden sensor enables the highest level of safety for the interlocking function.

Applications and features

Dalton

Applications

Protection of the process

When used with Eden safety sensor, Dalton is a process lock, since the Eden sensor provides a safe interlocking function. This means that the interlocking function can reach PL e/SIL3 but the unlocking signal is not a safe signal. A typical application is on a hatch to prevent unintentional/unnecessary interruptions of a sensitive process when the dangerous movement has a very short stop time.

Dalton without Eden is a lock without any interlocking function/safety function.

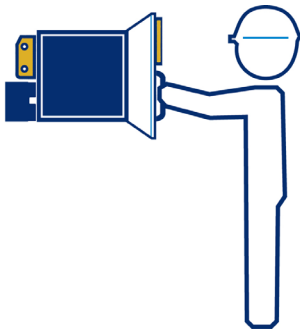

Locking and interlocking

An interlocking function indicates if a door is open or closed and prevents the machine from running when the door is open. But it does not prevent the door from being opened. A locking function makes sure the door is kept closed.

Features

PL e in a simple and cost effective way

The use of an Eden safety sensor together with Dalton makes it easy to reach PL e/SIL3 for the interlocking function. Eden can be mounted separately on the door/hatch or directly on Dalton M12. Both Eden DYN and Eden OSSD can be used.

When Eden DYN is used, a Tina 12A can be used to simplify the serial connection of two Dalton M12 locks. This reduces cabling and minimizes the risk of connection errors.



M12 connectors

Dalton M12 is equipped with an extra M12 connector for direct connection of an Eden safety sensor. This reduces cabling so that only one cable is necessary for both the locking of Dalton and the interlocking with Eden.

The M12 connectors speed up connection and reduce the risk of connection errors.



Status indication

All models offer an info signal indicating whether Dalton is locked or not, which simplifies troubleshooting and improves user friendliness.

Ordering information

Dalton

Ordering details

Go through the three steps below in order to select the necessary parts of a complete Dalton lock.

1. Choose a lock housing

Connector for Adam	Type of connector	Type	Order code
No (only locking function)	M12-8 male ²⁾	Dalton M11	2TLA020038R3100
	M12-5 male ²⁾	Dalton M31	2TLA020038R3300
Yes ¹⁾	M12-8 male (+ M12-5 female for Adam)	Dalton M12	2TLA020038R3200

- The compatible models are Adam DYN-Info M12-5, Adam DYN-Status M12-5, Adam OSSD-Info M12-5 and Adam OSSD-Reset M12-5.
- Dalton M11 and Dalton M31 offer the same function and the same number of signals. The choice between the two is mainly depending on the type of cable that is standard on site, with 5 or 8 leads.



Dalton M11

2TLCO10087V0201



Dalton M31

2TLCO10091V0201



Dalton M12

2TLCO10089V0201

2. Choose a lock tongue

Description	Type	Order code
Door closing to the front of Dalton	Lock tongue A	2TLA020039R0800
Door closing to the upper or lower side of Dalton	Lock tongue B	2TLA020039R1000

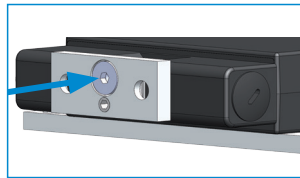

Door closing to the front of Dalton - Tongue A

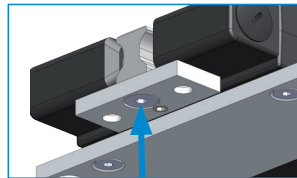

Door closing to the lower side of Dalton - Tongue B

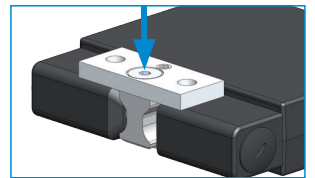

Door closing to the upper side of Dalton - Tongue B

3. Choose a fixing kit

Description	Type	Order code
For Dalton and lock tongue.	Dalton fixing kit 1	2TLA020039R0000
For Dalton and lock tongue plus Eden sensor.	Dalton fixing kit 2	2TLA020039R0100

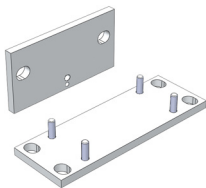

Fixing kit 1
For Dalton and lock tongue.
NOTE! Lock tongue is NOT included.

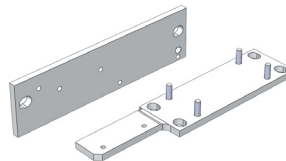

Fixing kit 2
For Dalton, lock tongue and Eden sensor.
NOTE! Eden and lock tongue are NOT included.

Ordering information

Accessories



2TLC172920F0201

M12-CT0214



2TLC172489F0201

Tina 12A

Accessories

Description	Type	Order code
Transfer cable M12-8 to M12-5, used e.g. for Dalton to Tina 4A or Tina 8A.	M12-CT0214	2TLA020060R0100
Connection block for series connection of two locks. E.g. Knox (M12-8), Magne or Dalton M12 with Eden DYN.	Tina 12A	2TLA020054R1800



M12-C61

2TLC172951F0201



M12-C61HE

2TLC010003F0201



M12-C334

2TLC172931F0201

Cable with connectors

Connector	Female/male	Length	Special feature	Type	Order code
M12-5	Female	6 m		M12-C61	2TLA020056R0000
			Harsh environment, halogen free	M12-C61HE	2TLA020056R8000
		10 m		M12-C101	2TLA020056R1000
			Harsh environment, halogen free	M12-C101HE	2TLA020056R8100
	Female + male	0.3 m		M12-C201	2TLA020056R1400
				M12-C0312	2TLA020056R5800
		0.06 m		M12-C00612	2TLA020056R6300
				M12-C112	2TLA020056R2000
		1 m		M12-C312	2TLA020056R2100
				M12-C612	2TLA020056R2200
		10 m		M12-C1012	2TLA020056R2300
			Angled female connector	M12-C1012V2	2TLA020056R6700
		16 m		M12-C1612	2TLA020056R5400
				M12-C2012	2TLA020056R2400
M12-8	Female	6 m		M12-C63	2TLA020056R3000
		10 m		M12-C103	2TLA020056R4000
		20 m		M12-C203	2TLA020056R4100
	Female + male	0.06 m		M12-C00634	2TLA020056R6400
				M12-C134	2TLA020056R5000
		1 m		M12-C334	2TLA020056R5100
			3 m		M12-C334

Separate cables and connectors

Description	Type	Order code
Connectors		
M12-5 pole female, straight	M12-C01	2TLA020055R1000
M12-5 pole male, straight	M12-C02	2TLA020055R1100
M12-8 pole female, straight	M12-C03	2TLA020055R1600
M12-8 pole male, straight	M12-C04	2TLA020055R1700



2TLC172657F0201

M12-C01



2TLC010038F0201

C5 cable

Cable with 5 conductors

10 m cable with 5 x 0.34 shielded conductors	C5 cable 10 m	2TLA020057R0001
50 m cable with 5 x 0.34 shielded conductors	C5 cable 50 m	2TLA020057R0005
100 m cable with 5 x 0.34 shielded conductors	C5 cable 100 m	2TLA020057R0010
200 m cable with 5 x 0.34 shielded conductors	C5 cable 200 m	2TLA020057R0020
500 m cable with 5 x 0.34 shielded conductors	C5 cable 500 m	2TLA020057R0050

Cable with 8 conductors

50 m cable with 8 x 0.34 shielded conductors	C8 cable 50 m	2TLA020057R1005
100 m cable with 8 x 0.34 shielded conductors	C8 cable 100 m	2TLA020057R1010
200 m cable with 8 x 0.34 shielded conductors	C8 cable 200 m	2TLA020057R1020
500 m cable with 8 x 0.34 shielded conductors	C8 cable 500 m	2TLA020057R1050

Technical data

Dalton

Technical data

Approvals		
Conformity	CE 2004/108/EC - EMC EN 61000-6-4:2007, EN 61000-6-2:2005	
Functional safety data	IEC/EN 61508-1...7 EN 62061 EN ISO 13849-1	Interlocking function (with Eden): SIL3, $PFH_D = 4.50 \times 10^{-9}$ Interlocking function (with Eden): SILCL3, $PFH_D = 4.50 \times 10^{-9}$ Interlocking function (with Eden): PL e, Cat. 4, $PFH_D = 4.50 \times 10^{-9}$
Electrical data		
Operating voltage		+24 VDC +25/-20%
Holding force		
Unlocked		25-100 N
Locked		2000 N
Mechanical data		
Operating temperature		-10...+55°C
Protection class		IP64
Material		
Ball catch, securing plate		Anodized aluminum
Enclosure		Anodized aluminum
Lock tongue, securing plate		Stainless steel

More information

For more information, e.g. the complete technical information, see product manual for:
 Dalton [2TLC172165M0201](#)

Dimension drawings

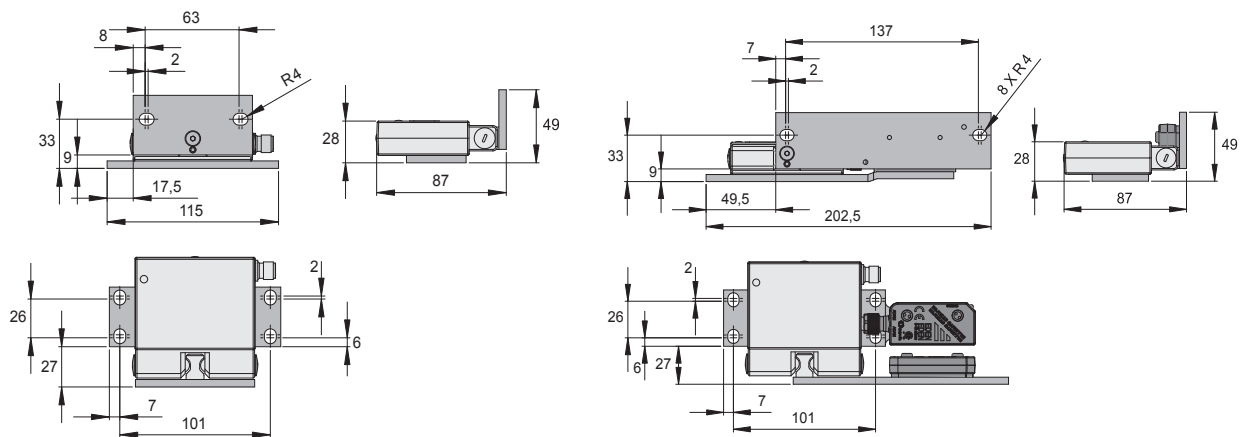

Fixing kit 1 with Dalton

Fixing kit 2 with Dalton and Eden

All dimensions in mm

Contact us

ABB AB

Jokab Safety

Varlabergsvägen 11

SE-434 39 Kungsbacka

Tel. +46 (0) 21-32 50 00



www.abb.com/jokabsafety

Note

We reserve the right to make technical changes or modify the contents of this document without prior notice.

With regard to purchase orders, the agreed particulars shall prevail. ABB does not accept any responsibility whatsoever for potential errors or possible lack of information in this document.

We reserve all rights in this document and in the subject matter and illustrations contained therein. Any reproduction, disclosure to third parties or utilization of its contents – in whole or in parts – is forbidden without prior written consent of ABB.

Copyright© 2017 ABB

All rights reserved