

SIEMENS

Control wire tap for busbar

Hilfsleiteranschlußklemme für Schienenanschluss

Bornes de raccordement des conducteurs auxiliaires pour raccordement sur barres

Borne de conductores aux. para conexión de barras

Morsetto del conduttore ausiliario per allacciamento binari

Borne de conexão para condutor auxiliar para conexão de barras

ray bağlantısı için yardımcı iletken bağlantı klemensi

Зажим вспомогательного провода для шинного подключения

Pomocniczy zacisk przyłączeniowy do przyłączenia szyn

轨道式端子的辅助导体接线端子

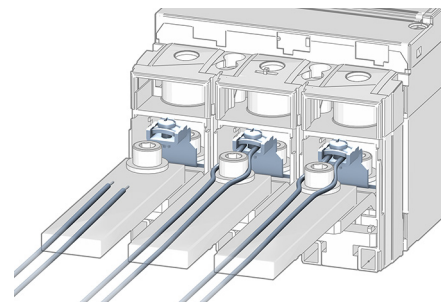

3VA9.70-0WC00



Operating Instructions Betriebsanleitung

Instruções de Serviço İşletme kılavuzu

Notice d'utilisation

Руководство по эксплуатации

Instructivo

Instrukcja obsługi

Istruzioni operative

使用说明

		EN DANGER Hazardous voltage. Will cause death or serious injury. Turn off and lock out all power supplying this device before working on this device. Replace all covers before power supplying this device is turned on.
		NOTICE Installation and maintenance must be carried out by qualified personnel.
DE GEFAHR Gefährliche Spannung. Lebensgefahr oder schwere Verletzungsgefahr. Bevor Arbeiten am Gerät durchgeführt werden, müssen alle Stromquellen ausgeschaltet und mit einer Einschaltssicherung versehen werden. Vor dem Wiedereinschalten der Stromquellen müssen alle Abdeckungen wieder angebracht werden.	FR DANGER Tension électrique dangereuse. Danger de mort ou risque de blessures graves. Avant d'intervenir sur l'appareil, couper toutes les sources de tension et les consigner contre la refermeture. Remettre en place tous les couvercles avant de remettre l'appareil sous tension.	
HINWEIS Installations- und Wartungsarbeiten sind von qualifiziertem Personal durchzuführen.	NOTIFICATION L'installation et la maintenance doivent être effectuées uniquement par des personnes qualifiées.	
ES PELIGRO Tensión peligrosa. Puede causar la muerte o lesiones graves. Antes de trabajar en este dispositivo, desconecte y bloquee todas las fuentes que lo alimentan eléctricamente. Recoloque todas las cubiertas antes de volver a conectar la alimentación eléctrica para este dispositivo.	IT PERICOLO Tensione pericolosa. Può causare la morte o lesioni gravi. Prima di lavorare su questa apparecchiatura, disinserire tutte le fonti di alimentazione elettrica dell'apparecchiatura ed assicurarle contro la reinserzione. Riapplicare tutte le coperture prima di reinserire l'alimentazione di questa apparecchiatura.	
NOTA La instalación y el mantenimiento deben corre a cargo de personal cualificado.	NOTA L'installazione e la manutenzione devono essere eseguite da personale qualificato.	
PT PERIGO Tensão perigosa. Perigo de morte ou ferimentos graves. Desligue e bloqueie todas as fontes de alimentação antes de executar quaisquer trabalhos no aparelho. Volte a colocar todas as coberturas antes de voltar a ligar as fontes de alimentação.	TR TEHLİKE Tehlikeli gerilim. Ölüm tehlikesi veya ağır yaralanma tehlikesi mevcuttur. Cihazda çalışmalar yapılmadan önce, tüm güç kaynakları kapatılmalı ve bir açma emniyetiyle donatılmalıdır. Güç kaynakları tekrar açılmadan önce tüm kapaklar yerlerine takılmalıdır.	
ATENÇÃO A instalação e manutenção têm de ser efetuadas por pessoal qualificado.	NOT Montaj ve bakım işlemleri kalifiye personel tarafından yapılmalıdır.	
РУ ОПАСНО Опасное напряжение. Опасность для жизни или телесных повреждений. До начала работы выключите и заблокируйте все источники питания этого устройства. Перед включением питания снова установите все крышки.	PL ZAGROŻENIE Niebezpieczne napięcie. Niebezpieczeństwo poważnych obrażeń lub utraty życia. Wyłączyć i zablokować wszystkie źródła zasilania urządzenia przed rozpoczęciem pracy na urządzeniu. Założyć wszystkie osłony przed podłączeniem urządzenia do źródła zasilania.	
ПРИМЕЧАНИЕ Установка и техническое обслуживание должны производиться квалифицированным персоналом.	UWAGA Instalacja i konserwacja muszą być wykonywane przez wykwalifikowany personel.	

Technical Support:

Internet: <http://www.siemens.com/lowvoltage/technical-support>

<p>中  危险</p> <p>危险电压。可能导致生命危险或重伤危险。操作此设备前必须确保切断其电源并采取防接通保护措施。在设备接通电源前，更换所有盖板。</p>	<p>HR  OPASNOST</p> <p>Opasni napon. Opasnost po život ili opasnost od teških ozljeda. Prije rada na uređaju potrebno je isključiti sve izvore struje i osigurati uređaj zaštitom od uključivanja. Prije ponovnog uključivanja izvora struje potrebno je opet postaviti sve poklopce.</p>
<p> 注意</p> <p>安装和维护必须由具备专业资质的人员进行。</p>	<p> НАРОМЕНА</p> <p>Montažu i održavanje treba obavljati kvalificirano osoblje.</p>
<p>FI  VAARA</p> <p>Vaarallinen jännite. Vakava loukkaantumisvaara tai hengenvaara. Laitteen kaikki virransyöttö tulee katkaista ja sen kytkeytyminen päälle tulee estää lukolla ennen kuin laitteeseen kohdistetaan mitään toimenpiteitä. Kaikki kotelot tulee kiinnittää takaisin ennen kuin laitteen virransyöttö kytketään uudelleen päälle.</p>	<p>БГ  ОПАСНОСТ</p> <p>Опасно напряжение. Опасност за живота или опасност от тежки телесни повреди. Преди да извършвате дейности по устройството, изключете и обезопасете всички захранващи източници. Поставете всички капацити на мястото им, преди отново да включите захранването на устройството.</p>
<p> HUOMAUTUS</p> <p>Asennus- ja huoltotyöt on annettava pätevän ammattilaisen suoritttaviksi.</p>	<p> ПРЕДУПРЕЖДЕНИЕ</p> <p>Инсталирането и поддръжката трябва да се извършват от квалифициран персонал.</p>
<p>EE  OHT</p> <p>Ohtlik pinge. Oht elule või raskete vigastuste oht. Enne seadme hooldustööd lülitage kõik toiteallikad välja ja võtke meetmed nende sisselülitamise takistamiseks. Enne toiteallikate uuesti sisselülitamist tuleb kõik katted tagasi paigaldada.</p>	<p>LV  BĪSTAMI</p> <p>Bīstams spriegums. Letālu seku vai smagu traumu risks. Pirms veicat darbu ar šo ierīci pilnībā izslēdziet un nobloķējiet tās strāvas padevi. Pirms ieslēdzat ierīces strāvas padevi uzlieciet atpakaļ visus pārsegus.</p>
<p> MÄRKUS</p> <p>Paigaldus- ja hooldustööd tohib teha ainult kvalifitseeritud personal.</p>	<p> BRĪDINĀJUMS</p> <p>Uzstādīšana un tehniskā apkope jāveic kvalificētiem darbiniekiem.</p>
<p>LT  PAVOJUS</p> <p>Pavojinga įtampa. Pavojus gyvybei arba sunkausi susižalojimo pavojus. Prieš dirbdami ties šiuo prietaisu, išjunkite ir užblokuokite visus šio prietaiso maitinimo šaltinius. Prieš jungdami šio prietaiso maitinimo šaltinį, vėl uždėkite visus dangčius.</p>	<p>DA  FARE</p> <p>Farlig spænding. Livsfare eller risiko for slemme kvæstelser. Sluk for og lås strømmen, der forsyner denne enhed, før du arbejder med denne enhed. Erstat alle afdækninger, før strømmen, der tilføres denne enhed, tændes.</p>
<p> NUORODA</p> <p>Įrengimą ir techninę priežiūrą turi vykdyti kvalifikuoti darbuotojai.</p>	<p> BEMÆRK</p> <p>Installationen og vedligeholdelsen skal foretages af uddannet personale.</p>
<p>MT  PERIKLU</p> <p>Vultaġġ perikoluż. Riskju ta' mewt jew korriment serju. Qabel taħdem fuq dan l-apparat, itfi kull provvista tal-elettriku tiegħu u sakkar kontra xegħil mill-gdid aċċidentali. Erġa' installa l-ghotjien kollha qabel tirritorna l-provvista tal-elettriku fl-apparat.</p>	<p>NL  GEVAAR</p> <p>Gevaarlijke spanning. Levensgevaar of gevaar voor ernstig letsel. Voordat u aan dit apparaat werkt, moet u alle actieve energiebronnen voor dit apparaat uitschakelen. Plaats alle afdekkingen terug voordat u energiebronnen voor dit apparaat inschakelt.</p>
<p> AVVIŻ</p> <p>L-installazzjoni u l-manutenzjoni għandhom jittwettqu minn personal ikkwalifikat.</p>	<p> OPMERKING</p> <p>Installatie en onderhoud moeten worden verricht door gekwalificeerd personeel.</p>
<p>EL  ΚΙΝΔΥΝΟΣ</p> <p>Επικίνδυνη τάση. Κίνδυνος για τη ζωή ή σοβαρού τραυματισμού. Απενεργοποιήστε και ασφαλίστε όλη την ενέργεια που τροφοδοτεί τη συσκευή, προτού εργαστείτε σε αυτή. Τοποθετήστε ξανά όλα τα καλύμματα, προτού ενεργοποιήσετε την τροφοδοσία της συσκευής με ενέργεια.</p>	<p>GA  CONTÚIRT</p> <p>Voltaas contúirteach. Baol go bhfaighfear bás nó tromghortú. Múch gach cumhacht a sholáthraíonn an gléas seo agus glasáil amach í roimh obair a dhéanamh ar an ngléas seo. Cuir na clúdaigh ar fad ar ais roimh an gcumhacht a sholáthraíonn an gléas seo a chur ar siúl arís.</p>
<p> ΠΡΟΣΟΧΉ</p> <p>Η εγκατάσταση και συντήρηση πρέπει να διεξάγονται από εξειδικευμένο προσωπικό.</p>	<p> FÓGRA</p> <p>Ní mór don fheistiú agus don chothabháil a bheith déanta ag pearsanra cáilithe.</p>
<p>RO  PERICOL</p> <p>Tensiune periculoasă. Pericol de moarte sau de accidentări grave. Opriti și blocați alimentarea cu energie a acestui dispozitiv înainte de a lucra la acesta. Așezați la loc toate capacele înainte de a porni alimentarea cu energie a acestui dispozitiv.</p>	<p>SV  FARA</p> <p>Farlig spänning. Livsfara eller risk för allvarliga personskador. Innan arbete utförst på utrustningen ska strömförsörjningen till utrustningen stängas av. Montera alla skyddsplåtar igen innan utrustningen slås på.</p>
<p> ÎNȘTIINȚARE</p> <p>Instalarea și întreținerea trebuie să se efectueze de către personalul calificat.</p>	<p> OBS</p> <p>Installation och underhåll får endast utföras av kvalificerad personal.</p>
<p>CZ  NEBEZPEČÍ</p> <p>Nebezpečné napětí. Nebezpečí smrtelného nebo těžkého úrazu. Před zahájením prací na tomto zařízení odpojte a zajistěte veškeré přírůdy energie. Před opětovným připojením zařízení vraťte všechny kryty na svá místa.</p>	<p>SL  NEVARNOST</p> <p>Nevarna napetost. Nevarnost za življenje ali nevarnost hudih poškodb. Izklopite in prekinite celotno napajanje naprave, preden na njej opravljate dela. Preden napajanje znova vklopite, namestite vse pokrove.</p>
<p> POZNÁMKA</p> <p>Instalaci a údržbu musí provádět kvalifikovaní pracovníci.</p>	<p> OPOMBA</p> <p>Namestitev in vzdrževanje mora opraviti usposobljeno osebje.</p>
<p>SK  NEBEZPEČENSTVO</p> <p>Nebezpečné napätie. Nebezpečenstvo ohrozenia života alebo vzniku ťažkých zranení. Pred prácou na zariadení vypnite a zaistite všetky napájacie prípojky tohto zariadenia. Pred zapnutím napájania tohto zariadenia najprv nasad'te späť všetky kryty.</p>	<p>HU  VESZÉLY</p> <p>Veszélyes feszültség. Életveszély vagy súlyos sérülésveszély. Mielőtt bármilyen munkavégzést kezd az eszközön, az áramellátást le kell kapcsolni, és véletlen bekapcsolás elleni védelemmel kell ellátni. Az áramellátás visszakapcsolása előtt minden burkolatot vissza kell helyezni.</p>
<p> UPOZORNENIE</p> <p>Inštaláciu a údržbu musí vykonávať kvalifikovaný personál.</p>	<p> MEGJEGYZÉS</p> <p>A telepítést és a karbantartást kizárólag szakképzett személyzet végezheti.</p>



EN

⚠ DANGER

Hazardous voltage. Will cause death or serious injury. Turn off and lock out all power supplying this device before working on this device. Replace all covers before power supplying this device is turned on.

ES

⚠ PELIGRO

Tensión peligrosa. Puede causar la muerte o lesiones graves. Antes de trabajar en este dispositivo, desconecte y bloquee todas las fuentes que lo alimentan eléctricamente. Recoloque todas las cubiertas antes de volver a conectar la alimentación eléctrica para este dispositivo.

FR

⚠ DANGER

Tension électrique dangereuse. Danger de mort ou risque de blessures graves. Avant d'intervenir sur l'appareil, couper toutes les sources de tension et les consigner contre la refermeture. Remettez en place tous les couvercles avant de remettre l'appareil sous tension.



Required tools / Notwendige Werkzeuge / Outils nécessaires / Herramientas requeridas / 必要工具



cal. ISO 6789



Contents / Lieferumfang / Etendue de la livraison / Alcance de suministro / 供货范围



		10x		10x	
3VA5	250	3VA9270 - 0WC00		—	
3VA6	150 / 250	—		3VA9470 - 0WC00	
	400 / 600	—		3VA9470 - 0WC00	



Assembly / Montage / Montage / Montaje / 安装

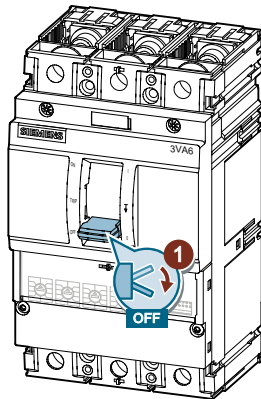

3VA5/6	150 / 250	6	175 [20]
3VA6	400 / 600	8	355 [40]
3VA914.-0K.00	150 / 250	6	175 [20]

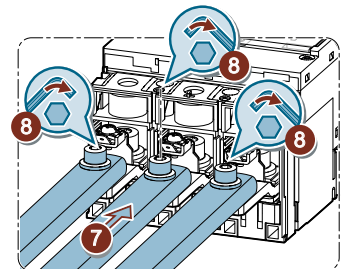
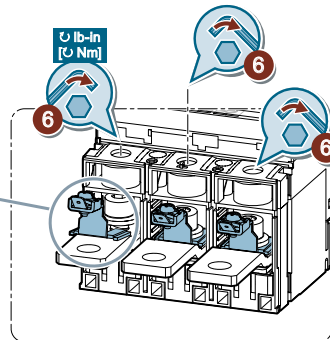
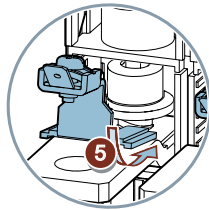
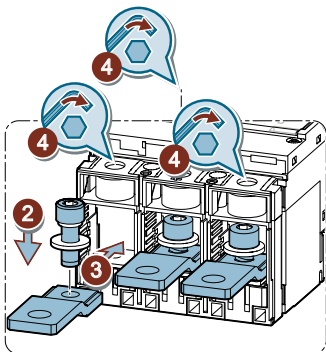



EN	NOTICE	DE	HINWEIS
Control wire terminal current not to exceed 15 A continuous. Provide control wire overcurrent protection.		Der Klemmenstrom der Steuerleitung darf dauerhaft 15 A nicht übersteigen. Sorgen Sie für einen Überstromschutz für die Steuerleitung.	
FR	NOTIFICATION	ES	NOTA
Courant max. permanent sur les conducteurs de commande 15 A. Équiper les conducteurs de commande d'une protection de surintensité.		La corriente por el borne del conductor de control no debe superar permanentemente 15 A. Instale protección de sobrecorriente para el conductor.	
IT	AVVERTENA	PT	ATENÇÃO
La corrente per i morsetti dei cavi di controllo non deve superare permanentemente 15 A. Prevedere una protezione da sovracorrente per il cavo di controllo.		A corrente do terminal do cabo de comando não pode exceder permanentemente 15 A. Providenciar proteção de corrente máxima para o cabo de comando.	
TR	NOT	PV	ПРИМЕЧАНИЕ
Kontrol kablosu terminal akımı 15 A değerini sürekli olarak aşmamalıdır. Kontrol kablosu aşırı akım koruması sağlayın.		Ток на клемме провода управления не должен непрерывно превышать 15 А. Обеспечьте защиту от перегрузки провода управления.	
PL	UWAGA	中	提示
Napięcie przewodu sterowania nie może przekraczać 15 A prądu stałego. Zapewnić zabezpieczenie nadmiarowo-prądowe.		控制线端子的电流始终不得超过 15 A。提供控制线过电流保护。	
HR	NAPOMENA	FI	HUOMAUTUS
Struja stezaljki upravljačkog voda ne smije kontinuirano prelaziti 15 A. Pobrinite se za nadstrujnu zaštitu upravljačkog voda.		Ohjaukskaapelin liittimen jatkuva virta saa olla enintään 15 A. Varusta ohjaukskaapeli ylivirtasuojalla.	
БГ	ПРЕДУПРЕЖДЕНИЕ	EE	MÄRKUS
Номиналното напрежение в контролния кабел не трябва да надвишава 15 А. Осигурете защита срещу претоварване на контролния кабел.		Juhtiva juhtmeklemmi vool ei tohi ületada 15 A pidevvoolu. Kindlustage juhtkaabli liigvoolukaitse.	
LV	BRĪDINĀJUMS	LT	NUORODA
Kontroles vada spaiļes strāva nedrīkst ilgstoši pārsniegt 15 A. Nodrošiniet kontroles vadam aizsardzību pret strāvas pārslodzi.		Valdymo laido gnybto srovė neturi nepertraukiamai viršyti 15 A. Parūpinkite valdymo laidui apsaugą nuo viršsrovio.	
DA	BEMÆRK	MT	AVVIŻ
Styrettilslutningsterminalstrøm må ikke overstige 15 A kontinuerligt. Sørg for styrettilslutnings-overstrømsbeskyttelse		Il-kurrent fit-terminal tal-wajer ta' kontroll m'għandux jeċċedi 15 A kontinwament. Ipprovdvi protezzjoni kontra kurrent eċċessiv fil-wajer ta' kontroll.	
NL	OPMERKING	EL	ΠΡΟΣΟΧΉ
De stroom aan de regeldraadaansluiting mag niet continu hoger zijn dan 15 A. Overstroombeveiliging voor de regeldraad voorzien.		Το ρεύμα στη σύνδεση βοηθητικού αγωγού δεν επιτρέπεται να υπερβαίνει μόνιμα τα 15 Α. Να προβλέπεται προστασία από υπερένταση για τον βοηθητικό αγωγό.	
GA	FÓGRA	RO	ÎNȘTIINȚARE
Ná lig do shruth teirminéal na sreinge rialaithe 15 A leanúnach a shárú. Cuir cosaint fhorshrutha sreinge rialaithe ar fáil.		Curentul la borna conductorului de comandă nu trebuie să depășească 15 A c.c. Trebuie prevăzută protecție la supracurent la conductorul de comandă.	
SV	OBS	SK	UPOZORNENIE
Styrkabelns terminalspänning får ej kontinuerligt överskrida 15 A. Installera ett överspänningskydd för styrkabeln.		Prúd v svorke riadiaceho vodiča nemá byť trvalo vyšší ako 15 A. Zabezpečte nadprúdovú ochranu riadiaceho vodiča.	
SL	OPOMBA	CZ	POZNÁMKA
Tok priključka krmilnega vodnika ne sme trajno presežati 15 A. Poskrbite za nadtokovno zaščito krmilnega vodnika.		Proud na konektoru ovládacího vodiče nesmí dlouhodobě překročit 15 A. Ovládací vodič opatřete proudovou ochranou.	
HU	MEGJEGYZÉS		
A vezérlővezeték záró áramerőssége nem haladhatja meg folyamatosan a 15 A értéket. Gondoskodjon a vezérlővezeték túláram elleni védelméről.			



EN

⚠ DANGER

Hazardous voltage. Will cause death or serious injury. Turn off and lock out all power supplying this device before working on this device. Replace all covers before power supplying this device is turned on.

ES

⚠ PELIGRO

Tensión peligrosa. Puede causar la muerte o lesiones graves. Antes de trabajar en este dispositivo, desconecte y bloquee todas las fuentes que lo alimentan eléctricamente. Recoloque todas las cubiertas antes de volver a conectar la alimentación eléctrica para este dispositivo.

FR

⚠ DANGER





Tension électrique dangereuse. Danger de mort ou risque de blessures graves. Avant d'intervenir sur l'appareil, couper toutes les sources de tension et les consigner contre la refermeture. Remettez en place tous les couvercles avant de remettre l'appareil sous tension.

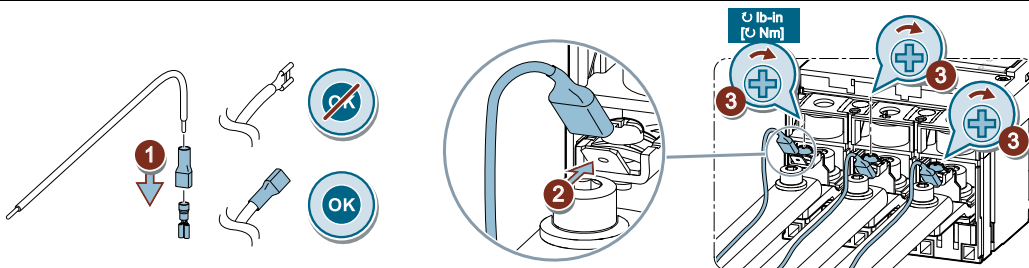
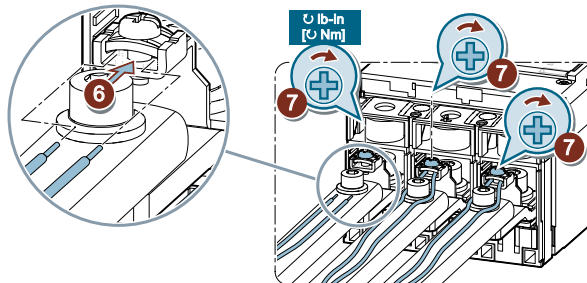
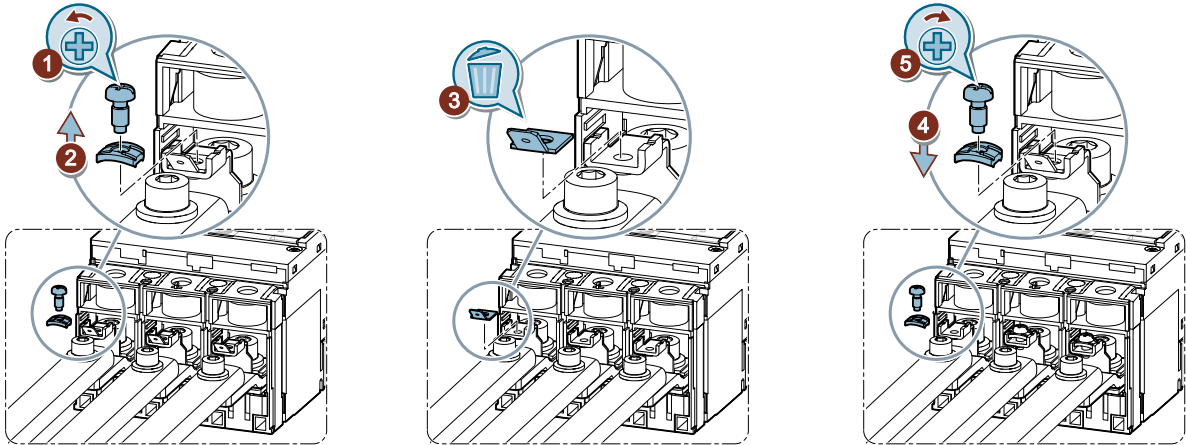



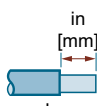













Connection / Anschluss / Raccordement / Conexión / 连接





	 AWG [mm ²]	 L	I / A	 18 lb-in [2 Nm]
	1 x (18 - 14) 2 x 18 2 x 16 2 x 14 [1 x (0.75 - 2.5) 2 x 0.75 2 x 1.0 2 x 1.5 2 x 2.5]	0.4 [10]	≤ 15	18 [2.0]
	1 x (18 - 14) [1 x (0.75 - 2.5)]			

	EN  DANGER Arcing hazard. Will cause death or serious injury. One barrier method must be applied, as noted in the breaker instructions, per the specific application parameters.
DE  GEFAHR Lichtbogengefahr. Lebensgefahr oder schwere Verletzungsgefahr. Wie in der Anleitung zum Leistungsschalter ausgeführt, muss entsprechend der spezifischen Anwendungsparameter eine Sperrmethode verwendet werden.	FR  DANGER Danger d'arc. Danger des mort ou risque de blessures graves. Une méthode d'isolation correspondant à l'application doit être mise en œuvre comme indiqué dans la notice du disjoncteur.
ES  PELIGRO Peligro de arco eléctrico Puede causar la muerte o lesiones graves. Es preciso usar un método de aislamiento contra contactos directos como se indica en la instrucciones de interruptor, considerando además los parámetros de la aplicación específica.	IT  PERICOLO Pericolo di formazione d'arco elettrico. Può provocare la morte o gravi lesioni. Come indicato nelle Istruzioni operative dell'interruttore automatico, si deve utilizzare un metodo di isolamento conformemente al tipo di applicazione specifico.
PT  PERIGO Perigo de formação de arco voltaico. Perigo de morte ou ferimentos graves. É necessário aplicar um método de barreira de separação, como referido nas instruções do disjuntor, de acordo com os parâmetros de aplicação específicos.	TR  TEHLİKE Kıvılcım tehlikesi. Ölüm ya da ciddi yaralanmaya sebebiyet verir. Kesici talimatlarında belirtildiği gibi, özel uygulama parametreleri ile bir bariyer yöntemi uygulanmalıdır.
РУ  ОПАСНО Опасность электрической дуги. Может привести к смерти или серьезным травмам. Должен применяться один из методов барьеров, указанных в руководстве выключателя, в соответствии со специфическими параметрами приложения.	PL  ZAGROŻENIE Ryzyko wyładowań łukowych. Mogą powodować utratę życia lub poważne obrażenia. Należy zastosować jedną z metod ochronnych dla określonych parametrów zastosowania, jak przedstawiono w instrukcji wyłącznika.
中  危險 电弧危险。将导致死亡或重伤。 必须根据特定应用参数应用一种屏障方法，如断路器说明中所述。	HR  OPASNOST Opasnost od iskrenja. Opasnost po život ili opasnost od teških ozljeda. Potrebno je primijeniti metodu jedne prepreke, kako je navedeno u uputama za prekidač, u skladu s određenim primjenjivim parametrima.
FI  VAARA Valokaaren vaara. Seurauksena on vakava loukkaantuminen tai kuolema. Jonkin eristyskeinon käyttö on pakollista, ja se on toteutettava erityisten käyttöparametrien mukaisesti, kuten on kuvattu katkaisijan ohjeissa.	БГ  ОПАСНОСТ Опасност от електрическа дъга. Може да причини смърт или сериозни наранявания. Трябва да се използва метод с една преграда (както е указано в инструкциите за автоматичния прекъсвач) в съответствие с указанията и параметрите за конкретното приложение.
EE  OHT Keevituskaare oht. Võib olla eluohtlik või tekitada tõsiseid vigastusi. Kasutada tuleb ühte tõkestusmeetodit, nagu on märgitud kaitselüliti juhistes, vastavalt konkreetse rakenduse parameetritele.	LV  BĪSTAMI Lokizlādes risks. Izraisa nāvi vai smagus miesas bojājumus. Jāizmanto vienas barjeras metode, kā minēts pārtraucēja instrukcijās, ievērojot noteiktos lietojuma parametrus.

		EN	 DANGER
		Hazardous voltage. Will cause death or serious injury. Turn off and lock out all power supplying this device before working on this device. Replace all covers before power supplying this device is turned on.	
ES	 PELIGRO	FR	 DANGER
Tensión peligrosa. Puede causar la muerte o lesiones graves. Antes de trabajar en este dispositivo, desconecte y bloquee todas las fuentes que lo alimentan eléctricamente. Recoloque todas las cubiertas antes de volver a conectar la alimentación eléctrica para este dispositivo.		Tension électrique dangereuse. Danger de mort ou risque de blessures graves. Avant d'intervenir sur l'appareil, couper toutes les sources de tension et les consigner contre la refermeture. Remettez en place tous les couvercles avant de remettre l'appareil sous tension.	
LT	 PAVOJUS	DA	 FARE
Lanko susidarymo pavojus. Sukels mirtį arba rimtą sužalojimą. Konkretių naudojimo atvejų parametrus reikia taikyti, kaip nurodyta jungtuvo instrukcijoje, vieno barjero metodu.		Lysbud fare. Forårsager død eller alvorlige kvæstelser. Der skal anvendes en spærremetode som nævnt i afbryder-anvisningerne, efter de specifikke applikationsparametre.	
MT	 PERIKLU	NL	 GEVAAR
Periklu ta' arkjar (arcing). Dan jista' jikkawża mewt jew korrimenti gravi. Hekk kif deskritt fl-istruzzjonijiet tas-circuit breaker, għandu jiġi applikat metodu ta' qtugh tal-kurrent wieħed biss skont il-parametri speċifiċi tal-applikazzjoni.		Gevaar van vonken. Leidt tot de dood of ernstig letsel. Eén blokkeermethode moet worden toegepast, zoals vermeld in de stroomonderbrekerinstructies, via de specifieke toepassingsparameters.	
EL	 ΚΙΝΔΥΝΟΣ	GA	 CONTÚIRT
Κίνδυνος σπινθηρισμών. Προκαλείται θάνατος ή σοβαρός τραυματισμός. Όπως αναφέρεται στις οδηγίες διακόπτη, πρέπει να εφαρμόζεται μία μέθοδος φραγής για τις συγκεκριμένες παραμέτρους εφαρμογής.		Baol stuála. Beidh sé ina chúis bháis nó tromghortaithe Ní mór modh baic amháin a chur i bhfeidhm mar atá curtha in iúl sna tre-oracha scoradáin, de réir na sainpharaiméadair feidhmchláir.	
RO	 PERICOL	SV	 FARA
Pericol de arc electric. Acesta va provoca decesul sau o vătămare gravă. Trebuie să se aplice o metodă de barieră, așa cum prevăd instrucțiunile întrerupătorului, conform parametrilor aplicației respective.		Överslagsrisk. Kommer att orsaka dödsfall eller allvarliga personska- dor. En barriärmetod måste tillämpas enligt de specifika applikations- parametrarna, se uppgifterna i brytarens instruktioner.	
SK	 NEBEZPEČENSTVO	SL	 NEVARNOST
Nebezpečnost vzniku el. oblúka. Nebezpečnost ohrozenia života alebo vzniku vážnych zranení. Použitý musí byť jeden spôsob vytvorenia bariéry, podľa parametrov konkrétnej aplikácie, ako to je uvedené v návode na použitie pre vypínač.		Nevarnost iskrenja. Nevarnost za življenje ali nevarnost hudih poš- kodb. Metoda z eno blokado se mora uporabiti, kot je navedeno v navodi- lih odklopnika, glede na specifične parametre aplikacije.	
CZ	 NEBEZPEČÍ	HU	 VESZÉLY
Nebezpečí vzniku elektrického oblouku. Může způsobit usmrcení nebo vážné poranění. Podle pokynů pro jistič musí být použita metoda jedné bariéry, a to s ohledem na parametry konkrétní aplikace.		Ívkisülés veszélye. Halált vagy komoly sérülést okoz. Egy potenciálgát módszert kell alkalmazni a megszakító utasításokban leírtak szerint, az adott alkalmazási paramétereknek megfelelően.	

3VA5 250	3ZW1012-1VA10-3AA0	
	3ZW1012-1VA10-4AA0	
3VA6 150/250	3ZW1012-1VA20-0AA0	
	3ZW1012-1VA20-2AA0	
3VA6 400/600	3ZW1012-1VA23-1AA0	
	3ZW1012-1VA23-0AA0	

EN	NOTICE
<p>These instructions do not purport to cover all details or variations in equipment, or to provide for every possible contingency in connection with installation, operation, or maintenance. Should additional information be desired, please contact the local Siemens sales office. The contents of this instruction manual shall not become part of or modify any prior or existing agreement, commitment, or relationship. The sales contract contains the entire obligation of Siemens. The warranty contained in the contract between the parties is the sole warranty of Siemens. Any statements contained herein do not create new warranties or modify the existing warranty.</p> <p>Trademarks - Unless otherwise noted, all names identified by ® are registered trademarks of Siemens AG or Siemens Industry, Inc. The remaining trademarks in this publication may be trademarks whose use by third parties for their own purposes could violate the rights of the owner.</p>	