

Miniature Circuit Breakers

Configuration Manual · 10/2010

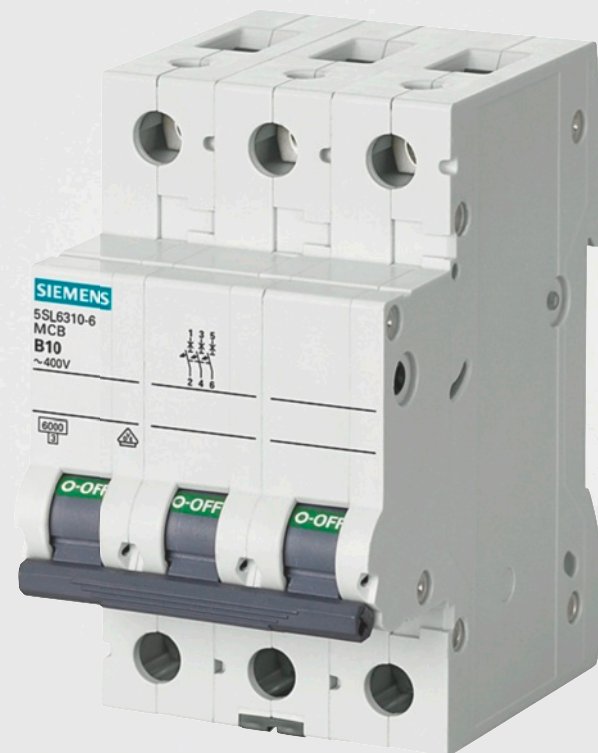

SENTRON

Answers for infrastructure.

SIEMENS

Miniature Circuit Breakers













4	Miniature Circuit Breakers Introduction
6	5SL6 miniature circuit breakers, 6000 A
7	5SY and 5SP miniature circuit breakers 5SY4, 5SY5, 5SP4, 5SP5, 10 kA; 5SY7, 15 kA; 5SY8, 25 kA
9	5SJ6 miniature circuit breakers Miniature circuit breakers with plug-in terminals, 5SJ6 ...-KS
10	Miniature circuit breakers 5SY6 0 1+N in 1 MW
12	Additional components
15	Busbars
15	Standard 5ST3 6, 5ST3 7
19	Acc. to UL 508, 5ST3 7 ...-HG
21	Configuration and dimensioning
47	Miniature circuit breakers 5SJ4 ...- HG and accessories, according to UL 489 and IEC
55	SHU 5SP3 main miniature circuit breakers
59	5SK9 circuit breaker terminals

Miniature Circuit Breakers

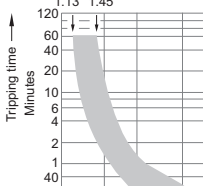
Introduction

Overview

Devices	Page	Application	Standards	Used in		
				Non-residential buildings	Residential buildings	Industry
	6	For all 0.3 to 63 A applications with B and C tripping characteristics with 6000 A rated switching capacity acc. to EN 60898-1.	EN 60898-1	✓	✓	✓
	7	For all applications from 0.3 to 125 A with a rated switching capacity of 10000 A and 15000 A acc. to EN 60898-1. Applications for universal current and from 0.3 to 63 A, Version 25 kA, acc. to EN 60947-2.	EN 60898-1/2 EN 60947-2	✓	✓	✓
	9	For socket outlet and lighting circuits in all building installations. The plug-in terminals offer easy front connection for manual insertion of conductors, which considerably reduces mounting times.	EN 60898-1	✓	✓	✓
	10	For socket outlet and lighting circuits in all building installations where a switchable neutral conductor is required. The miniature circuit breaker 1+N saves space in the distribution board.	EN 60898-1	✓	✓	✓
	12	Auxiliary switches, fault signal contacts, shunt trips, undervoltage releases for higher plant availability, RC units for personal safety and remote controlled mechanisms for remote switching.		✓	--	✓
	15	Busbars in 10 mm ² and 16 mm ² save space in the distribution board and time during mounting.		✓	✓	✓
	22	Notes for configuration, dimensioning and expanded technical specifications.				
	47	Miniature circuit breakers can be used as "branch circuit protection" and are approved for the connection type "same polarity" and "opposite polarity" in the characteristics B, C and D acc. to UL489, from 0.3 to 63 A.	UL 489	✓	✓	✓

Devices	Page	Application	Standards	Used in		
				Non-residential buildings	Residential buildings	Industry
 <p>SHU 5SP3 main miniature circuit breakers</p>	55	Voltage-independent selective main miniature circuit breakers (SHU) in the precounter sector support downstream miniature circuit breakers by providing better current limitation.	DIN VDE 0641-21	✓	✓	--
 <p>Circuit breaker terminals, 5SK9</p>	59	Circuit breaker terminals are used for short-circuit protection or for protection against overload and short circuits in auxiliary and control circuits downstream of control transformers.		--	--	✓

Miniature Circuit Breakers

5SL6 miniature circuit breakers, 6 000 A

Overview

The new 5SL miniature circuit breaker is intended for use up to 6 kA. The devices have the system features characteristic of all Siemens miniature circuit breakers.

The 5SL miniature circuit breakers can be used as main switches for the disconnection or isolation of plants. They are also suitable for the quick and easy mounting of additional components, such as auxiliary switches and fault signal contacts.

To facilitate cable entry, the devices are equipped with square terminals for the joint accommodation of pin busbars with cables from 0.75 mm² to 35 mm². The rated current range is between 0.3 and 63 A. The 5SL miniature circuit breakers are available in characteristics B and C.

Technical specifications

		5SL6	
Standards		EN 60898-1	
Approvals		http://www.siemens.com/lowvoltage/support	
Tripping characteristic		B, C	
Rated voltage U_n	V AC	230/400	
Operational voltage			
• Min.	V AC/DC	24	
• Max.	V AC	250/440	
• Max.	V DC/pole	60 ¹⁾	
Rated switching capacity I_{cn}	Acc. to EN 60898-1	kA AC	6
Insulation coordination			
• Rated insulation voltage	V AC	250/440	
• Pollution degree for overvoltage category		2/III	
Touch protection	Acc. to EN 50274	Yes	
Handle end position , sealable		Yes	
Degree of protection		IP20, with connected conductors	
CFC and silicone-free		Yes	
Conductor cross-sections			
• Solid and stranded	mm ²	0.75 ... 35	
• Finely stranded with end sleeve	mm ²	0.75 ... 25	
Terminals			
• Terminal tightening torque	Nm	2.5 ... 3	
Mounting position		any	
Service life , on average, with rated load		20000 actuations	
Ambient temperature	°C	-25 ... +45, occasionally +55, max. 95 % humidity, storage temperature: -40 ... +75	
Resistance to climate	Acc. to IEC 60068-2-30	6 cycles	
Resistance to vibrations	Acc. to IEC 60068-2-6	m/s ²	50 at 25 ... 150 Hz and 60 at 35 Hz (4 sec)

¹⁾ The operational voltage 60 V DC/pole takes into account a battery charging voltage with a peak value of 72 V.

Dimensional drawings

5SL6

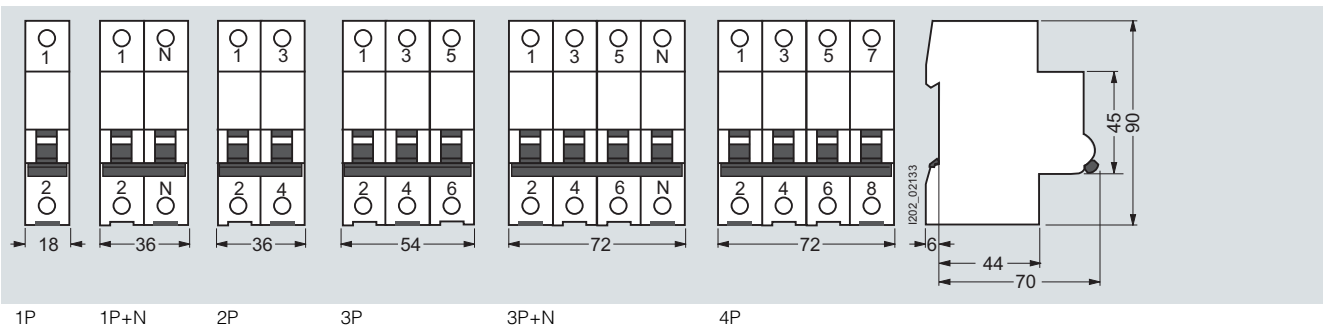

Schematics

Diagrams

5SL6

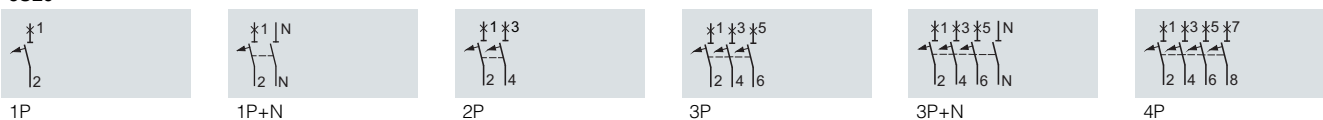

Miniature Circuit Breakers

5SY and 5SP miniature circuit breakers

5SY4, 5SY5, 5SP4, 5SP5, 10 kA;
5SY7, 15 kA; 5SY8, 25 kA

Overview

MCBs are used to protect plants in buildings and for industrial applications. The devices can be used as main control switches for the disconnection or isolation of plants.

Used in industrial applications and plant engineering, miniature circuit breakers can be supplemented with additional components, such as auxiliary switches, fault signal contacts, shunt trips, undervoltage releases, remote controlled mechanisms and RC units.

The devices are approved for worldwide use according to IEC standards for systems up to 250/440 V AC. 60 V DC per pole is permitted in DC systems.

For North America, we also have additional approval to UL 1077 for use as "supplementary protectors" in systems up to 480Y/277 V AC. For use in ship building, the devices also have numerous certifications according to shipping classifications; BV, DNV, GL and LRS. [Information on this can be found on the Internet: http://www.siemens.com/lowvoltage/support](http://www.siemens.com/lowvoltage/support)

Technical specifications

		5SY4	5SY5	5SY7	5SY8	5SP4	5SP5
Standards		EN 60898-1; EN 60947-2	EN 60898-2;	EN 60898-1; EN 60947-2	EN 60947-2	EN 60898-1; EN 60947-2	EN 60898-2
Approvals		http://www.siemens.com/lowvoltage/support					
Operational voltage	V AC	230/400	230/400	230/400	230/400	230/400	230/400
	V DC	--	220/440/880	--	--	--	220/440
Acc. to EN 60898-1/-2 and EN 60947-2	Min. V AC/DC	24	24	24	24	24	24
	Max. V DC/pole	60 ¹⁾	250	60 ¹⁾	60 ¹⁾	60 ¹⁾	250
Acc. to UL 1077 and CSA C22.2 No.235	Max. V AC	250/440	250/440	250/440	250/440	250/440	250/440
	Max. V AC V DC/pole	480Y/277 60	--	480Y/277 60	480Y/277 60	480Y/277 60	--
Rated switching capacity²⁾							
• I_{cn} acc. to IEC/EN 60898-1	kA AC	10	10	15	--	10	3
• I_{cn} acc. to IEC/EN 60898-2	kA DC	10	10	15	--	10	10
• I_{cu} acc. to IEC/EN 60947-2	kA AC	--	--	--	25	--	--
	kA DC	--	15	--	15	--	15
• Acc. to UL 1077 and CSA C22.2 No.235	kA AC	5	--	5	5	5	--
Insulation coordination							
• Rated insulation voltage	V AC V DC/pole	250/440 --	250	--	--	--	250
Pollution degree for overvoltage category		3/III					
Touch protection	Acc. to EN 50274	Yes					
Main switch characteristics	Acc. to EN 60204	Yes					
Handle end position, sealable		Yes					
Degree of protection	Acc. to EN 60529	IP20, with connected conductors					
CFC and silicone-free		Yes					
Mounting							
• Snap-on fixing system		Yes				--	
• Standard mounting rail and screw fixing		--				Yes	
Terminals							
• Tunnel terminals at both ends		--				Yes	
• Combined terminals at both ends		Yes				--	
• Terminal tightening torque	Nm lb. in	2.5 ... 3 22 ... 26				2.5 ... 3.5 22 ... 31	
Conductor cross-sections							
• Solid and stranded	mm ²	0.75 ... 35				0.75 ... 50	
• Finely stranded, with end sleeve	mm ²	0.75 ... 25				0.75 ... 35	
• AWG cables	AWG	14 ... 4				14 ... 2	
Mains connection							
• AC		Any					
• DC		Any	³⁾	Any			³⁾
Mounting position		Any					
Service life	Actuations	20000					
On average, with rated load	Actuations	For 5SY5 at 40 A, 50 A and 63 A 10000					
Ambient temperature	°C	-25 ... +45, occasionally +55, max. 95 % humidity					
Storage temperature	°C	-40 ... +75					
Resistance to climate	Acc. to IEC 60068-2-30	6 cycles					
Shock	Acc. to IEC 60068-2-27	m/s ² 150 at 11ms half-sine					
Resistance to vibrations	Acc. to IEC 60068-2-6	m/s ² 50 at 25 ... 150 Hz and 60 at 35 Hz (4 sec)					

¹⁾ The operational voltage 60 V DC/pole takes into account a battery charging voltage with a peak value of 72 V.

²⁾ For further information, see page 3/20.

³⁾ Ensure compliance with the specified polarity when connecting DC.

Miniature Circuit Breakers

5SY and 5SP miniature circuit breakers

5SY4, 5SY5, 5SP4, 5SP5, 10 kA;
5SY7, 15 kA; 5SY8, 25 kA

Dimensional drawings

5SY

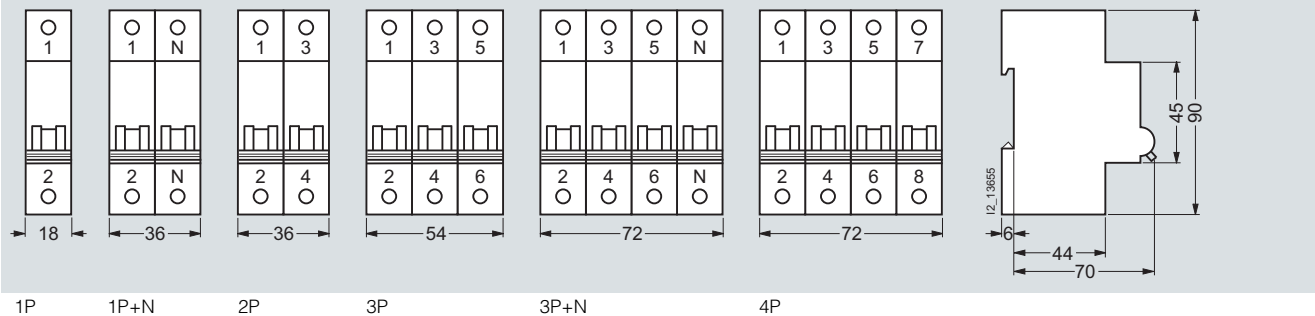

5SP

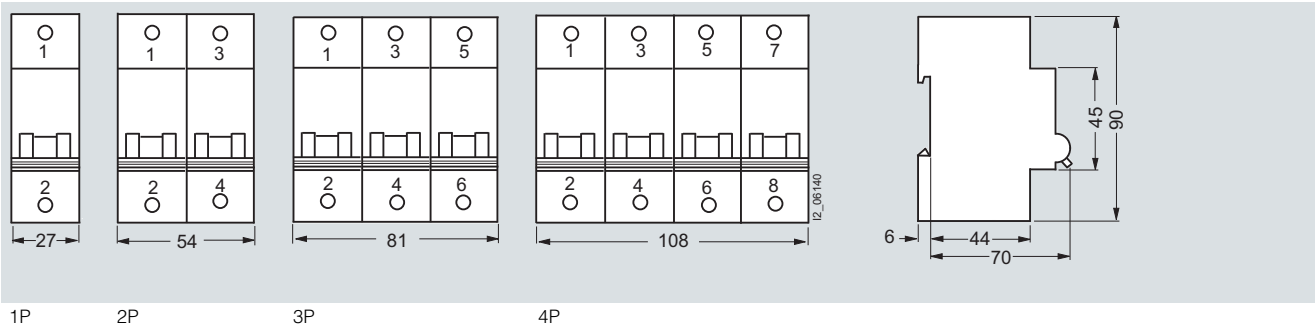

Schematics

Diagrams

5SY4, 5SY7, 5SY8



5SP4



5SY5, 5SP5



Miniature Circuit Breakers

5SJ6 miniature circuit breakers

Miniature circuit breakers
with plug-in terminals, 5SJ6 ...-KS

Overview

Miniature circuit breakers with plug-in terminals are used for the protection of socket outlets and lighting circuits with the most common rated currents of 10 to 20 A.

Technical specifications

		5SJ6 ...-KS	
Standards		EN 60898-1	
Approvals		http://www.siemens.com/lowvoltage/support	
Operational voltage		V AC	230/400
• Min.		V AC/DC	24
• Max.		V AC	250/440
• Max.		V	60 ¹⁾
		DC/pole	
Rated switching capacity	Acc. to EN 60898-1	kA AC	6
Insulation coordination		V AC	250/440
• Rated insulation voltage			2/III
• Pollution degree for overvoltage category			
Touch protection	Acc. to EN 50274		Yes
Handle end position, sealable			Yes
Degree of protection	Acc. to EN 60529		IP20, with connected conductors
CFC and silicone-free			Yes
Terminals		Screwless terminals on the outgoing terminals for 1.5 ... 4 mm ²	
Conductor cross-sections			
• Top, plug-in terminals			
- Solid, stranded and finely stranded, without end sleeve	mm ²		1.5 ... 4
- Finely stranded, with end sleeve	mm ²		1.5 ... 2.5
• Bottom, tunnel terminal			
- Solid, stranded or finely stranded, with end sleeve	mm ²		0.75 ... 25
Mounting position			Any
Service life, on average, with rated load			20000 actuations
Ambient temperature		°C	-25 ... +45, occasionally +55, max. 95 % humidity, storage temperature: -40 ... +75
Resistance to climate	Acc. to IEC 60068-2-30		6 cycles
Resistance to vibrations	Acc. to IEC 60068-2-6	m/s ²	50 at 25 ... 150 Hz and 60 at 35 Hz (4 sec)

¹⁾ The operational voltage 60 V DC/pole takes into account a battery charging voltage with a peak value of 72 V.

Dimensional drawings

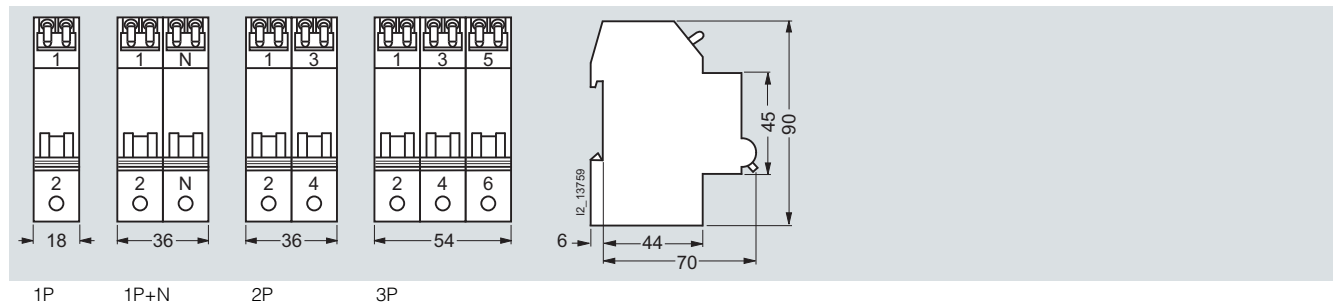

Schematics

Diagrams

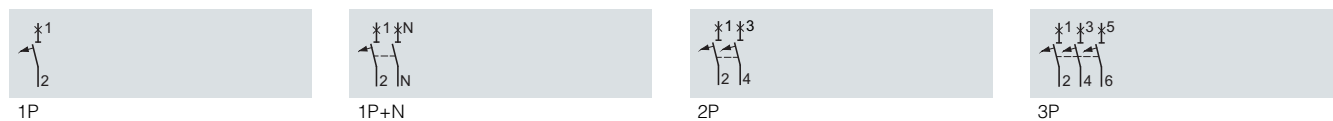

Miniature Circuit Breakers

Miniature circuit breakers 5SY6 0 1+N in 1 MW

Overview

These miniature circuit breakers are used for the protection of plants with switched neutral conductors in distribution boards with little space. They are just a single modular width.

Compact busbars facilitate installation in space saving distribution boards.

The devices are approved for worldwide use according to IEC standards for systems up to 250 V AC. 60 V DC per pole is permitted in DC systems according to IEC standards.

Technical specifications

		5SY6 0..
Standards		EN 60898-1
Approvals		http://www.siemens.com/lowvoltage/support
Rated voltage U_n	V AC	230
Operational voltage		
• Min.	V AC/DC	24
• Max.	V AC	250
• Max.	V DC/pole	60 ¹⁾
Rated switching capacity I_{cn}	kA AC	6
Insulation coordination		
• Rated insulation voltage	V AC	250
• Pollution degree for overvoltage category		2/III
Touch protection	Acc. to EN 50274	Yes
Handle end position , sealable		Yes
Degree of protection		IP20, with connected conductors
CFC and silicone-free		Yes
Terminals		
• Solid and stranded, top and bottom terminal	mm ²	0.75 ... 16
• Finely stranded, with end sleeve, top and bottom terminal	mm ²	0.75 ... 10
• Terminal tightening torque	Nm	2.0 ... 2.5
Mounting position		Any
Service life On average, with rated load		20000 actuations at 2 A/4 A and 40 A: 8000 actuations
Ambient temperature	°C	-25 ... +45, occasionally +55, max. 95 % humidity, storage temperature: -40 ... +75
Resistance to climate	Acc. to IEC 60068-2-30	6 cycles
Resistance to vibrations	Acc. to IEC 60068-2-6 m/s ²	50 at 25 ... 150 Hz and 60 at 35 Hz (4 sec)

¹⁾ The operational voltage 60 V DC/pole takes into account a battery charging voltage with a peak value of 72 V.



Miniature circuit breakers 5SY6 0 1+N in 1 MW

Dimensional drawings

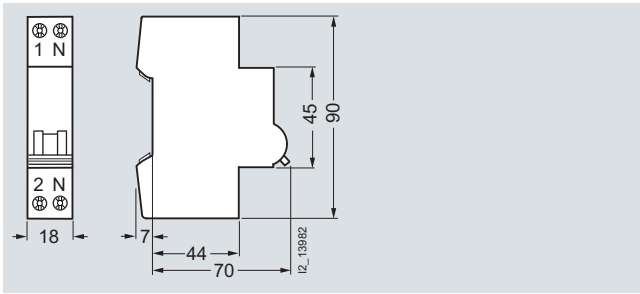

1P+N
N pole, right

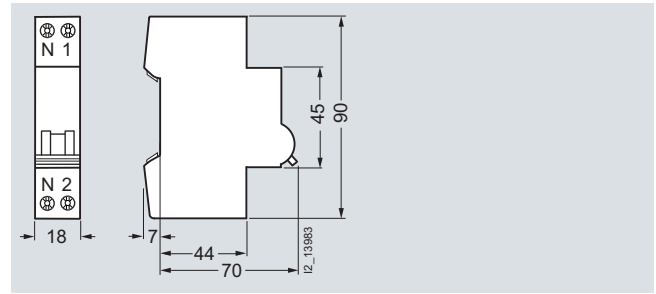

1P+N
N pole, left

5ST3 6 Pin spacing in MW

Dimensions of side view in mm (approx.).

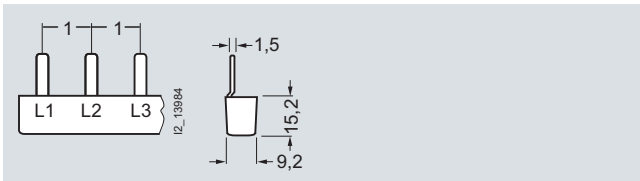

5ST3 613
5ST3 614
5ST3 615

5ST3 7 Pin spacing in MW

Dimensions of side view in mm (approx.).

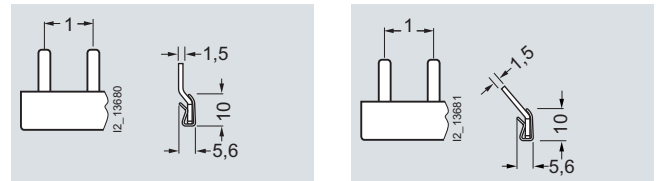

5ST3 762
5ST3 764

5ST3 763
5ST3 765

Schematics

Diagrams



1P+N
N pole, right



1P+N
N pole, left

Miniature Circuit Breakers

Additional components

Overview

The Siemens mounting concept supports the combination of all 5ST3 additional components with Siemens 5SY4 and 5SP4 miniature circuit breakers and with 5SU1 RCBOs.

5SL and 5SY6 0... miniature circuit breakers are suitable for mounting auxiliary switches and fault signal contacts. Auxiliary switches can also be mounted on 5TE8 flush-mounting circuit breakers and 5SG7 1 MINIZED switch disconnectors.

Auxiliary switches (AS)

The auxiliary switch (AS) always signals the contact position of the miniature circuit breaker, regardless of whether the miniature circuit breaker was tripped manually or as the result of a fault. An additional version is also available for the switching of small currents and voltages for the control of programmable control systems (PLCs) acc. to EN 61131-2. The auxiliary switch with test button enables the testing of control circuits without the need to switch the miniature circuit breaker.

Fault signal contacts (FC)

The fault signal contact (FC) signals the automatic tripping of the miniature circuit breaker in the event of a fault, such as an overload or a short circuit. If the fault signal contact is activated, the contact position does not change if the miniature circuit breaker is tripped manually. Fault signal contacts with TEST and RESET buttons enable the testing of control circuits without the need to trip the miniature circuit breaker. The red RESET button integrated in the handle also indicates the automatic tripping of the MCB. The signal can be acknowledged manually using the RESET button.

Shunt trips (ST)

Shunt trips are used for the remote tripping of miniature circuit breakers.

Undervoltage releases (UR)

Undervoltage releases are integrated (e.g. in EMERGENCY STOP loops), thus ensuring that the MCB trips in the event of an emergency, which, in turn, ensures disconnection of the control circuit according to EN 60204. In the event that the voltage is interrupted or too low, it also trips, i.e. prevents activation of the MCB.

Remote controlled mechanisms (RC)

Remote controlled mechanisms are used for the remote ON/OFF switching of miniature circuit breakers and the remote ON switching of RC units, as well as the local manual switching of these devices. A blocking function permits maintenance work. In the event that a miniature circuit breaker or RC unit is tripped, an acknowledgment must be carried out prior to switching back on. The remote controlled mechanism has an operating mode selector switch with the functions: "Locked", "Manual" and "Remote Switching". The mechanism can be mechanically latched and locked, which serves to protect personnel during maintenance work.

RC units

RC units can be combined with miniature circuit breakers of characteristic A, B, C and D. They then form a combination of RCCB and MCB for personnel, fire and line protection. The combinations can be tailored to meet individual requirements.

For information on RC units, please refer to the section "Residual Current Protective Devices".

Technical specifications

	Auxiliary switches (AS)		Fault signal contacts (FC)
	5ST3 010, 5ST3 010-2 5ST3 011, 5ST3 011-2 5ST3 012, 5ST3 012-2	5ST3 013 5ST3 014 5ST3 015	5ST3 020, 5ST3 020-2 5ST3 021, 5ST3 021-2 5ST3 022, 5ST3 022-2
Standards	EN 62019; IEC/EN 60947-5-1; UL 1077; CSA C22.2 No. 235		
Approvals	http://www.siemens.com/lowvoltage/support		
Short-circuit protection	Miniature circuit breaker or gG 6 A fuse		
Contact load			
• Min.	50 mA, 24 V	1 mA/5 V DC	50 mA, 24 V
• Max.	--	50 mA/30 V DC	--
• 400 V AC, AC-14, NO	A 2	--	2
• 230 V AC, AC-14, NO	A 6	--	6
• 400 V AC, AC-13, NC	A 2	--	2
• 230 V AC, AC-13, NC	A 6	--	6
• 220 V DC, DC-13, NO+NC	A 1	--	1
• 110 V DC, DC-13, NO+NC	A 1	--	1
• 60 V DC, DC-13, NO+NC	A 3	--	3
• 24 V DC, DC-13, NO+NC	A 6	--	6
Service life, on average, with rated load	20000 actuations	20000 actuations	20000 actuations
Conductor cross-sections	mm ² AWG	0.5 ... 2.5 22 ... 14	0.5 ... 2.5 22 ... 14
Terminals			
• Terminal tightening torque	Nm lb/in	0.5 4.5	0.5 4.5

		Undervoltage releases (UR)	Shunt trips (ST)		Remote controlled mechanisms (RC)
		5ST3 04.	5ST3 030	5ST3 031	5ST3 050
Standards		EN 60947-1			
Rated voltages U_n	V AC	230	110 ... 415	24 ... 60	230
	V DC	24, 110	110	24 ... 60	--
	Hz	--	50 ... 60	--	50 ... 60
• Rated frequency f_n					
Response limits					
• Acc. to EN 60947-1, 7.2.1.3					
- Releases		$< 0.35 \dots 0.7 \times U_n$	--	--	--
- Permissible fluctuations of the power supply		$0.85 \dots 1.1 \times U_n$	--	--	--
• Acc. to EN 60947-1, 7.2.1.4		--	$0.7 \dots 1.1 \times U_n$	--	--
Short-circuit protection		Miniature circuit breaker or gG 6 A fuse			
Minimum contact load		50 mA, 24 V	50 mA, 24 V	--	--
Tripping operations		max. 2000	max. 2000	--	--
Service life, on average, with rated load		20000 actuations	20000 actuations	20000 actuations	20000 actuations
Conductor cross-sections	mm ²	0.5 ... 2.5	0.5 ... 2.5	0.5 ... 2.5	0.5 ... 2.5
	AWG	22 ... 14	22 ... 14	22 ... 14	22 ... 14
Terminals					
• Terminal tightening torque	Nm	0.8	0.8	0.8	0.5
	lb/in	6.8	6.8	6.8	4.5

For technical data on the RC units, please refer to the chapter "Residual Current Protective Devices".

Dimensional drawings

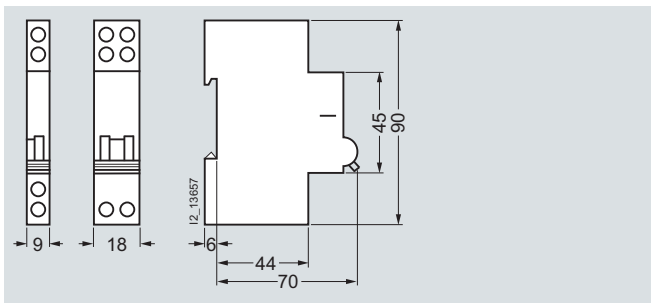

5ST3 010 5ST3 030
 5ST3 011 5ST3 031
 5ST3 012 5ST3 040
 5ST3 013 5ST3 041
 5ST3 014 5ST3 042
 5ST3 015 5ST3 043
 5ST3 020 5ST3 044
 5ST3 021 5ST3 045
 5ST3 022

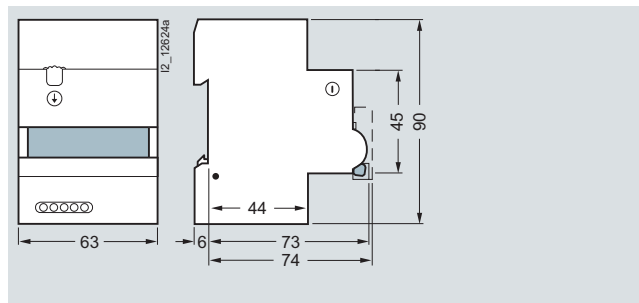

5ST3 050

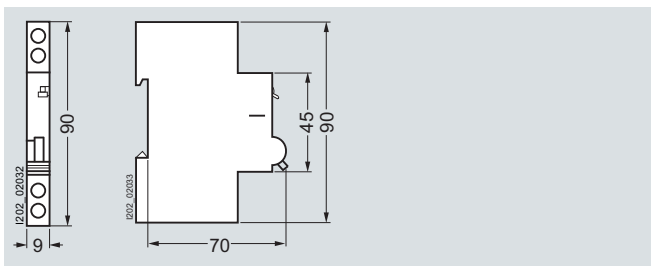

5ST3 010-2
 5ST3 011-2
 5ST3 012-2

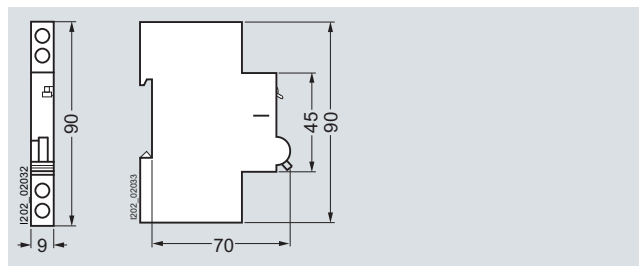

5ST3 020-2
 5ST3 021-2
 5ST3 022-2

Miniature Circuit Breakers

Additional components

Schematics

Diagrams

Auxiliary switches (AS)

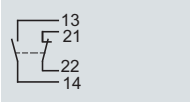

5ST3 010
5ST3 013
5ST3 010-2

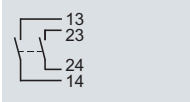

5ST3 011
5ST3 014
5ST3 011-2

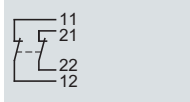

5ST3 012
5ST3 015
5ST3 012-2

Fault signal contacts (FC)

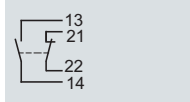

5ST3 020
5ST3 020-2

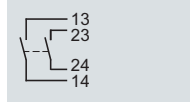

5ST3 021
5ST3 021-2

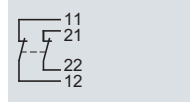

5ST3 022
5ST3 022-2

Shunt trips (ST)

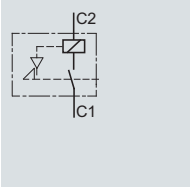

5ST3 030
5ST3 031

Undervoltage releases (UR)

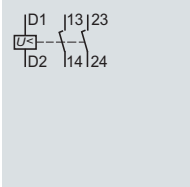

5ST3 040
5ST3 041
5ST3 042

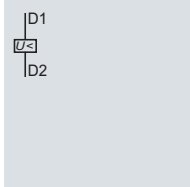

5ST3 043
5ST3 044
5ST3 045

Remote controlled mechanisms (RC)

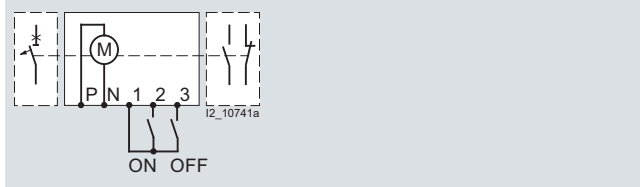

5ST3 050

More information

The Siemens mounting concept supports the combination of all 5ST3 additional components with miniature circuit breakers of the 5SY and 5SP series and RCBOs of the 5SU1 series.

5SL and 5SY6 0.. miniature circuit breakers are suitable for mounting auxiliary switches and fault signal contacts. Auxiliary switches can also be mounted on 5TE8 flush-mounting circuit breakers and 5SG7 1 MINIZED switch disconnectors.

The chart shows which additional components can be mounted on either the right or the left.

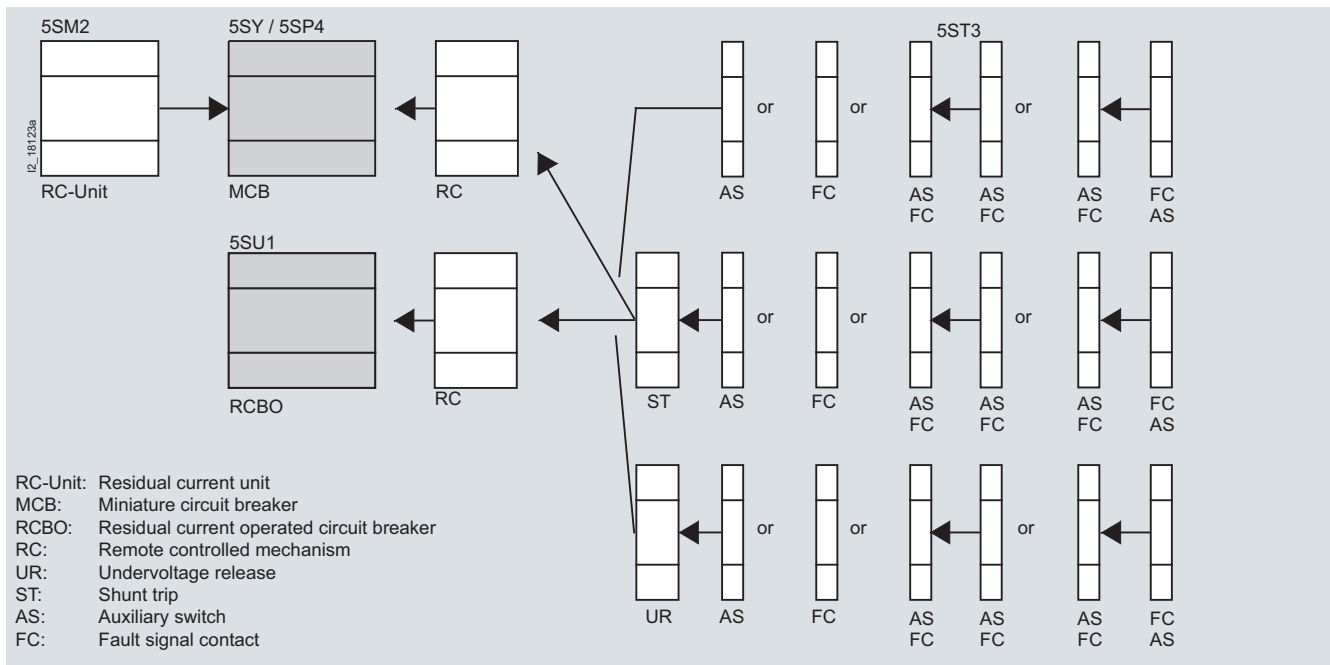

For further information on the mounting concept for RCBOs, please refer to the chapter, "Residual Current Protective Devices".

Overview

The busbar system with pin-type connections can be used for all 5SL6 and 5SJ6 miniature circuit breakers . . . -KS and 5SY miniature circuit breakers with or without mounted auxiliary switch (AS) or fault signal contact (FC).

Busbars in 10 mm² and 16 mm² versions are available.

The 5ST3 7 busbar system with bars that can be cut to length can be tailored to any requirements.

The extremely flexible 5ST3 6 busbar system with fixed lengths also enables installation in any length as the busbars can be overlapped.

No further need for time-consuming tasks, such as cutting, cutting to length, deburring, cleaning of cut surfaces and mounting of end caps.

Any free pins on the busbars can be made safe by covering with touch protection.

For further information on bus-mounting miniature circuit breakers with residual current operated circuit breakers, please refer to the chapter "Residual Current Protective Devices".

Technical specifications

		5ST3
Standards		EN 60439-1 (VDE 0660-500): 2005-01
Busbar material		SF-Cu F 24
Partition material		Plastic, Cycloy 3600 heat-resistant over 90 °C flame-retardant and self-extinguishing, dioxin and halogen-free
Rated operational voltage U_c	V AC	400
Rated current I_n		
• Cross-section 10 mm ²	A	63
• Cross-section 16 mm ²	A	80
Rated impulse withstand voltage U_{imp}	kV	4
Test pulse voltage (1.2/50)	kV	6.2
Rated conditional short-circuit current I_{cc}	kA	25
Resistance to climate		
• Constant atmosphere	Acc. to DIN 50015	23/83; 40/92; 55/20
• Humid heat	Acc. to IEC 60068-2-30	28 cycles
Insulation coordination		
• Overvoltage category		III
• Pollution degree		2
Maximum busbar current I_S/phase		
• Infeed at the start of the busbar		
- Cross-section 10 mm ²	A	63
- Cross-section 16 mm ²	A	80
• Infeed at the center of the busbar		
- Cross-section 10 mm ²	A	100
- Cross-section 16 mm ²	A	130

Infeed at the start or end of the busbar



Infeed along the busbar or midpoint infeed

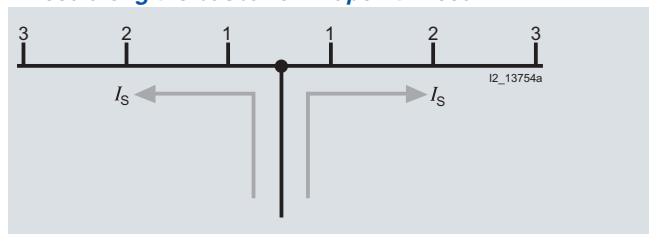

The sum of the output current per branch (1, 2, 3 ... n) must not be greater than the max. busbar current I_S /phase.

Miniature Circuit Breakers

Busbars

Standard 5ST3 6, 5ST3 7

Dimensional drawings

5ST3 6

Pin spacings in MW (modular width 1 MW = 18 mm)

Dimensions of side view in mm (approx.)

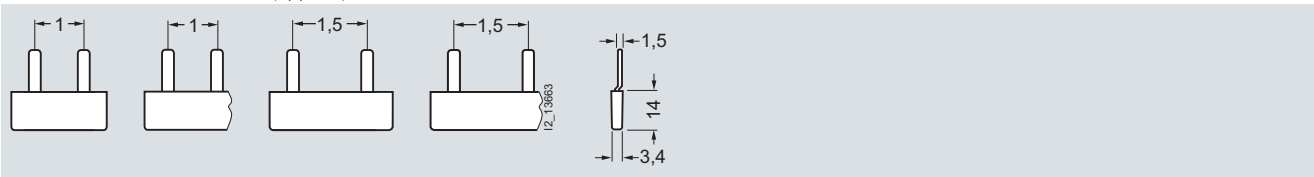

- | | | | |
|----------|----------|----------|----------|
| 5ST3 600 | 5ST3 601 | 5ST3 603 | 5ST3 604 |
| 5ST3 630 | 5ST3 602 | 5ST3 633 | 5ST3 605 |
| | 5ST3 631 | | 5ST3 634 |
| | 5ST3 632 | | 5ST3 635 |

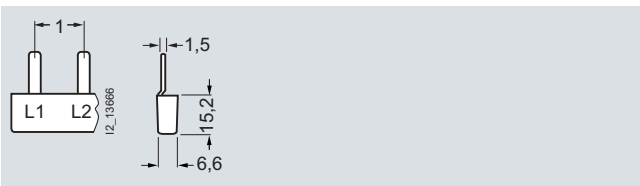

- 5ST3 606
5ST3 607
5ST3 608

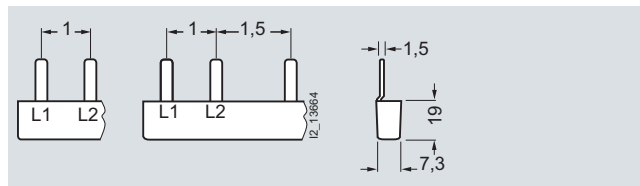

- | | |
|----------|----------|
| 5ST3 636 | 5ST3 640 |
| 5ST3 637 | 5ST3 641 |
| 5ST3 638 | 5ST3 642 |

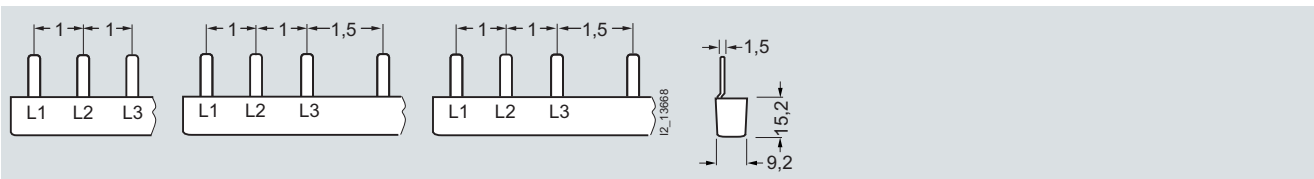

- | | | |
|----------|----------|----------|
| 5ST3 613 | 5ST3 616 | 5ST3 618 |
| 5ST3 614 | 5ST3 617 | 5ST3 620 |
| 5ST3 615 | | |
| 5ST3 667 | | |

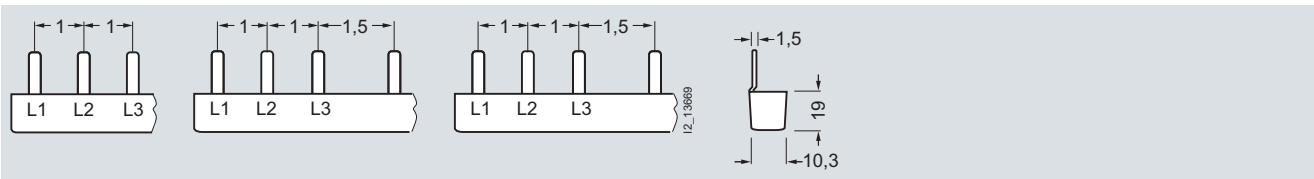

- | | | |
|----------|----------|----------|
| 5ST3 643 | 5ST3 646 | 5ST3 648 |
| 5ST3 644 | 5ST3 647 | 5ST3 650 |
| 5ST3 645 | | |
| 5ST3 668 | | |

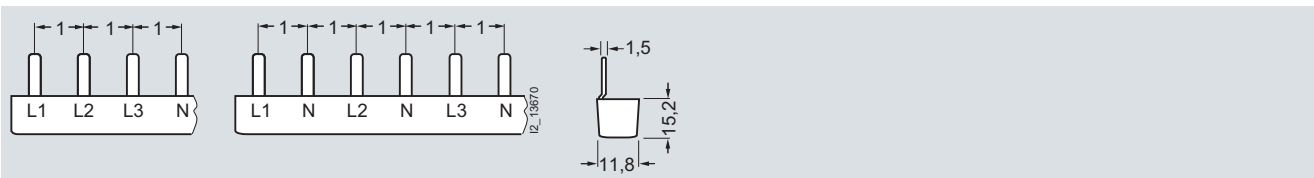

- | | |
|----------|----------|
| 5ST3 621 | 5ST3 623 |
| 5ST3 622 | |

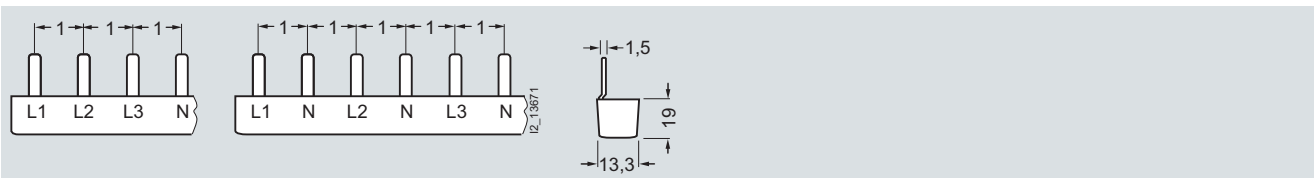

- | | |
|----------|----------|
| 5ST3 651 | 5ST3 653 |
| 5ST3 652 | |

Miniature Circuit Breakers Busbars

Standard 5ST3 6, 5ST3 7

5ST3 6 Pin spacings in MW (modular width 1 MW = 18 mm)

Dimensions of side view in mm (approx.)

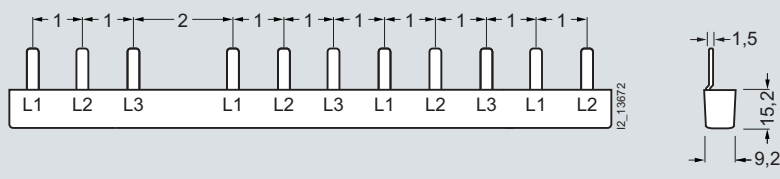

5ST3 624

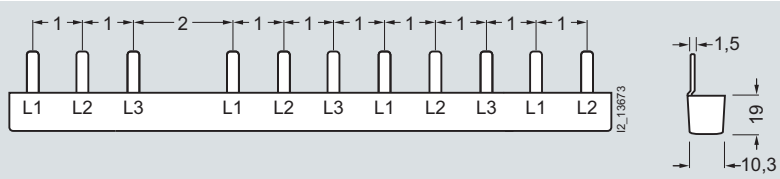

5ST3 654

5ST3 7 Pin spacings in MW (modular width 1 MW = 18 mm)

Dimensions of side view in mm (approx.)

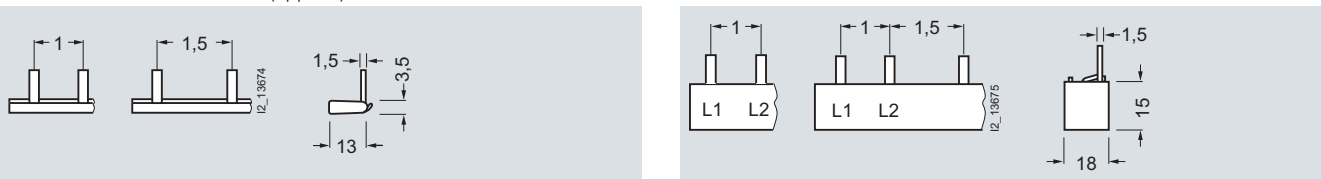

5ST3 700 5ST3 702
5ST3 701 5ST3 703
5ST3 730 5ST3 732
5ST3 731 5ST3 733
Single-phase Single-phase

5ST3 704 5ST3 706
5ST3 705 5ST3 707
5ST3 734 5ST3 736
5ST3 735 5ST3 737
2-phase 2-phase

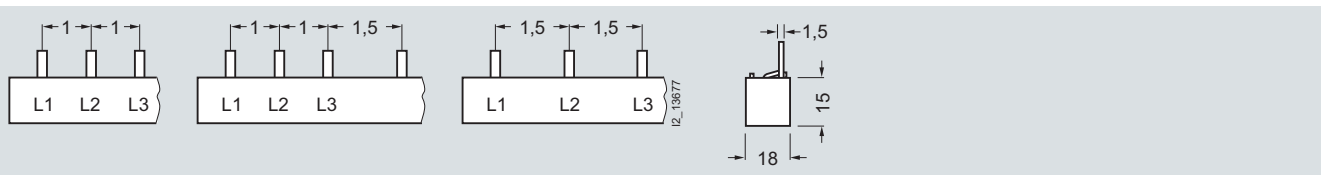

5ST3 708 5ST3 711 5ST3 713
5ST3 710 5ST3 712 5ST3 714
5ST3 738 5ST3 741 5ST3 743
5ST3 740 5ST3 742 5ST3 744

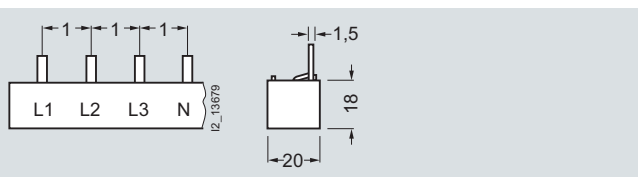

5ST3 715
5ST3 716
5ST3 745
5ST3 746

Miniature Circuit Breakers

Busbars

Standard 5ST3 6, 5ST3 7

5ST3 7 Pin spacings in MW (modular width 1 MW = 18 mm)

Dimensions of side view in mm (approx.)

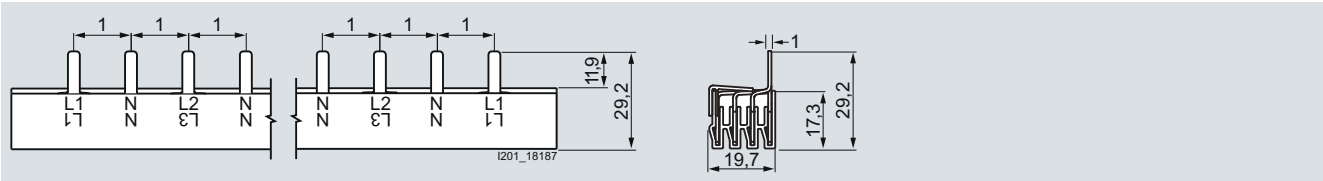

5ST3 770-2

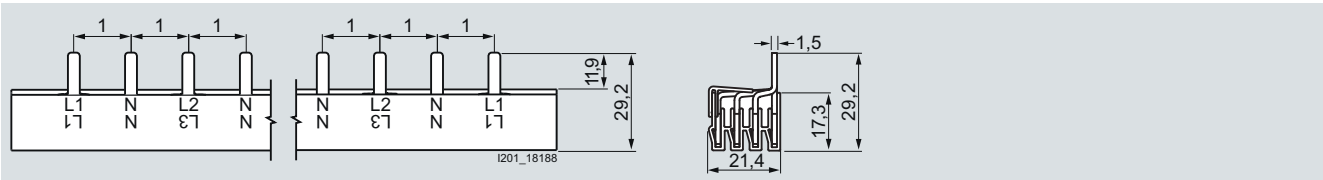

5ST3 770-3

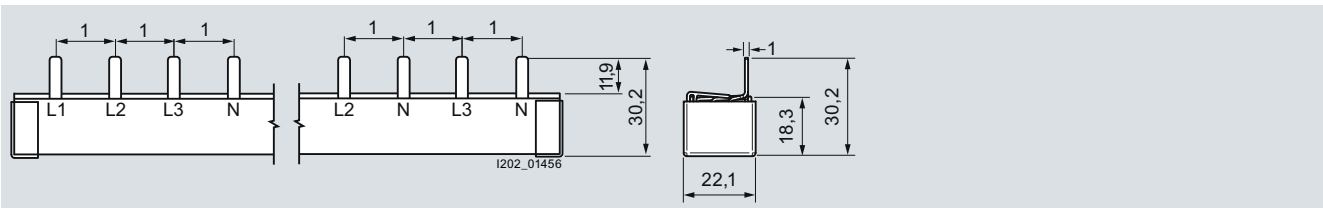

5ST3 770-4

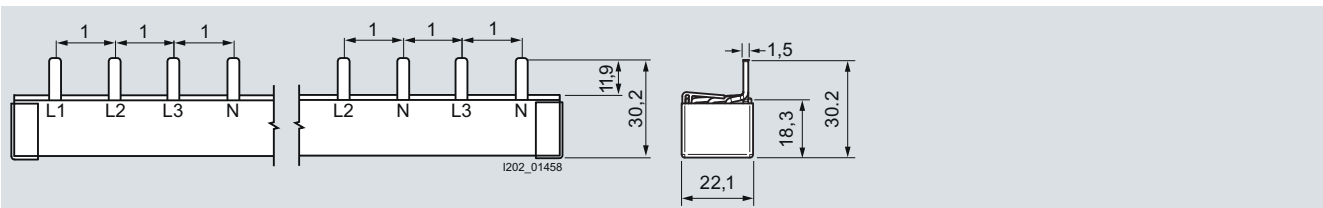

5ST3 770-5

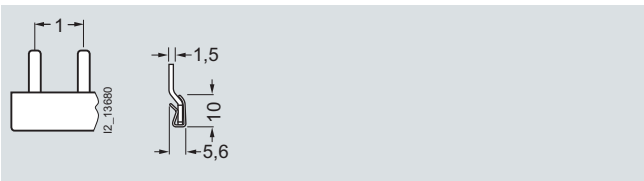

5ST3 762
5ST3 764

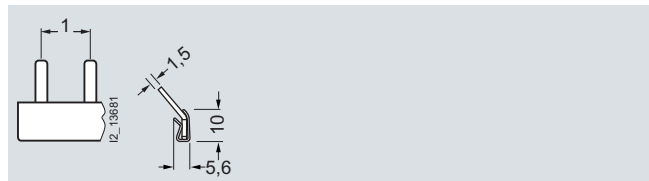

5ST3 763
5ST3 765

Overview

Products according to UL standards are used in North America, but also in several other countries. This is important in particular for exporting machines or electrical switchgear and equipment to the USA. Acceptance and delivery are possible only if the relevant UL standards are satisfied.

The 5ST3 7 busbar system according to UL 508 and CSA is suitable for both universal use worldwide with all 5SY and 5SP miniature circuit breakers for Supplementary Protection certified according to UL 1077 and for 3NW and 3NC fuse holders certified according to UL 512.

The busbars are available in single-, two- and three-phase version with different pin spacings and with two cross-sections 18 mm² and 25 mm². Infeed can be directly into the terminals of the miniature circuit breaker or through connection terminals.

The connection terminals are available in two versions – for direct infeed at the busbar or for infeed directly at the miniature circuit breaker/fuse holder. Pins that are not required can be covered with touch protection covers.

Technical specifications

		5ST3 7..-0HG	5ST3 7..-2HG	5ST3 770-0HG	5ST3 770-1HG
Standards		UL 508, CSA C22.2 No. 14-M 95			
Approvals		UL 508 File No. E328403 CSA			
Operational voltage					
• Acc. to IEC	V AC	690			
• Acc. to UL 508	V AC	600			
Rated conditional short-circuit current	kA	10			
• Dielectric strength	kV/mm	25			
• Surge strength	kV	> 9.5			
Rated current	A	--	--	115	
Maximum busbar current I_S/phase					
• Infeed at the start of the busbar	A	80	100	--	--
• Infeed at the center of the busbar	A	160	200	--	--
Insulation coordination					
• Overvoltage category		III			
• Pollution degree		2			
Busbar cross-section	mm ² Cu	18	25	--	--
Infeed		Any			
Conductor cross-sections	AWG	--	--	10 ... 1/0	14 ... 1
	mm ²	--	--	6 ... 35	6 ... 50
Terminals					
• Terminal tightening torque	Nm	--	--	5	3.5
	lbs/in	--	--	50	35

Infeed at the start or end of the busbar

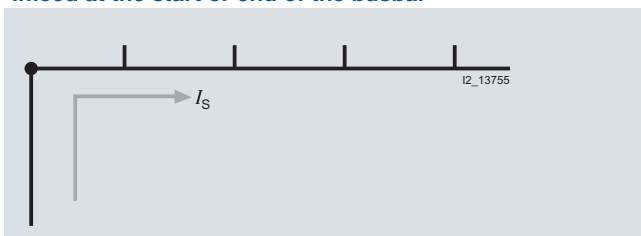

Infeed along the busbar or midpoint infeed

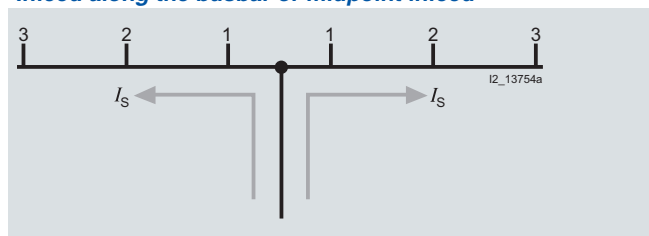

The sum of the output current per branch (1, 2, 3 ... n) must not be greater than the max. busbar current I_S /phase.

Miniature Circuit Breakers

Busbars

Acc. to UL 508, 5ST3 7 . . . HG

Dimensional drawings

5ST3 7 busbars

Pin spacings in MW (modular width 1 MW = 18 mm)

Dimensions of side view in mm (approx.)

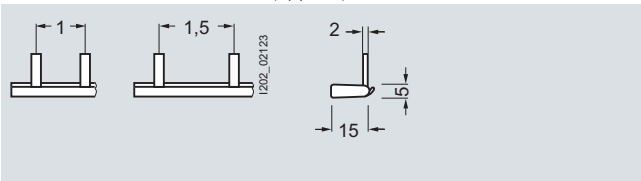

5ST3 701-0HG 5ST3 703-0HG

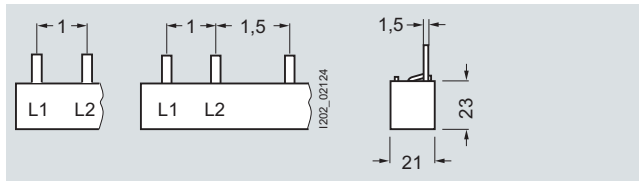

5ST3 705-0HG 5ST3 707-0HG

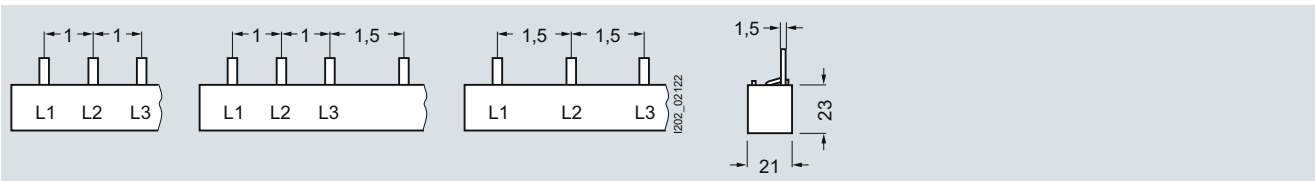

5ST3 710-0HG 5ST3 712-0HG 5ST3 714-0HG

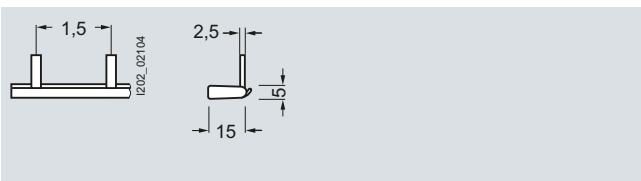

5ST3 701-2HG

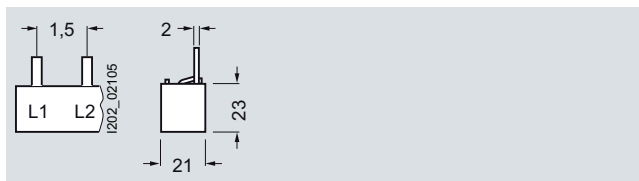

5ST3 705-2HG

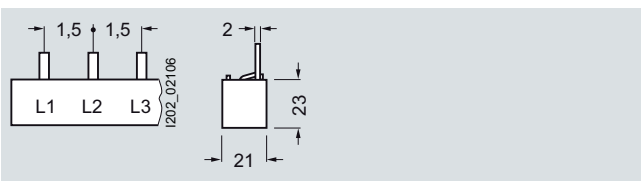

5ST3 710-2HG

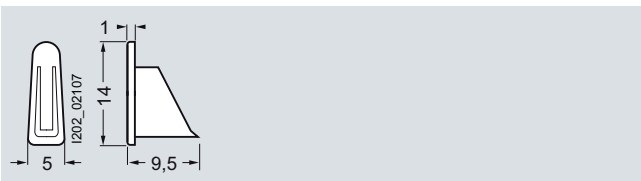

5ST3 748-0HG

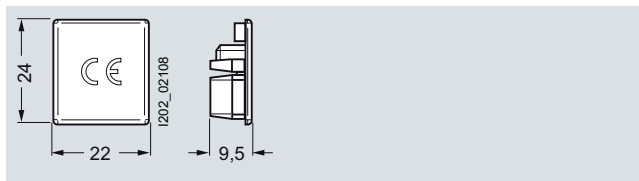

5ST3 750-0HG

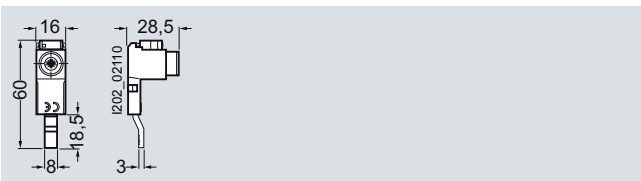

5ST3 770-0HG

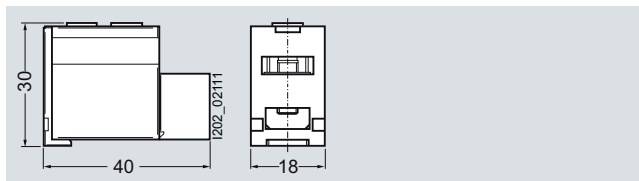

5ST3 770-1HG

5ST3 6 touch protection covers

Pin spacings in MW (modular width 1 MW = 18 mm)

Dimensions of side view in mm (approx.)

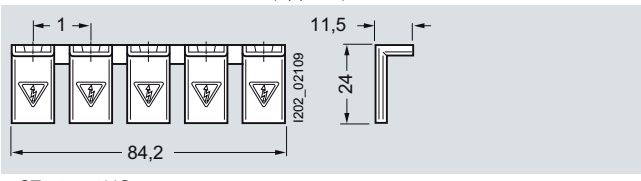

5ST3 655-0HG

Overview

Switching capacity

Particular demands are made on miniature circuit breakers with regard to switching capacity.

The values are standardized and are determined according to the test conditions of IEC/EN 60898-1/-2 or DIN VDE 0641-11.

The values of the rated switching capacity are and .

For other test conditions, it is also possible to specify values higher than those stipulated in IEC/EN 60898-1/-2 or DIN VDE 0641-11.

One such standard is IEC/EN 60947-2 or DIN VDE 0660-101 for circuit breakers.

Rated switching capacity

5SL6, 5SY4, 5SY7, 5SY8, 5SY6 0 and 5SP4 miniature circuit breakers

	I_n [A]	IEC/EN 60898-1		IEC/EN 60947-2	
		1-pole 230 V AC I_{cn} [kA]	2-, 3- and 4-pole 400 V AC I_{cn} [kA]	1-pole 230 V AC I_{cu} [kA]	2-, 3- and 4-pole 400 V AC I_{cu} [kA]
5SL6	0.3 ... 6	6		--	
	8 ... 32	6		--	
	40 ... 63	6		--	
5SY4	0.3 ... 6	10		35	
	8 ... 32	10		20	
	40 ... 63	10		15	
	80	10		10	
5SY7	0.3 ... 2	15		50	
	3 ... 6	15		40	
	8 ... 10	15		30	
	13 ... 32	15		25	
	40 ... 63	15		20 ¹⁾	
5SY8	0.3 ... 2	--		70	
	3 ... 6	--		50	
	8 ... 10	--		40	
	13 ... 32	--		30	
	40 ... 63	--		25 ²⁾	
5SY6 0..	2 ... 40	6	--	6	--
5SP4	80 ... 125	10		20 ³⁾	

1) D50 and D63: I_{cu} = 15 kA.

2) D50 and D63: I_{cu} = 20 kA.

3) D80 and D100: I_{cu} = 15 kA.

5SP5 and 5SY5 miniature circuit breakers

Miniature circuit breakers, universal current	I_n [A]	IEC/EN 60898-2		IEC/EN 60898-2	
		1-pole 230/400 V AC I_{cn} [kA]	2-pole 400 V AC I_{cn} [kA]	1-pole 220 V DC I_{cn} [kA]	2-pole 440 V DC I_{cn} [kA]
5SY5	0.3 ... 63	10		15	
5SP5	80 ... 125	3		10	

Miniature Circuit Breakers

Configuration and dimensioning

Characteristic curves

Tripping characteristics acc. to IEC/EN 60898-1, DIN VDE 0641-11

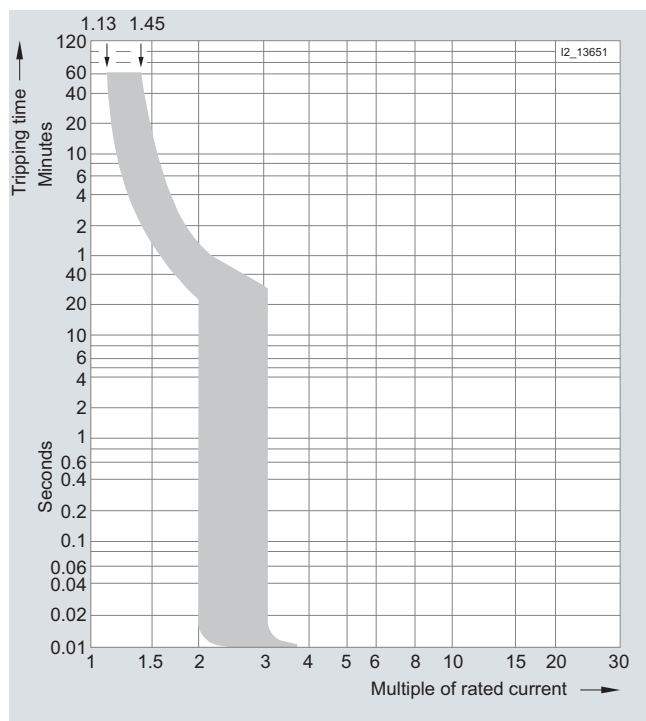

Tripping characteristic A

For limited semiconductor protection, protection of measuring circuits with transformers. Protection of circuits with tripping in 0.4 s acc. to DIN VDE 0100-410, for long cable lengths.

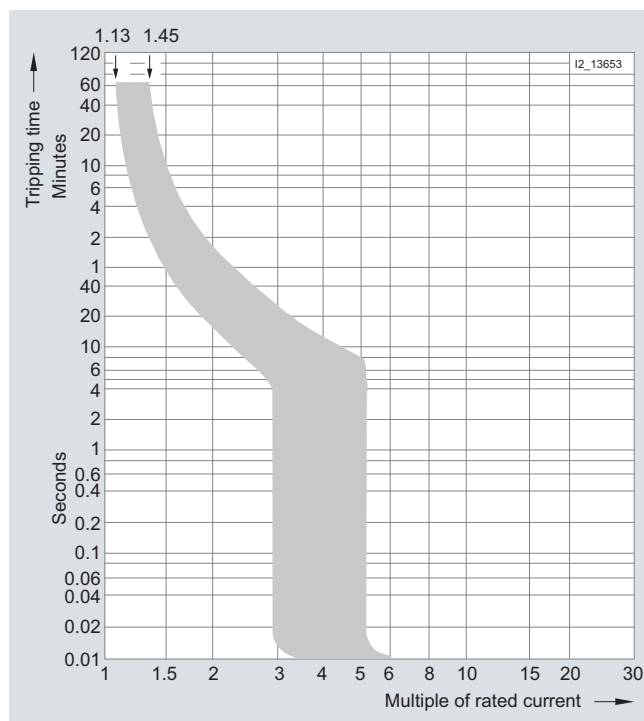

Tripping characteristic B

MCBs with this tripping characteristic are designed for universal use in socket outlet and lighting circuits. Proof of personal safety acc. to DIN VDE 0100-410 is not required.

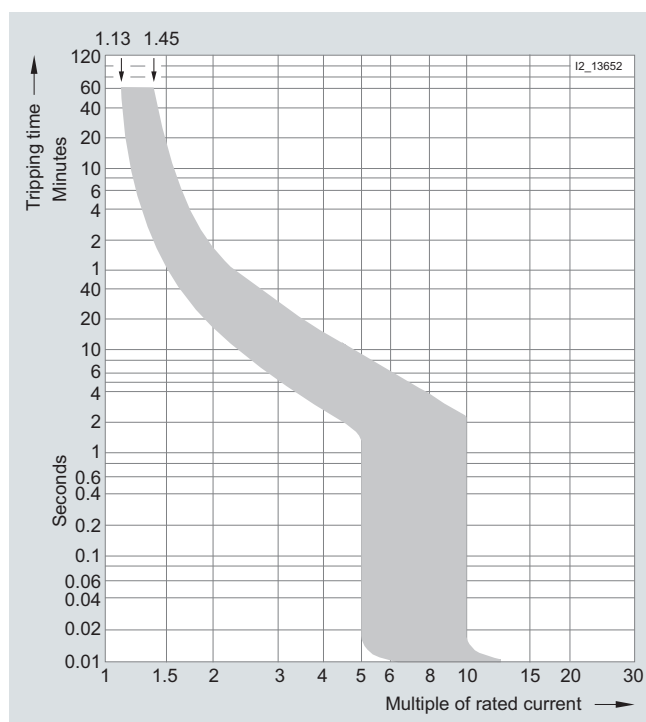

Tripping characteristic C

In lamp and motor circuits with higher starting currents, MCBs with tripping characteristic C are generally used.

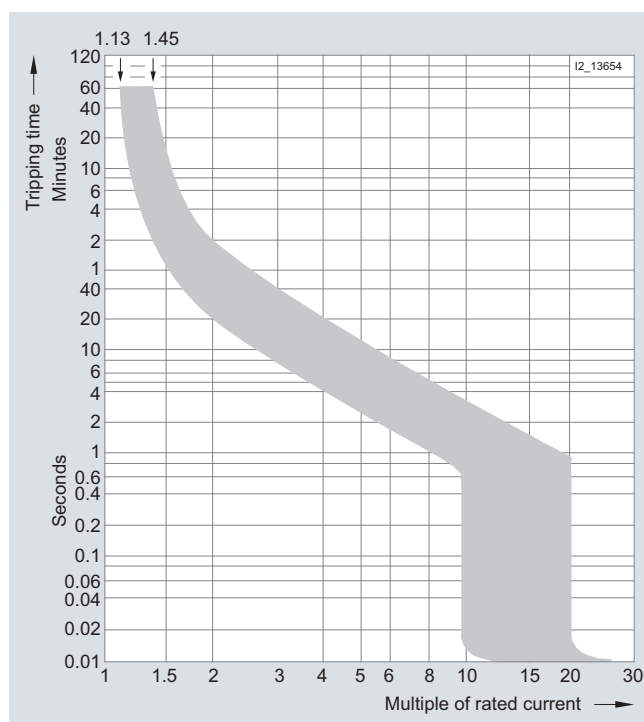

Tripping characteristic D

For electrical circuits with strong pulse-generating equipment, such as transformers or solenoid valves.

Configuration and dimensioning

Tripping characteristics

Tripping characteristics at ambient temperature 30 °C

Tripping characteristic	Standards	Thermal trips				Electromagnetic trips			
		Test currents:	Limiting Test current I_1	Minimum Test current I_2	Tripping time $I_n \leq 63$ A t	$I_n > 63$ A t	Hold I_4	Latest tripping instant I_5	Tripping time t
A	--		$1.13 \times I_n$	$1.45 \times I_n$	> 1 h < 1 h	> 2 h < 2 h	$2 \times I_n$	$3 \times I_n$	≥ 0.1 s < 0.1 s
B	IEC/EN 60898-1, DIN VDE 0641-11		$1.13 \times I_n$	$1.45 \times I_n$	> 1 h < 1 h	> 2 h < 2 h	$3 \times I_n$	$5 \times I_n$	≥ 0.1 s < 0.1 s
C	IEC/EN 60898-1, DIN VDE 0641-11		$1.13 \times I_n$	$1.45 \times I_n$	> 1 h < 1 h	> 2 h < 2 h	$5 \times I_n$	$10 \times I_n$	≥ 0.1 s < 0.1 s
D	IEC/EN 60898-1, DIN VDE 0641-11		$1.13 \times I_n$	$1.45 \times I_n$	> 1 h < 1 h	> 2 h < 2 h	$10 \times I_n$	$20 \times I_n$ (IEC 60898: $50 \times I_n$)	≥ 0.1 s < 0.1 s

Correction factors for the rated current at different ambient temperatures for 5SY

Dependence of the permissible continuous load current on the ambient temperature for 5SY miniature circuit breakers

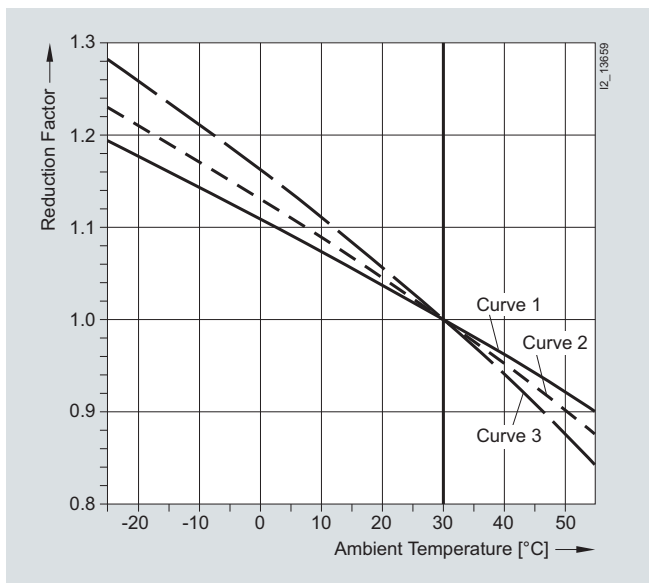

The valid curve for the correction factor can be found in the following table.

Curve for correction factor for 5SY miniature circuit breakers (for curves, see top left-hand diagram)

Rated current (A)	0.3	0.5	1	1.6	2	3	4	6	8	10	13	16	20	25	32	40	50	63	80
Characteristic	Valid curves for the correction factor for 5SY miniature circuit breakers																		
A	3	3	2	2	2	3	3	3	2	3	2	2	3	2	2	3	2	3	--
1P/2P	3	3	2	2	2	3	3	3	2	3	2	2	3	2	2	3	2	3	--
3P/4P	2	2	2	1	2	2	2	2	2	2	1	1	2	1	1	1	1	2	--
B	--	--	--	--	--	--	--	3	--	3	2	2	3	3	2	3	2	3	2
1P/2P	--	--	--	--	--	--	--	3	--	3	2	2	3	3	2	3	2	3	2
3P/4P	--	--	--	--	--	--	--	2	--	2	1	2	2	1	1	1	1	1	1
C	3	3	2	2	2	3	3	3	3	3	2	3	3	2	2	3	2	3	2
1P/2P	3	3	2	2	2	3	3	3	3	3	2	3	3	2	2	3	2	3	2
3P/4P	2	2	2	1	2	2	2	2	3	3	2	2	2	2	2	2	1	2	1
D	3	3	2	2	2	3	3	3	3	3	2	3	3	2	2	3	2	3	--
1P/2P	3	3	2	2	2	3	3	3	3	3	2	3	3	2	2	3	2	3	--
3P/4P	2	2	2	1	2	2	2	2	3	3	2	2	2	2	2	2	1	2	--

Curve for correction factor for 5SY6 0.. miniature circuit breakers (for curves, see top right-hand diagram)

Rated current (A)	2	4	6	8	10	13	16	20	25	32	40
Characteristic	Valid curves for correction factor for 5SY6 0.. miniature circuit breakers										
B	--	--	1	--	2	2	2	2	1	2	2
C	--	--	1	3	2	2	3	3	1	2	2

Miniature Circuit Breakers

Configuration and dimensioning

Correction factors for rated current if bundling

If more than one electrical circuit is loaded in a series of miniature circuit breakers, the resulting increase in ambient temperature affects the characteristic curve. In this case, you need to include an additional correction factor, which is specific to the rated current of the MCB(s).

Number of MCBs	1	2 ... 3	4 ... 6	> 7
Correction factor K	1.00	0.90	0.88	0.85

Correction factors for rated current at different frequencies

The tripping characteristic applies to a frequency of 50 Hz to 60 Hz. In the case of other frequencies, the following correction factors must be taken into account.

In the overrange, the limits of the characteristic curves correspond to the correction factors of the thermal tripping operation. In the event of a short-circuit, the limits of the characteristic curves correspond to the correction factors of the magnetic tripping operation.

Thermal tripping operation

	Rated current I_n (A)	Correction factor for					
		0 Hz	16 2/3 Hz	50 Hz	125 Hz	400 Hz	1000 Hz
5SY	0.3 ... 10	1	1	1	1	0.99	0.97
	1 ... 40	1	1	1	0.98	0.97	0.93
	50 ... 63	1	1	1	0.98	0.94	0.86
5SP	80 ... 125	1	1	1	0.97	0.92	0.85

Magnetic tripping operation

	Rated current I_n (A)	Correction factor for					
		0 Hz	16 2/3 Hz	50 Hz	125 Hz	400 Hz	1000 Hz
5SY	0.3 ... 63	1.4	1	1	1.2	1.4	1.7
5SP	80 ... 125	1.5	1	1	1.05	1.3	1.8

Dependence of the reduction factor on the ambient temperature for 5SP miniature circuit breakers

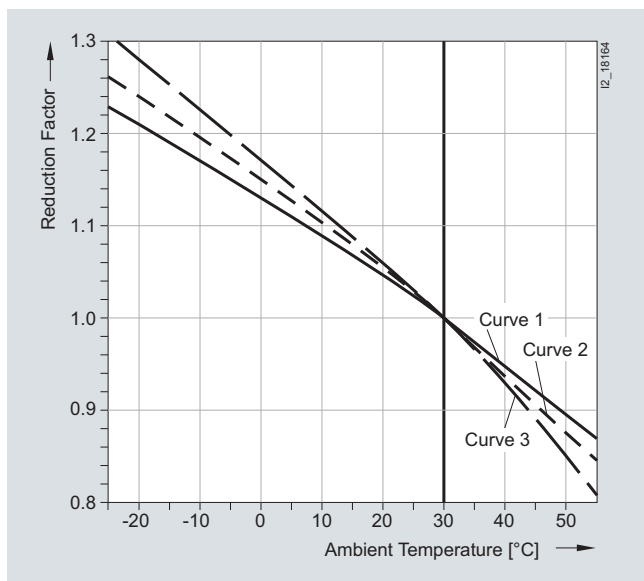

Legend for curves on the left-hand side of the diagram for 5SP miniature circuit breakers:

- Curve 1: 5SP, multipole, 80 A/100 A, characteristics B/C/D, 5SP, multipole, 125 A, characteristic B/C
- Curve 2: 5SP, 1-pole, 80 A, characteristics B/C/D
- Curve 3: 5SP, 1-pole, 100 A, characteristics B/C/D, 5SP, 1-pole, 125 A, characteristics B/C

Configuration and dimensioning

Let-through I^2t values 5SL6 (AC)

Characteristic B

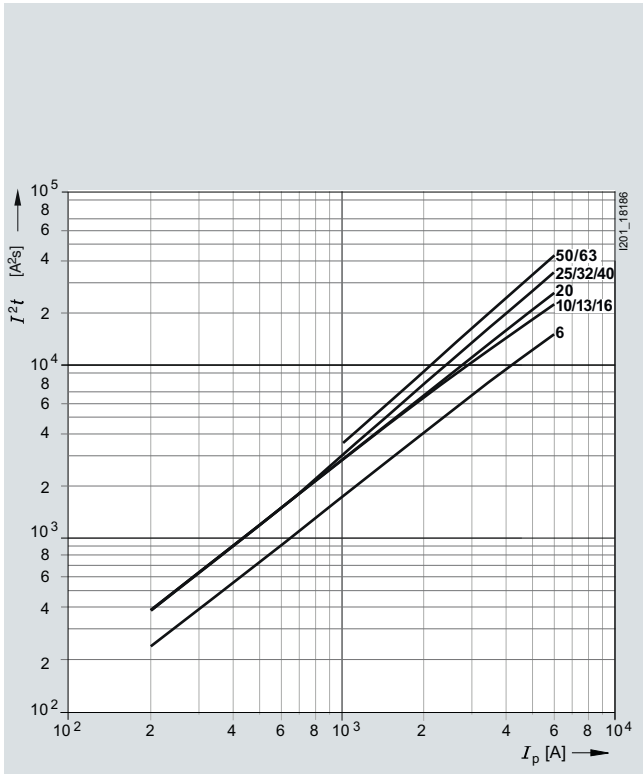

Characteristic C

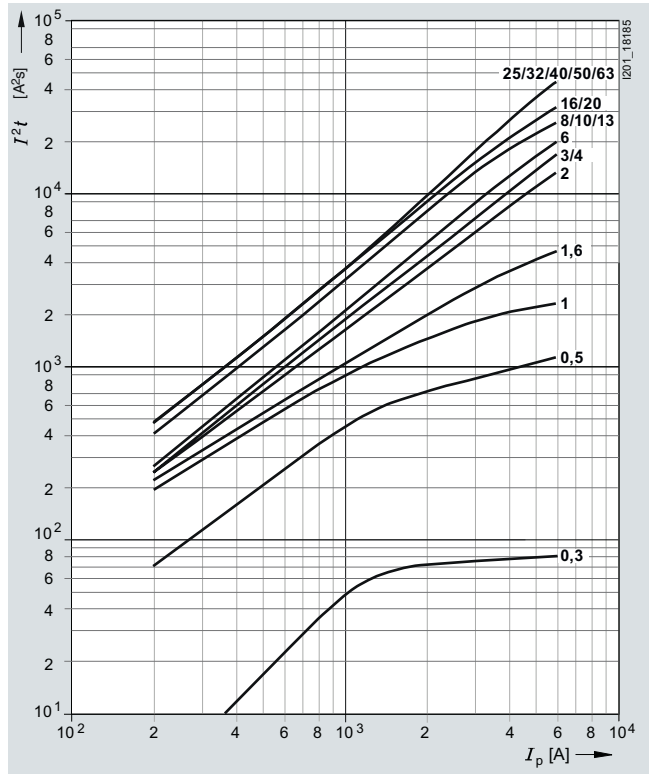

Miniature Circuit Breakers

Configuration and dimensioning

Let-through I^2t values 5SY4 (AC)

Characteristic A

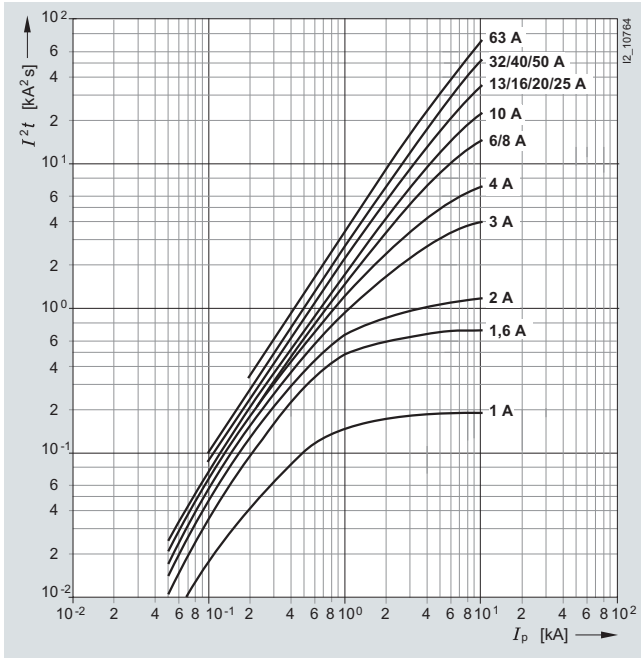

Characteristic C

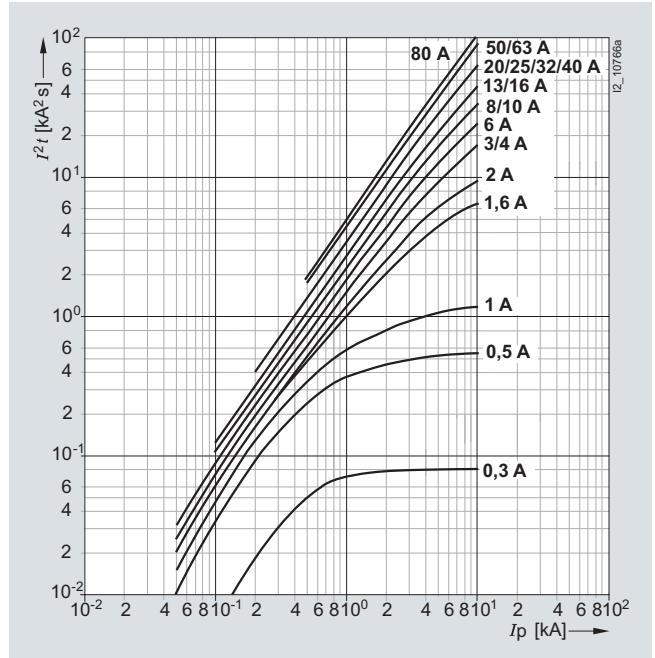

Characteristic B

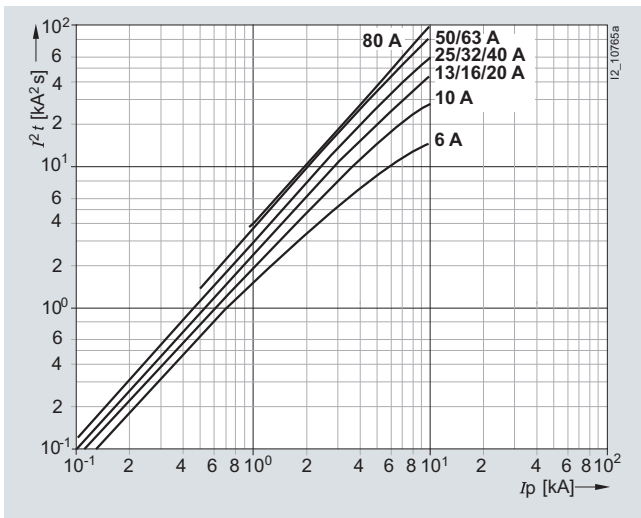

Characteristic D

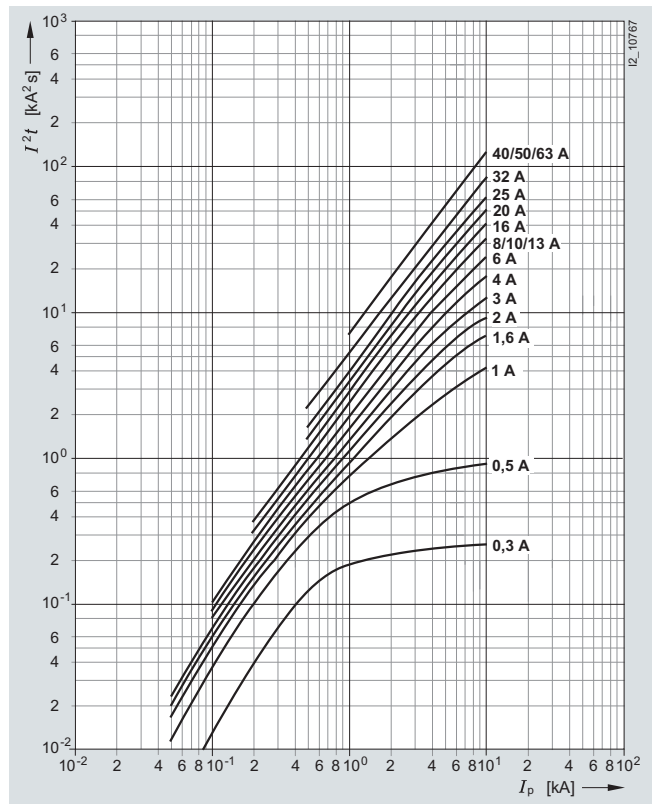

Configuration and dimensioning

Let-through I^2t values 5SP4 (AC)

Characteristic B

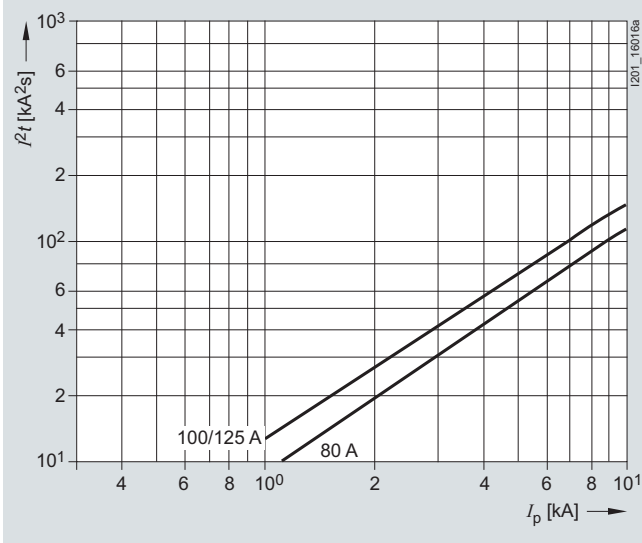

Characteristic D

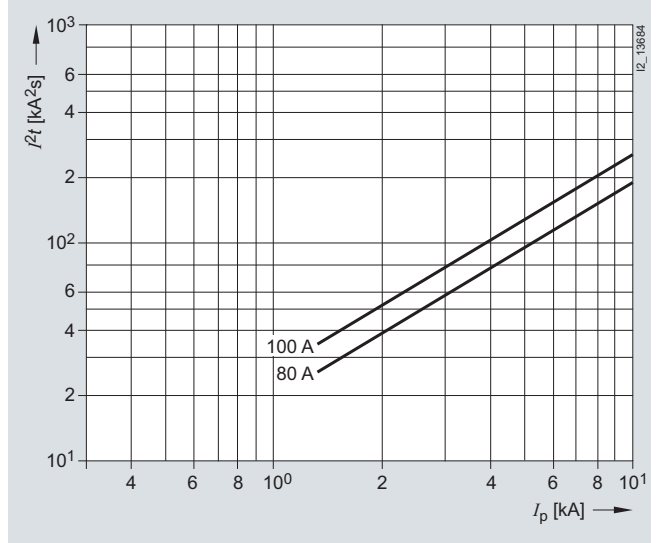

Characteristic C

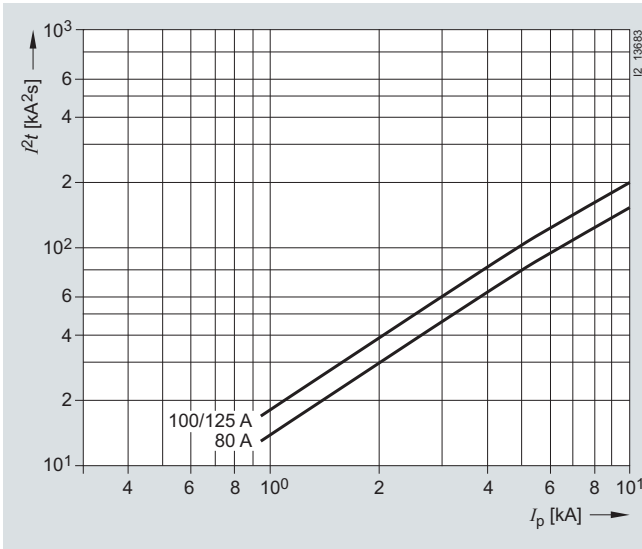

Let-through I^2t values 5SP5 (DC)

Characteristic C

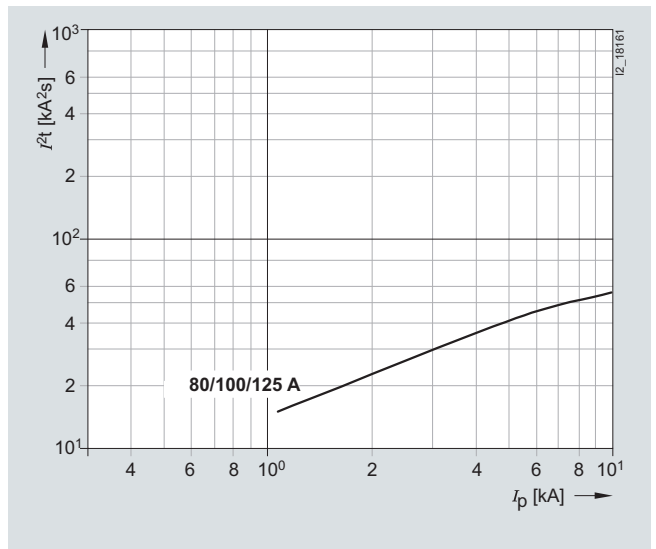

Miniature Circuit Breakers

Configuration and dimensioning

Let-through I^2t values 5SY5 (DC)

Characteristic B

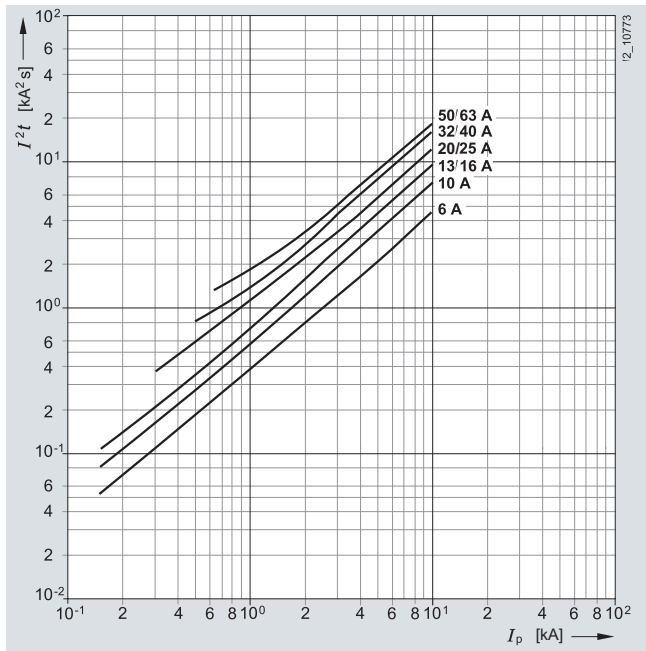

Characteristic C

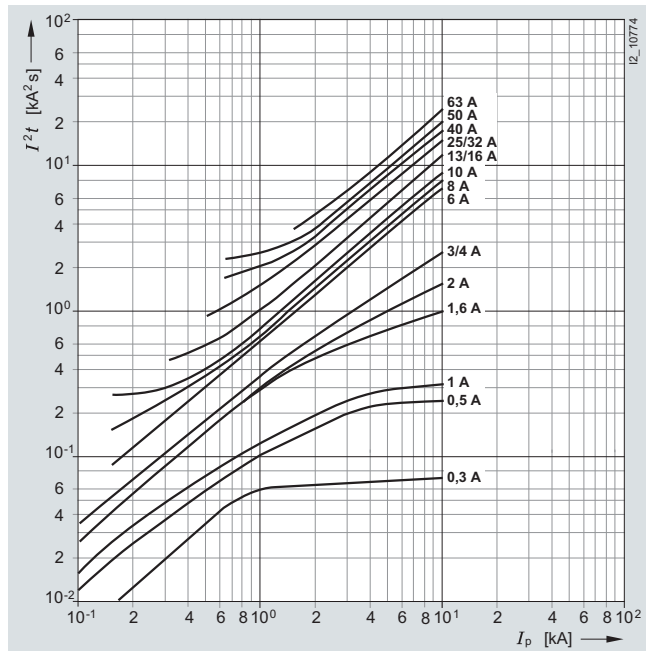

Let-through I^2t values 5SY8 (AC)

Characteristic C

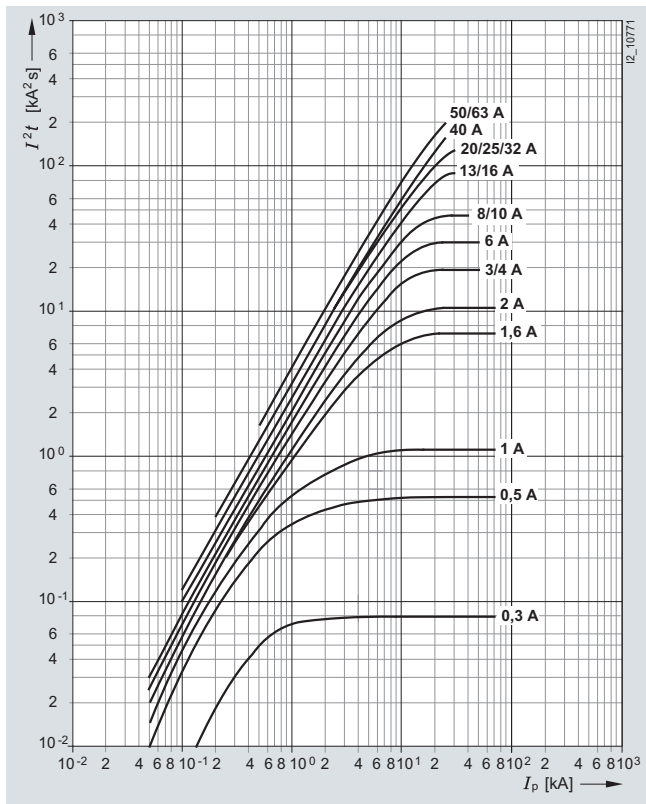

Characteristic D

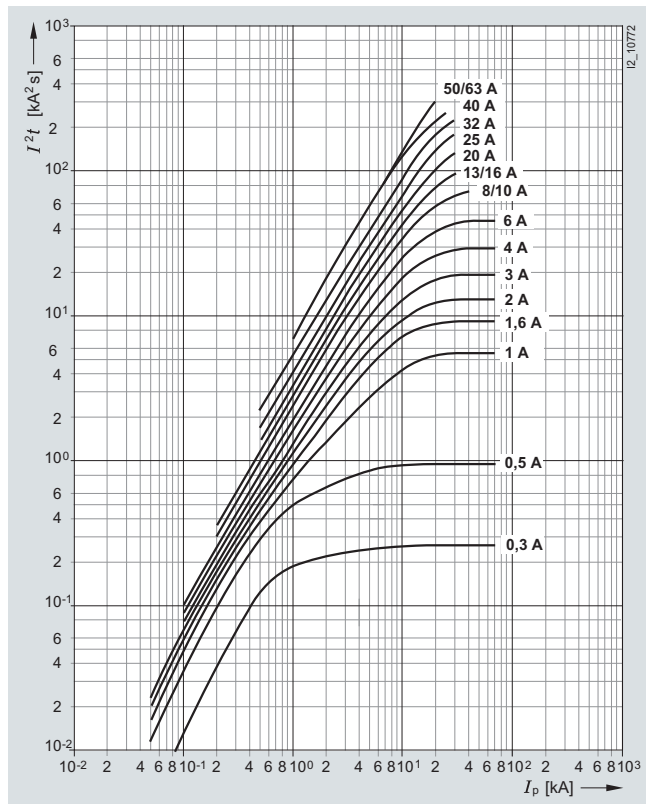

Configuration and dimensioning

Let-through I^2t values 5SY7 (AC)

Characteristic B

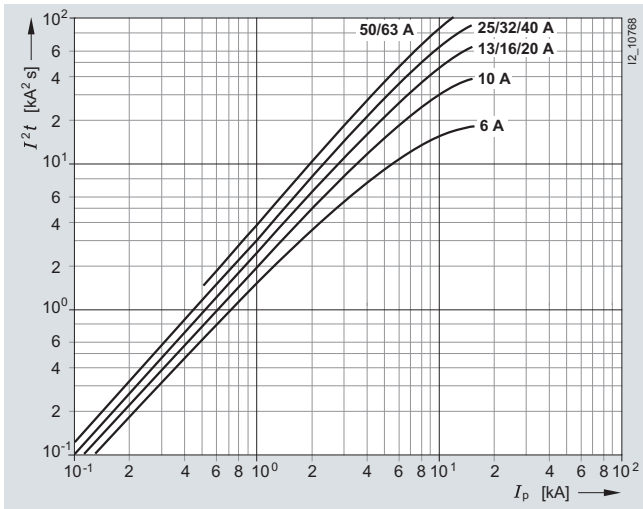

Characteristic C

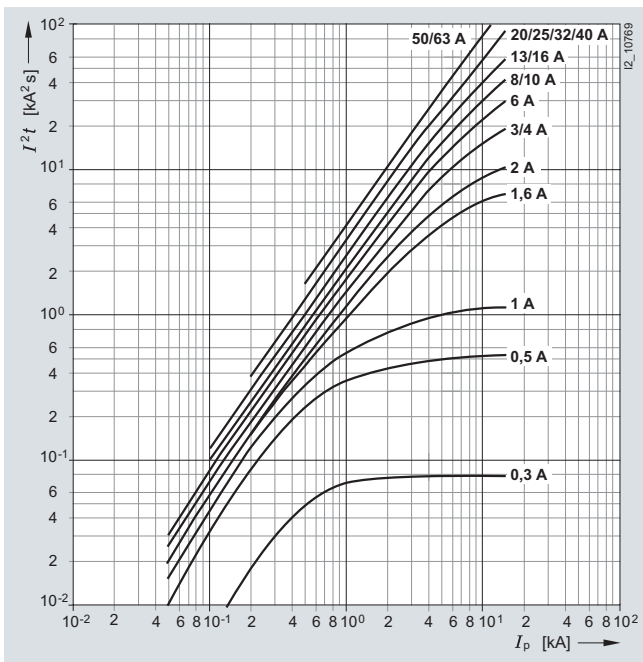

Characteristic D

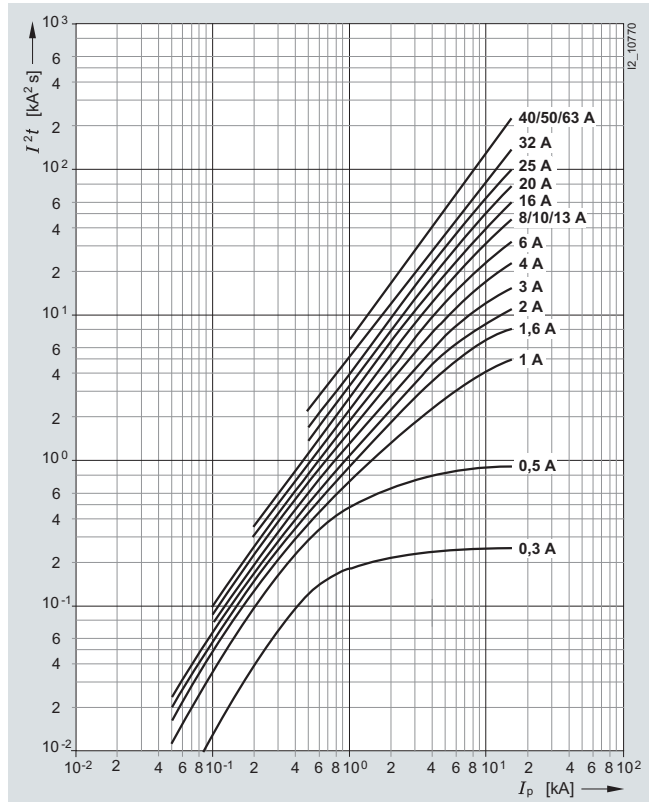

Miniature Circuit Breakers

Configuration and dimensioning

Let-through I^2t values 5SJ6 KS (AC)

Characteristic B

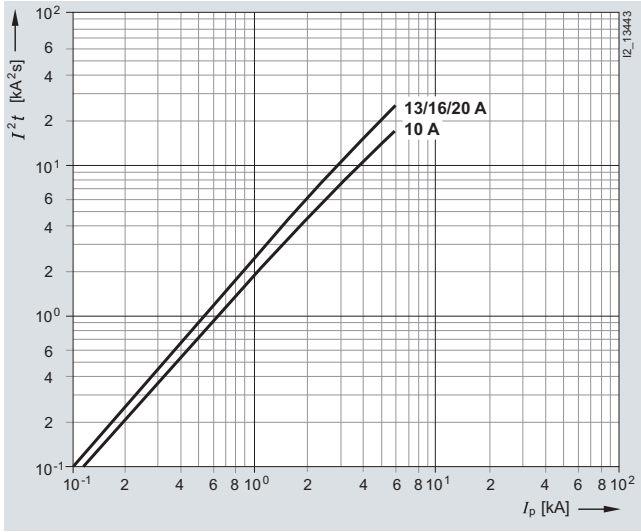

Characteristic C

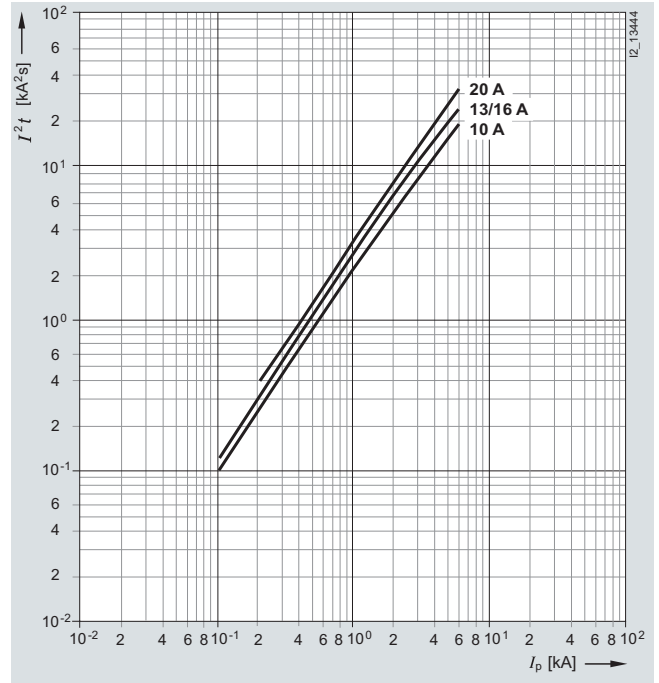

Let-through I^2t values 5SY6 0 (AC)

Characteristic B

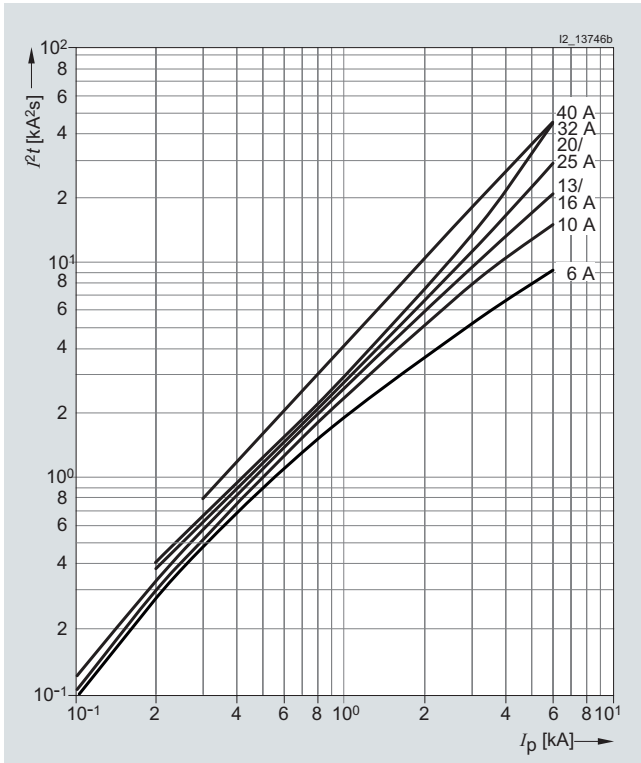

Characteristic C

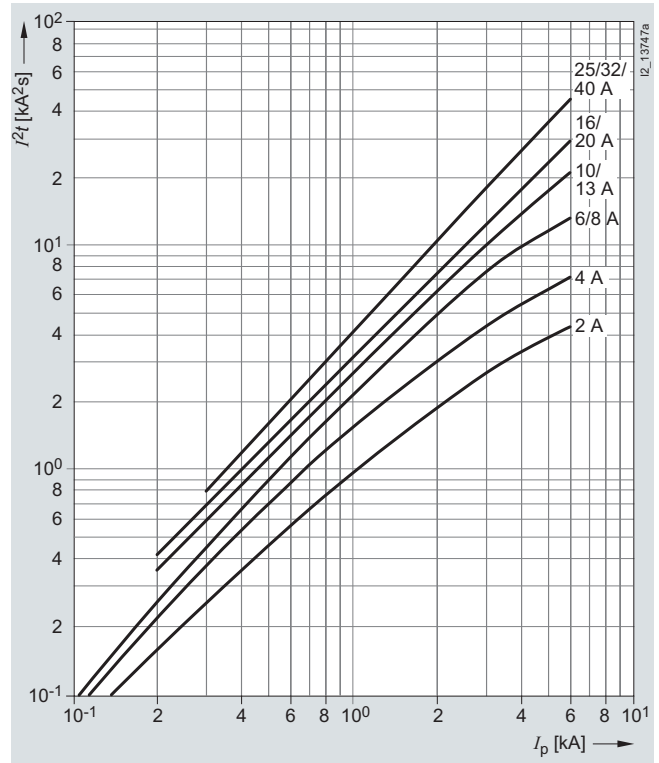

Selective miniature circuit breakers/fuses

Distribution systems are usually set up as radial networks. An overcurrent protection device is required for each reduction of the conductor cross-section. This produces a series connection staggered according to rated currents, which should, if possible, be "selective".

Selectivity means that, in the event of a fault, only the protective device that is directly next to the fault in the current circuit is tripped. This means that current paths in parallel can maintain a power flow.

In the case of miniature circuit breakers with upstream fuses, the selectivity limit depends largely on the current limitation and tripping characteristics of the miniature circuit breaker and the melting I^2t value of the fuse.

Limit values of selective line miniature circuit breakers/fuses in kA

Downstream miniature circuit breakers	I_n [A]	Upstream fuses								
		16 A	20 A	25 A	35 A	50 A	63 A	80 A	100 A	125 A
5SY4...-5, -6, 5SY7...-6										
Characteristic A, B	6	0.3	0.4	0.8	1.4	3.2	4.5	9.0	•	•
	10	--	0.4	0.7	1.2	2.5	3.5	5.0	•	•
	13	--	--	0.7	1.2	2.5	3.5	5.0	•	•
	16	--	--	--	1.0	2.0	2.8	4.2	9.0	•
	20	--	--	--	1.0	2.0	2.6	4.2	9.0	•
	25	--	--	--	--	1.7	2.2	3.7	7.0	•
	32	--	--	--	--	1.7	2.2	3.7	7.0	•
	40	--	--	--	--	--	1.6	2.2	4.0	6.0
	50	--	--	--	--	--	--	2.2	4.0	6.0
	63	--	--	--	--	--	--	--	3.0	5.0
5SY4...-7, 5SY7...-7										
Characteristic C	≤ 2	0.3	0.5	1.5	2.0	9.0	•	•	•	•
	3	0.3	0.4	1.1	1.6	5.0	6.0	•	•	•
	4	0.3	0.4	0.9	1.4	3.5	5.0	9.0	•	•
	6	--	0.4	0.8	1.4	2.7	4.5	6.0	•	•
	8	--	--	0.6	1.2	2.2	3.5	5.0	7.0	•
	10	--	--	0.5	1.2	2.0	3.0	4.2	7.0	•
	13	--	--	--	1.0	1.6	2.4	3.4	6.0	•
	16	--	--	--	1.0	1.5	2.2	3.0	6.0	•
	20	--	--	--	--	1.3	2.2	3.0	6.0	•
	25	--	--	--	--	--	2.2	2.9	5.0	9.0
	32	--	--	--	--	--	--	2.4	4.0	7.0
	40	--	--	--	--	--	--	2.0	3.5	4.0
	50	--	--	--	--	--	--	--	3.0	4.0
	63	--	--	--	--	--	--	--	3.0	3.5
5SY4...-8, 5SY7...-8										
Characteristic D	≤ 2	0.3	0.4	1.0	1.8	5.0	7.0	•	•	•
	3	0.3	0.4	0.9	1.5	4.0	5.0	8.0	•	•
	4	--	0.4	0.8	1.2	3.0	3.8	5.5	•	•
	6	--	--	0.7	1.1	2.5	3.1	4.4	8.1	•
	8	--	--	--	0.9	2.1	2.5	3.5	6.2	9.3
	10	--	--	--	--	2.1	2.5	3.5	6.2	9.3
	13	--	--	--	--	--	2.5	3.5	6.2	9.3
	16	--	--	--	--	--	2.2	3.1	5.1	7.5
	20	--	--	--	--	--	--	2.7	4.3	6.3
	25	--	--	--	--	--	--	--	4.0	5.7
	32	--	--	--	--	--	--	--	4.0	5.5
	40	--	--	--	--	--	--	--	3.5	4.8
	50	--	--	--	--	--	--	--	--	4.0
	63	--	--	--	--	--	--	--	--	--

- $\hat{=}$ rated switching capacity 5SY4 according to EN 60898-1 10 000

This produces different selectivity limits for miniature circuit breakers with different characteristics and rated switching capacity.

The following tables provide information on the short-circuit currents up to which selectivity exists between miniature circuit breakers and upstream fuse according to DIN VDE 0636-21. The values specified in kA are limit values that were determined under unfavorable test conditions. Under normal practical conditions, you can often expect considerably better values, depending on the upstream fuses.

In the event of a short-circuit, there is selectivity between the 5SY4, 5SY7, 5SP4 miniature circuit breakers and melting fuses according to DIN VDE 0636-21 up to the specified values in kA.

Miniature Circuit Breakers

Configuration and dimensioning

Limit values of selective line miniature circuit breakers/fuses in kA

Downstream Miniature circuit breakers	I_n [A]	Upstream fuses					
		100 A	125 A	160 A	200 A	224 A	250 A
5SP4...-6							
Characteristic B	80	2.8	3.8	5.7	8.1	•	•
	100	--	3.5	5.2	7.0	•	•
	125	--	--	5.2	7.0	•	•
5SP4...-7							
Characteristic C	80	2.5	3.5	5.1	7.5	9.2	•
	100	--	3.3	4.5	6.5	8.0	•
	125	--	--	4.5	6.5	8.0	•
5SP4...-8							
Characteristic D	80	2.3	3.3	4.6	6.9	8.1	•
	100	--	2.8	4.3	6.2	7.5	9.2

- \geq rated switching capacity 5SP4 according to EN 60898-1 10 000

Values for 5SY8 on request.

Selective miniature circuit breakers/motor starter protectors

Distribution systems can also be set up without fuses. In such cases, a circuit breaker acts as an upstream protective device. In this case, the selectivity limit depends on the level of peak current I let through by the miniature circuit breaker and the tripping current of the circuit breaker.

The following tables show the short-circuit current in kA up to which selectivity is guaranteed between miniature circuit breakers and upstream circuit breakers according to IEC/EN 60947-2 at 230/400 V AC, 50 Hz.

Limit values of selective miniature circuit breakers/circuit breakers in kA

Downstream miniature circuit breakers				Upstream circuit breakers								
I_n [A]	$I > [A]$	I_{cn} [kA]	3RV1.1			3RV1.2						
			10	12	8	10	12.5	16	20	22	25	
			120	144	96	120	150	192	240	264	300	
			50	50	100	100	100	50	50	50	50	
Selectivity limits [kA] ¹⁾												
5SY4...-5												
Characteristic A	2	6	10	0.2	0.2	--	--	0.2	0.2	0.6	1.2	1.5
	10	30	10	--	--	--	--	--	--	0.3	0.5	0.5
	16	48	10	--	--	--	--	--	--	0.3	0.4	0.5
	32	96	10	--	--	--	--	--	--	--	--	--
	40	120	10	--	--	--	--	--	--	--	--	--
5SY4...-6, 5SY7...-6												
Characteristic B	6	30	6/10/15	0.2	0.2	--	--	0.2	0.2	0.3	0.5	0.5
	10	50	6/10/15	--	0.2	--	--	0.2	0.2	0.3	0.4	0.5
	13	65	6/10/15	--	--	--	--	--	0.2	0.2	0.4	0.4
	16	80	6/10/15	--	--	--	--	--	--	0.2	0.4	0.4
	20	100	6/10/15	--	--	--	--	--	--	--	--	0.4
	25	125	6/10/15	--	--	--	--	--	--	--	--	--
	32	160	6/10/15	--	--	--	--	--	--	--	--	--
	40	200	6/10/15	--	--	--	--	--	--	--	--	--
	50	250	6/10/15	--	--	--	--	--	--	--	--	--
	63	315	6/10/15	--	--	--	--	--	--	--	--	--
	80	400	6/10/15	--	--	--	--	--	--	--	--	--
5SY4...-7, 5SY7...-7												
Characteristic C	0.5	5	6/10/15	0.2	0.2	0.1	0.1	0.2	0.2	0.5	0.6	0.6
	1	10	6/10/15	0.2	0.2	0.1	0.1	0.2	0.2	0.5	0.6	0.6
	1.6	16	6/10/15	0.2	0.2	0.1	0.1	0.2	0.2	0.5	0.6	0.6
	2	20	6/10/15	0.2	0.2	0.1	0.1	0.2	0.2	0.5	0.6	0.6
	3	30	6/10/15	--	0.2	--	--	0.2	0.2	0.3	0.4	0.5
	4	40	6/10/15	--	0.2	--	--	0.2	0.2	0.3	0.4	0.5
	6	60	6/10/15	--	0.2	--	--	0.2	0.2	0.3	0.4	0.5
	8	80	6/10/15	--	0.2	--	--	0.2	0.2	0.2	0.4	0.4
	10	100	6/10/15	--	0.2	--	--	0.2	0.2	0.2	0.4	0.4
	13	130	6/10/15	--	--	--	--	--	0.2	0.2	0.4	0.4
	16	160	6/10/15	--	--	--	--	--	--	0.2	0.4	0.4
	20	200	6/10/15	--	--	--	--	--	--	--	--	0.4
	25	250	6/10/15	--	--	--	--	--	--	--	--	--
	32	320	6/10/15	--	--	--	--	--	--	--	--	--
	40	400	6/10/15	--	--	--	--	--	--	--	--	--
	50	500	6/10/15	--	--	--	--	--	--	--	--	--
	63	630	6/10/15	--	--	--	--	--	--	--	--	--
	80	800	6/10/15	--	--	--	--	--	--	--	--	--
5SY4...-8, 5SY7...-8												
Characteristic D	2	40	6/10/15	--	--	--	--	0.2	0.2	0.4	0.6	0.6
	6	120	6/10/15	--	--	--	--	--	--	0.3	0.4	0.4
	10	200	6/10/15	--	--	--	--	--	--	0.2	0.4	0.4
	16	320	6/10/15	--	--	--	--	--	--	--	--	--
	32	640	6/10/15	--	--	--	--	--	--	--	--	--
	40	800	6/10/15	--	--	--	--	--	--	--	--	--
	50	1000	6/10/15	--	--	--	--	--	--	--	--	--
	63	1260	6/10/15	--	--	--	--	--	--	--	--	--

Values for 5SY8 on request.

¹⁾ In 240/415 V, 50 Hz systems, the selectivity limits are reduced by 10 %.
 $I > \hat{=}$ tripping current.

Miniature Circuit Breakers

Configuration and dimensioning

In the event of a short-circuit, selectivity up to the specified values in kA exists between miniature circuit breakers and motor starter protectors according to IEC/EN 60947-2.

Limit values of selective line miniature circuit breakers/fuses in kA

Downstream miniature circuit breakers				Upstream circuit breakers						
	I_n [A]	$I >$ [A]	I_{cn} [kA]	3RV1.3						
				16	20	25	32	40	45	50
				192	240	300	384	480	540	600
				50	50	50	50	50	50	50
				Selectivity limits [kA] ¹⁾						
5SY4...-5										
Characteristic A	2	6	10	0.2	0.8	1.2	2.5	3	6	6
	10	30	10	0.2	0.4	0.5	0.6	0.8	1	1.2
	16	48	10	--	0.3	0.4	0.6	0.8	0.8	1
	32	96	10	--	--	--	--	0.6	0.8	0.8
	40	120	10	--	--	--	--	--	--	0.8
5SY4...-6, 5SY7...-6										
Characteristic B	6	30	6/10/15	0.2	0.3	0.5	0.6	0.8	1	1.2
	10	50	6/10/15	0.2	0.3	0.4	0.6	0.8	1	1.2
	13	65	6/10/15	0.2	0.3	0.4	0.6	0.8	1	1
	16	80	6/10/15	--	0.3	0.4	0.6	0.8	1	1
	20	100	6/10/15	--	--	0.4	0.6	0.8	1	1
	25	125	6/10/15	--	--	--	0.5	0.6	0.8	0.8
	32	160	6/10/15	--	--	--	--	0.6	0.8	0.8
	40	200	6/10/15	--	--	--	--	--	--	0.8
	50	250	6/10/15	--	--	--	--	--	--	--
	63	315	6/10/15	--	--	--	--	--	--	--
80	400	6/10/15	--	--	--	--	--	--	--	
5SY4...-7, 5SY7...-7										
Characteristic C	0.5	5	6/10/15	0.3	0.5	0.6	1	1	1.5	3
	1	10	6/10/15	0.3	0.5	0.6	1	1	1.5	3
	1.6	16	6/10/15	0.3	0.5	0.6	1	1	1.5	3
	2	20	6/10/15	0.3	0.5	0.6	1	1	1.5	3
	3	30	6/10/15	0.2	0.3	0.4	0.6	0.8	1	1
	4	40	6/10/15	0.2	0.3	0.4	0.6	0.8	1	1
	6	60	6/10/15	0.2	0.3	0.4	0.6	0.8	1	1
	8	80	6/10/15	0.2	0.2	0.4	0.6	0.6	0.8	1
	10	100	6/10/15	0.2	0.2	0.4	0.6	0.6	0.8	1
	13	130	6/10/15	0.2	0.2	0.4	0.6	0.6	0.8	1
	16	160	6/10/15	--	0.2	0.4	0.6	0.6	0.8	1
	20	200	6/10/15	--	--	0.4	0.6	0.6	0.8	1
	25	250	6/10/15	--	--	--	0.5	0.6	0.8	0.8
	32	320	6/10/15	--	--	--	--	0.6	0.8	0.8
	40	400	6/10/15	--	--	--	--	--	--	0.8
	50	500	6/10/15	--	--	--	--	--	--	--
63	630	6/10/15	--	--	--	--	--	--	--	
80	800	6/10/15	--	--	--	--	--	--	--	
5SY4...-8, 5SY7...-8										
Characteristic D	2	40	6/10/15	0.3	0.5	0.6	0.8	1.2	1.5	1.5
	6	120	6/10/15	0.2	0.3	0.4	0.6	0.8	1	1
	10	200	6/10/15	--	0.3	0.4	0.5	0.6	0.8	0.8
	16	320	6/10/15	--	--	--	0.5	0.6	0.6	0.8
	32	640	6/10/15	--	--	--	--	--	0.6	0.6
	40	800	6/10/15	--	--	--	--	--	--	--
	50	1000	6/10/15	--	--	--	--	--	--	--
	63	1260	6/10/15	--	--	--	--	--	--	--

¹⁾ In 240/415 V, 50 Hz systems, the selectivity limits are reduced by 10 %.
 $I > \hat{=}$ tripping current.

In the event of a short-circuit, selectivity up to the specified values in kA exists between miniature circuit breakers and motor starter protectors according to IEC/EN 60947-2.

Limit values of selective miniature circuit breakers/circuit breakers in kA

Downstream miniature circuit breakers				Upstream circuit breakers									
I_n [A]	$I > [A]$	I_{cn} [kA]		3RV1.4									
				16	20	25	32	40	50	63	75	90	100
				192	240	300	384	480	600	756	900	1080	1140
				100	100	100	100	100	100	100	100	100	100
				Selectivity limits [kA] ¹⁾									
5SY4...-5													
Characteristic A	2	6	10	0.5	0.8	1.5	2.5	3	6/7.5	6/10	6/10	6/10	6/10
	10	30	10	0.3	0.4	0.5	0.6	0.8	1.2	1.5	2.5	3	4
	16	48	10	--	0.3	0.5	0.6	0.6	1	1.5	2	3	3
	32	96	10	--	--	--	--	0.6	0.8	1.5	2	2.5	3
	40	120	10	--	--	--	--	--	0.8	1.2	1.5	2	2
5SY4...-6, 5SY7...-6													
Characteristic B	6	30	6/10/15	0.2	0.4	0.5	0.6	0.8	1.2	2	3	6/10/15	6/10/15
	10	50	6/10/15	0.2	0.3	0.5	0.6	0.8	1	1.5	2.5	4	4
	13	65	6/10/15	0.2	0.3	0.5	0.6	0.8	1	1.5	2	3	3
	16	80	6/10/15	--	0.3	0.5	0.6	0.8	1	1.5	2	3	3
	20	100	6/10/15	--	--	0.5	0.6	0.8	1	1.5	2	3	3
	25	125	6/10/15	--	--	--	0.5	0.8	0.8	1.5	2	3	3
	32	160	6/10/15	--	--	--	--	0.6	0.8	1.5	2	3	3
	40	200	6/10/15	--	--	--	--	0.6	0.8	1.2	1.5	2.5	2.5
	50	250	6/10/15	--	--	--	--	--	--	1.2	1.5	2.5	2.5
5SY4...-7, 5SY7...-7													
Characteristic C	0.5	5	6/10/15	0.4	0.6	0.8	0.8	1	3	6/10/15	6/10/15	6/10/15	6/10/15
	1	10	6/10/15	0.4	0.6	0.8	0.8	1	3	6/10/15	6/10/15	6/10/15	6/10/15
	1.6	16	6/10/15	0.4	0.6	0.8	0.8	1	3	6/10/15	6/10/15	6/10/15	6/10/15
	2	20	6/10/15	0.4	0.6	0.8	0.8	1	3	6/10/15	6/10/15	6/10/15	6/10/15
	3	30	6/10/15	0.2	0.3	0.5	0.6	0.8	1	2	2.5	5	5
	4	40	6/10/15	0.2	0.3	0.5	0.6	0.8	1	2	2.5	5	5
	6	60	6/10/15	0.2	0.3	0.5	0.6	0.8	1	2	2.5	5	5
	8	80	6/10/15	0.2	0.3	0.4	0.6	0.6	1	1.5	2	3	3
	10	100	6/10/15	0.2	0.3	0.4	0.6	0.6	1	1.5	2	3	3
	13	130	6/10/15	0.2	0.3	0.4	0.6	0.6	1	1.5	2	3	3
	16	160	6/10/15	--	0.3	0.4	0.6	0.6	1	1.5	2	3	3
	20	200	6/10/15	--	--	0.4	0.6	0.6	1	1.5	2	3	3
	25	250	6/10/15	--	--	--	0.5	0.6	0.8	1.2	1.5	2.5	2.5
	32	320	6/10/15	--	--	--	--	0.6	0.8	1.2	1.5	2.5	2.5
	40	400	6/10/15	--	--	--	--	--	0.6	1	1.5	2	2
	50	500	6/10/15	--	--	--	--	--	--	1	1.2	1.5	2
	63	630	6/10/15	--	--	--	--	--	--	--	--	1.5	1.5
5SY4...-8, 5SY7...-8													
Characteristic D	2	40	6/10/15	0.4	0.5	0.6	0.8	1	1.5	3	4	6/10/15	6/10/15
	6	120	6/10/15	0.2	0.3	0.4	0.6	0.6	1	1.5	2.5	3	3
	10	200	6/10/15	--	0.3	0.4	0.5	0.6	0.8	1.5	2	3	3
	16	320	6/10/15	--	--	--	0.5	0.6	0.8	1.2	1.5	2.5	2.5
	32	640	6/10/15	--	--	--	--	--	0.6	1	1.5	2	2
	40	800	6/10/15	--	--	--	--	--	--	1	1.2	1.5	1.5
	50	1000	6/10/15	--	--	--	--	--	--	1	1.2	1.5	1.5
5SP4...-7													
Characteristic C	80	1600	10	--	--	--	--	--	--	--	--	--	1.2
	100	2000	10	--	--	--	--	--	--	--	--	--	--
5SP4...-8													
Characteristic D	80	1600	10	--	--	--	--	--	--	--	--	--	--
	100	2000	10	--	--	--	--	--	--	--	--	--	--

Values for 5SY8 on request.

¹⁾ In 240/415 V, 50 Hz systems, the selectivity limits are reduced by 10 %.

$I > \hat{=}$ tripping current.

Miniature Circuit Breakers

Configuration and dimensioning

In the event of a short-circuit, selectivity up to the specified values in kA exists between miniature circuit breakers and motor starter protectors according to IEC/EN 60947-2.

Limit values of selective miniature circuit breakers/circuit breakers in kA

Downstream miniature circuit breakers			Upstream circuit breakers											
I_n [A]	$I >$ [A]	I_{cn} [kA]	3VL1, TM Non-adjustable						3VL2, TM adjustable					
			50	63	80	100	125	160	50	63	80	100	125	160
			500	630	800	1000	1250	1600	400	500	630	800	1000	1280
			40/70/100	40/70/100	40/70/100	40/70/100	40/70/100	40/70/100	40/70/100	40/70/100	40/70/100	40/70/100	40/70/100	40/70/100
			Selectivity limits [kA] ¹⁾											
5SY4...-5														
Characteristic A	2	6 10	10	10	10	10	10	10	10	10	10	10	10	10
	10	30 10	1.6	4.7	6	10	10	10	10	2.5	4	4	4.5	4.9
	16	48 10	1.4	4.7	6	10	10	10	2.3	3.7	3.7	4.4	5	10
	32	96 10	1.2	3.6	4.6	10	10	10	1.8	3	3	3.5	3.7	6
	40	120 10	1	2.5	3.1	6	10	10	1.5	2	2	2.4	2.7	3.2
5SY4...-6, 5SY7...-6														
Characteristic B	6	30 6/10/15	5.5	5.5	T	T	T	T	2.5	2.5	5.1	7.3	T	T
	10	50 6/10/15	3.1	3.1	6.7	6.7	6.7	6/12/4	2.0	2.0	3.0	3.9	5.0	8.6
	13	65 6/10/15	2.5	2.5	5.0	5.0	5.0	8.0	1.5	1.5	3.1	3.4	4.5	5.8
	16	80 6/10/15	2.5	2.5	4.4	4.4	4.4	7.2	1.5	1.5	2.0	3.1	4.0	5.1
	20	100 6/10/15	2.0	2.0	4.3	4.3	4.3	6.6	1.5	1.5	2.0	2.5	3.9	5.0
	25	125 6/10/15	2.0	2.0	3.9	3.9	3.9	6.1	1.5	1.5	2.0	2.1	3.4	4.6
	32	160 6/10/15	2.0	2.0	3.7	3.7	3.7	5.0	1.5	1.5	2.0	2.1	3.4	4.8
	40	200 6/10/15	2.0	2.0	3.7	3.7	3.7	5.0	1.2	1.2	2.0	2.1	3.3	4.3
50	250 6/10/15	--	1.5	3.2	3.2	3.2	4.0	--	--	1.5	2.0	2.5	3.6	
5SY4...-7, 5SY7...-7														
Characteristic C	0.5	5 6/10/15	T	T	T	T	T	T	T	T	T	T	T	T
	1	10 6/10/15	T	T	T	T	T	T	T	T	T	T	T	T
	1.5	15 6/10/15	T	T	T	T	T	T	T	T	T	T	T	T
	2	20 6/10/15	T	T	T	T	T	T	T	T	T	T	T	T
	3	30 6/10/15	3.2	3.2	T	T	T	T	2.5	T	T	T	T	T
	4	40 6/10/15	3.2	3.2	T	T	T	T	2.5	T	T	T	T	T
	6	60 6/10/15	3.2	3.2	7	7	7	6/10/13.9	2.5	2.5	5.1	7.3	T	T
	8	80 6/10/15	2.5	2.5	5.4	5.4	5.4	6/9/2	2.3	3.7	3.8	3.9	5.6	8.6
	10	100 6/10/15	2.5	2.5	5.4	5.4	5.4	6/9/2	2.0	2.0	3.0	3.4	5.6	8.6
	13	130 6/10/15	2.5	2.5	4.3	4.3	4.3	7.1	1.5	1.5	2.5	3.4	4.5	5.8
	16	160 6/10/15	2.0	2.5	4.0	4.0	4.0	7.1	1.5	1.5	2.5	3.1	4.0	5.1
	20	200 6/10/15	2.0	2.0	3.7	3.7	3.7	6.3	1.5	1.5	2.0	2.5	3.9	5.0
25	250 6/10/15	2.0	2.0	3.6	3.6	3.6	5.5	1.5	1.5	2.0	2.5	3.5	4.6	
32	320 6/10/15	2.0	2.0	3.5	3.5	3.5	5.5	1.5	1.5	2.0	2.5	3.4	4.5	
40	400 6/10/15	1.5	1.5	3.3	3.3	3.3	5.1	1.2	1.2	2.0	2.5	3.3	4.3	
50	500 6/10/15	--	1.5	3.1	3.1	3.1	4.0	--	--	1.5	2.5	2.5	3.6	
5SY4...-8, 5SY7...-8														
Characteristic D	2	40 6/10/15	2.4	6	6	6	6	6	4.2	6	6	6	6	6
	6	120 6/10/15	1.4	1.4	4.8	5	6	6	2.3	4.1	4.2	4.2	4.3	6
	10	200 6/10/15	1.3	1.3	4.5	5	6	6	1.9	3.7	3.7	3.7	4	6
	16	320 6/10/15	1.1	1.1	3.2	3.2	3.2	4.0	1.7	3.3	3.7	3.3	3.5	4.7
	32	640 6/10/15	--	--	2.3	2.3	2.3	4.0	--	--	--	2.4	2.7	3.7
	40	800 6/10/15	--	--	--	2.1	2.1	3.8	--	--	--	--	1.5	3
50	1000 6/10/15	--	--	--	--	2.0	2.8	--	--	--	--	--	2.6	
5SP4...-7														
Characteristic C	80	800 10	--	--	--	1.0	1.2	2.0	--	--	--	--	1.2	1.5
	100	1000 10	--	--	--	--	1.2	1.5	--	--	--	--	--	1.5
5SP4...-8														
Characteristic D	80	1600 10	--	--	--	--	--	--	--	--	--	--	--	--
	100	1200 10	--	--	--	--	--	--	--	--	--	--	--	--

Values for 5SY8 on request.

T $\hat{=}$ full selectivity up to rated breaking capacity I_{cn} of the downstream protective device.

¹⁾ In 240/415 V, 50 Hz systems, the selectivity limits are reduced by 10 %.
The selectivity limits for adjustable releases apply to the maximum value,
 I_n = rated current. $I >$ $\hat{=}$ tripping current.

In the event of a short-circuit, selectivity up to the specified values in kA exists between miniature circuit breakers and motor starter protectors according to IEC/EN 60947-2.

Limit values of selective miniature circuit breakers/circuit breakers in kA

Downstream miniature circuit breakers	Upstream circuit breakers											
	3VL3, TM		3VL4, TM		3VL6, ETU		3VL7, ETU		3VL8, ETU		3WN1	3WN6
I_n [A]	200	250	200	250	315	400	315	400 ...	400 ...	800 ...	315 ...	315 ...
$I >$ [A]	2000	2500	2000	2500	3150	4000	3200	800	1250	2500	6300	3200
I_{cn} [kA]	40 ... 100	40 ... 100	45 ... 100	45 ... 100	45 ... 100	45 ... 100	45 ... 100	1575 ...	15000	20000	3780 ...	3780 ...
	Selectivity limits [kA] ¹⁾											

5SY4...-5, 5SY7...-5

Characteristic A

2	6	10	T	T	T	T	T	T	T	T	T	T	T
10	30	10	T	T	T	T	T	T	T	T	T	T	T
16	48	10	T	T	T	T	T	T	T	T	T	T	T
32	96	10	T	T	T	T	T	T	T	T	T	T	T
40	120	10	T	T	T	T	T	T	T	T	T	T	T

5SY4...-6, 5SY7...-6

Characteristic B

6	30	6/10/15	T	T	T	T	T	T	T	T	T	T	T
10	50	6/10/15	T	T	T	T	T	T	T	T	T	T	T
13	65	6/10/15	T	T	T	T	T	T	T	T	T	T	T
16	80	6/10/15	T	T	T	T	T	T	T	T	T	T	T
20	100	6/10/15	T	T	T	T	T	T	T	T	T	T	T
25	125	6/10/15	T	T	T	T	T	T	T	T	T	T	T
32	160	6/10/15	T	T	T	T	T	T	T	T	T	T	T
40	200	6/10/15	6	6	6	T	T	T	T	T	T	T	T
50	250	6/10/15	6	6	6/10/14.1	T	T	T	T	T	T	T	T

5SY4...-7, 5SY7...-7

Characteristic C

0.5	5	6/10/15	T	T	T	T	T	T	T	T	T	T	T
1	10	6/10/15	T	T	T	T	T	T	T	T	T	T	T
1.5	15	6/10/15	T	T	T	T	T	T	T	T	T	T	T
2	20	6/10/15	T	T	T	T	T	T	T	T	T	T	T
3	30	6/10/15	T	T	T	T	T	T	T	T	T	T	T
4	40	6/10/15	T	T	T	T	T	T	T	T	T	T	T
6	60	6/10/15	T	T	T	T	T	T	T	T	T	T	T
8	80	6/10/15	T	T	T	T	T	T	T	T	T	T	T
10	100	6/10/15	T	T	T	T	T	T	T	T	T	T	T
13	130	6/10/15	T	T	T	T	T	T	T	T	T	T	T
16	160	6/10/15	T	T	T	T	T	T	T	T	T	T	T
20	200	6/10/15	T	T	T	T	T	T	T	T	T	T	T
25	250	6/10/15	T	T	T	T	T	T	T	T	T	T	T
32	320	6/10/15	6/10/11	T	T	T	T	T	T	T	T	T	T
40	400	6/10/15	6/10	T	T	T	T	T	T	T	T	T	T
50	500	6/10/15	6/10	T	T	T	T	T	6/10/14.2	T	T	T	T

5SY4...-8, 5SY7...-8

Characteristic D

2	40	6/10/15	T	T	T	T	T	T	T	T	T	T	T
6	120	6/10/15	T	T	T	T	T	T	T	T	T	T	T
10	200	6/10/15	T	T	T	T	T	T	T	T	T	T	T
16	320	6/10/15	T	T	T	T	T	T	T	T	T	T	T
32	640	6/10/15	T	T	T	T	T	T	T	T	T	T	T
40	800	6/10/15	T	T	T	T	T	T	T	T	T	T	T
50	1000	6/10/15	T	T	T	T	T	T	T	T	T	T	T

5SP4...-7

Characteristic C

80	800	10	3	3	3	3	3	6	8	T	T	T	T	T
100	1000	10	3	3	3	3	3	5	6	T	T	T	T	T

5SP4...-8

Characteristic D

80	1600	10	3	3	2.5	3	3	5	6	T	T	T	T	T
100	2000	10	--	2.5	--	3	3	5	6	T	T	T	T	T

Values for 5SY8 on request.

T $\hat{=}$ full selectivity up to rated breaking capacity I_{cn} of the downstream protective device.

¹⁾ In 240/415 V, 50 Hz systems, the selectivity limits are reduced by 10 %.
The selectivity limits for adjustable releases apply to the maximum value,
 I_n = rated current. $I >$ = tripping current.

Miniature Circuit Breakers

Configuration and dimensioning

Within narrow limits, miniature circuit breakers also offer selectivity between circuit breakers in a fuseless distribution board. The following table shows the short-circuit current in kA up to which there is selectivity between series-connected miniature circuit breakers at 230 V AC.

This depends on the let-through peak current \hat{i} of the downstream miniature circuit breaker and on the tripping current of the upstream miniature circuit breaker.

Limit values of selective miniature circuit breakers/circuit breakers in kA

Downstream miniature circuit breakers				Upstream miniature circuit breakers									
I_n [A]	$I > [A]$	I_{cn} [kA]		5SY4...-7 Characteristic C						5SP4...-7 Characteristic C		5SP4...-8 Characteristic D	
				20	25	32	40	50	63	80	100	80	100
				200	250	320	400	500	630	800	1000	1200	1500
				10	10	10	10	10	10	10	10	10	10
				Selectivity limits [kA] ¹⁾									
5SY...-6 (without 5SY6 0...-6)													
Characteristic B	6	30	6/10/15	0.2	0.2	0.3	0.5	0.5	0.6	0.8	1.5	3	5
	10	50	6/10/15	0.2	0.2	0.3	0.5	0.5	0.6	0.8	1.2	3	4
	13	65	6/10/15	0.2	0.2	0.3	0.4	0.5	0.5	0.8	1.2	2	3
	16	80	6/10/15	0.2	0.2	0.3	0.4	0.5	0.5	0.8	1.2	2	3
	20	100	6/10/15	--	0.2	0.3	0.4	0.5	0.5	0.8	1.2	2	3
	25	125	6/10/15	--	--	--	0.4	0.4	0.6	0.6	1.2	1.5	3
	32	160	6/10/15	--	--	--	0.4	0.4	--	0.6	1.2	1.5	3
	40	200	6/10/15	--	--	--	--	0.4	--	0.6	1.2	1.5	2.5
	50	250	6/10/15	--	--	--	--	--	--	0.6	1	1.5	2.5
5SY...-7 (without 5SY6 0...-7)													
Characteristic C	0.5	5	6/10/15	0.2	0.3	0.5	0.8	0.8	0.8	1.2	4	T	T
	1	10	6/10/15	0.2	0.3	0.5	0.8	0.8	0.8	1.2	4	T	T
	1.5	15	6/10/15	0.2	0.3	0.5	0.8	0.8	0.8	1.2	4	T	T
	2	20	6/10/15	0.2	0.3	0.5	0.8	0.8	0.8	1.2	4	T	T
	3	30	6/10/15	0.2	0.2	0.3	0.5	0.5	0.8	0.8	1.5	3	4
	4	40	6/10/15	0.2	0.2	0.3	0.5	0.5	0.6	0.8	1.5	3	4
	6	60	6/10/15	0.2	0.2	0.3	0.5	0.5	0.6	0.8	1.5	3	4
	8	80	6/10/15	0.2	0.2	0.3	0.4	0.4	0.6	0.6	1.2	2.5	3
	10	100	6/10/15	0.2	0.2	0.3	0.4	0.4	0.6	0.6	1.2	2.5	3
	13	130	6/10/15	0.2	0.2	0.3	0.4	0.4	0.5	0.6	1.2	2	3
	16	160	6/10/15	0.2	0.2	0.3	0.4	0.4	0.5	0.6	1.2	2	3
	20	200	6/10/15	--	0.2	0.3	0.4	0.4	0.5	0.6	1.2	2	3
	25	250	6/10/15	--	--	--	0.3	0.4	0.5	0.6	1	1.5	2.5
	32	320	6/10/15	--	--	--	0.3	0.4	--	0.6	1	1.5	2.5
	40	400	6/10/15	--	--	--	--	--	--	--	0.8	1.5	2
	50	500	6/10/15	--	--	--	--	--	--	--	0.8	1.5	2
	63	630	6/10/15	--	--	--	--	--	--	--	0.8	1.2	1.5

T $\hat{=}$ full selectivity up to rated breaking capacity I_{cn} of the downstream protective device.

¹⁾ In 240/415 V, 50 Hz systems, the selectivity limits are reduced by 10 %.
The selectivity limits for adjustable releases apply to the maximum value,
 I_n = rated current. $I >$ $\hat{=}$ tripping current.

Back-up protection miniature circuit breakers/fuses

If the maximum short-circuit current of the miniature circuit breaker at the installation site is unknown, or if the specified rated switching capacity is exceeded, an additional protective device must be connected upstream as back-up protection to prevent overloading of the miniature circuit breaker. This is usually a fuse.

The following table shows the short-circuit currents in kA up to which back-up protection is guaranteed when using fuses according to DIN VDE 0636-21.

Limit values of back-up protection miniature circuit breakers/fuses in kA

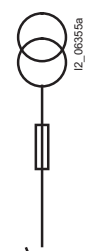
Downstream miniature circuit breakers	I_n [A]	Upstream fuses					
		50 A	63 A	80 A	100 A	125 A	160 A
	0.3 ... 6	No back-up protection required ¹⁾					
	8	50	50	50	50	45	45
	10	50	50	50	50	45	45
	13	50	50	50	45	40	35
	16	50	50	50	45	40	35
	20	50	50	50	40	35	30
	25	50	50	50	40	35	30
	32	50	50	50	45	40	30
	40	50	50	50	45	40	30
	50	50	50	50	40	35	25
	63	50	50	45	40	35	25

Test circuit data:

$U_p = 250$ V
p.f. = 0.3 ... 0.5

Test cycle:

Acc. to EN 60947-2 (0 - C0)

¹⁾ Up to the respective I_{cu} according to the Table "Rated switching capacity" on page 21.

Miniature Circuit Breakers

Configuration and dimensioning

Back-up protection miniature circuit breakers/circuit breakers

If miniature circuit breakers are installed in fuseless distribution boards, circuit breakers according to IEC/EN 60947-2 must be used as back-up protection.

The following tables show the short-circuit currents – in kA – up to which back-up protection is guaranteed when using circuit breakers.

Limit values of back-up protection miniature circuit breakers/circuit breakers in kA

Downstream miniature circuit breakers		Upstream circuit breakers																	
		3VL1 Non-adjustable												3VL2 Adjustable					
I_n [A]	I_n [A]	16	20	25	32	40	50	63	80	100	125	160	50	63	80	100	125	160	
$I > [A]$	I_{cu} [kA]	160	200	250	320	400	500	630	800	1000	1250	1600	400	500	630	800	1000	1280	
I_n [A]	I_{cn} [kA]	40/70	40/70	40/70	40/70	40/70	40/70	40/70	40/70	40/70	40/70	40/70	40/70	40/70	40/70	40/70	40/70	40/70	
		Back-up protection up to kA																	
5SY4																			
 Characteristic A, B, C, D	0.3 ... 6	10	40	40	40	40	40	40	40	40	40	40	40	40	40	40	40	40	
	8 ... 32	10	30	30	30	30	30	30	30	30	30	30	30	30	30	30	30	30	30
	40 ... 63	10	25	25	25	25	25	25	25	25	25	25	25	25	25	25	25	25	25
5SY7																			
Characteristic B, C	0.3 ... 2	15	50	50	50	50	50	50	50	50	50	50	50	50	50	50	50	50	
	3 ... 10	15	45	45	45	45	45	45	45	45	45	45	45	45	45	45	45	45	
	13 ... 32	15	40	40	40	40	40	40	40	40	40	40	40	40	40	40	40	40	
	40 ... 63	15	35	35	35	35	35	35	35	35	35	35	35	35	35	35	35	35	
Characteristic D	0.3 ... 2	15	50	50	50	50	50	50	50	50	50	50	50	50	50	50	50	50	
	3 ... 10	15	45	45	45	45	45	45	45	45	45	45	45	45	45	45	45	45	
	13 ... 32	15	40	40	40	40	40	40	40	40	40	40	40	40	40	40	40	40	
	40 ... 63	15	35	35	35	35	35	35	35	35	35	35	35	35	35	35	35	35	
5SY8																			
Characteristic C	0.3 ... 2	25	70	70	70	70	70	70	70	70	70	70	70	70	70	70	70	70	
	3 ... 6	25	50	50	50	50	50	50	50	50	50	50	50	50	50	50	50	50	
	8 ... 32	25	45	45	45	45	45	45	45	45	45	45	45	45	45	45	45	45	
	40 ... 63	25	40	40	40	40	40	40	40	40	40	40	40	40	40	40	40	40	
Characteristic D	0.3 ... 2	25	70	70	70	70	70	70	70	70	70	70	70	70	70	70	70	70	
	3 ... 6	25	50	50	50	50	50	50	50	50	50	50	50	50	50	50	50	50	
	8 ... 32	25	45	45	45	45	45	45	45	45	45	45	45	45	45	45	45	45	
	40 ... 63	25	40	40	40	40	40	40	40	40	40	40	40	40	40	40	40	40	
5SP4																			
Characteristic B, C	80 ... 125	10	25	25	25	25	25	25	25	25	25	25	25	25	25	25	25	25	
Characteristic D	80 ... 100	10	20	20	20	20	20	20	20	20	20	20	20	20	20	20	20	20	

Downstream miniature circuit breakers			Upstream circuit breakers													
			3VL3			3VL4				3VL5				3VL6	3VL7	3VL8
I_n [A]			200	250	200	250	315	400	250 ... 315	315 ... 400	400 ... 500	500 ... 630	320 ... 800	400 ... 1250	1600 ... 2000	315 ... 6300
$I >$ [A]			2000	2500	2000	2500	3150	4000	2500 ... 3150	3150 ... 4000	4000 ... 5000	5000 ... 6300	3200 ... 6300	15000	20000	3780 ... 75600
I_{cn} [kA]			40/70/ 100	40/70/ 100	45/70/ 100	45/70/ 100	45/70/ 100	45/70/ 100	45/70/ 100	45/70/ 100	45/70/ 100	45/70/ 100	45/70/ 100	50/70/ 100	70/100	65 ... 100
I_n [A]	I_{cn} [kA]		Back-up protection up to kA													
5SY4																
Characteristic A, B, C, D	0.3 ... 6	10	40	40	40	40	40	40	40	40	40	40	40	40	40	40
	8 ... 32	10	30	30	30	30	30	30	30	30	30	30	30	30	30	30
	40 ... 63	10	25	25	25	25	25	25	25	25	25	25	25	25	25	25
5SY7																
Characteristic B, C	0.3 ... 2	10	50	50	50	50	50	50	50	50	50	50	50	50	50	50
	3 ... 10	10	45	45	45	45	45	45	45	45	45	45	45	45	45	45
	13 ... 32	10	40	40	40	40	40	40	40	40	40	40	40	40	40	40
	40 ... 63	10	35	35	35	35	35	35	35	35	35	35	35	35	35	35
Characteristic D	0.3 ... 2	10	50	50	50	50	50	50	50	50	50	50	50	50	50	50
	3 ... 10	10	45	45	45	45	45	45	45	45	45	45	45	45	45	45
	13 ... 32	10	40	40	40	40	40	40	40	40	40	40	40	40	40	40
	40	10	35	35	35	35	35	35	35	35	35	35	35	35	35	35
	50 ... 63	10	30	30	30	30	30	30	30	30	30	30	30	30	30	30
5SY8																
Characteristic C	0.3 ... 2	25	70	70	70	70	70	70	70	70	70	70	70	--	--	--
	3 ... 6	25	50	50	50	50	50	50	50	50	50	50	50	--	--	--
	8 ... 32	25	45	45	45	45	45	45	45	45	45	45	45	--	--	--
	40 ... 63	25	40	40	40	40	40	40	40	40	40	40	40	--	--	--
Characteristic D	0.3 ... 2	25	70	70	70	70	70	70	70	70	70	70	70	--	--	--
	3 ... 6	25	50	50	50	50	50	50	50	50	50	50	50	--	--	--
	8 ... 32	25	45	45	45	45	45	45	45	45	45	45	45	--	--	--
	40	25	40	40	40	40	40	40	40	40	40	40	40	--	--	--
	50 ... 63	25	35	35	35	35	35	35	35	35	35	35	35	--	--	--
5SP4																
Characteristic B, C	80 ... 125	10	25	25	25	25	25	25	25	25	25	25	25	--	--	--
Characteristic D	80 ... 100	10	20	20	20	20	20	20	20	20	20	20	20	--	--	--

Miniature Circuit Breakers

Configuration and dimensioning

Internal resistance R_i and power loss P_v of 5SL6 miniature circuit breakers
(data per pole with I_n)

I_n A	Characteristic B		Characteristic C	
	R_i mΩ	P_v mW	R_i mΩ	P_v mW
0.3	--	--	10500	0.9
0.5	--	--	3400	0.9
1	--	--	1210	1.2
1.6	--	--	459	1.2
2	375	1.5	295	1.2
3	--	--	137	1.2
4	91	1.45	81	1.3
6	23.3	0.8	17.1	0.6
8	--	--	10.9	0.7
10	14.9	1.5	12.1	1.2
13	11.0	1.9	10.6	1.8
16	7.6	1.9	6.6	1.7
20	5.2	2.1	5.1	2.0
25	4.0	2.5	3.7	2.3
32	2.3	2.4	2.4	2.5
40	2.1	3.4	2.1	3.3
50	1.5	3.8	1.4	3.5
63	1.4	5.4	1.1	4.4

Internal resistance R_i and power loss P_v of miniature circuit breakers: 5SY4, 5SY7, 5SY8, 5SY5, 5SP4 and 5SP5
(data per pole with I_n)

I_n A	Characteristic A		Characteristic B		Characteristic C		Characteristic D	
	R_i mΩ	P_v W	R_i mΩ	P_v W	R_i mΩ	P_v W	R_i mΩ	P_v W
0.3	--	--	--	--	10500	0.9	10200	1
0.5	--	--	--	--	3400	0.9	3120	0.8
1	1955	2.0	--	--	1210	1.2	1030	1.0
1.6	786	2.0	--	--	459	1.2	409	1.1
2	510	2.0	375	1.5	295	1.2	292	1.2
3	205	1.9	--	--	137	1.2	131	1.2
4	134	2.1	91	1.45	81	1.3	73	1.2
6	58	2.1	55	2.0	44	1.6	43	1.6
8	27	1.7	--	--	14	0.9	12	0.7
10	18.1	1.8	13	1.3	10	1.0	8.4	0.8
13	11.4	1.9	9.5	1.6	8.0	1.4	8.0	1.4
16	8.4	2.2	6.6	1.7	5.9	1.5	5.8	1.5
20	6.2	2.5	5.2	2.1	4.0	1.6	3.8	1.5
25	4.6	2.9	3.4	2.2	3.3	2.1	3.0	1.9
32	3	3.1	2.3	2.4	2.4	2.5	1.9	2.0
35	--	--	--	--	2.0	2.4	--	--
40	2.2	3.5	2.1	3.4	2.1	3.3	1.8	2.8
50	1.7	4.3	1.5	3.8	1.4	3.5	1.4	3.5
63	1.5	5.9	1.4	5.4	1.1	4.4	1.1	4.4
80	--	--	1.0	6.4	1.0	6.4	--	--
80	--	--	1.1	7.0	1.1	6.7	1.1	6.7
100	--	--	0.8	8.0	0.88	8	0.8	8
125	--	--	0.7	10.1	0.7	10.8	--	--

Correction factor for power loss

- Direct current and alternating current up to 60 Hz × 1.0
- Alternating current
 - 200 Hz × 1.1
 - 400 Hz × 1.15
 - 1000 Hz × 1.3

Configuration and dimensioning

Internal resistance R_i and power loss P_v the miniature circuit breaker compact range, 1+N in 1 MW, 5SY6 0
(data per pole with I_n)

I_n A	Characteristic B				Characteristic C			
	Phase-pole		N pole		Phase-pole		N pole	
	R_i mΩ	P_v mW	R_i mΩ	P_v mW	R_i mΩ	P_v mW	R_i mΩ	P_v mW
5SY6 0								
2	--	--	--	--	290	1161	3.8	15
4	--	--	--	--	110	1766	4.0	64
6	30	1092	4.2	150	26	931	4.3	154
8	--	--	--	--	19.8	1264	3.9	249
10	15	1539	4.1	407	13	1297	4.1	406
13	9.5	1598	4.1	692	9.1	1531	4.4	742
16	8.7	2219	4.0	1018	7.5	1926	3.3	852
20	5.2	2082	1.1	436	5.3	2118	1.2	478
25	3.3	2065	1.3	804	3.0	1906	1.1	674
32	2.6	2625	1.2	1192	2.7	2718	1.3	1310
40	2.3	3619	1.1	1789	2.2	3531	1.1	1820

Personnel safety with miniature circuit breakers

According to DIN VDE 0100-410, in order to protect against dangerous leakage currents in the TN system, the cross-sections of the conductor, or its distance from the protective device, must be dimensioned such that if a fault with negligible impedance (i. e. short circuit) occurs at any point between a phase conductor and a PE conductor, or a connected exposed conductive part, the device automatically trips within the specified times of 0.4 s/5 s.

This requirement is met through the following condition:

$$Z_s \times I_a \leq U_o$$

Z_s ≙ Impedance of the fault loop of all electrical circuits

I_a ≙ Current that trips within the specified times

U_o ≙ Voltage against ground

Maximum permissible impedance fault loop at $U_o = 230$ V AC for compliance with trip conditions according to DIN VDE 0100-410

I_n A	Characteristic A		Characteristic B		Characteristic C		Characteristic D	
	$t_a \leq 0.4$ s	≤ 5 s	$t_a \leq 0.4$ s	≤ 5 s	$t_a \leq 0.4$ s	≤ 5 s	$t_a \leq 0.4$ s	≤ 5 s
	Ω	Ω	Ω	Ω	Ω	Ω	Ω	Ω
5SL, 5SY, 5SP								
0.3	--	--	--	--	76.6	153	--	--
0.5	--	--	--	--	46	92	--	92
1.0	76.6	76.6	--	--	23	46	15.3	46
1.6	47.9	47.9	--	--	14.4	28.8	9.6	28.8
2	38.3	38.3	--	--	11.5	23	7.6	23
3	25.5	25.5	--	--	7.7	15.4	5.1	15.4
4	19.1	19.1	--	--	5.8	11.6	3.8	11.6
6	12.7	12.7	7.6	7.6	3.8	7.6	2.5	7.6
8	--	--	--	--	2.8	5.7	1.9	5.7
10	7.6	7.6	4.6	4.6	2.3	4.6	1.1	4.6
13	--	--	--	3.57	1.7	3.4	0.9	3.4
16	4.7	4.7	2.9	2.9	1.4	2.8	0.7	2.8
20	3.8	3.8	2.3	2.3	1.1	2.2	0.5	2.2
25	3.0	3.0	1.8	1.8	0.9	1.8	0.4	1.8
32	2.4	2.4	1.4	1.4	0.7	1.4	0.3	1.4
40	1.9	1.9	1.1	1.1	0.6	1.2	0.28	1.2
50	--	--	0.9	0.9	0.5	1.0	0.23	1.0
63	--	--	0.7	0.7	0.4	0.8	0.2	0.8
80	--	--	--	--	0.3	0.6	0.14	0.6
100	--	--	--	--	0.2	0.4	0.1	0.4
125	--	--	--	--	0.16	0.3	0.1	0.3

At $U_o = 240$ V AC, $Z_s \times 1.04$ applies.

At $U_o = 127$ V AC, $Z_s \times 0.55$ applies.

Miniature Circuit Breakers

Configuration and dimensioning

Fusing of luminaire circuits

Maximum permissible lamp load of a miniature circuit breaker when operating fluorescent lamps L 18 W, L 36 W, L 38 W, L 58 W.

Maximum number of fluorescent lamps

I_n [A]	Lamp	Electronic ballast											
		Full switching at 230 V 1-lamp ¹⁾			2 lamps			Group switching at 230 V 1-lamp ²⁾			2 lamps		
5SY4, 5SY7		B	C	D	B	C	D	B	C	D	B	C	D
6	L 18 W	17	37	66	17	35	35	66	66	66	35	35	35
	L 36 W	17	37	37	17	19	19	37	37	37	19	19	19
	L 58 W	17	19	19	12	12	12	19	19	19	12	12	12
8	L 18 W	--	50	88	--	47	47	--	88	88	--	--	47
	L 36 W	--	50	50	--	25	25	--	50	50	--	25	25
	L 58 W	--	25	25	--	16	16	--	25	25	--	16	16
10	L 18 W	36	67	111	36	58	58	111	111	111	58	58	58
	L 36 W	36	62	62	32	32	32	62	62	62	32	32	32
	L 58 W	32	32	32	20	20	20	32	32	32	20	20	20
13	L 18 W	44	81	144	44	76	76	144	144	144	76	76	76
	L 36 W	44	81	81	41	41	41	81	81	81	41	41	41
	L 58 W	41	41	41	26	26	26	41	41	41	26	26	26
16	L 18 W	56	100	177	56	94	94	177	177	177	94	94	94
	L 36 W	56	100	100	51	51	51	100	100	100	51	51	51
	L 58 W	51	51	51	32	32	32	51	51	51	32	32	32
20	L 18 W	70	117	222	70	117	117	222	222	222	117	117	117
	L 36 W	70	117	125	64	64	64	125	125	125	64	64	64
	L 58 W	64	64	64	40	40	40	64	64	64	40	40	40
25	L 18 W	85	157	277	85	147	147	277	277	277	147	147	147
	L 36 W	85	156	156	80	80	80	156	156	156	80	80	80
	L 58 W	80	80	80	51	51	51	80	80	80	51	51	51
32	L 18 W	100	144	355	100	144	188	355	355	355	188	188	188
	L 36 W	100	144	200	100	103	103	200	200	200	103	103	103
	L 58 W	100	103	103	65	65	65	103	103	103	65	65	65
40	L 18 W	126	216	444	126	216	235	444	444	444	235	235	235
	L 36 W	126	216	250	126	129	129	250	250	250	129	129	129
	L 58 W	126	129	129	81	81	81	129	129	129	81	81	81
50	L 18 W	180	247	555	180	247	294	555	555	555	294	294	294
	L 36 W	180	247	312	161	161	161	312	312	312	161	161	161
	L 58 W	161	161	161	102	102	102	161	161	161	102	102	102
63	L 18 W	170	340	567	170	340	370	700	700	700	370	370	370
	L 36 W	170	340	393	170	203	203	393	393	393	203	203	203
	L 58 W	170	203	203	128	128	128	203	203	203	128	128	128

¹⁾ All ECGs are turned on simultaneously.

²⁾ The ECGs are turned on in groups one after the other.

Circuit impedance:

The specified lamp loads apply, taking into account a line impedance of 800 mΩ.

At 400 mΩ, the permissible values are reduced by 10 %.

Reduction factors for miniature circuit breakers for the simultaneously switching on of incandescent lamp loads, taking into account the rated current of the miniature circuit breaker and the summated current of the lamps

	Reduction factor	
	Switching with miniature circuit breaker	Switching with separate switch breaker
5SL, 5SY, 5SP4		
Characteristic A	0.3	0.35
Characteristic B	0.5	0.6
Characteristic C	1	1
Characteristic D	1	1

Configuration and dimensioning

Current carrying capacity of miniature circuit breakers with corrected and uncorrected HQ, HQI and NAV lamps (number)

		Lamp power [W]							
		35	70	150	250	400	1000	2000	3500
Lamp current	[A]	0.5	1	1.8	3	3.5	9.5	10.3	18
Corrected lamp current	[A]	0.3	0.5	1	1.5	2	6	5.5	9.8
Inrush peak	[A]	10	18	36	60	70	120	125	220

		Lamp power [W]							
I_n [A]		35	70	150	250	400	1000	2000	3500
5SY4...-6, 5SY7...-6									
Characteristic B	6	2	1	0	0	0	0	0	0
	10	5	3	1	1	0	0	0	0
	13	7	4	2	1	1	0	0	0
	16	8	5	2	1	1	0	0	0
	20	11	6	3	1	1	1	1	0
	25	13	7	3	2	2	1	1	0
	32	16	8	4	2	2	1	1	0
	40	20	11	5	3	3	1	1	1
	50	28	15	7	4	4	2	2	1
	63	26	14	7	4	3	2	2	1
5SY4...-7, 5SY7...-7									
Characteristic C	6	6	3	1	1	0	0	0	0
	8	8	4	2	1	1	0	0	0
	10	10	6	3	1	1	0	0	0
	13	13	7	3	2	1	1	1	0
	16	16	9	4	2	2	1	1	0
	20	18	10	5	3	2	1	1	0
	25	25	14	7	4	3	2	1	1
	32	22	12	6	3	3	2	1	1
	40	33	18	9	5	4	2	2	1
	50	38	21	10	6	5	3	3	1
	63	53	29	14	9	7	4	4	2
5SY4...-8, 5SY7...-8									
Characteristic D	6	8	4	2	1	1	0	0	0
	8	11	5	3	2	1	0	0	0
	10	14	7	4	2	2	0	0	0
	13	18	9	5	3	2	1	1	0
	16	22	11	6	3	3	1	1	0
	20	28	14	7	4	4	1	1	0
	25	35	17	9	5	5	2	1	1
	32	44	22	12	7	6	2	2	1
	40	56	28	15	9	8	3	2	1
	50	70	35	19	11	10	4	3	2
	63	88	44	24	14	12	4	4	2
5SP4...-7									
Characteristic C	80	76	42	21	12	11	6	6/5	3
	100	98	54	27	16	14	8/7	8/6	4
	125	116	64	32	19	16	9	9/8	5
5SP4...-8									
Characteristic D	80	143/112	80/56	40/31	24/18	20/16	9/6	10/5	5/3
	100	186/140	103/70	51/39	31/23	26/20	11/7	12/6	7/4

Different data for corrected/uncorrected lamps.

Miniature Circuit Breakers

Configuration and dimensioning

Direct current, universal current

All 5SL, 5SY and 5SP4 miniature circuit breakers are suitable for use in direct current systems up to 60 V¹⁾ (1-pole) or 120 V 2-pole – series connection of two poles). The infeed can be from either the top or the bottom.

For higher voltages, you will require UC (UC = Universal Current) miniature circuit breakers from the 5SY5 and 5SP5 series, which can be used for both AC and DC applications.

The maximum voltage for DC per pole is 250 V. The series connection of individual poles enables 4-pole devices (for example) to be used for up to a maximum of 1000 V DC.

The arcing chamber area of the 5SY5 and 5SP5 miniature circuit breakers is equipped with an additional permanent magnet to support the positive quenching of the electric arc.

This is why the polarity of the switch is coded and it is essential to pay attention to the conduction direction when connecting the conductor. Suitable precautions should be taken during plant configuration to ensure there can be no polarity reversal in DC operation (e.g. photovoltaic plants).

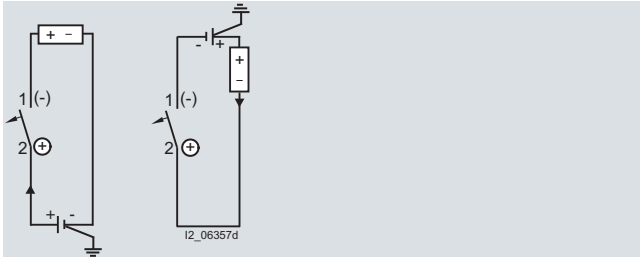

Miniature circuit breakers for single-pole tripping
Grounded system (left: - pole grounded, right: + pole grounded)
Rated voltage of miniature circuit breaker: 220 V

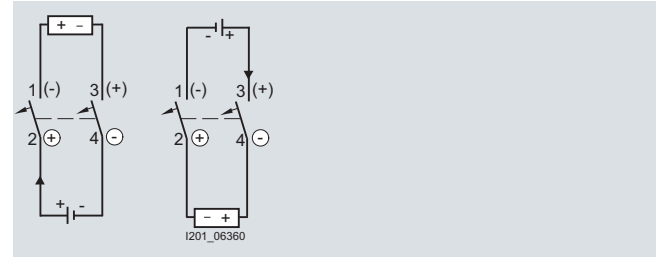

Miniature circuit breaker, two-pole for two-pole tripping
Non-grounded system (left: bottom infeed, right: top infeed)
Rated voltage of miniature circuit breaker: 220 V

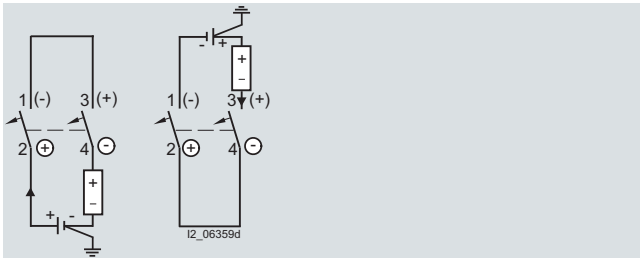

Miniature circuit breakers, two-pole for single-pole tripping
Grounded system (left: - pole grounded and bottom infeed, right: + pole grounded and top infeed)
Rated voltage of miniature circuit breaker: 440 V

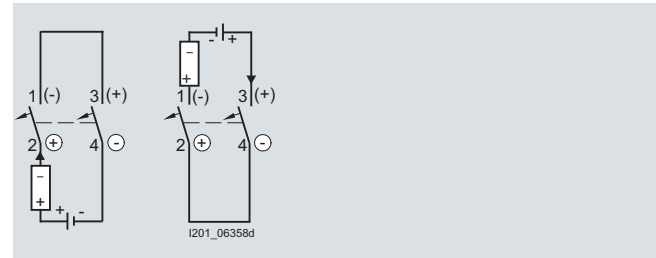

Miniature circuit breaker, two-pole for single-pole tripping
Non-grounded system (left: bottom infeed, right: top infeed)

Rated voltage of miniature circuit breaker: 440 V

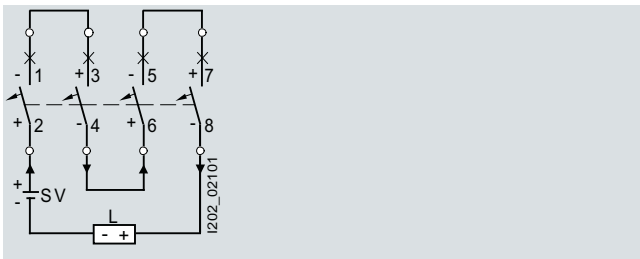

Miniature circuit breaker, four-pole for single-pole tripping
Non-grounded system (bottom infeed)
Rated voltage of miniature circuit breaker: 880 V

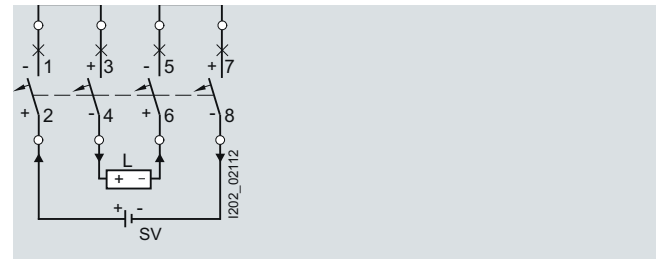

Miniature circuit breaker, four-pole for two-pole tripping
Non-grounded system (bottom infeed)
Rated voltage of miniature circuit breaker: 880 V

L: Load (e.g. shoot-through)

SV: Power supply unit (e.g. solar module, battery)

¹⁾ The operational voltage 60 V DC/pole takes into account a battery charging voltage with a peak value of 72 V.

Overview

UL standards are used in North America as well as in several other countries. This is of particular importance to European exporters of electrical switchgear equipment for machines who export to the USA, as their products will only be accepted if they meet the relevant UL standards.

A wide range of low-voltage circuit protection devices from Siemens comply with UL standards and are therefore suitable for implementation worldwide in both IEC/EN and UL applications within the framework of their specified use.

Miniature circuit breakers certified to UL 489 permit use as an all-round solution for protection tasks in distribution boards, control cabinets and control systems to UL 508A as "branch protectors". In particular, they are also approved for the protection of electrical circuits in heating, ventilating and cooling systems (HVAC), as well as for DC applications up to 60 V/125 V.

This covers a wide range of protection tasks, in residential and non-residential buildings, as well as in industry. The tripping characteristics B, C and D to EN/IEC 60898-1 have been adapted so that they fall in the permissible tripping range according to UL 489, as well as for applications at 25 °C and 40 °C.

This means that the devices are approved for use according to both standards. The enclosure dimensions of the devices correspond to DIN format. This means that the device series are suitable for universal use worldwide according to IEC or UL standards.

The key difference between the three device series is their application in different power supply systems.

- 5SJ4 ...-HG40: 240/120 V AC, 1-pole, "same polarity only",
- 5SJ4 ...-HG41: 240 V AC, 1-, 2- and 3-pole,
- 5SJ4 ...-HG42: 480Y/277 V AC, 1-, 2- and 3-pole.

The terminals are suitable for "field wiring". This means that the devices can be installed not only in factory-finished distribution boards and control cabinets, but also on-site in a customer system.

Using this mounting concept, all additional 5ST3 ...-HG components can be combined with miniature circuit breakers of the 5SJ4 ...-HG range. The auxiliary switch (AS) signals the contact position. In the event of a fault, the fault signal contact (FC) signals the automatic tripping of the MCB as well as the contact position. Shunt trips (ST) are used for the remote tripping of miniature circuit breakers. Captive metal brackets on the additional components ensure fast mounting on the devices.

Single-, two- and three-phase busbars in 3 lengths with 6, 12 or 18 pins are available as accessories for all device series. The in-feed is via connection terminals, which are available in two versions, for direct infeed at either the busbar or the miniature circuit breakers. Pins that are not required can be covered with touch protection covers.

Technical specifications

	5SJ4 ...-HG40	5SJ4 ...-HG41	5SJ4 ...-HG42
Standards	EN 60898-1; EN 60947-2; UL 489, UL-File E243414; CSA C22.2 No. 5-02		
Approvals	http://www.siemens.com/lowvoltage/support		
Tripping characteristic	B, C, D	C, D	
Operational voltage	Min. V AC/DC 24		
• Acc. to IEC 60898-1	Max. V DC/pole 60		
	Max. V AC 250/440		
• Acc. to UL 489 and CSA C22.2 No.5-02	Max. V AC 240/120	240	480Y/277
	DC V/1P 60	60	60
	DC V/2P --	125	125
Rated breaking capacity			
• I_{cn} acc. to IEC 60898-1	kA AC 10		
• I_{cu} acc. to IEC 60947-2	kA AC 15		
• Acc. to UL 489 and CSA C22.2 No.5-02	kA AC 14/10 ¹⁾	14/10 ¹⁾	10 ¹⁾
Insulation coordination			
• Rated insulation voltage	V AC 250	250/440	
• Pollution degree for overvoltage category	3/III		
Touch protection acc. to EN 50274	Yes		
Handle end position, sealable	Yes		
Degree of protection acc. to EN 60529	IP20, with connected conductors		
CFC and silicone-free	Yes		
Mounting	On standard mounting rail		
Terminals			
• Combined terminals at both ends		Yes	
• Terminal tightening torque, only for Cu, 60/75 °C	Nm 3.5		
	lb. in 31		
Conductor cross-sections			
• Solid and stranded, acc. to UL 489 and CSA C22.2 No.5-02	AWG 14 ... 4		
• Solid and stranded, acc. to IEC 60898-1	mm ² 0.75 ... 35		
• Finely stranded, with end sleeve	mm ² 0.75 ... 25		
Mains connection	Any		
Mounting position	Any		
Service life, on average, with rated load	20000 actuations		
EMC environment			
• Acc. to EN 60947-2	Suitable for environment "B" (immunity to interference not applicable)		
Ambient temperature	°C -25 ... +45, occasionally +55, max. 95 % humidity, storage temperature: -40 ... +75		
Resistance to climate acc. to IEC 60068-2-30	6 cycles		
Resistance to vibrations acc. to IEC 60068-2-6	m/s ² 50 at 25 ... 150 Hz and 60 at 35 Hz (4 sec)		

¹⁾ For detailed information on rated switching capacity, see page 53.

Miniature Circuit Breakers

Miniature circuit breakers 5SJ4 . . . - . HG and accessories, according to UL 489 and IEC

Additional components		Auxiliary switches (AS)	Fault signal contacts (FC)	Shunt trips (ST)	
		5ST3 010-0HG 5ST3 011-0HG 5ST3 012-0HG	5ST3 020-0HG 5ST3 021-0HG 5ST3 022-0HG	5ST3 030-0HG	5ST3 031-0HG
Standards		UL 489, UL-File E243414; CSA 22.2 No. 5-02 IEC/EN 62019, IEC/EN 60947-5-1		IEC/EN 60947-1	
Operational voltage/operational current (load)					
• Acc. to IEC	V AC	400	230	110 ... 415	24 ... 60
	A AC	2	6 (NC: AC13, S: AC14)		--
	V DC	220	110	60	24 ... 60
	A DC	1	1	3	6 (DC13)
• Acc. to UL	V AC	480	277	240	120
	A AC	1.5	3	4	6
	V DC	125	60		
	A DC	1	3		
Short-circuit protection		Miniature circuit breaker or 6 A fuse			
Minimum contact load		50 mA, 24 V			
Tripping operations		--	--	max. 2000	
Service life, on average, with rated load		12000 actuations			
Primary operating range		x U_n	--	0.7 ... 1.1	
Conductor cross-sections		AWG mm ²	22 ... 14 0.5 ... 2.5	22 ... 14 0.5 ... 2.5	
Terminals					
• Terminal tightening torque	Nm	0.5		0.8	
	lb/in	4.5		6.8	
Version		Busbars		Terminals	
Type		5ST3 663-.HG 5ST3 664-.HG 5ST3 665-.HG		5ST3 666-0HG	5ST3 666-2HG
Standards		UL 489; UL File No. E243414			
Operational voltage					
• Acc. to IEC • Acc. to UL 489	V AC	690			
	V AC	480Y/277 and 240			
Rated conditional short-circuit current		kA	15 (with NH3 355A gL/gG 500 V)		
• Dielectric strength • Surge strength	kV/mm	30			
	kV	> 9.5			
Rated current at 40 °C ambient temperature		A	115		
Insulation coordination					
• Pollution degree • Overvoltage category			2		
			III		
Busbar cross-section (Cu)		mm ²	16		
Infeed		Any			
Conductor cross-sections					
• AWG cables • Solid and stranded	AWG	--	14 ... 2	14 ... 1	
	mm ²	--	1.5 ... 35	1.5 ... 50	
Terminals					
• Terminal tightening torque	Nm	--	3.3	3.3	
	lb. in	--	30	30	
Temperature resistance		°C	200 – UL 94-V0/0.4 mm		

Characteristic curves

Tripping characteristics acc. to IEC/EN 60898-1 and UL 489/CSA 22.2 No.5-02

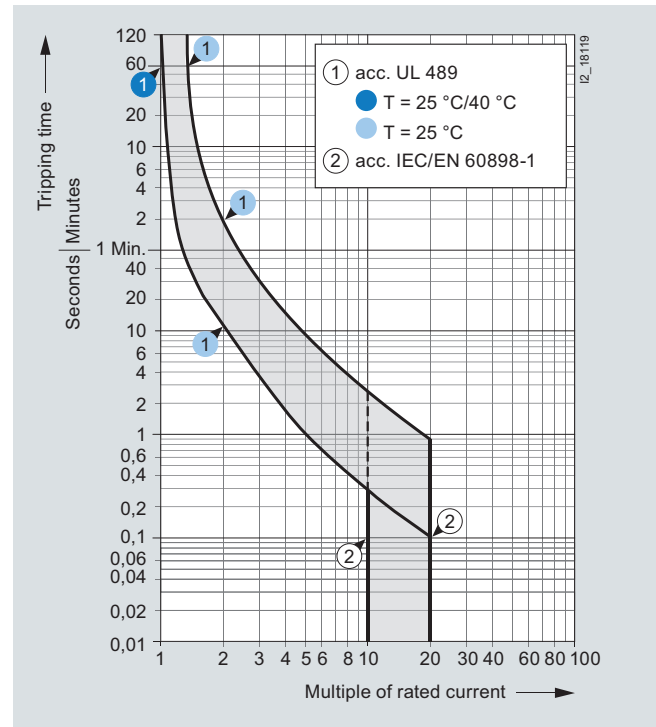
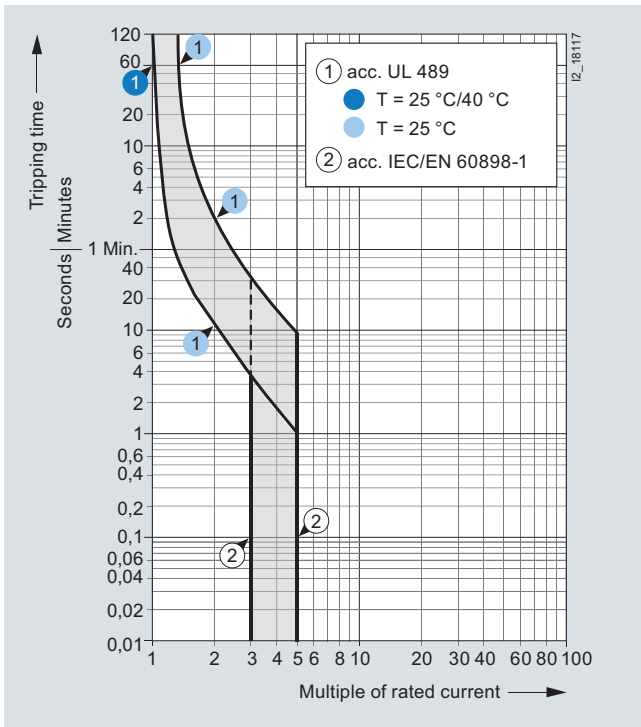

Tripping characteristic B

MCBs with this tripping characteristic are designed for universal use in socket outlet and lighting circuits. Proof of personal safety acc. to DIN VDE 0100-410 is not required.

Tripping characteristic D

For electrical circuits with strong pulse-generating equipment, such as transformers or solenoid valves.

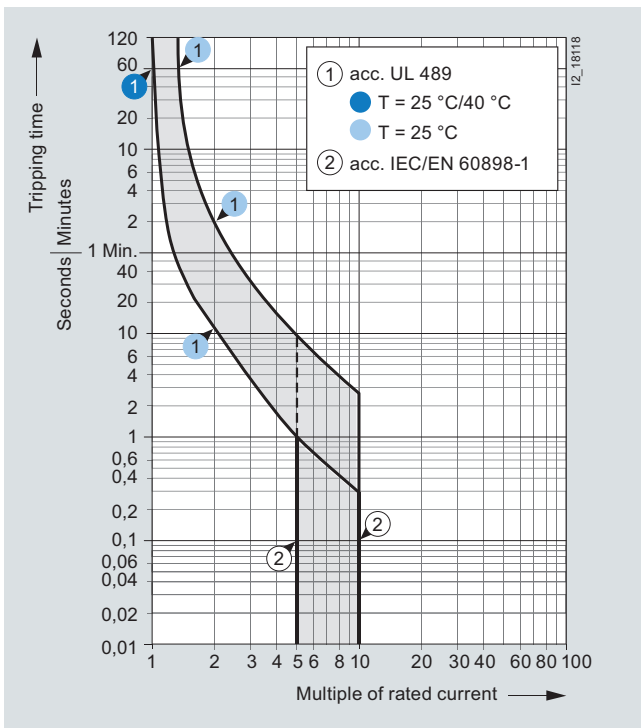

Tripping characteristic C

Primarily used in lamp and motor circuits with higher starting currents.

Correction factors for rated current at different ambient temperatures

Dependence of the permissible continuous load on ambient temperature

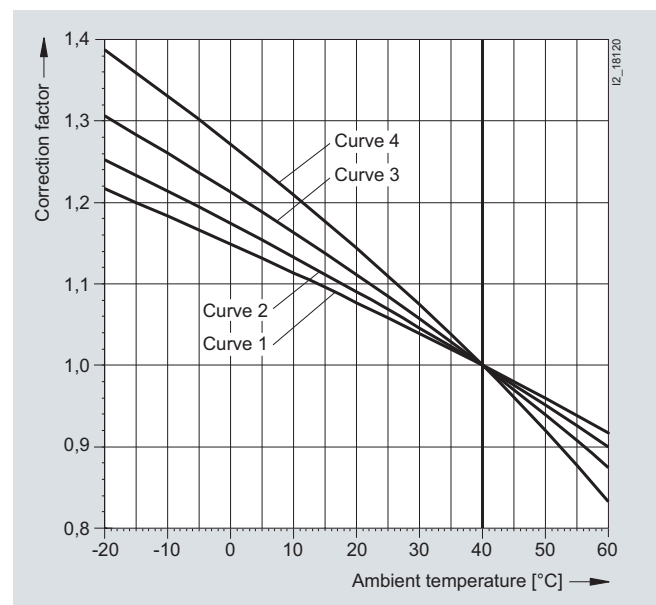

Miniature Circuit Breakers

Miniature circuit breakers 5SJ4 . . . - .HG and accessories, according to UL 489 and IEC

Correction factor for 5SJ4 . . . - .HG miniature circuit breakers
(for curves, see diagram on previous page)

Rated current (A)	0.3	0.5	1	1.6	2	3	4	5	6	8	10	13	15	16	20	25	30	32	35	40	45	50	60	63
Number of poles	Valid curves for correction factor for 5SJ4 . . . - .HG miniature circuit breakers																							
1	4	4	4	4	3	3	2	2	2	2	3	3	3	3	3	3	3	3	3	3	2	2	3	2
2	4	4	3	3	3	3	2	2	2	2	3	3	3	2	2	2	2	2	2	2	1	2	2	1
3	4	4	3	3	3	3	2	2	2	2	3	3	3	2	2	2	2	2	2	2	1	1	1	1

Current carrying capacity at ambient temperatures other than 40 °C

In the event of ambient temperatures other than 40 °C, refer to the following table for the current carrying capacity of the 5SJ4 . . . - .HG miniature circuit breakers.

Rated current I_n (A) at 40 °C		Permissible rated current I_n (A), depending on the ambient temperature						
Rated current I_n (A)	Number of poles	15 °C	20 °C	25 °C	30 °C	40 °C	50 °C	55 °C
0.3	1/2/3	0.35	0.34	0.33	0.32	0.30	0.28	0.26
0.5	1/2/3	0.59	0.57	0.55	0.54	0.50	0.46	0.44
1	1	1.2	1.1	1.1	1.1	1.0	0.9	0.9
	2/3	1.1	1.1	1.1	1.1	1.0	0.9	0.9
1.6	1	1.9	1.8	1.8	1.7	1.6	1.5	1.4
	2/3	1.8	1.8	1.7	1.7	1.6	1.5	1.5
2	1/2/3	2.3	2.2	2.2	2.1	2.0	1.9	1.8
3	1/2/3	3.4	3.3	3.3	3.2	3.0	2.8	2.7
4	1/2/3	4.5	4.4	4.3	4.2	4.0	3.8	3.7
5	1/2/3	5.6	5.5	5.3	5.2	5.0	4.8	4.6
6	1/2/3	6.7	6.5	6.4	6.3	6.0	5.7	5.6
8	1/2/3	8.9	8.7	8.6	8.4	8.0	7.6	7.4
10	1/2/3	11.4	11.1	10.8	10.6	10.0	9.4	9.1
13	1/2/3	14.8	14.4	14.1	13.7	13.0	12.2	11.8
15	1/2/3	17.1	16.7	16.3	15.9	15.0	14.1	13.6
16	1	18.2	17.8	17.4	16.9	16.0	15.0	14.5
	2/3	17.8	17.5	17.1	16.7	16.0	15.2	14.8
20	1	22.8	22.2	21.7	21.1	20.0	18.8	18.1
	2/3	22.3	21.8	21.4	20.9	20.0	19.0	18.5
25	1	28.4	27.8	27.1	26.4	25.0	23.5	22.7
	2/3	27.8	27.3	26.7	26.2	25.0	23.8	23.1
30	1	34.1	33.3	32.5	31.7	30.0	28.2	27.2
	2/3	33.4	32.7	32.1	31.4	30.0	28.5	27.8
32	1	36.4	35.6	34.7	33.8	32.0	30.1	29.0
	2/3	35.6	34.9	34.2	33.5	32.0	30.4	29.6
35	1	39.8	38.9	38.0	37.0	35.0	32.9	31.8
	2/3	38.9	38.2	37.4	36.6	35.0	33.3	32.4
40	1	45.5	44.5	43.4	42.3	40.0	37.6	36.3
	2/3	44.5	43.6	42.8	41.9	40.0	38.0	37.0
45	1	50.1	49.1	48.1	47.1	45.0	42.8	41.7
	2/3	49.3	48.5	47.6	46.8	45.0	43.2	42.2
50	1/2	55.6	54.6	53.5	52.3	50.0	47.6	46.3
	3	54.8	53.9	52.9	52.0	50.0	48.0	46.9
60	1	68.3	66.7	65.1	63.4	60.0	56.4	54.4
	2	66.8	65.5	64.1	62.8	60.0	57.1	55.5
	3	65.7	64.6	63.5	62.4	60.0	57.5	56.3
63	1	70.1	68.7	67.3	65.9	63.0	59.9	58.3
	2/3	69.0	67.9	66.7	65.5	63.0	60.4	59.1

Miniature Circuit Breakers

Miniature circuit breakers 5SJ4 . . . - .HG and accessories, according to UL 489 and IEC

Let-through I^2t values 5SJ4...-HG

Characteristic B

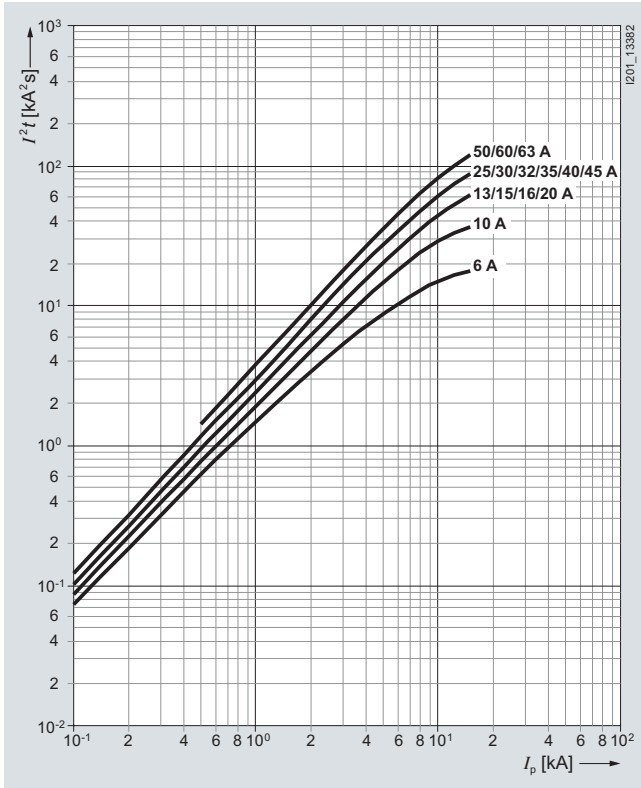

Characteristic D

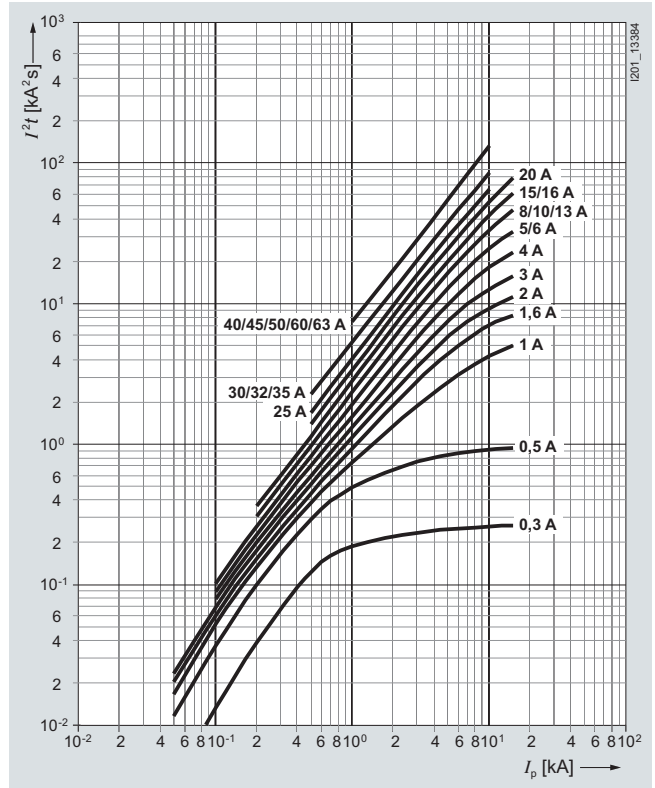

Characteristic C

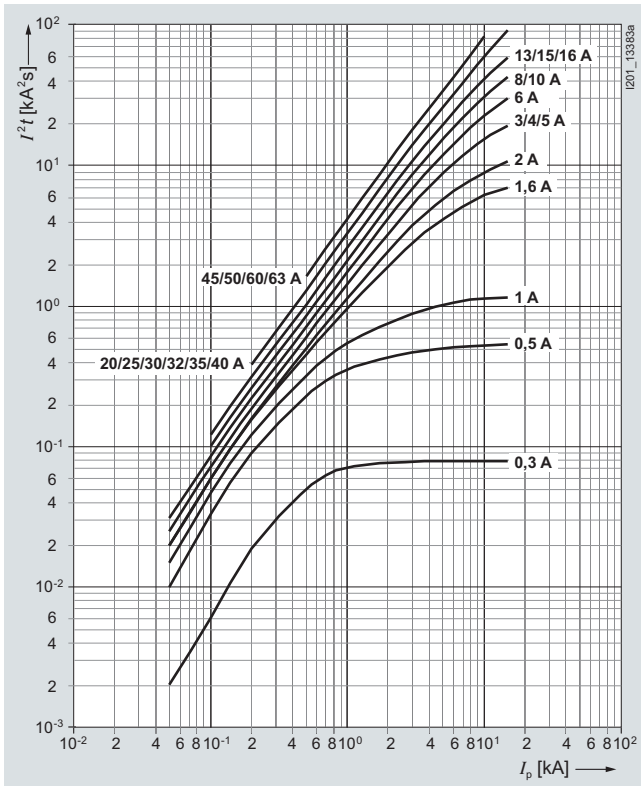

Miniature Circuit Breakers

Miniature circuit breakers 5SJ4 . . . - HG and accessories, according to UL 489 and IEC

Dimensional drawings

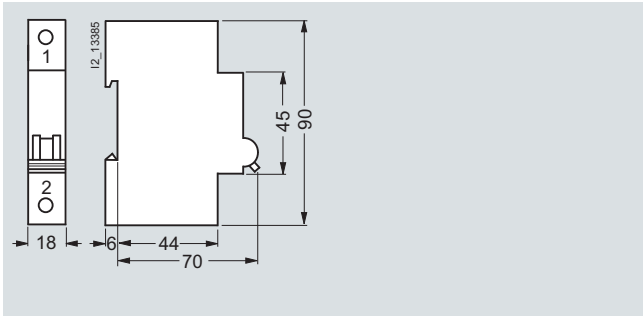

5SJ4 ...-HG40

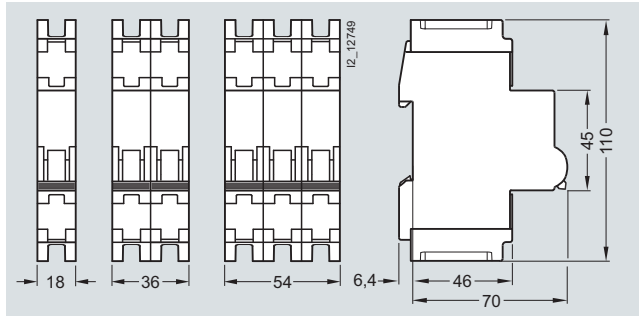

5SJ4 ...-HG41

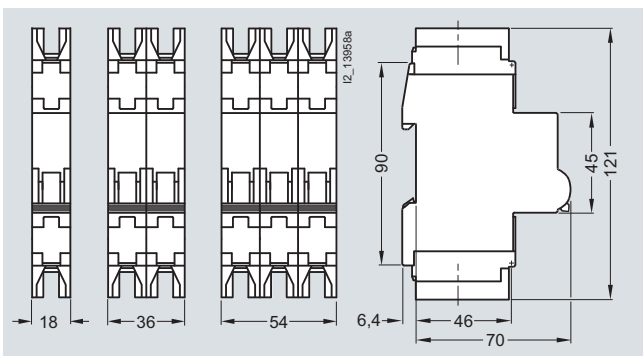

5SJ4 ...-HG42

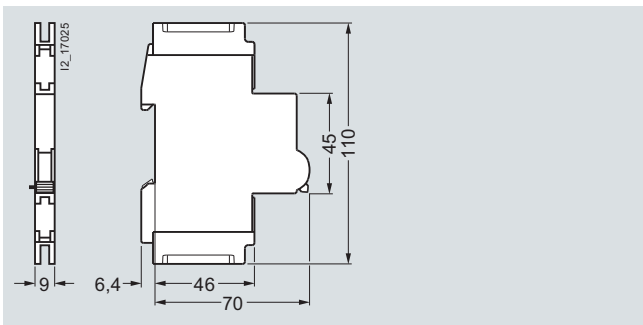

5ST3 010-0HG 5ST3 011-0HG 5ST3 012-0HG
5ST3 020-0HG 5ST3 021-0HG 5ST3 022-0HG

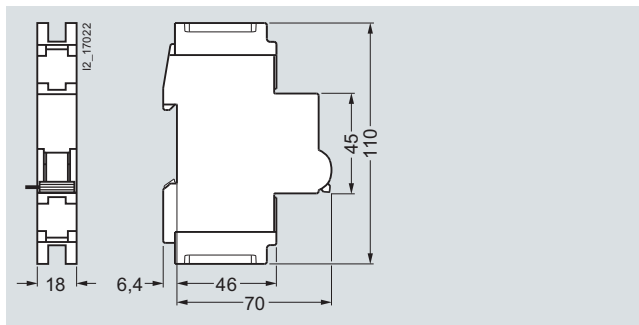

5ST3 030-0HG 5ST3 031-0HG

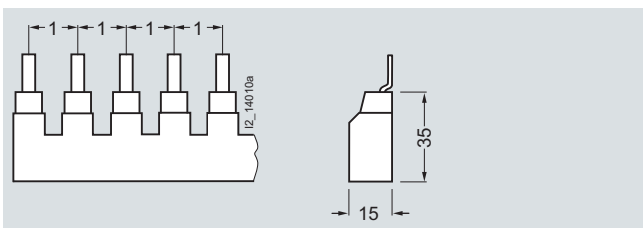

5ST3 663-0HG 5ST3 664-0HG 5ST3 665-0HG
5ST3 663-1HG 5ST3 664-1HG 5ST3 665-1HG
5ST3 663-2HG 5ST3 664-2HG 5ST3 665-2HG

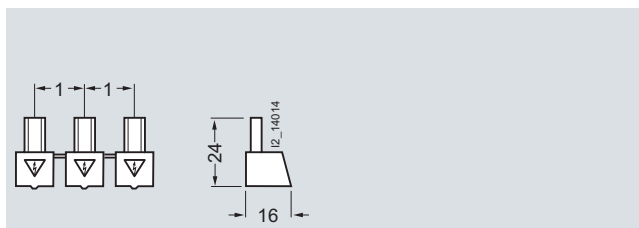

5ST3 666-1HG

Note:

Pin spacing in MW
Dimensions of side views in mm (approx.)

Note:

Pin spacing in MW
Dimensions of side views in mm (approx.)

Miniature Circuit Breakers

Miniature circuit breakers 5SJ4 . . . - HG and accessories, according to UL 489 and IEC

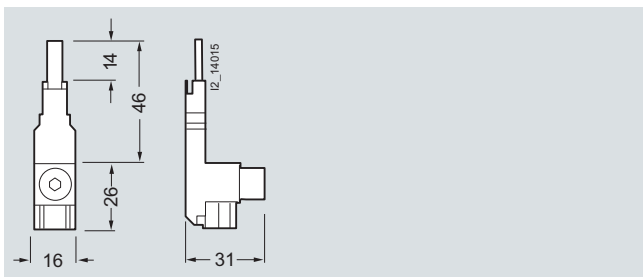

5ST3 666-0HG

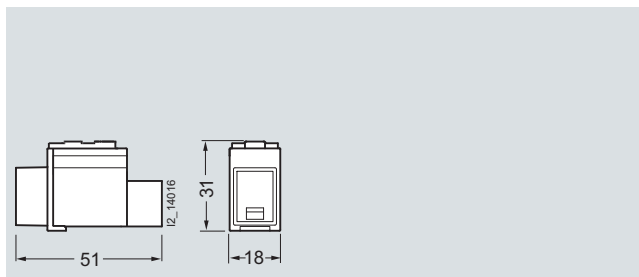

5ST3 666-2HG

Schematics

Diagrams

Miniature circuit breakers

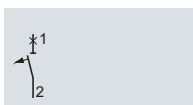

5SJ4 . . . -HG
1P

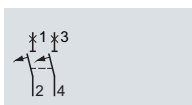

2P

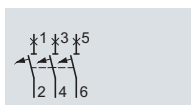

3P

Additional components

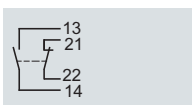

Auxiliary switches (AS)
5ST3 010-0HG

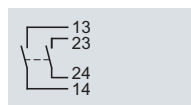

5ST3 011-0HG

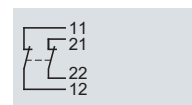

5ST3 012-0HG

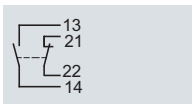

Fault signal contacts (FC)
5ST3 020-0HG

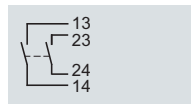

5ST3 021-0HG

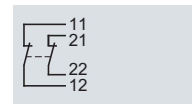

5ST3 022-0HG

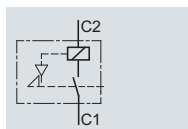

Shunt trips (ST)
5ST3 030-0HG
5ST3 031-0HG

More information

Rated switching capacity according to UL 489

Designation	Characteristic	Current A	Rated switching capacity (operational voltage 240 V AC) kA AC	
			Rated switching capacity (operational voltage 240 V AC) kA AC	Rated switching capacity (operational voltage 480Y/277 V AC) kA AC
5SJ4 . . . -HG40	B	6 ... 63	14	--
	C	0.3 ... 40	14	--
	C	45 ... 63	10	--
	D	0.3 ... 20	14	--
	D	25 ... 63	10	--
5SJ4 . . . -HG41	C	0.3 ... 40	14	--
	C	45 ... 63	10	--
	D	0.3 ... 20	14	--
	D	25 ... 63	10	--
5SJ4 . . . -HG42	C	0.3 ... 40	14	10
	D	0.3 ... 20	14	10
	D	25 ... 32	10	10

Miniature Circuit Breakers

Miniature circuit breakers 5SJ4 ... - .HG and accessories, according to UL 489 and IEC

Internal resistance and power loss per pole at I_n

Rated current I_n A	Characteristic B		Characteristic C		Characteristic D	
	R_i mΩ	P_V W	R_i mΩ	P_V W	R_i mΩ	P_V W
0.3	--	--	12900	1.2	12600	1.1
0.5	--	--	4900	1.2	4600	1.2
1	--	--	1650	1.7	1480	1.5
1.6	--	--	620	1.6	570	1.5
2	--	--	440	1.8	435	1.8
3	--	--	197	1.8	190	1.7
4	--	--	115	1.8	100	1.6
5	--	--	115	2.9	100	2.5
6	85	3.1	74	2.7	73	2.6
8	--	--	40	2.6	39	2.5
10	16.5	1.7	13.5	1.4	11.9	1.2
13	11.7	2.0	10.2	1.7	10.2	1.7
15	8.5	1.9	7.8	1.8	7.7	1.7
16	8.5	2.2	7.8	2.0	7.7	2.0
20	6.7	2.7	5.5	2.2	5.5	2.2
25	4.3	2.7	4.2	2.6	4.2	2.6
30	3.4	3.1	3.5	3.2	3.0	2.7
32	3.4	3.5	3.5	3.6	3.0	3.1
35	2.8	3.4	2.8	3.4	2.7	3.3
40	2.8	4.5	2.8	4.5	2.5	4.0
45	2.8	5.7	2.7	5.5	2.5	5.1
50	2.1	5.3	2.1	5.0	2.0	5.0
60	1.7	6.1	1.7	6.1	1.7	6.1
63	1.7	6.7	1.7	6.7	1.7	6.7

Mounting concept for mounting 5ST3 0...0HG accessories on 5SJ4 ... - .HG miniature circuit breakers

The diagram shows which additional components can be mounted on the right.

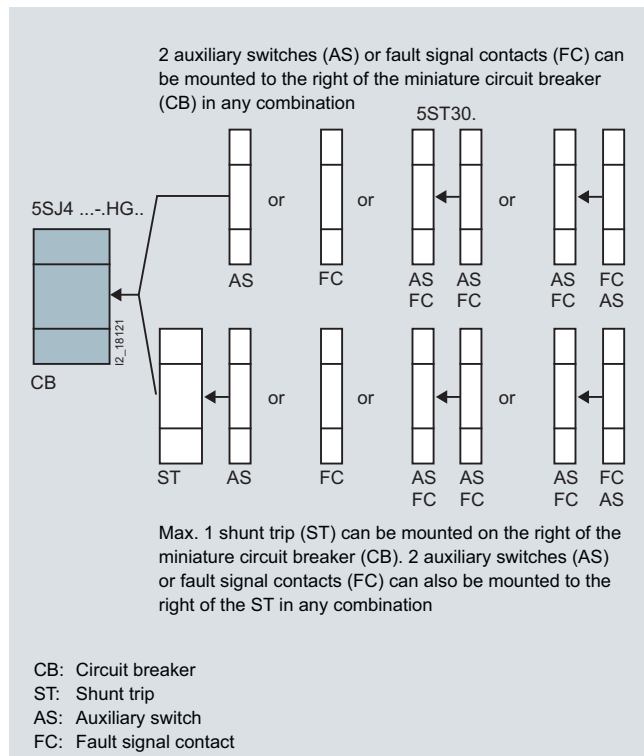

SHU 5SP3 main miniature circuit breakers

Overview

Selective main miniature circuit breakers are used as circuit breakers at meter panels and provide an optimum solution.

Characteristic E is adapted to the special application requirements for cascade circuits between melting fuses and miniature circuit breakers in distributor circuits.

An integrated adapter enables quick and easy mounting of the devices on 40-mm busbars. The reduced width of 1.5 MW

creates lots of additional space in the meter cabinet. The screwless outgoing terminal provides optimum user-friendliness.

Used in conjunction with the downstream miniature circuit breaker, selective main miniature circuit breakers ensure effective protection and optimum availability of the system.

Technical specifications

		5SP3 7..., 5SP3 7...-1	5SP3 7...-2, 5SP3 7...-2KK0.	5SP3 8...-2
Standards		DIN VDE 0645	E DIN VDE 0641-21	
Rated voltage U_n				
• 1-pole	V AC	230/400		--
• 3 x 1-pole	V AC	400	--	400
Operational voltage		Min.	V AC	110
	Max.	V AC	440	
Rated frequency		Hz	50 ... 60	
Rated current I_n		A	16 ... 100	16 ... 63
Rated insulation voltage U_i		V AC	690	
Rated switching capacity I_{cn}		A	25000	
Insulation coordination				
• Overvoltage category			IV	
• Pollution degree			3	
Surge strength U_{imp}		kV	6	
Impact resistance			30 g, at least 3 impacts, impact duration 11 ms	
Resistance to vibrations			2 g, 20 frequency cycles 5 ... 150 ... 15 Hz	
Switching position indication			OFF = green, ON = red	
Main conductor characteristics		Acc. to EN 60204-1	Yes	
Handle end position, sealable			Yes	
Cutoff		ON/OFF	--	Locking slide with lock, additional wire seal, cable ties and Antilux
Device depth		mm	92	
Degree of protection			IP20, with connected conductors	
Mains connection			Any	
Mounting position			Any	
Mounting			On standard mounting rail or interface adapter	Direct tool-free mounting on the busbar system
Service life, on average, with rated load		Actuations	20000	
Conductor connections			Saddle terminals at both ends	
• Top				Screwless spring terminal for flexible cables, in particular for meter connecting cables acc. to DIN 43870-3
• Bottom				Box terminal, also for infeed of the busbar system, up to 100 A input terminal current
Conductor cross-sections				
• Top and bottom, solid and stranded	mm ²	2.5 ... 70	--	
• Top and bottom, finely stranded	mm ²	2.5 ... 50	--	
• Top, finely stranded	mm ²	--	2.5 ... 16	
• Bottom, solid, stranded and finely stranded, with end sleeve	mm ²	--	2.5 ... 50	
Storage temperature		°C	-40 ... +70	
Ambient temperature		°C	-25 ... +55	

Miniature Circuit Breakers

SHU 5SP3 main miniature circuit breakers

Configuration

Internal resistance and power loss

- Internal resistance per pole in mΩ cold state
- Power loss per pole in W for rated current

Type	Rated current A	R_i mΩ	P_{max} W
5SP3 7...-2, 5SP3 7...-2KK0., 5SP3 8...-2	16	15.3	4.5
	20	11.3	6.0
	25	8.7	6.5
	35	4.5	6.9
	40	3.8	6.4
	50	3.5	8.0
5SP3 7...-1, 5SP3 7...-1	63	2.3	9.7
	16	15.5	5.2
	20	12.5	6.5
	25	7.4	6.5
	32	5.3	7.2
	35	4.0	7.6
	40	4.0	8.0
	50	2.9	9.5
	63	2.0	9.9
	80	1.5	13.5
100	1.0	14.4	

Selectivity

Due to its principle of action, the selective main miniature circuit breaker is always selective up to the rated switching capacity of the downstream miniature circuit breaker, e.g. 6000 A or 10000 A.

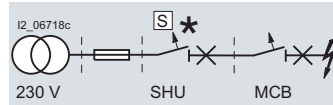

In a cascade circuit with melting fuses, selective main miniature circuit breakers and miniature circuit breakers, the following values apply for the melting fuses:

SHU A	6000 3 A	MCB gG			
		63 A	80 A	100 A	125 A
35	≤ 6	10	10	10	10
	8 ... 10	7	10	10	10
	13 ... 16	6	9	10	10
	20	5	8	10	10
40	≤ 6	10	10	10	10
	8 ... 10	6	10	10	10
	13 ... 16	6	8	10	10
	20	5	7	10	10
50	≤ 6	10	10	10	10
	8 ... 10	6	10	10	10
	13 ... 16	6	8	10	10
	20	4.5	7	10	10
63	≤ 6	10	10	10	10
	8 ... 10	5	8	10	10
	13 ... 16	5	7	10	10
	20	4.5	6.5	10	10
25	4	6	10	10	

Characteristic curves

Characteristic E acc. to E DIN VDE 0641-21

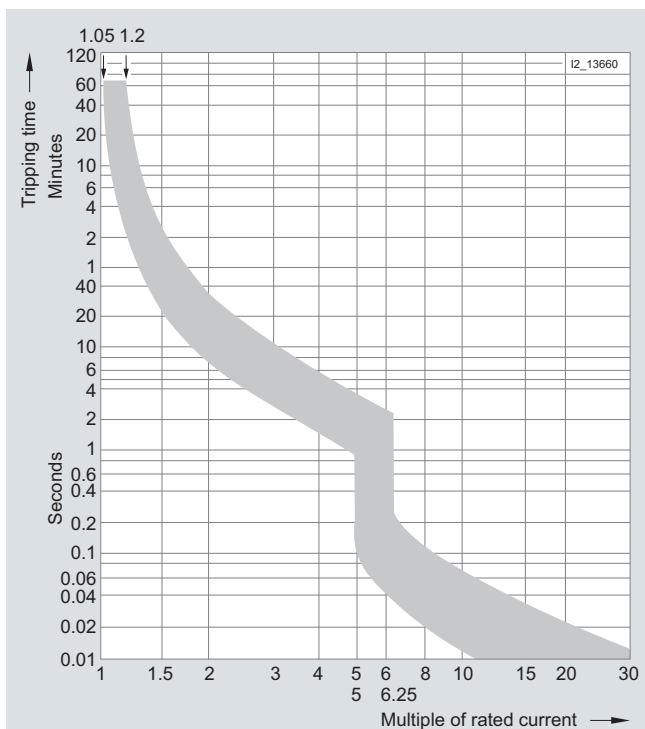

Miniature Circuit Breakers

SHU 5SP3 main miniature circuit breakers

Let-through current

5SP3 7... , 5SP3 7...-1

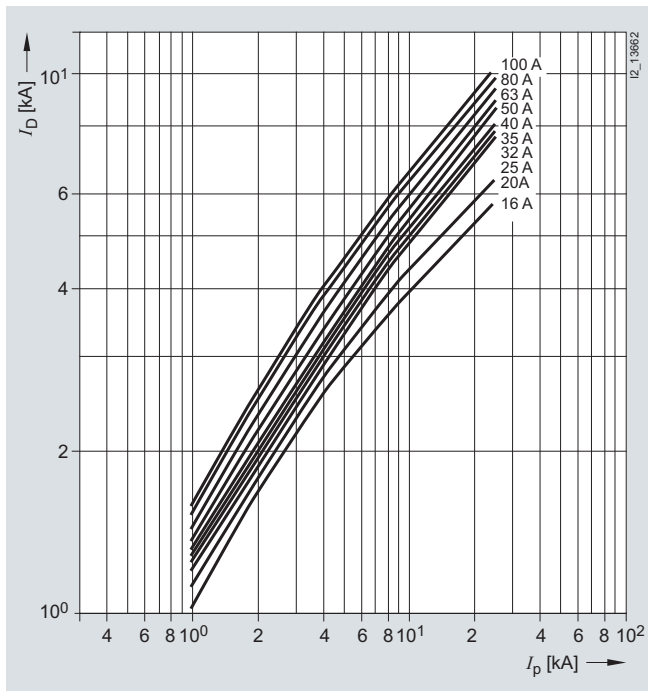

5SP3 7...-2, 5SP3 7...-2KK0., 5SP3 8...-2

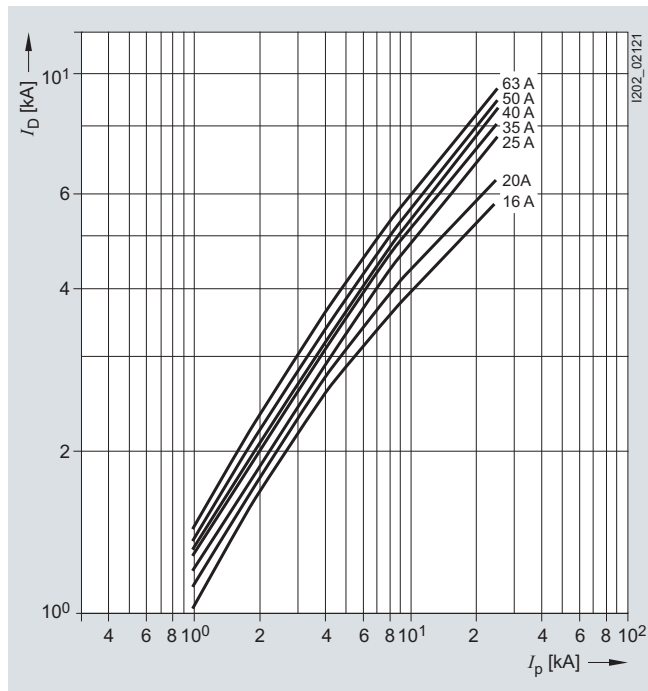

Let-through I^2t values

5SP3 7... , 5SP3 7...-1

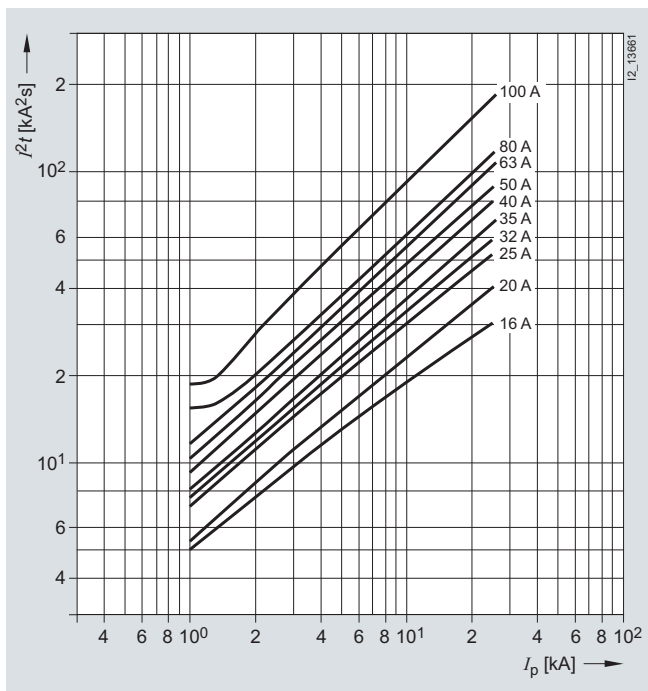

5SP3 7...-2, 5SP3 7...-2KK0., 5SP3 8...-2

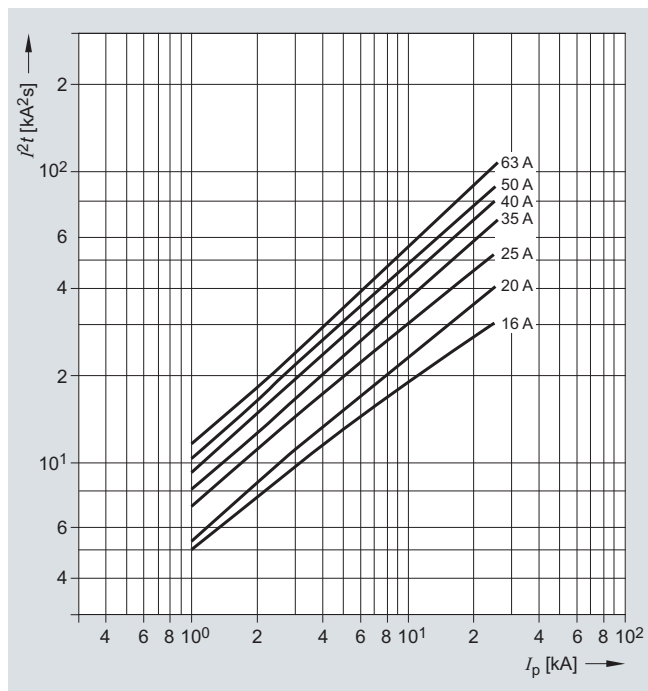

Miniature Circuit Breakers

SHU 5SP3 main miniature circuit breakers

Dimensional drawings

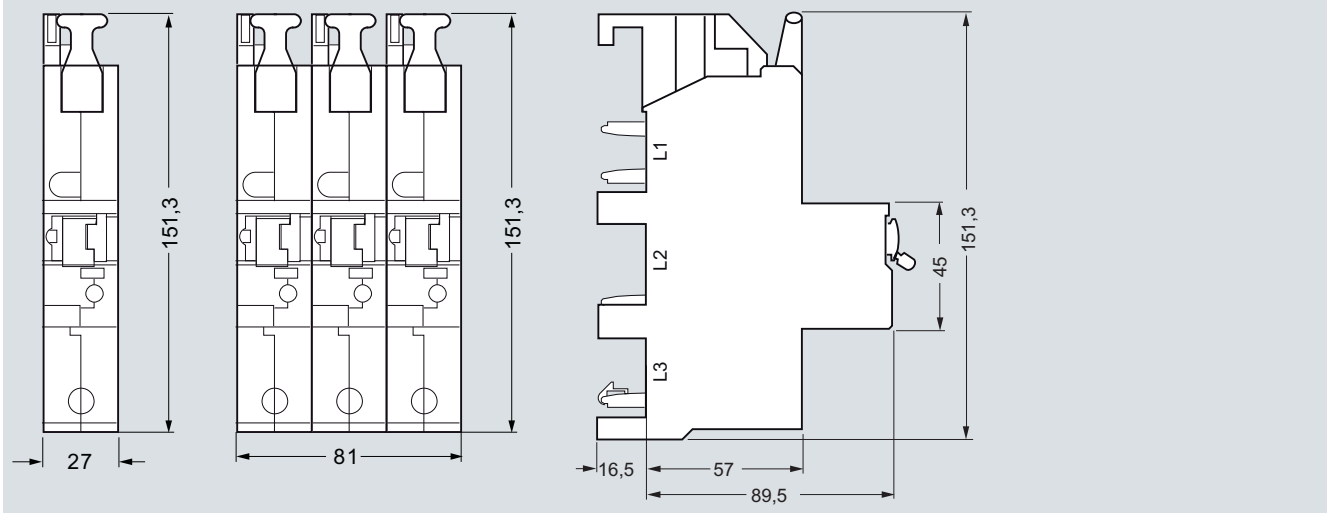

5SP3 7...-2
5SP3 7...-2KK0.
1P
5SP3 8...-2
3 x 1P

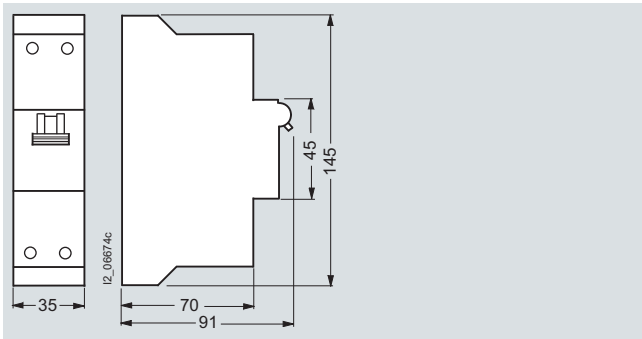

5SP3 7..., 5SP3 7...-1

Schematics

Diagrams

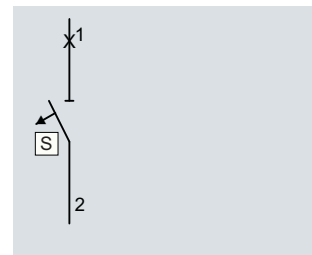

5SP3 7...
5SP3 7...-1
5SP3 7...-2
5SP3 7...-2KK0.
1P

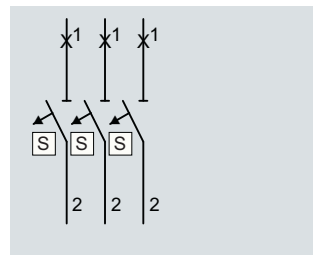

5SP3 8...-2
3 x 1P

Miniature Circuit Breakers

Circuit breaker terminals



5SK9 circuit breaker terminals

Overview

Circuit breaker terminals are used for short-circuit protection or for protection against overloading and short-circuiting in auxiliary and control circuits after control transformers. All terminals

are designed for 2 wires. The terminal block labeling accessories are used for inscription.

Technical specifications

		5SK9 011-1KK2., 5SK9 011-2KK2.	5SK9 011-4KK2., 5SK9 011-6KK2., 5SK9 011-8KK2.
Standards		DIN VDE 0660-101, IEC/EN 60947-2, UL 1077	
Rated operational voltage	Max.	AC DC	250 V at 50/60 Hz 60 V
Operational voltage	Min.	V AC/DC	24
Power loss	Max.	W	1
Rated impulse withstand voltage		kV	4
Pollution degree	Acc. to EN 60664-1		3
Rated current of through-type connection		A	16
Rated operational current of auxiliary switch		A	1
Mechanical service life		Actuations	16000
Electrical service life , on average, with rated load		Actuations	8000
Polarity with direct current			Any
Mounting position			Any
Resistance to vibrations			10 g at ≤ 70 Hz
Enclosures			With thermoplastic insulating body Screw connection at both ends for 2 conductors each Enclosed on both sides
Touch protection	Acc. to EN 50274-1		Yes
Terminal size		mm ²	1.5 2.5
Terminal tightening torque , recommended		Nm	0.8
Conductor cross-sections			
• Solid		mm ²	1 or 2 × (0.75 ... 1.5)
• Finely stranded, with end sleeve		mm ²	1 or 2 × (1 ... 2.5)
•  AWG 14-12			Yes --
•  AWG 14			Yes --
Stripped length		mm	10

Miniature Circuit Breakers

Circuit breaker terminals

5SK9 circuit breaker terminals

Characteristic curves

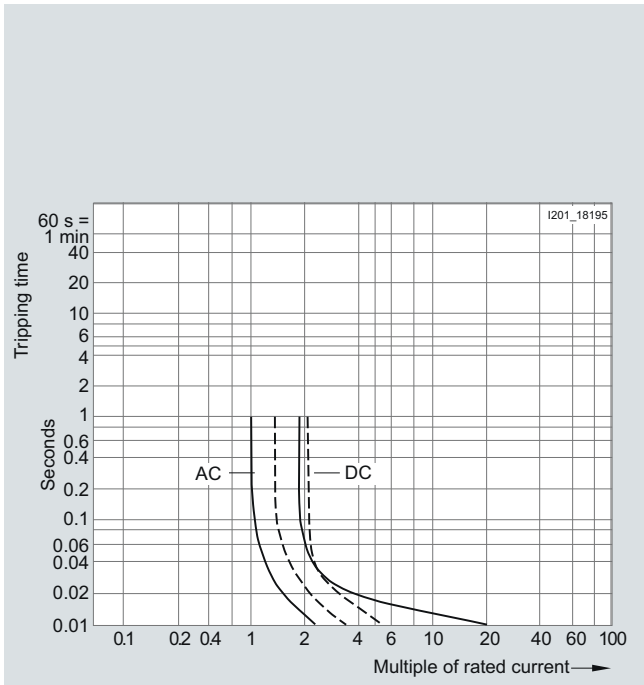

Tripping characteristic of short-circuit releases

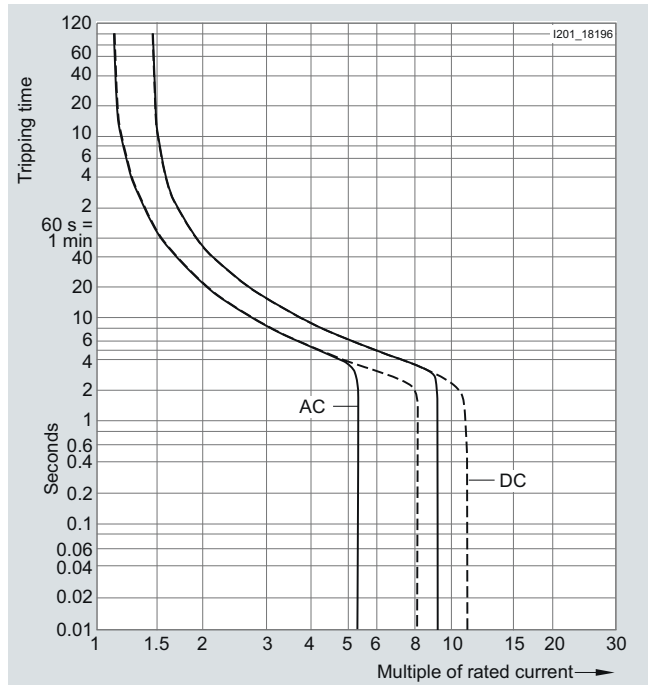

Tripping characteristics of combined overload and short-circuit releases

Dimensional drawings

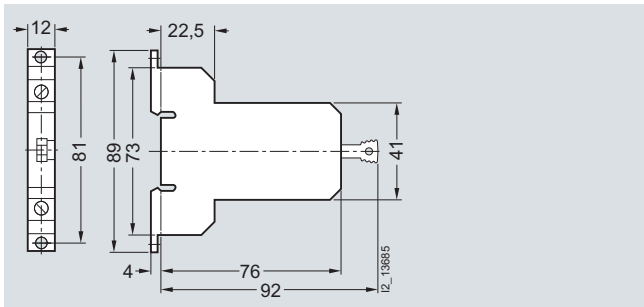

5SK9 011-1KK2.
5SK9 011-2KK2.

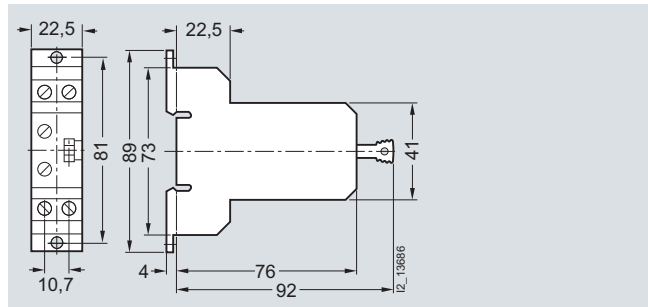

5SK9 011-4KK2.
5SK9 011-6KK2.
5SK9 011-8KK2.

Schematics

Diagrams



5SK9 011-1KK2.

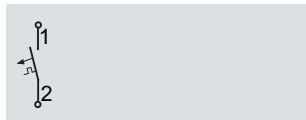

5SK9 011-2KK2.

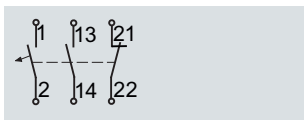

5SK9 011-6KK2.

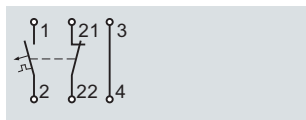

5SK9 011-4KK2.

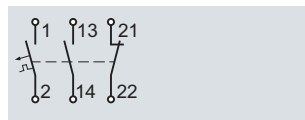

5SK9 011-8KK2.

Siemens AG
Industry Sector
Building Technologies Division
Low Voltage Distribution
Postfach 10 09 53
93009 REGENSBURG
GERMANY

www.siemens.com/lowvoltage

Subject to change without prior notice
PDF only
3P.8303.54.27
PH 0611 58 En
© Siemens AG 2011

The information provided in this configuration Manual contains descriptions or characteristics of performance which in case of actual use do not always apply as described or which may change as a result of further development of the products. An obligation to provide the respective characteristics shall only exist if expressly agreed in the terms of contract. Availability and technical specifications are subject to change without notice.

All product designations may be trademarks or product names of Siemens AG or supplier companies whose use by third parties for their own purposes could violate the rights of the owners.