

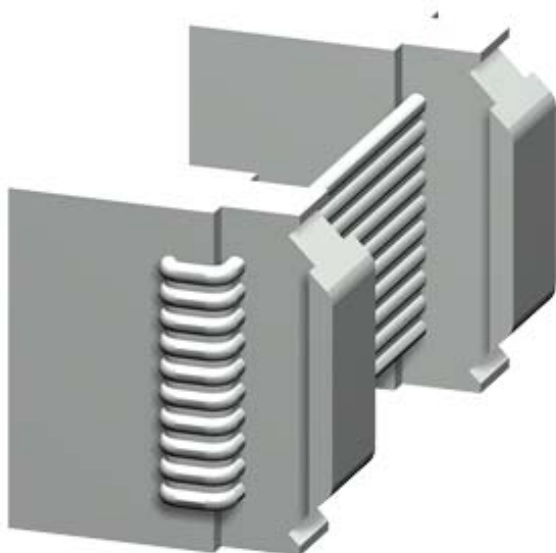





Connecting cable Length 0.1 m, flat, for connection of basic unit, current measuring module, current-voltage measuring module, operator panel or extension modules via the system interface







General technical data:

Product brand name	SIRIUS
Product designation	connecting cable
Design of the product	Length 0.1 m, flat
Ambient temperature	
• during storage	-40 ... +80 °C
• during operation	-25 ... +60 °C
• during transport	-40 ... +80 °C

Certificates/ approvals:

General Product Approval			EMC	Declaration of Conformity	Test Certificates
 CSA	 UL		 C-Tick	 EG-Konf.	Type Test Certificates/Test Report

Shipping Approval				other	
 ABS	 LRS	 PRS	 RMRS	Confirmation	PROFIsafe-Certification

other
PROFINET-Certification  Profibus

Further information

Information- and Downloadcenter (Catalogs, Brochures,...)

<http://www.siemens.com/industrial-controls/catalogs>

Industry Mall (Online ordering system)

<https://mall.industry.siemens.com/mall/en/en/Catalog/product?mlfb=3UF7931-0AA00-0>

Cax online generator

<http://support.automation.siemens.com/WW/CAXorder/default.aspx?lang=en&mlfb=3UF7931-0AA00-0>

Service&Support (Manuals, Certificates, Characteristics, FAQs,...)

<https://support.industry.siemens.com/cs/ww/en/ps/3UF7931-0AA00-0>

Image database (product images, 2D dimension drawings, 3D models, device circuit diagrams, EPLAN macros, ...)

http://www.automation.siemens.com/bilddb/cax_de.aspx?mlfb=3UF7931-0AA00-0&lang=en

