

circuit breaker 3VA2 IEC frame 250 breaking capacity class C
 $I_{cu}=110\text{kA}$ @ 415V 3-pole, motor protection ETU350M, LSI, $I_n=200\text{A}$
 overload protection $I_r=80\text{A}\dots200\text{A}$ short-circuit protection $I_{sd}=3\dots15 \times I_r$, $I_i=15 \times I_n$ nut keeper kit



Model	
Product brand name	SENTRON
Product designation	Molded case circuit breaker
Product version	Motor protection
Design of the overcurrent release	ETU350M
Protective function of the overcurrent release	LSI
Number of poles	3

General technical data	
Rated insulation voltage U_i	800 V
Max. rated operational voltage U_e with AC 50/60Hz	690 V
Operating power / at AC-3 / at 400 V	75 000 W
Operating power / at AC-3 / at 230 V	55 000 W
Power loss [W] / maximum	46 W
Active power loss / for rated value of the current / at AC / in hot operating state / per pole	15.33 W
Mechanical service life (switching cycles) / typical	20 000
Electrical endurance (switching cycles) / at AC-1 / at 380/415 V 50/60 Hz	10 000

Electrical endurance (switching cycles) / at AC-1 / at 690 V 50/60 Hz	5 000
Electrical endurance (switching cycles) / at AC-3 / at 380/415 V 50/60 Hz	6 500
Neutral conductors / upgradeable/retrofitable	No
Ground fault monitoring version	Without
Product function	
• communication function	No
• Phase failure detection	Yes
• other measurement function	No
Net weight	2.3 kg

Current

Max. rated operational current of the frame size	250 A
Rated continuous current I _u	200 A
Operating current	
• at 40 °C	200 A
• at 45 °C	200 A
• at 50 °C	200 A
• at 55 °C	200 A
• at 60 °C	200 A
• at 65 °C	200 A
• at 70 °C	200 A

Switching capacity according to IEC 60947

Switching capacity class of the circuit breaker	C
Maximum short-circuit current breaking capacity (I _{cu})	
• at 240 V	150 kA
• at 415 V	110 kA
• at 440 V	110 kA
• at 500 V	85 kA
• at 690 V	3.6 kA
Operational short-circuit current breaking capacity (I _{cs})	
• at 240 V	150 kA
• at 415 V	110 kA
• at 440 V	110 kA
• at 500 V	85 kA
• at 690 V	3.6 kA
Short-circuit current making capacity (I _{cm})	
• at 240 V	330 kA
• at 415 V	242 kA
• at 440 V	242 kA
• at 500 V	187 kA

• at 690 V

5.4 kA

Adjustable parameters

Adjustable response value current / I _r min.	80 A
Adjustable response value current / I _r max.	200 A
Adjustable response value current / I _{sd} min.	600 A
Adjustable response value current / I _{sd} max.	3 000 A
Short-term delayed / tripping switchable / I _{2t} =ON/OFF	No
Adjustable response value time / t _{sd} min.	0.03 s
Adjustable response value time / t _{sd} max.	0.03 s
Adjustable response value current / I _i min.	3 000 A
Adjustable response value current / I _i max.	3 000 A
Ground fault protection / tripping switchable / I _{2t} =ON/OFF	No

Mechanical Design

Height [in]	7.1 in
Height	181 mm
Width [in]	4.1 in
Width	105 mm
Depth [in]	3.4 in
Depth	86 mm

Connections

Arrangement of electrical connectors / for main current circuit	Front terminal
Type of electrical connection / for main current circuit	on both sides nut keeper kit
Type of connectable conductor cross-section, connection screw, width x thickness , min.	13 x 1 mm
Type of connectable conductor cross-section, connection screw, width x thickness , max.	25 x 8.5 mm

Auxiliary circuit

Number of CO contacts / for auxiliary contacts	0
--	---



Accessories

Product extension / optional / motor drive	Yes
--	-----

Environmental conditions

Protection class IP / on the front	IP40
Ambient temperature	
• during operation / minimum	-25 °C
• during operation / maximum	70 °C
• during storage / minimum	-40 °C
• during storage / maximum	80 °C

Certificates

General Product Approval				EMC	
 CCC	 VDE	CB CB	Miscellaneous	EAC	 RCM

Declaration of Conformity	Test Certificates	Shipping Approval		other	
 EG-Konf.	Miscellaneous	Special Test Certificate	 LRS	CCS / China Classification Society	Confirmation

other	
Manufacturer Declaration	Miscellaneous

Further information

Information- and Downloadcenter (Catalogs, Brochures,...)

<http://www.siemens.com/lowvoltage/catalogs>

Industry Mall (Online ordering system)

<https://mall.industry.siemens.com/mall/en/en/Catalog/product?mlfb=3VA2220-7MN32-0AA0>

Service&Support (Manuals, Certificates, Characteristics, FAQs,...)

<https://support.industry.siemens.com/cs/ww/en/ps/3VA2220-7MN32-0AA0>

Image database (product images, 2D dimension drawings, 3D models, device circuit diagrams, ...)

http://www.automation.siemens.com/bilddb/cax_en.aspx?mlfb=3VA2220-7MN32-0AA0

CAX-Online-Generator

<http://www.siemens.com/cax>

Tender specifications

<http://www.siemens.com/specifications>

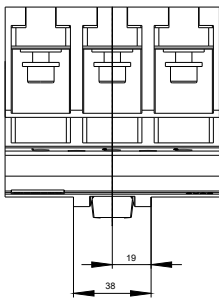
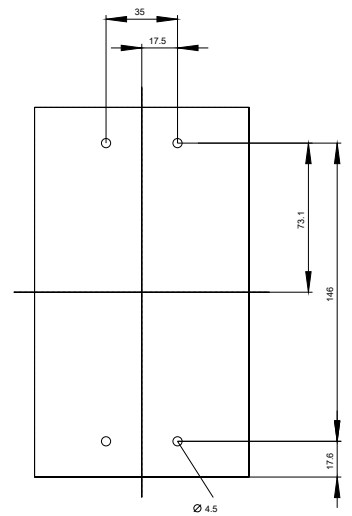
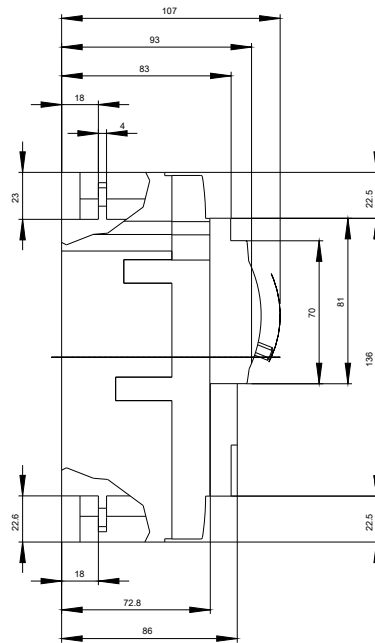
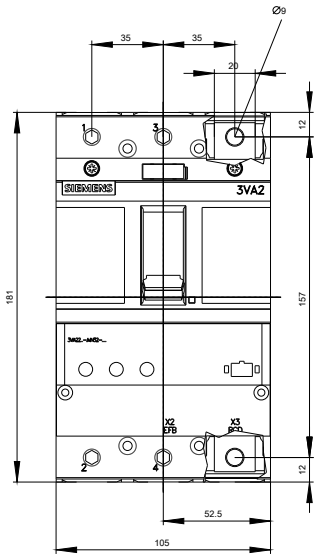

34;-Q 3 5

SIEMENS



last modified:

05/07/2020