

# Molded Case Circuit Breakers

SPEEDFAX™ 2017

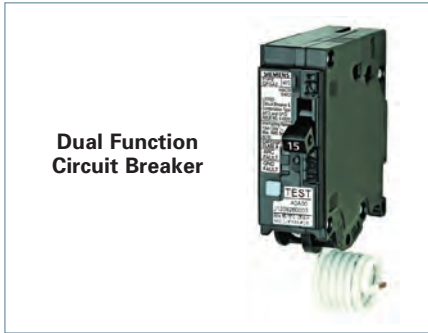

## contents

What's New in Circuit Breakers	7-3 – 7-4
Federal Specifications Classification	7-5
Reference Guides	7-6 – 7-16
<b>Load Center Breakers</b>	
Arc Fault and Ground Fault Breakers	7-17
QP, 1 Inch Breakers	7-18
QT, ½ Inch Breakers	7-19
Special Application Breakers	7-20
QD ¾ Inch Breakers	7-21
Main and Branch Breakers	7-22 – 7-23
Circuit Breaker Dimension Drawings	7-24
Circuit Breaker Lug Data	7-25
Surge Protection	7-26
<b>Panelboard Mounted Circuit Breakers</b>	
BL 240V Breakers	7-27
BL 240V Arc Fault and Ground Fault Breakers	7-28
Special Application 240V Panelboard Mounted Breakers	7-29
BQD 100A Frame 480/277V Breakers	7-30
GB 125A Frame 600/347V Breakers	7-31
NGB2 125A Frame 600/347V Breakers	7-32
Internal Accessories for BQD and NGB Breakers	7-33
<b>General Application Circuit Breakers</b>	
BQ 240V Breakers	7-34
BOXD 240V DIN Rail Mounting Breakers	7-35
QR250 Frame 240V Breakers	7-36
CQD 100A Frame 480/277V Breakers	7-38
GG 125A Frame 600/347V Breakers	7-39
Internal Accessories for CQD and NGG Breakers	7-40
EG 125A Frame 600/347V Breakers and Internal Accessories	7-41 – 7-42
<b>3VA Molded Case Circuit Breakers</b>	
Catalog Numbering System	7-43
3VA51 125A Thermal-magnetic Trip Circuit Breakers	7-44 – 7-45
3VA61 150A Electronic Trip Circuit Breakers	7-46 – 7-49
3VA52 250A Thermal-magnetic Trip Circuit Breakers	7-50 – 7-51
3VA62 250A Electronic Trip Circuit Breakers	7-52 – 7-55
3VA63 400A Electronic Trip Circuit Breakers	7-56 – 7-59
3VA64 600A Electronic Trip Circuit Breakers	7-60 – 7-63
3VA Molded Case Switch and Motor Circuit Protector	7-64
3VA Internal Accessories	7-65
3VA Manual Operators	7-66 – 7-71
3VA Connection Technology	7-72 – 7-78
3VA Plug-in and Draw-out Technology	7-79 – 7-81
3VA Communication and Testing/Commissioning Devices	7-82 – 7-85
3VA Accessories and Electrical Requirements	7-86 – 7-91

(continued on next page)

Scan to connect  
online to the  
most up-to-  
date version of  
this Section of  
SPEEDFAX.





## contents

### Sentron Thermal Magnetic and Electronic Circuit Breakers

Catalog Numbering System	7-92
ED 125A Frame 600V Breakers and Internal Accessories	7-93 – 7-95
FD 250A Frame 600V Breakers and Internal Accessories	7-96 – 7-98
JD/SJD 400A Frame Breakers and Internal Accessories	7-99 – 7-102
LD/SLD 600A Frame Breakers and Internal Accessories	7-103 – 7-106
LMD 800A Frame Breakers and Internal Accessories	7-107 – 7-109
MD/SMD 800A Frame Breakers and Internal Accessories	7-110 – 7-113
ND/SND 1200A Frame Breakers and Internal Accessories	7-114 – 7-117
PD/SPD 1600A Frame Breakers and Internal Accessories	7-118 – 7-120
RD 2000A Frame Breakers and Internal Accessories	7-121
Magnetic Trip Only – ETI Motor Circuit Protectors	7-122 – 7-124
Adjustable Instantaneous Magnetic Trip Settings	7-125 – 7-127
Molded Case Switch – Circuit Disconnect	7-128
Digital Solid State Sentron Sensitrip IV Series Trip Units	7-129 – 7-130
WL Power Circuit Breakers	7-131 – 7-134
Lug Information	7-135 – 7-137
Breaker Modifications	7-138
Internal Accessories – Feature Combinations	7-139
External Accessories	7-142 – 7-147
Unusual Operating Conditions	7-148 – 7-149

### VL Thermal Magnetic and Electronic Circuit Breakers

Catalog Numbering System	7-151 – 7-152
Technical Overview	7-153 – 7-154
Trip Unit Overview	7-155 – 7-156
DG 150A Frame and Internal Accessories	7-157 – 7-160
FG 250A Frame and Internal Accessories	7-161 – 7-164
JG 400A Frame and Internal Accessories	7-165 – 7-168
LG 600A Frame and Internal Accessories	7-169 – 7-172
MG 800A Frame and Internal Accessories	7-173 – 7-176
NG 1200A Frame and Internal Accessories	7-177 – 7-180
PG 1600A Frame and Internal Accessories	7-181 – 7-183
Molded Case Switch	7-184
Motor Circuit Protector	7-185
VL 600 Volt DC Circuit Breakers	7-186
External Accessories	7-187 – 7-201
Accessory Locations	7-202
Suffix for Factory Mounted Internal Accessories	7-203
Technical Data	7-204 – 7-205
Unusual Operating Conditions	7-206 – 7-207

### General Technical

Series Short Circuit Ratings	7-208 – 7-218
Sentron IEC 94702 AC Interrupting Ratings	7-219
Typical Specifications	7-220
Superseded Circuit Breakers	7-221 – 7-223



Sentron Sensitrip

# Molded Case Circuit Breakers

Introduction

What's **new** in molded case circuit breakers:



### New Sentron Sensitrip

Sentron Sensitrip IV ETU Circuit Breakers with Integrated DAS / Maintenance Mode

Design enhancements include:

- Upgraded ETU for NEC 240.87 code compliance (Arc Energy Reduction)
- Frame ratings from 400A to 1600A
- Identical footprint, kAIC ratings and accessory offering as legacy Sensitrip III ETU breakers to ease integration / retrofit
- Maintenance mode versions require customer-supplied 24V external power supply, maintenance switch and light

### The New Siemens QR Circuit Breaker

Implemented in load centers, panelboards, switchboards, meter centers, and modular metering, the new QR breaker is the same form-factor/ mounting as QJ breaker for easy retrofit.

Design enhancements include:

- Trip unit ratings from 100A to 250A.
- Field installable internal accessories – shunt trip, aux switch or shunt/aux combo.
- Two accessory pockets in 3-pole breakers. One accessory pocket in 2-pole breakers.
- High in-rush current capability (450%).
- Push-to-trip button.



### The new Siemens 3VA molded case circuit breakers



- 125A and 250A Thermal Magnetic Trip breakers
- 150A thru 600A Electronic Trip Circuit Breakers
- Extensive and flexible accessories
- Common internal accessories for the entire breaker family
- Power metering with the series-8 LCD electronic trip
- Illuminated rotary handles show switch position
- Smaller footprint than Sentron or VL breakers
- Enhanced Tools and Resources

The **Dual Function Circuit Breaker** combines GFCI and AFCI, protecting against both Arc Faults and Ground Faults. This, along with the new Self-Test & Lockout feature, makes it the first in class in electrical safety for homeowners.

- Faster Installation
- Cost savings
- Smaller Device
- Self Test & Lockout feature as required by UL 943 effective June 2015



The Siemens GG circuit breaker is a compact, industrial design thermal magnetic breaker with valuable features for the global markets. These features include a design that meets multi-national standards, is suitable for DIN rail or base mounting without the need for adapters, and includes UL listed field installable accessories. The GG also has an over center toggle mechanism that is trip free and uses repulsion contact arm construction. Therefore, should a short circuit or tripping condition occur, the contacts are forced apart and the breaker cannot be held closed by means of the handle.



7 MOLDED CASE CIRCUIT BREAKERS

## Ordering

In the FD through RD frames, you may order molded case circuit breakers three basic ways:

- As separately ordered frames, trip units and lugs
- As frame, trip unit and lugs ordered as one catalog number and shipped unassembled or assembled
- As Frame and Trip Unit shipped assembled and with the trip unit made non-removable, in compliance with UL 489 requirements that to be reverse fed the circuit breaker must not have an interchangeable trip unit.

These two options are described in the following:

### Components Ordered Separately

To get the components for a 3-pole, 400 Amp standard interrupting circuit breaker, you would order the frame (JD63F400), the trip unit (JD63T400) and six lugs (TA2J6500). This option is normally useful only if you stock and use large volumes of product and wish to reduce your inventory cost. You may stock, for example, a smaller number of frames (JD63F400) and a variety of trip units (JD63T300, JD63T350, etc.) and assemble breakers as you need them.

### Frame, Trip Unit and Lugs Ordered Together

If you order the catalog number JD63B400, you will receive a frame, a trip unit and 6 lugs in separate packages. By suffixing this number with "L" (e.g. JD63B400L), you will receive frame, trip unit and lugs assembled in one container. Pursuant to UL 489, a product ordered thus will have the markings "LINE" and "LOAD", and may not be "reverse fed" (with power flowing from the "OFF" end of the breaker toward the "ON" end).

### Non-Interchangeable Trip Breakers

If you place an "X" after the frame size designator (e.g. JXD63B400), you will receive a frame and trip unit assembled, with the trip unit made non-removable. If you suffix an "L" to this catalog number (e.g. JXD63B400L), you will receive the breaker, non-removable trip unit and lugs assembled. Unless you anticipate a specific need to change the breaker's ampere rating in the future, this is the preferred ordering method, as the products are assembled to Siemens' specifications in our factories. These breakers are suitable for use reverse fed according to UL 489, since the trip unit is not removable.

The smaller frames (QJ, ED and below) do not have removable trip units, and consequently are shipped only as assembled products. To add lugs, see the ordering instructions on each product's catalog page.

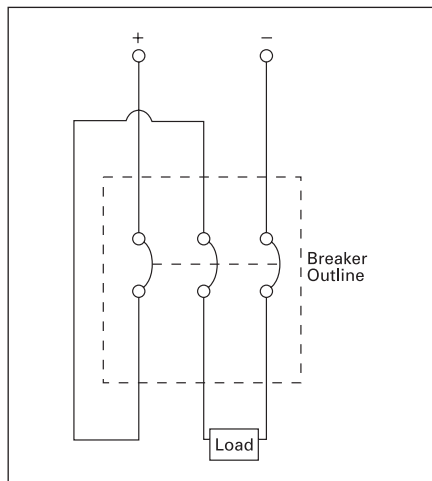

500V DC Wiring Configuration

## Connecting Breakers for DC Application

Most Siemens thermal magnetic trip MCCBs are applicable on direct current (dc) systems. Generally, for 250 V dc systems a two pole breaker is used, with one pole on each leg of the supply circuit. For three pole breakers applied on 500 V undergrounded DC systems, it is important to connect the power supply "zig-zag" through the breaker as shown in the figure below. This assures that the Voltage between phases on the breaker terminals is uniformly distributed.

See below for an alternative connection diagram. For a list of Sentron breakers with the DC ratings, please refer to pages 7-10 to 7-14.

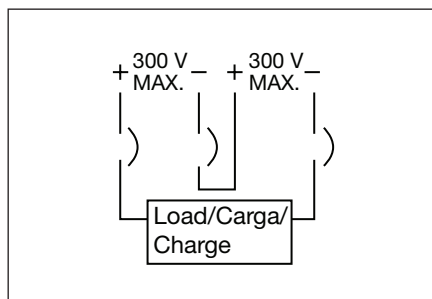

# Molded Case Circuit Breakers

Federal Specification Classification

Reference

## W-C-375C/GEN

Class	Interrupting Rating		Poles	Range of Current Trip <sup>③</sup>	Breaker Type (All Circuit Breakers Meet or Exceed the Indicated Class Level)
	Symmetrical Amperes <sup>①</sup>	Volts AC 60HZ			
10a <sup>②</sup>	5,000	120/240	1 or 2	15–100	QP, BQ, QT, BL
10b	5,000	240	2 or 3	15–100	QP, BQ, BQD, CQD, BL
11a	7,500	120	1	15–100	QP, BQ, BQD, CQD, BL
11b	7,500	240	2 or 3	15–100	QP, BQ, BQD, CQD, BL
12a <sup>②</sup>	10,000	120/240	1 or 2	15–100	QP, BQ, QT, ED2, BL
12b	10,000	240	2 or 3	15–225	QP, BQ, QJ2, ED2, BQD, CQD, BL
12c	10,000	277	1	15–100	BQD, CQD, NGG, NGB, NEG, NEB
13a	14,000	277	1	15–100	ED4, BQD, CQD, NGG, NGB, NEG, NEB
13b	14,000	277/480	1, 2, or 3	15–100	ED4, BQD, CQD
14a	22,000	120/240	1 or 2	15–100	QPH, BQH, BLH
14b	22,000	240	2 or 3	70–400	QJH2, QJ2-H, BQH, BQD, CQD, BLH
15a	65,000	120/240	1 or 2	15–100	HQP, HBQ, ED4, HED4, NGG, NGB
15b	65,000	240	2 or 3	15–225	ED6, ED4, FXD6, FD6, HED4, BQD, CQD, HQJ2H, NGG, NGB, NEG, NEB
16a	100,000	480	2 or 3	15–225	CFD6, CED6
16b	100,000	600	2 or 3	15–600	CED6, CFD6, CJD6, SCJD6, CLD6, SCLD6
17a	200,000	600	2 or 3	70–2000	—
18a	18,000	240	2 or 3	15–125	ED6, HED6, HHED6
	14,000	480			
	14,000	600			
19a	22,000	240	2 or 3	70–225	FXD6, FD6, CFD6, HFD6
	18,000	480			
	14,000	600			
20a	25,000	240	2 or 3	70–225	FXD6-A, FD6-A, CFD6, HFD6
	22,000	480			
	22,000	600			
21a	42,000	240	2 or 3	70–800	HFD6, CFD6, JXD6(A), JD6(A), SJD6-B, HJD(A), HJXD6(A), HHJD6, SHJD6-B, CJD6, SCJD6-B, LXD6(A), LD6(A), SLD6-B, HLD6(A), HLXD6(A), HHL6, SLD6-B, SHLD6-B, CLD6, SCLD6-B, LMD6, LMXD6, HLMD6, HLMXD6, MD6, MXD6, SMD6-B, HMD6, HMXD6, SHMD6-B, CMD6, SCMD6-B
	30,000	480			
	22,000	600			
22a	65,000	240	2 or 3	15–125	CED6, ED6, HED6, HHED6, FXD6-A, FD6-A
	25,000	480			
	18,000	600			
23a	65,000	240	2 or 3	70–1200	HHED6, FXD6-A, FD6-A, HFD6, HHFD6, CFD6, JD6(A), JXD6(A), SJD6-B, HJD(A), HJXD6(A), SHJD6-B, HHJD6, HHJXD6, CJD6, SCJD6-B, LXD6(A), LD6(A), SLD6-B, HLD6(A), HLXD6(A), SHLD6-B, HHL6, HHLXD6, CLD6, SCLD6-B, LMD6, LMXD6, HLMD6, HLMXD6, MD6, MXD6, SMD6-B, HMD6, HMXD6, SHMD6-B, CMD6, SCMD6-B, ND6, NXD6, SND6-B, HND6, HNXD6, SHND6-B, CND6, SCND6-B
	35,000	480			
	25,000	600			
24a	65,000	240	2 or 3	1200–2000	PD6, PXD6, HPD6, HPXD6, CPD6 RD6, RXD6, HRD6, HRXD6, SPD6-B, SHPD6-B
	50,000	480			
	42,000	600			
25a	125,000	240	2 or 3	600–4000	HHL6, CLD6, CMD6, CND6 SCLD6-B, SCMD6-B, SCND6-B, CPD6
	80,000	480			
	60,000	600			

### Applicable Standards

UL489 — Molded Case Circuit Breakers and Circuit Breaker Enclosures.

UL486A — Wire Connectors and Solderless Lugs for use with copper wire

UL486B — Wire Connectors and Solderless Lugs for use with aluminum wire

UL943 — Ground Fault Interrupters (for personnel protectors)

UL1087 — Molded Case Switches

UL50 — Cabinets and Boxes

UL869 — Service Equipment

NEMA AB-1 — Molded Case Circuit Breakers and Molded Case Switches

CSA-C22.2 No. 5, C22.2 No. 14

#### Note:

- (A) Molded case circuit breakers are designed and tested in accordance with applicable portions of UL489 and meet application requirements of the National Electric Code. Unless marked otherwise, circuit breakers are 80% duty rated.  
(B) Molded case circuit breakers are to be connected with 60 or

75°C wire for circuit breakers having a rated ampacity of 100 amperes or less. Circuit breakers having a rated ampacity greater than 100 amperes shall only be cabled with 75°C cable unless otherwise indicated on the circuit breaker label. Exceptions to this rule are outlined in the article 110-14 C(1)(2) of the 2005 National Electric Code.

① Interrupting ratings are not limited to the values or groups of values listed. However, the values listed are minimum values for the class specified.

② Single-unit or duplex construction must be specified.

③ Use minimum frame size for ampere rating.

# Molded Case Circuit Breakers

## Reference Guide

## Selection/Application

### Thermal-Magnetic Trip Breakers

Page	Plug-In Breakers							Panelboard Breakers									
	QT	QP, QPP <sup>②</sup>	QPH, QPPH <sup>②</sup>	HQP, HQPP <sup>②</sup>	HQPPH <sup>②</sup>	QPJ <sup>③</sup>	BL <sup>④</sup>	BLH	HBL	BQD, BQD6	NGB, NGB2 <sup>⑤</sup>	HGB, HGB2 <sup>⑤</sup>	LGB, LGB2 <sup>⑤</sup>				
	7-19	7-20, 7-22	7-20, 7-22	7-18, 7-22	7-18, 7-22	7-22	7-27	7-27	7-27	7-30	7-31	7-31	7-31				
Ratings	Poles	1, 2	1, 2, 3	1, 2, 3	1, 2, 3 <sup>②</sup>	2	2, 3	1,2,3	1,2,3	1,2,3	1,2,3	1,2,3	1,2,3				
	Amperes	15-50	10-125 <sup>③④</sup>	10-125 <sup>③④</sup>	10-125 <sup>③②</sup>	100-225	150-200	10-125	15-125	15-100	15-100	15-125	15-125				
	Volts (50/60 Hz)	1 Pole	120/240	120/240	120/240	120/240	120/240	120/240	120/240	120/240	120/240	277	347	347			
		2 Pole	—	—	—	—	—	—	—	—	—	480/277	600/347	600/347			
		3 Pole	—	240	240	240	240	240	240	240	240	480/277	600/347	600/347			
	AC	Interrupt Rating Symmetrical RMS Amperes	UL	120V	10,000	10,000	22,000	65,000	—	—	10,000	22,000	65,000	65,000	—	—	
				240V	10,000	10,000	22,000	65,000	100,000	10,000	10,000	22,000	65,000	100,000	100,000	100,000	
				277V	—	—	—	—	—	—	—	—	—	14,000	—	—	
				347V	—	—	—	—	—	—	—	—	—	10,000	—	—	
				480/277V	—	—	—	—	—	—	—	—	—	14,000	25,000	35,000	65,000
				480V	—	—	—	—	—	—	—	—	—	—	25,000 <sup>⑥</sup>	35,000 <sup>⑥</sup>	65,000 <sup>⑥</sup>
				600/347V	—	—	—	—	—	—	—	—	—	10,000	14,000	14,000	14,000
				600V	—	—	—	—	—	—	—	—	—	—	—	—	—
				IEC 947-2 50/60Hz <sup>⑦</sup>	220/240V	2-Pole	Icu	—	—	—	—	—	—	—	—	—	—
						Ics	—	—	—	—	—	—	—	—	—	—	—
					380/415V	2-Pole	Icu	—	—	—	—	—	—	—	—	—	—
						Ics	—	—	—	—	—	—	—	—	—	—	—
	500V	2-Pole	Icu		—	—	—	—	—	—	—	—	—	—			
		Ics	—		—	—	—	—	—	—	—	—	—	—			
	DC	125/250 V DC Interrupting Rating	2-Pole	—	—	—	—	—	—	—	—	—	—	—			
3-Pole			—	—	—	—	—	—	—	—	—	—	—				
Dimensions in Inches	Height	10-50A	—	2.87	2.87	—	—	—	—	3.56	3.56	3.75	4.50				
		10-60A	3.12	—	—	—	—	—	—	—	—	—	—				
		55-125A	—	3.12	3.12	3.12	3.12	3 <sup>⑧</sup>	3.75	3.75	3.75	4.50	5.00	5.00			
	Width	1-Pole	1.00	1.00	1.00	1.00	—	—	1.00	1.00	1.00	1.00	1.00	1.00			
		2-Pole	2.00 <sup>⑨</sup>	2.00 <sup>②</sup>	2.00 <sup>②</sup>	2.00	4.00 <sup>②</sup>	⑩	2.00	2.00	2.00	2.00	2.00	2.00			
		3-Pole	2.00 <sup>⑨</sup>	3.00	3.00	3.00	—	3.00 <sup>⑨</sup>	3.00	3.00	3.00	3.00	3.00	3.00			
Depth	2.06	2.37	2.37	2.37	2.37	2.34	2.37	2.37	2.37	2.69	2.71	2.71	2.71				
Overcurrent Devices	Thermal and Fixed magnetic Trip	√	√	√	√	√	√	√	√	√	√	√	√				
	Thermal and Adjustable Magnetic trip	—	—	—	—	—	—	—	—	—	—	—	—				
	Adjustable Magnetic trip only	—	—	—	—	—	—	—	—	—	—	—	—				
	Motor Circuit Protector	—	—	—	—	—	—	—	—	—	—	—	—				
	Molded Case Switch	—	√ <sup>⑥</sup>	—	—	—	—	—	—	—	—	—	—				
Accessories & Modifications	Undervoltage Trip	—	√ <sup>⑥</sup>	√ <sup>⑥</sup>	√ <sup>⑥</sup>	√ <sup>⑥</sup>	—	—	—	—	—	—	—				
	Shunt Trip	—	√ <sup>⑥</sup>	√ <sup>⑥</sup>	√ <sup>⑥</sup>	√ <sup>⑥</sup>	—	—	—	—	—	—	—				
	Auxiliary Switch	—	—	—	—	—	—	—	—	—	—	—	—				
	Alarm Switch	—	—	—	—	—	—	—	—	—	—	—	—				
	Mechanical Interlock	—	—	—	—	—	—	—	—	—	—	—	—				
Individual Enclosures	Fungus Proofing (ref. page 7-138)	—	—	—	—	—	—	—	—	—	—	—					
Type 1 - Indoor Surface	√	√	√	√	√	—	—	—	—	—	—	—					
Type 1 - Indoor, Flush	—	√	√	√	√	—	—	—	—	—	—	—					
Type 3R - Outdoor-Rainproof	—	√	√	√	√	—	—	—	—	—	—	—					

7  
MOLDED CASE  
CIRCUIT BREAKERS



For inches / millimeters conversion, see Application Data section.  
For Plug-in Breakers, see Load Centers & Circuit Breakers section.

① BQD6 CSA certified 10,000A @ 600Y/347V 15-70A only.  
② Types QPP, QPPH, HQPP and HQPPH are special 2-pole configurations for metering equipment. Amperage range = 125-225A, width = 4 in.  
③ Single pole breakers available in ratings 10-70A only.  
④ 125A, 2-pole 120/240V AC only.

⑤ Not applicable to types QPP and QPPH.  
⑥ Single pole circuit breakers available in ratings 15-70A only, 125A available as a 2-pole only.  
⑦ Not applicable to type HQPP and HQPPH.  
⑧ Fits only Siemens EQIII load centers. Breaker is 2 or 3 poles wide.

⑨ 10A, 1-pole & 2-pole 120/240V AC only.  
⑩ When two numbers are shown for the xGB/xGB2 column, the top rating is for xGB and the bottom rating for xGB2.  
⑪ Applicable for 15-30A breakers only.

# Molded Case Circuit Breakers

## Thermal-Magnetic Trip Breakers

Page			General Purpose Breakers												
			BQ	BQH	HBQ	QR2	QRH2	HQR2	HQR2H	CQD	NGG	HGG	LGG		
Ratings	AC	Poles	1, 2, 3	1, 2, 3	1, 2, 3	2, 3	2, 3	2, 3	2, 3	1, 2, 3	1, 2, 3	1, 2, 3	1, 2, 3		
		Amperes, Continuous	1-Pole	15-70	15-70	15-50	—	—	—	—	15-100	15-125	15-125	15-125	
			2-Pole	15-125	15-100	15-70	100-250	100-250	100-250	100-250	15-100	15-125	15-125	15-125	
			3-Pole	15-100	15-100	15-100	100-250	100-250	100-250	100-250	15-100	15-125	15-125	15-125	
		Volts (50/60 Hertz)	1-Pole	120/240	120/240	120/240	—	—	—	—	277	347	347	347	
			2-Pole	240	240	240	240	240	240	240	480/277	600/347	600/347	600/347	
			3-Pole	240	240	240	240	240	240	240	480/277	600/347	600/347	600/347	
		Interrupt Rating Symmetrical RMS Amperes	UL	120V	10,000	22,000	65,000	—	—	—	—	65,000	65,000	65,000	65,000
				240V	10,000	22,000	65,000	10,000	25,000	65,000	100,000	65,000	65,000	65,000	65,000
				480V	—	—	—	—	—	—	—	14,000 <sup>①</sup>	25,000	35,000	65,000
	600/347V			—	—	—	—	—	—	—	10,000 <sup>②</sup>	14,000	22,000	25,000	
	IEC 947-2 50/60Hz		220/240V	1-Pole	Icu	—	—	—	—	—	—	18,000 <sup>③</sup>	25,000	—	—
				Ics	—	—	—	—	—	—	—	9,000 <sup>③</sup>	12,500	—	—
			380/415V	2,3-Pole	Icu	—	—	—	—	—	—	65,000 <sup>④</sup>	65,000	—	—
				Ics	—	—	—	—	—	—	—	32,500 <sup>④</sup>	32,500	—	—
			500V	1-Pole	Icu	—	—	—	—	—	—	—	—	—	—
				Ics	—	—	—	—	—	—	—	—	—	—	—
	DC	Volts — 2-Pole		—	—	—	—	—	—	—	125/250	125/250	125/250	125/250	
		Interrupting Rating — DC Amperes		—	—	—	—	—	—	—	14,000	14,000	14,000	14,000	
	Dimensions in inches	Height	15-50A	3.75	3.75	4.00	—	—	—	—	4.50	5.40	5.40	5.40	
55-125A			4.00	4.00	4.00	—	—	—	—	4.50	5.40	5.40	5.40		
60-225A			—	—	—	7.00	7.00	7.00	7.00	—	—	—	—		
Width		1-Pole	1.00	1.00	1.00	—	—	—	—	1.00	1.00	1.00	1.00		
		2-Pole	2.00	2.00	2.00	3.00	3.00	3.00	3.00	2.00	2.00	2.00	2.00		
	3-Pole	3.00	3.00	3.00	4.50	4.50	4.50	4.50	3.00	3.00	3.00	3.00			
Depth		2.37	2.37	2.37	2.53	2.53	2.53	2.53	2.87	2.90	2.90	2.90			
Overcurrent Devices	Thermal and Fixed Magnetic Trip		√	√	√	√	√	√	√	√	√	√			
	Molded Case Switch		√	—	—	—	—	—	√ <sup>⑤</sup>	—	—	—	—		
Accessories and Modifications	Undervoltage Trip		—	—	—	—	—	—	—	—	—	—			
	Shunt Trip		√	√	√	√	√	√	√	√	√	√			
	Auxiliary Switch		√	√	√	√	√	√	√	√	√	√			
	Alarm Switch		—	—	—	—	—	—	—	√	√	√			
	Mechanical Interlock		—	—	—	√	√	√	√	—	—	—			
Fungus Proofing (ref. page 7-138)		√	√	√	√	√	√	√	√	√	√				
Individual Enclosures	Type 1 — Indoor Surface		√	√	√	√	√	√	—	√	√	√			
	Type 1 — Indoor, Flush		√	√	√	√	√	√	—	√	√	√			
	Type 3R — Outdoor-Rainproof		√	√	√	√	√	√	—	√	√	√			
	Type 5, 12 — Lint, Fine Dust, Oils, Coolants		—	—	—	—	—	—	—	—	√	√			

7  
MOLDED CASE  
CIRCUIT BREAKERS



For inches / millimeters conversion, see Application Data section.

① CQD breakers are rated 14,000 KAIC at 480/277V.  
② Type CQD6—CSA only.

③ 3-pole only.  
④ Applicable for 15-30A breakers only.

# Molded Case Circuit Breakers

3VA UL Breakers

Reference Guide



Type	3VA51	3VA51	3VA52
Page	<b>7-44</b>	<b>7-44</b>	<b>7-50</b>
Number of poles	1	3	2 in 3-pole, 3

### 3VA5 molded case circuit breakers

Size	125 A	125 A	250 A
Rated current $I_n$	A 15 ... 125	15 ... 125	100 ... 250
Frequency	Hz 0 ... 400	0 ... 400	0 ... 400

### Electrical characteristics according to UL 489

Rated operational voltage $U_g$ 50/60 Hz AC	V 347	600Y/347	600
Rated operational voltage $U_g$ DC	V 125	500	600

### Electrical characteristics according to IEC 60947-2

Rated operational voltage $U_g$ 50/60 Hz AC	V 415	690	690
Rated insulation voltage $U_i$	V 500	800	800
Rated impulse withstand voltage $U_{imp}$	kV 8	8	8

### Short-circuit breaking capacity according to UL 489

UL Breaker Type		S			M			H			C		
		SEAS	MEAS	HEAS	SEAS	MEAS	HEAS	MFAS	HFAS	CFAS			
120 V AC / 50/60 Hz	kA	65	85	100	--	--	--	--	--	--	--	--	
240 V AC / 50/60 Hz	kA	--	--	--	65	85	100	85	100	200			
277 V AC / 50/60 Hz	kA	25	35	50	--	--	--	--	--	--			
347 V AC / 50/60 Hz	kA	14	14	14	--	--	--	--	--	--			
480 Y/277 V AC / 50/60 Hz	kA	--	--	--	25	35	65	35	65	100			
480 V AC / 50/60 Hz	kA	--	--	--	25 <sup>1)</sup>	35 <sup>1)</sup>	65 <sup>1)</sup>	35	65	100			
600 Y/347 V AC / 50/60 Hz	kA	--	--	--	14	18 <sup>2)</sup>	25 <sup>3)</sup>	18	25	35			
600 V AC / 50/60 Hz	kA	--	--	--	--	--	--	18	25	35			
125 V DC	kA	14	25	30	--	--	--	--	--	--			
250 V DC	kA	--	--	--	50	85	100	50	85	100			
500 V DC	kA	--	--	--	50	85	100	50	85	100			
600 V DC (3-pole only)	kA	--	--	--	--	--	--	50	85	100			

### Short-circuit breaking capacity according to IEC 60947-2

		S			M			H			C		
		SEAS	MEAS	HEAS	SEAS	MEAS	HEAS	MFAS	HFAS	CFAS			
Rated ultimate short-circuit breaking capacity $I_{cu}$													
Rated service short-circuit breaking capacity $I_{cs}$													
rms value, according to IEC 60947-2													
240 V AC / 50/60 Hz	kA	25/25	36/36	55/55	55/55	85/85	150/150	85/85	100/100	200/200			
415 V AC / 50/60 Hz	kA	5/5	5/5	5/5	36/36	55/55	70/70	55/55	70/70	110/110			
690 V AC / 50/60 Hz	kA	--	--	--	5/5	7/5	10/5	7/7	10/10	10/10			
125 V DC	kA	14	25	30	--	--	--	--	--	--			
250 V DC	kA	--	--	--	50	85	100	50	85	100			
500 V DC	kA	--	--	--	50	85	100	50	85	100			
750 V DC (3-pole only)	kA	--	--	--	--	--	--	50	85	100			

-- Not available

1) Applies to  $I_n$  15 A to 90 A2)  $I_n$  100 A to 125 A 14 kA3)  $I_n$  40 A to 90 A 18 kA; 100 A to 125 A 14 kA



# Molded Case Circuit Breakers

3VA UL Breakers

Reference Guide



3VA61	3VA62	3VA63	3VA64
<b>7-46, 7-47</b>	<b>7-52, 7-53</b>	<b>7-56, 7-57</b>	<b>7-60, 7-61</b>
3, 4	3, 4	3, 4	3, 4
<b>3VA6 molded case circuit breakers</b>			
150 A	250 A	400 A	600 A
40 ... 150	100, 250	250, 400	400, 600
50 ... 60	50 ... 60	50 ... 60	50 ... 60
600	600Y/347	600	600
--	--	--	--
690	690	690	690
800	800	800	800
8	8	8	8

M	H	C	L	M	H	C	L	M	H	C	L	M	H	C	L
MDAE	HDAE	CDAE	LDAE	MFAE-Y	HFAE-Y	CFAE-Y	LFAE-Y	MJAE	HJAE	CJAE	LJAE	MLAE	HLAE	CLAE	LLAE
--	--	--	--	--	--	--	--	--	--	--	--	--	--	--	--
100	100	200	200	100	100	200	200	100	100	200	200	100	100	200	200
--	--	--	--	--	--	--	--	--	--	--	--	--	--	--	--
35	65	100	150	35	65	100	150	35	65	100	150	35	65	100	150
35	65	100	150	35	65	100	150	35	65	100	150	35	65	100	150
18	22	35	50	18	22	35	50	18	22	35	50	18	22	35	50
18	22	35	50	--	--	--	--	18	22	35	50	18	22	35	50
--	--	--	--	--	--	--	--	--	--	--	--	--	--	--	--
--	--	--	--	--	--	--	--	--	--	--	--	--	--	--	--
--	--	--	--	--	--	--	--	--	--	--	--	--	--	--	--

M	H	C	L	M	H	C	L	M	H	C	L	M	H	C	L
85/85	110/110	150/150	200/200	85/85	110/110	150/150	200/200	85/85	110/110	150/150	200/200	85/85	110/110	150/150	200/200
55/55	85/85	110/110	150/150	55/55	85/85	110/110	150/150	55/55	85/85	110/110	150/150	55/55	85/85	110/110	150/150
2.5/2.5	2.5/2.5	2.5/2.5	2.5/2.5	3/3	3/3	3/3	3/3	5/5	5/5	5/5	5/5	6/6	6/6	6/6	6/6
--	--	--	--	--	--	--	--	--	--	--	--	--	--	--	--
--	--	--	--	--	--	--	--	--	--	--	--	--	--	--	--
--	--	--	--	--	--	--	--	--	--	--	--	--	--	--	--

7 MOLDED CASE CIRCUIT BREAKERS

# Molded Case Circuit Breakers

## Thermal-Magnetic Trip Breakers

Page			General Purpose Breakers											
			ED2	ED4	ED6	HED4	HHED6	CED6	FD6A, FXD6A	HFD6, HFXD6	HHFD6, HHFXD6	CFD6		
7-93			7-93	7-93	7-93	7-94	7-94	7-94	7-96	7-97	7-97	7-97		
Ratings	AC	Poles	1, 2, 3	1, 2, 3	1 <sup>Ⓢ</sup> , 2, 3	1, 2, 3	3	2, 3	2, 3	2, 3	2, 3	3		
		Amperes, Continuous	15-100	15-125	15-125 <sup>Ⓢ</sup>	15-125	15-50	15-125	70-250	70-250	70-250	70-250		
		Volts 50/60HZ	1-Pole	120	277	347	277	—	—	—	—	—	—	
			2-Pole	240	480	600	480	600	600	600	600	600	600	
			3-Pole	240	480	600	480	600	600	600	600	600	600	
		Interrupt Rating Symmetrical RMS Amperes	UL	120V	10,000	—	—	100,000	—	—	—	—	—	—
				240V	10,000	65,000	65,000	100,000 <sup>Ⓢ</sup>	100,000	200,000	65,000	100,000	200,000	200,000
				277V	—	22,000 <sup>Ⓢ</sup>	—	65,000 <sup>Ⓢ</sup>	—	—	—	—	—	—
				347V	—	—	30,000	—	—	—	—	—	—	—
				480V	—	18,000	25,000	42,000	65,000	200,000	35,000	65,000	100,000	200,000
	600V			—	—	18,000	—	18,000	100,000	22,000	25,000	25,000	100,000	
	IEC 947-2 50/60HZ		220/240V	lcu	—	—	65,000 <sup>Ⓢ</sup>	—	—	—	65,000	100,000	—	—
				lcs	—	—	17,000 <sup>Ⓢ</sup>	—	—	—	33,000	50,000	—	—
			380/415V	lcu	—	—	35,000 <sup>Ⓢ</sup>	—	—	—	35,000	65,000	—	—
				lcs	—	—	9,000 <sup>Ⓢ</sup>	—	—	—	18,000	33,000	—	—
500V	lcu	—	—	18,000 <sup>Ⓢ</sup>	—	—	—	—	—	—	—			
	lcs	—	—	5,000 <sup>Ⓢ</sup>	—	—	—	—	—	—	—			
DC	2-Pole, 250V DC Interrupting Ratings		5,000	30,000	30,000	30,000	—	30,000	30,000	30,000	—	50,000		
	3-Pole, 500V DC Interrupting Ratings <sup>Ⓢ</sup>		—	—	18,000	—	—	50,000	18,000	25,000	—	50,000		
Dimensions in inches	Height		6.34	6.34	6.34	6.34	6.58	9.26	9.50	9.50	14.12	14.12		
	Width	1-Pole	1.00	1.00	1.00	1.00	—	—	—	—	—	—		
		2-Pole	2.00	2.00	2.00	2.00	2.00	2.00	4.50	4.50	4.50	4.50		
		3-Pole	3.00	3.00	3.00	3.00	3.00	3.00	4.50	4.50	4.50	4.50		
		4-Pole	—	—	—	—	—	—	—	—	—	—		
Depth		4.00	4.00	4.00	4.00	4.00	4.00	4.00	4.00	4.00	4.00			
Overcurrent Devices	Thermal and Fixed Magnetic Trip		✓	✓	✓	✓	✓	✓	—	—	—	—		
	Thermal and Adjustable Magnetic Trip		—	—	—	—	—	—	✓	✓	✓	✓		
	Adjustable Magnetic Trip only		—	—	✓	—	—	✓	—	—	—	✓		
	Motor Circuit Protector		—	—	—	—	—	—	✓	—	—	✓		
	Molded Case Switch		✓	✓	✓	—	—	✓	✓	—	—	✓		
Accessories and Modifications	Undervoltage Trip		✓	✓	✓	✓	✓	✓	✓	✓	✓	✓		
	Shunt Trip		✓	✓	✓	✓	✓	✓	✓	✓	✓	✓		
	Auxiliary Switch		✓	✓	✓	✓	✓	✓	✓	✓	✓	✓		
	Alarm Switch		✓	✓	✓	✓	✓	✓	✓	✓	✓	✓		
	Mechanical Interlock		—	—	—	—	—	—	✓	✓	✓	✓		
	Rear Connection Studs		✓	✓	✓	✓	✓	✓	✓	✓	✓	✓		
	Electric Motor Operator		✓	✓	✓	✓	✓	✓	✓	✓	✓	✓		
	Plug-In Mounting Assembly (3 Pole Only)		✓	✓	✓	✓	✓	✓	✓	✓	✓	✓		
	Fungus Proofing (ref. page 7-138)		✓	✓	✓	✓	✓	✓	✓	✓	✓	✓		
Individual Enclosures	Type 1 — Indoor Surface		✓	✓	✓	✓	✓	✓	✓	✓	✓	✓		
	Type 1 — Indoor, Flush		✓	✓	✓	✓	✓	✓	—	✓	—	✓		
	Type 3R — Outdoor-Rainproof		✓	✓	✓	✓	✓	✓	✓	✓	✓	✓		
	Type 7 — Flammable Gas Atmosphere		✓	✓	✓	✓	✓	—	✓	✓	✓	—		
	Type 9 — Combustion Dusttight		✓	✓	✓	✓	✓	—	✓	✓	✓	—		
	Type 5, 12 — Lint, Fine Dust, Oils, Coolants		✓	✓	✓	✓	✓	✓	✓	✓	✓	✓		
	Type 12K — Semi-Dusttight		✓	✓	✓	✓	✓	✓	✓	✓	✓	✓		

For inches / millimeters conversion, see Application Data section.

- Ⓢ 1-pole only.
- Ⓢ 35-100A: 25,000 AIR at 277V AC/15-30A; 65,000 AIR at 277V AC.
- Ⓢ For DC UPS system application.
- Ⓢ Single pole ED6 (15-30A) 30kA, (35-100A) 18 kA. CSA Only.
- Ⓢ Single pole HED4, 15-30A: 65,000 AIR at 240V AC; single pole HED4, 35-100A: 25,000 AIR at 240V AC.
- Ⓢ HGG and LGG breakers are rated at 600/347V.
- Ⓢ ED6, 2-pole available 20-30 amps only.
- Ⓢ Rating applicable only to 3-pole breakers



# Molded Case Circuit Breakers

## Thermal-Magnetic Trip Breakers

Page			General Purpose Breakers										
			JXD2-A	JD6-A, JXD6-A	HJD6-A, HJXD6-A	HHJD6-A, HHJXD6-A	CJD6-A	LD6, LXD6	HLD6, HLXD6	HHLD6, HHLXD6	CLD6-A		
<b>Ratings</b>			<b>7-99</b>	<b>7-99</b>	<b>7-100</b>	<b>7-100</b>	<b>7-100</b>	<b>7-103</b>	<b>7-104</b>	<b>7-104</b>	<b>7-104</b>		
AC	Poles		2, 3	2, 3	2, 3	2, 3	3	2, 3	2, 3	2, 3	3		
	Amperes, Continuous		200-400	200-400	200-400	200-400	200-400	250-600	250-600	250-600	450-600		
	Volts 50/60HZ		240	600	600	600	600	600	600	600	600		
	Interrupt Rating Symmetrical RMS Amperes	UL	2-Pole	240V	65,000	65,000	100,000	200,000	200,000	65,000	100,000	200,000	200,000
			3-Pole	480V	—	35,000	65,000	100,000	150,000	35,000	65,000	100,000	150,000
			600V	—	25,000	35,000	50,000	100,000	25,000	35,000	50,000	100,000	
		IEC 947-2 50/60HZ <sup>①</sup>	220/ 240V	lcu	—	65,000	100,000	—	—	65,000	100,000	—	—
				lcs	—	33,000	50,000	—	—	33,000	50,000	—	—
			380/ 415V	lcu	—	40,000	65,000	—	—	40,000	65,000	—	—
				lcs	—	20,000	33,000	—	—	20,000	33,000	—	—
				500V	lcu	—	—	—	—	—	—	—	—
	lcs	—	—		—	—	—	—	—	—	—		
DC	2-Pole 250V DC Interrupting Ratings		30,000	30,000	30,000	—	—	30,000	30,000	—	—		
	3-Pole, 500V DC Interrupting Ratings <sup>②</sup>		—	25,000	35,000	—	50,000	35,000	—	—	50,000		
Dimensions in inches	Height		11.00	11.00	11.00	11.00	17.86	11.00	11.00	11.00	17.86		
	Width		7.50	7.50	7.50	7.50	7.50	7.50	7.50	7.50	7.50		
	Depth		4.00	4.00	4.00	4.00	4.00	4.00	4.00	4.00	4.00		
Overcurrent Devices	Thermal and Fixed Magnetic Trip		—	—	—	—	—	—	—	—	—		
	Thermal and Adjustable Magnetic Trip		✓	✓	✓	✓	✓	✓	✓	✓	✓		
	Adjustable Magnetic Trip Only Motor Circuit Protector		—	✓	—	—	✓	✓	—	—	✓		
	Molded Case Switch		✓	✓	✓	—	✓	✓	✓	—	✓		
Accessories & Modifications	Undervoltage Trip		✓	✓	✓	✓	✓	✓	✓	✓	✓		
	Shunt Trip		✓	✓	✓	✓	✓	✓	✓	✓	✓		
	Auxiliary Switch		✓	✓	✓	✓	✓	✓	✓	✓	✓		
	Alarm Switch		✓	✓	✓	✓	✓	✓	✓	✓	✓		
	Mechanical Interlock		✓	✓	✓	✓	✓	✓	✓	✓	✓		
	Rear Connection Studs		✓	✓	✓	✓	✓	✓	✓	✓	✓		
	Electric Motor Operator		✓	✓	✓	✓	✓	✓	✓	✓	✓		
	Plug-In Mounting Assembly		✓	✓	✓	✓	✓	✓	✓	✓	✓		
	Fungus Proofing (ref. page 7-138)		—	✓	✓	✓	✓	✓	✓	✓	✓		
Individual Enclosures	Type 1 — Indoor Surface		✓	✓	✓	✓	✓	✓	✓	✓	✓		
	Type 1 — Indoor, Flush		—	—	—	—	—	—	—	—	—		
	Type 3R — Outdoor-Rainproof		✓	✓	✓	✓	✓	✓	✓	✓	✓		
	Type 7 — Flammable Gas Atmosphere		✓	✓	✓	✓	—	✓	✓	✓	—		
	Type 9 — Combustion Dusttight		✓	✓	✓	✓	—	✓	✓	✓	—		
	Type 5, 12 — Lint, Fine Dust, Oils, Coolants		✓	✓	✓	✓	✓	✓	✓	✓	✓		
Type 12K — Semi-Dusttight		✓	✓	✓	✓	✓	✓	✓	✓	✓			

For inches / millimeters conversion, see Application Data section.

① Only applicable to non-interchangeable trip unit types:  
JXD6-A, HJXD6-A, LXD6 and HLXD6

② For DC UPS application.

# Molded Case Circuit Breakers

## Thermal-Magnetic Trip Breakers

Page			General Purpose Breakers												
			LMD6, LMXD6	HLMD6, HLMXD6	MD6, MXD6	HMD6, HMXD6	CMD6	ND6, NXD6	HND6, HNXD6	CND6	PD6 <sup>2</sup> , PDXD6 <sup>2</sup>	HPD6 <sup>2</sup> , HPXD6 <sup>2</sup>	CPD6 <sup>2</sup>		
Ratings															
AC	Poles		2, 3	2, 3	2, 3	2, 3	3	2, 3	2, 3	3	3	3	3		
	Amperes, Continuous		500-800	500-800	500-800	500-800	400-800	800-1200	800-1200	800-1200	1200-1600	1200-1600	1200-1600		
	Volts 50/60 HZ	2-Pole 3-Pole	600	600	600	600	600	600	600	600	600	600	600		
	Interrupt Rating Symmetrical RMS Amperes	UL	240V	65,000	100,000	65,000	100,000	200,000	65,000	100,000	200,000	65,000	100,000	200,000	
			480V	50,000	65,000	50,000	65,000	100,000	50,000	65,000	100,000	50,000	65,000	100,000	
			600V	25,000	50,000	25,000	50,000	65,000	25,000	50,000	65,000	25,000	50,000	65,000	
		IEC 947-2 50/60HZ <sup>3</sup>	220/ 240V	lcu	—	—	65,000	100,000	—	65,000	100,000	—	—	—	—
				lcs	—	—	33,000	50,000	—	33,000	50,000	—	—	—	—
			380/ 415V	lcu	—	—	40,000	65,000	—	40,000	65,000	—	—	—	—
		lcs	—	—	20,000	33,000	—	20,000	33,000	—	—	—	—		
	500V	lcu	—	—	—	—	—	—	—	—	—	—			
	lcs	—	—	—	—	—	—	—	—	—	—	—			
DC	2-Pole 250V DC Interrupting Ratings		30,000	30,000	30,000	30,000	30,000	30,000	30,000	30,000	30,000	30,000	30,000		
	3-Pole, 500V DC Interrupting Ratings <sup>1</sup>		25,000	50,000	25,000	50,000	50,000	25,000	50,000	50,000	25,000	50,000	50,000		
Dimensions in inches	Circuit breakers require Connect-all mounting block. Dims shown are for circuit breaker only.		Height	16.00	16.00	16.00	16.00	16.00	16.00	16.00	16.00	16.00	16.00		
			Width	7.50	7.50	9.00	9.00	9.00	9.00	9.00	9.00	9.00	9.00		
			Depth	4.59	4.59	6.19	6.19	6.19	6.19	6.19	6.19	6.19	6.19		
Overcurrent Devices	Thermal and Adjustable Magnetic Trip		✓	✓	✓	✓	✓	✓	✓	✓	✓	✓	✓		
	Adjustable Magnetic Trip Only		✓	—	✓	—	✓	—	—	—	—	—	—		
	Motor Circuit Protector		—	—	—	—	—	—	—	—	—	—	—		
	Molded Case Switch		—	—	—	—	—	✓	—	✓	✓	—	—		
Accessories and Modifications	Undervoltage Trip		✓	—	✓	—	✓	✓	✓	✓	✓	✓	✓		
	Shunt Trip		✓	✓	✓	✓	✓	✓	✓	✓	✓	✓	✓		
	Auxiliary Switch		✓	✓	✓	✓	✓	✓	✓	✓	✓	✓	✓		
	Alarm Switch		✓	✓	✓	✓	✓	✓	✓	✓	✓	✓	✓		
	Mechanical Interlock		✓	✓	✓	✓	✓	✓	✓	✓	✓	✓	✓		
	Rear Connections Studs		✓	✓	✓	✓	✓	✓	✓	✓	—	—	—		
	Electric Motor Operator		✓	✓	✓	✓	✓	✓	✓	✓	✓	✓	✓		
	Plug-in Mounting Assembly		✓	✓	✓	✓	✓	✓	✓	✓	—	—	—		
	Fungus Proofing (ref. page 7-138)		—	—	✓	✓	✓	✓	✓	✓	✓	✓	✓		
	Mounting Block (required)		—	—	—	—	—	—	—	—	✓	✓	✓		
Individual Enclosures	Type 1 — Indoor Surface		✓	✓	✓	✓	✓	✓	✓	✓	✓	✓	✓		
	Type 1 — Indoor, Flush		—	—	—	—	—	—	—	—	—	—	—		
	Type 3R — Outdoor-Rainproof		✓	✓	✓	✓	✓	✓	✓	✓	—	—	—		
	Type 7 — Flammable Gas Atmosphere		—	—	—	—	—	—	—	—	—	—	—		
	Type 9 — Combustion Dusttight		—	—	—	—	—	—	—	—	—	—	—		
	Type 5, 12 — Lint, Fine Dust, Oils, Coolants		—	—	—	—	—	—	—	—	—	—	—		
	Type 12K — Semi-Dusttight		✓	✓	✓	✓	✓	✓	✓	✓	—	—	—		

For inches / millimeters conversion, see Application Data section.

<sup>1</sup> For DC UPS application.

<sup>2</sup> Requires Connect-all mounting assembly. Dimensions shown are for circuit breaker only.

<sup>3</sup> Only applicable to non-interchangeable trip unit types: NXD6, HNXD6, MXD6 and HMXD6

# Molded Case Circuit Breakers

## Thermal-Magnetic Trip Breakers & Electronic Trip Breakers

				General Purpose Breakers		Solid State Trip Circuit Breakers							
				RD6 <sup>Ⓞ</sup> RXD6 <sup>Ⓞ</sup>	HRD6 <sup>Ⓞ</sup> HRXD6 <sup>Ⓞ</sup>	SJD6	SHJD6	SCJD6	SLD6	SHLD6	SCLD6		
Page				7-121	7-121	7-101	7-101	7-101	7-105	7-105	7-105		
Ratings	AC	Poles		3	3	3	3	3	3	3	3		
		Amperes, Continuous		1600-2000	1600-2000	200-400	200-400	200-400	300-600	300-600	300-600		
		Volts 50/60 HZ		3-Pole	600	600	600	600	600	600	600	600	
		Interrupt Rating Symmetrical RMS Amperes	UL	240V	65,000	100,000	65,000	100,000	200,000	65,000	100,000	200,000	
				480V	50,000	65,000	35,000	65,000	150,000	35,000	65,000	150,000	
				600V	25,000	50,000	25,000	35,000	100,000	25,000	35,000	100,000	
			IEC60947-2 50/60HZ	220/240V	lcu	—	—	—	—	—	—	—	—
					lcs	—	—	—	—	—	—	—	—
				380/415V	lcu	—	—	—	—	—	—	—	—
					lcs	—	—	—	—	—	—	—	—
				500V	lcu	—	—	—	—	—	—	—	—
					lcs	—	—	—	—	—	—	—	—
			DC	2-Pole 250V DC Interrupting Ratings		30,000	30,000	—	—	—	—	—	—
	3-Pole, 500V DC Interrupting Ratings <sup>Ⓞ</sup>			25,000	50,000	—	—	—	—	—	—		
Dimensions in inches	Height		16.00	16.00	11.00	11.00	17.86	11.0	11.00	17.86			
	Width		3-Pole	9.00	9.00	7.50	7.50	7.50	7.50	7.50	7.50		
	Depth			6.19	6.19	4.00	4.00	4.00	4.00	4.00	4.00		
Overcurrent Devices	Solid State Trip		—	—	✓	✓	✓	✓	✓	✓			
	Optional DAS / Maintenance Mode		—	—	✓	✓	✓	✓	✓	✓			
	Thermal and Adjustable Magnetic Trip		✓	✓	—	—	—	—	—	—			
	Adjustable Magnetic Trip Only Motor Circuit Protector		—	—	—	—	—	—	—	—			
	Molded Case Switch		✓	—	—	—	—	—	—	—			
Accessories & Modifications	Undervoltage Trip		✓	✓	✓	✓	✓	✓	✓	✓			
	Shunt Trip		✓	✓	✓	✓	✓	✓	✓	✓			
	Auxiliary Switch		✓	✓	✓	✓	✓	✓	✓	✓			
	Alarm Switch		✓	✓	✓	✓	✓	✓	✓	✓			
	Mechanical Interlock		✓	✓	✓	✓	✓	✓	✓	✓			
	Rear Connections Studs		—	—	✓	✓	✓	✓	✓	✓			
	Electric Motor Operator		✓	✓	✓	✓	✓	✓	✓	✓			
	Plug-In Mounting Assembly		—	—	✓	✓	✓	✓	✓	✓			
	Fungus Proofing (ref. page 7-138)		✓	✓	✓	✓	✓	✓	✓	✓			
Individual Enclosures	Mounting Block (required)		✓	✓	—	—	—	—	—	—			
	Type 1 — Indoor Surface		✓	✓	✓	✓	✓	✓	✓	✓			
	Type 1 — Indoor, Flush		—	—	—	—	—	—	—	—			
	Type 3R — Outdoor-Rainproof		—	—	✓	✓	—	✓	✓	—			
	Type 7 — Flammable Gas Atmosphere		—	—	✓	✓	—	✓	✓	—			
	Type 9 — Combustion Dusttight		—	—	✓	✓	—	✓	✓	—			
	Type 5, 12 — Lint, Fine Dust, Oils, Coolants		—	—	✓	✓	✓	✓	✓	✓			
Type 12K — Semi-Dusttight		—	—	✓	✓	✓	✓	✓	✓				

For inches / millimeters conversion, see Application Data section.

<sup>Ⓞ</sup> Requires Connect-all mounting assembly. Dimensions shown are for circuit breaker only.

# Molded Case Circuit Breakers

## Reference Guide

## Selection

## Electronic Trip Breakers

Page		Solid State Trip Circuit Breakers										
		SMD6	SHMD6	SCMD6	SND6	SHND6	SCND6	SPD6 <sup>Ⓞ</sup>	SHPD6 <sup>Ⓞ</sup>			
7-112		7-112	7-112	7-112	7-116	7-116	7-116	7-119	7-119			
Ratings	AC	Poles	3	3	3	3	3	3	3			
		Amperes, Continuous	600-800	600-800	600-800	800-1200	800-1200	800-1200	1200-1600	1200-1600		
		Volts 50/60HZ	3-Pole	600	600	600	600	600	600	600		
		Interrupt Rating Symmetrical RMS Amperes	UL	240V	65,000	100,000	200,000	65,000	100,000	200,000	65,000	100,000
				480V	50,000	65,000	100,000	50,000	65,000	100,000	50,000	65,000
				600V	25,000	50,000	65,000	25,000	50,000	65,000	25,000	50,000
			IEC60947-2 50/60HZ	380/415V	lcu	—	—	—	—	—	—	—
					lcs	—	—	—	—	—	—	—
				690V	lcu	—	—	—	—	—	—	—
		lcs	—	—	—	—	—	—	—	—		
Dimensions in inches	Height	10.00	16.00	16.00	16.00	16.00	16.00	16.00	16.00			
	Width	9.00	9.00	9.00	9.00	9.00	9.00	9.00	9.00			
	Depth	6.19	6.19	6.19	6.19	6.19	6.19	6.19	6.19			
Overcurrent Devices	Solid State Trip	✓	✓	✓	✓	✓	✓	✓	✓			
	Optional DAS / Maintenance Mode	✓	✓	✓	✓	✓	✓	✓	✓			
Accessories & Modifications	Undervoltage Trip	✓	✓	✓	✓	✓	✓	✓	✓			
	Shunt Trip	✓	✓	✓	✓	✓	✓	✓	✓			
	Auxiliary Switch	✓	✓	✓	✓	✓	✓	✓	✓			
	Alarm Switch	✓	✓	✓	✓	✓	✓	✓	✓			
	Mechanical Interlock	✓	✓	✓	✓	✓	✓	✓	✓			
	Rear Connection Studs	✓	✓	✓	✓	✓	✓	—	—			
	Electric Motor Operator	✓	✓	✓	✓	✓	✓	✓	✓			
	Plug-In Mounting Assembly	✓	✓	✓	✓	✓	✓	—	—			
Individual Enclosures	Fungus Proofing (ref. page 7-138)	✓	✓	✓	✓	✓	✓	✓	✓			
	Type 1 — Indoor Surface	✓	✓	✓	✓	✓	✓	✓	✓			
	Type 1 — Indoor, Flush	—	—	—	—	—	—	—	—			
	Type 3R — Outdoor-Rainproof	✓	✓	✓	✓	✓	✓	—	—			
	Type 7 — Flammable Gas Atmosphere	—	—	—	—	—	—	—	—			
	Type 9 — Combustion Dusttight	—	—	—	—	—	—	—	—			
	Type 5, 12 — Lint, Fine Dust, Oils, Coolants	✓	✓	✓	✓	✓	✓	—	—			
Type 12K — Semi-Dusttight	✓	✓	✓	✓	✓	✓	—	—				

For inches / millimeters conversion, see Application Data section.

Ⓞ Requires connect-all mounting block assembly. Dimensions shown are for circuit breaker.

# Molded Case Circuit Breakers

Reference Guide

Selection/Application

Page	7-157			7-161			7-165					
Breaker Frame Family	DG			FG			JG					
	Continuous Amps			30–150A			40–250A			70–400A		
	Poles			2, 3			2, 3			2, 3		
	Max. Volts AC			600Y/347V			600Y/347V			600V		
Breaker Type	NDGA	HDGA	LDGA	NFGA	HFGA	LFGA	NJGA	HJGA	LJGA			
Ratings	Interrupting Class			N	H	L	N	H	L	N	H	L
	Interrupting Rating RMS Symmetrical Amperes AC 50/60Hz	UL	240Vac	65	100	200	65	100	200	65	100	200
			480Vac	35	65	100	35	65	100	35	65	100
	I <sub>cu</sub> /I <sub>cs</sub>		600Vac	18	18	18	18	18	18	25	25	25
			220/240Vac	65/65	100/75	200/150	65/65	100/75	200/150	65/65	100/75	200/150
	DC Interrupting Ratings (UL) <sup>②</sup>		380/415Vac	40/40	70/70	100/75	40/40	70/70	100/75	45/45	70/70	100/75
			690Vac	12/6	12/6	12/6	12/6	12/6	12/6	12/6	15/8	15/8
250Vdc (2-Pole)			30	30	30	30	30	30	30	30	30	
		500Vdc (3-Pole) <sup>①</sup>	18	18	18	18	18	30	25	35	35	
		600Vdc (3-Pole) <sup>③</sup>	—	—	—	—	42	—	—	65	—	
Dimensions in Inches	1-Pole			—			—					
	2-Pole			6.9H x 4.1W x 3.4D			11H x 5.5W x 4.2D					
	3-Pole			6.9H x 4.1W x 3.4D			11H x 5.5W x 4.2D					
	4-Pole			—			—					
Trip Unit Information	Thermal-Magnetic			◆			◆			◆		
	Electronic			◆			◆			◆		
	Electronic with LCD			◆			◆			◆		
	Interchangeable Trip Unit			—			—			◆		
	Reverse Feed (w/Non-Interchangeable Trip)			◆			◆			◆		
	Communications Capability <sup>④</sup>			◆			◆			◆		
Specific Application Breakers	Molded Case Switch			◆			◆			◆		
	Motor Circuit Protector			◆			◆			◆		
	100% Rated			◆			◆			◆		
	50°C Calibrated <sup>⑤</sup>											
Accessories & Modifications	Auxiliary Switch			◆			◆			◆		
	Alarm Switch			◆			◆			◆		
	Shunt Trip			◆			◆			◆		
	Undervoltage Release			◆			◆			◆		
	Mechanical Interlocks			◆			◆			◆		
	Electric Motor or Stored Energy Operator			◆			◆			◆		
	Rear Connecting Studs			◆			◆			◆		
	Plug-In Mounting Assy. w/Trip Interlock			◆			◆			◆		
	Draw-Out Assembly			◆			◆			◆		
	Handle Mechanism Options			◆			◆			◆		
Enclosures <sup>⑥</sup>	NEMA 1 – Indoor, Surface Mount			◆			◆					
	NEMA 1 – Indoor, Flush Mount			◆			◆					
	NEMA 3R – Outdoor, Rain Proof			◆			◆					
	NEMA 4, 4X – Stainless Steel			◆			◆					
	NEMA 7, 9 – Hazardous Locations			◆			◆					
	NEMA 12 – Dust			◆			◆					
	Terminal Shields			◆			◆			◆		
	Distribution Lugs			◆			◆			◆		
	Ground Sensor (Neutral Transformer)			◆			◆			◆		

① 500Vdc nominal, 600Vdc max. for ungrounded DC UPS systems.

② DC Interrupting Ratings are not applicable to electronic circuit breakers.

③ Communications available via a COMPRO or COMMOD modules using Profibus or Modbus protocols.

④ Consult Siemens for availability.

⑤ "Non-metallic" NEMA 4X enclosure for NGG breakers.

⑥ Special version, see page 7-186.

GG are not VL family breakers and do not share common VL accessories.

⑦ 304 and 316 Stainless Steel

# Molded Case Circuit Breakers

Page	7-169			7-173			7-177			7-181					
Breaker Frame Family	LG			MG			NG			PG					
	Continuous Amps			150–600A			200–800A			300–1200A			400–1600A		
	Poles			2, 3			2, 3			2, 3			3		
	Max. Volts AC			600V			600V			600V			600V		
Breaker Type			NLGB	HLGB	LLGB	NMG	HMG	LMG	NNG	HNG	LNG	NPG	HPG	LPG	
Ratings	Interrupting Class			N	H	L	N	H	L	N	H	L	N	H	L
	Interrupting Rating RMS Symmetrical Amperes AC 50/60Hz	UL	240Vac	65	100	200	65	100	200	65	100	200	65	100	200
			480Vac	35	65	100	35	65	100	35	65	100	35	65	100
	Symmetrical Amperes AC 50/60Hz	I <sub>CU</sub> / I <sub>CS</sub>	600Vac	18 <sup>⑥</sup>	18	18	25	35	65	25	35	65	25	35	65
			220/240Vac	65/65	100/75	200/150	65/35	100/50	200/150	65/65	100/75	200/100	65/35	100/50	200/100
			380/415Vac	45/45	70/70	100/75	50/50	70/70	100/75	50/25	70/35	100/50	50/25	70/35	100/50
	DC Interrupting Ratings (UL) <sup>③</sup>		690Vac	12/6	15/8	15/8	20/10	30/15	35/17	20/10	30/15	35/17	20/10	30/15	35/15
			250Vdc (2-Pole)	30	30	30	22	25	42	22	25	42	22	25	42
500Vdc (3-Pole) <sup>②</sup>			25	35	35	35	50	65	35	50	65	35	50	65	
Dimensions in Inches	2-Pole			11H x 5.5W x 4.2D			16H x 7.5W x 4.7D			16H x 9W x 6.2D			—		
	3-Pole			11H x 5.5W x 4.2D			16H x 7.5W x 4.7D			16H x 9W x 6.2D					
Trip Unit Information	Thermal-Magnetic			◆			◆			◆			◆		
	Electronic			◆			◆			◆			◆		
	Electronic with LCD			◆			◆			◆			◆		
	Interchangeable Trip Unit			◆			◆			◆			◆		
	Reverse Feed (w/Non-Interchangeable Trip)			◆			◆			◆			◆		
	Communications Capability <sup>①</sup>			◆			◆			◆			◆		
Specific Application Breakers	Molded Case Switch			◆			◆			◆			◆		
	Motor Circuit Protector			◆			◆			◆			◆		
	100% Rated <sup>④</sup>			◆			◆			◆			◆		
Accessories and Modifications	Auxiliary Switch			◆			◆			◆			◆		
	Alarm Switch			◆			◆			◆			◆		
	Shunt Trip			◆			◆			◆			◆		
	Undervoltage Release			◆			◆			◆			◆		
	Mechanical Interlocks			◆			◆			◆			◆		
	Electric Motor or Stored Energy Operator			◆			◆			◆			◆		
	Rear Connecting Studs			◆			◆			◆			◆		
	Plug-In Mounting Assy. w/Trip Interlock			◆			◆			◆			◆		
	Draw-Out Assembly			◆			◆			◆			◆		
	Terminal Shields			◆			◆			◆			◆		
	Distribution Lugs														
	Ground Sensor (Neutral Transformer)			◆			◆			◆			◆		

① Communications available via COMPRO or COMMOD modules using Profibus or Modbus protocol.  
 ② 500Vdc nominal, 600Vdc max. for ungrounded DC UPS systems.  
 ③ DC Interrupting Ratings are not applicable to electronic circuit breakers.  
 ④ LG frame maximum 500A.  
 ⑤ Special version, see page 7-186.  
 ⑥ Special 600Vac 25kA version available, see page 7-170.



# Circuit Breakers

## Arc-Fault and Ground-Fault Breakers

## Selection/Wiring Diagrams

### Arc-Fault Circuit Interrupters (AFCI)

AFCI's detect arcing faults (an unintentional arcing condition in a circuit) that standard circuit breakers are unable to detect. The device is intended to mitigate the effects of arcing faults by functioning to de-energize the circuit when an arc-fault is detected.

#### Combination Type AFCI

Detects all three possible types of arc faults: line-to-ground, line-to-neutral, and series.

Breaker Type	Ampere Rating	10,000 A IR Catalog No.	22,000 A IR Catalog No.	65,000 A IR Catalog No.
<b>QAF2/QAFH2/HQAF2</b> 1-Pole 120V AC	15	QA115AFC ①②	QA115AFCH ①	QA115AFCHH ①
	20	QA120AFC ①②	QA120AFCH ①	QA120AFCHH ①
<b>QAF/QAFH</b> 2-Pole 120/240V AC	15	Q215AFC ①②	Q215AFCH ①	—
	20	Q220AFC ①②	Q220AFCH ①	—

#### Branch-Feeder AFCI

Detects line-to-ground and line-to neutral arcs.

Breaker Type	Ampere Rating	10,000 A IR Catalog No.	22,000 A IR Catalog No.	65,000 A IR Catalog No.
<b>QAF2/QAFH2/HQAF2</b> 1-Pole 120V AC	15	QA115AF ①	QA115AFH ①	QA115AFHH ①
	20	QA120AF ①	QA120AFH ①	QA120AFHH ①

#### NEW Dual Function AFCI/GFCI

The Dual Function Circuit Breaker combines Combination Type AFCI and GFCI, protecting against both Arc Faults and (5mA) Ground Faults. The device includes the Self Test feature, making it the first in class in electrical safety for homeowners.

Breaker Type	Ampere Rating	10,000 A IR Catalog No.	22,000 A IR Catalog No.	65,000 A IR Catalog No.
<b>QFGA2/QFGAH2/HQFGA2</b> 1-Pole 120V AC	15	Q115DF ①②	Q115DFH ①	Q115DFHH ①
	20	Q120DF ①②	Q120DFH ①	Q120DFHH ①

### Ground-Fault Circuit Interrupters (GFCI)

Provides Class A (5mA) ground fault protection. Intended for personnel protection. Includes Self Test as an added safety feature.

Breaker Type	Amp Rating	10,000 A IR Catalog No.	22,000 A IR Catalog No.	65,000 A IR Catalog No.
<b>QPF2/QPHF2/HQPF2</b> 1-Pole 120V AC Plug-in	15	QF115A ②③	QF115AH ①	QF115AHH ①
	20	QF120A ②③	QF120AH ①	QF120AHH ①
	30	QF130A ①	QF130AH ①	QF130AHH ①
<b>QPF/QPHF</b> 2-Pole 120/240V AC Plug-in	15	QF215A	QF215AH ①	—
	20	QF220A	QF220AH ①	—
	30	QF230A	QF230AH ①	—
	40	QF240A	QF240AH ①	—
	50	QF250A	QF250AH ①	—
	60	QF260A	QF260AH ①	—

#### Ground Fault Equipment Protection (30mA)

Provides protection of equipment from damaging line-to-ground faults currents. De-energizes the circuit for all ungrounded conductors of the circuit.

Breaker Type	Ampere Rating	10,000 A IR Catalog No.	22,000 A IR Catalog No.	65,000 A IR Catalog No.
<b>QE/QEH</b> 1-Pole 120V AC Plug-in	15	QE115	QE115H ①	—
	20	QE120	QE120H ①	—
	30	QE130	QE130H ①	—
<b>QE/QEH</b> 2-Pole 120/240V AC Plug-in	15	QE215	QE215H ①	—
	20	QE220	QE220H ①	—
	30	QE230	QE230H ①	—
	40	QE240	QE240H ①	—
	50	QE250	QE250H ①	—
	60	QE260	QE260H ①	—

### QAF2/QPF/QE/QPF2 Accessories

Description	Catalog Number <sup>①</sup>
Padlocking Device 1-Pole	ECPLD1
Padlocking Device 2-Pole	ECPLD2
Handle Block	ECBX231M

■ Built to order. Allow 8 - 10 weeks for delivery.

① UL Listed as SWD (Switching Duty) Rated, suitable for 120V AC Fluorescent Lighting.

② Add WG to the part number for the WireGuide version, see page 1-4 for full selection.

• UL Listed

• HACR Rated



1-Pole Combination Type AFCI



2-Pole Combination Type AFCI



1-Pole Branch Feeder AFCI



1-Pole Dual Function AFCI/GFCI



1-Pole GFCI



2-Pole GFCI



1-Pole Equipment Protection



2-Pole Equipment Protection

### Wiring Diagrams

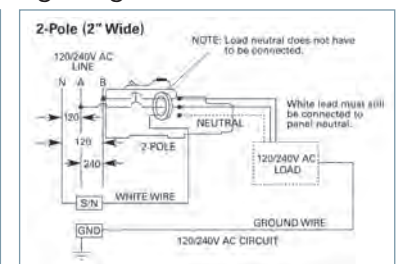
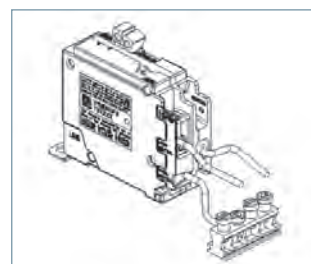

7 MOLDED CASE CIRCUIT BREAKERS

# Circuit Breakers

Type QP with INSTA-WIRE

Selection

Continuous Current Rating @ 40° C	Type QP <sup>①</sup>	Type QPH	Type HQP
	10,000A IR	22,000A IR	65,000A IR
	Catalog Number	Catalog Number	Catalog Number

## 1-Pole Plug-In (120/240V AC)<sup>⑤</sup>

Rating	Type QP <sup>①</sup>	Type QPH	Type HQP
10	Q110 <sup>②</sup>	—	—
15	Q115 <sup>③</sup>	Q115H <sup>④</sup>	Q115HH <sup>③</sup>
20	Q120 <sup>③</sup>	Q120H <sup>③</sup>	Q120HH <sup>③</sup>
25	Q125	Q125H■	Q125HH■
30	Q130	Q130H	Q130HH■
35	Q135■	Q135H■	Q135HH■
40	Q140	Q140H	Q140HH■
45	Q145■	Q145H■	Q145HH■
50	Q150	Q150H	Q150HH■
60	Q160	Q160H■	Q160HH■
70	Q170	Q170H■	Q170HH■



## 2-Pole Plug-In (Common-Trip 120/240V AC)<sup>⑥</sup>

Rating	Type QP <sup>①</sup>	Type QPH	Type HQP
10	Q210 <sup>②</sup>	—	—
15	Q215	Q215H	Q215HH
20	Q220	Q220H	Q220HH
25	Q225	Q225H■	Q225HH■
30	Q230	Q230H	Q230HH
35	Q235	Q235H■	Q235HH■
40	Q240	Q240H	Q240HH■
45	Q245	Q245H■	Q245HH■
50	Q250	Q250H	Q250HH
60	Q260	Q260H	Q260HH
70	Q270	Q270H	Q270HH
80	Q280	Q280H■	Q280HH■
90	Q290	Q290H	Q290HH■
100	Q2100	Q2100H	Q2100HH
110	Q2110	Q2110H	Q2110HH■
125	Q2125	Q2125H	Q2125HH



## 2-Pole Plug-In (Common-Trip 240V AC)<sup>④⑥</sup>

Rating	Type QP <sup>①</sup>	Type QPH	Type HQP
15	Q215R	—	—
20	Q220R	—	—
30	Q230R	—	—
40	Q240R	—	—
50	Q250R	—	—



## 3-Pole Plug-In (Common-Trip 240V AC)<sup>⑦</sup>

Rating	Type QP <sup>①</sup>	Type QPH	Type HQP
15	Q315	Q315H	Q315HH■
20	Q320	Q320H	Q320HH
25	Q325	Q325H■	Q325HH■
30	Q330	Q330H	Q330HH
35	Q335	Q335H■	Q335HH■
40	Q340	Q340H	Q340HH
45	Q345	Q345H■	Q345HH■
50	Q350	Q350H	Q350HH
60	Q360	Q360H	Q360HH
70	Q370	Q370H	Q370HH■
80	Q380	Q380H	Q380HH■
90	Q390	Q390H	Q390HH■
100	Q3100	Q3100H	Q3100HH

## QP / QPH / HQP Internal Accessories

Control Voltage AC	Catalog Number	Field/Factory Installed
120V Shunt Trip	add suffix ...00S01■	Factory
24V Shunt Trip	add suffix ...00S07■	Factory
120V Auxiliary Switch	add suffix ...01■ <sup>②</sup>	Factory

## Modifications

Description	Catalog Number
400 Hz Calibration	add suffix ...Y <sup>⑧</sup>
Marine 50°C Ambient Calibration	add suffix ...M
Fungus Proofing	add suffix ...F

For external accessories, please refer to page 7-140

■ Built to order. Allow 2-3 weeks for delivery.

① UL Listed for use with 60/75° wire through 40 amps, UL listed for use with 75° wire only for 50 amps and above, HACR rated.  
② 1A and 1B contacts.

③ UL Listed for frequent switching applications (SWD). 120V AC Fluorescent Lighting.

④ UL Listed for use on 3-phase grounded "B" systems — 10,000 for this application.  
⑤ Shipped 12 per sleeve.

⑥ Shipped 6 per sleeve.

⑦ Shipped 4 per sleeve.

⑧ UL Listed 5 KA IR.

⑨ Type QP1, UL listed for 16 AWG conductors and multiple wires.

# Circuit Breakers

## Duplex, Triplex and Quadplex Plug-In Breakers

Selection

### Duplex Circuit Breakers

Breaker Type	Ampere Rating	Catalog Number	Catalog Number
<b>QT</b> 1-Pole 10K AIC 120V AC	15-15	<b>Q1515</b>	<b>Q1515NC</b> <sup>①</sup>
	15-20	<b>Q1520</b>	<b>Q1520NC</b> <sup>①</sup>
	20-20	<b>Q2020</b>	<b>Q2020NC</b> <sup>①</sup>
	20-30	<b>Q2030</b>	—
	30-15■	<b>Q3015</b>	—
	30-20	<b>Q3020</b>	—
	30-30	<b>Q3030</b>	<b>Q3030NC</b> <sup>①</sup>
SHIPPING: 12 per carton, (Wt. 4.8 lbs.)			

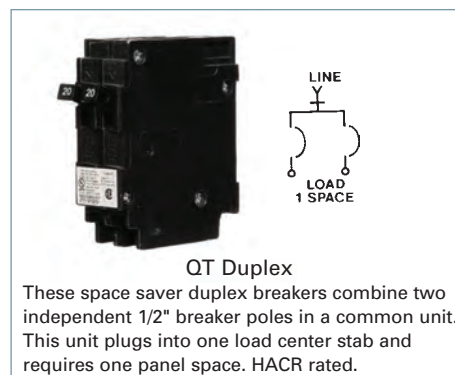

### Triplex Circuit Breakers

Breaker Type	Ampere Rating		Catalog Number	
	Single Pole	Common-Trip 2-Pole		
<b>QT</b> 2-Pole 10K AIC 120/240V AC Inner Poles Common Trip	15	15	<b>Q21515CT</b>	
	15	20	<b>Q21520CT</b>	
	15	25	<b>Q21525CT</b> ■	
	15	30	<b>Q21530CT</b>	
	15	35	<b>Q21535CT</b> ■	
	15	40	<b>Q21540CT</b>	
	15	45	<b>Q21545CT</b> ■	
	15	50	<b>Q21550CT</b>	
	20	20	<b>Q22020CT</b>	
	20	25	<b>Q22025CT</b> ■	
	20	30	<b>Q22030CT</b>	
	20	35	<b>Q22035CT</b> ■	
	20	40	<b>Q22040CT</b>	
	20	45	<b>Q22045CT</b> ■	
	20	50	<b>Q22050CT</b>	
	30	30	<b>Q23030CT</b>	
	SHIPPING: 6 per carton, (Wt. 4.9 lbs.)			

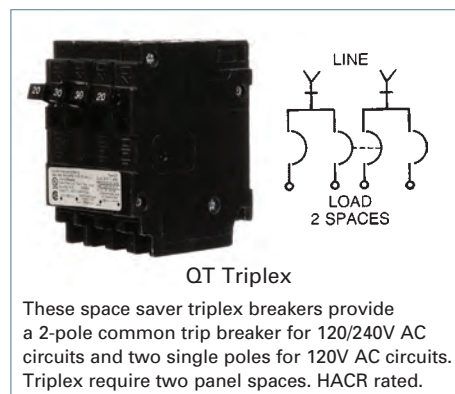

### Quadplex Circuit Breakers

Breaker Type	Ampere Rating		Catalog Number
	Common-Trip 2-Pole Outside	Common-Trip 2-Pole Inside	
<b>QT</b> 2-Pole 10K AIC 120/240V AC Inner and Outer 2 Poles Common Trip	15	15	<b>Q21515CT2</b>
	15	30	<b>Q21530CT2</b>
	20	20	<b>Q22020CT2</b>
	20	50	<b>Q22050CT2</b>
	30	20	<b>Q23020CT2</b>
	30	25	<b>Q23025CT2</b>
	30	30	<b>Q23030CT2</b>
	30	50	<b>Q23050CT2</b>
	40	20	<b>Q24020CT2</b>
	40	30	<b>Q24030CT2</b>
	40	40	<b>Q24040CT2</b>
SHIPPING: 6 per carton, (Wt. 4.8 lbs.)			

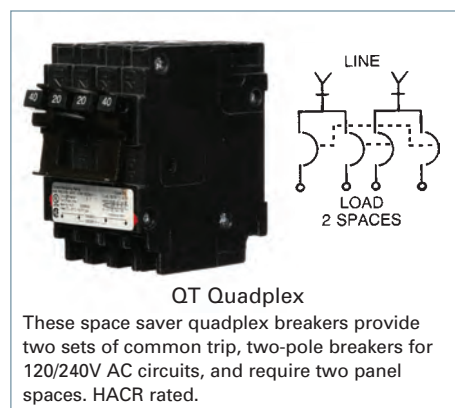

For external accessories, please refer to page 7-140

For inches / millimeters conversion, see Application Data section.

■ Built to order. Allow 2-3 weeks for delivery.

① Non-CTL. For replacement use only in panels manufactured before 1968

# Circuit Breakers

## Special Application Breakers

Selection

### HID Lighting

For high-intensity discharge lamp loads having in-rush currents above the instantaneous trip setting of a standard breaker.

Breaker Type	Wiring Diagram	Complete Breaker UL Unenclosed	
		Ampere Rating	Catalog Number
<b>QP</b> 1-Pole 120V AC	Figure 1	15	Q115HID <sup>Ⓞ</sup> ■
		20	Q120HID <sup>Ⓞ</sup>
		30	Q130HID
<b>QP</b> 2-Pole 120/240V AC	Figure 2	15	Q215HID
		20	Q220HID■
		30	Q230HID■

### Molded Case Switch

For applications that do not require overcurrent protection.

<b>QP</b> 1-Pole 120V AC	Figure 1	100	Q1100S
<b>QP</b> 2-Pole 120/240V AC	Figure 2	30	Q230S
		50	Q250S
		60	Q260S
		125	Q2125S

### No-Noise

For applications that require a reduction in the 60-cycle hum of a standard breaker.

<b>QP</b> 2-Pole 120/240V AC	Figure 2	50	Q250NN■
		60	Q260NN

### Switching Neutrals

Used where all conductors are required to be disconnected. Neutral pole of the circuit breaker does not connect to load center bus. One side is wired to neutral and the other side to the device.

<b>QG</b> 2-Wire Common Trip 120V AC	Figure 3	15	QG215
		20	QG220
<b>QG</b> 3-Wire Common Trip 120/240V AC	Figure 4	20	QG320

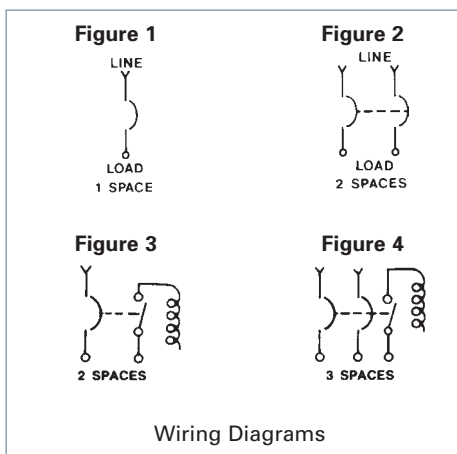

■ Built to order. Allow 2-3 weeks for delivery.  
Note: All circuit breakers on this page are 10K AIC

Ⓞ UL Listed as SWD (Switching Duty) Rated, suitable for 120V AC Fluorescent Lighting.

# Circuit Breakers

## 3/4 Inch Plug-In Breakers

Selection

### Features

- 3/4" format
- HACR Rated
- UL Classified for use in certain Square D load centers

### Type QD Circuit Breakers

The Type QD circuit breaker line is available in 1-pole and 2-pole common trip versions listed on this page.

The circuit breakers are UL Classified and UL Listed.

All QD breakers are supplied with load side connectors suitable for 60/75°C wire and are calibrated for 40°C maximum ambient applications.

### UL Classified

Siemens Type QD circuit breakers are UL Classified for use in specific Square D load centers in place of Square D Type QO® circuit breakers. A Panelboard Compatibility List packaged with each QD breaker shows which type QD circuit breakers are acceptable for use in Square D load centers.

The interrupting rating on these circuit breakers is 10,000A IR maximum and they are **not** series rated with Square D circuit breakers or equipment. This UL Classification allows a Siemens Type QD circuit breaker to be used in place of a Square D Type QO circuit breaker in those load centers that are specifically shown on the Panelboard Compatibility list. For additional information, contact your local Siemens sales engineer.



D120



D220

Continuous Current Rating @ 40°C	1-Pole	2-Pole
	120V	120/240V Common Trip
	Catalog Number	Catalog Number
15	D115 <sup>①</sup>	D215
20	D120 <sup>①</sup>	D220
30	D130	D230
40	D140	D240
50	D150	D250
60	D160	D260

### Shipping Weights

Number of Poles	Number Per Carton	Shipping Weight (lbs.)
1	16	3.8
2	8	4.2

### Panelboard Compatibility List

#### Listed Panelboards—Square D—Catalog Numbers

QO2L30F/S	QO12M100/RB	QO120-30M150/RB	QO130-40M200
QO2-4L70F/S	QO16-20M100/RB	QO124L150G	QO130M200/RB
QO2-4L70TS	QO16M100/RB	QO124M150	QO130-40L200G/RB
QO2-4L70RB	QO20M100/RB	QO130L150G/RB	QO140M200/RB
QO6-12L100F/S	QO112L125G/RB	QO130M150/RB	QO16L200/RB
QO6-12L100DF/S	QO112-24L125G/RB	QO16L150/RB	QO16M200/RB
QO6-12L100TF/S	QO112-24L125GWGC	QO16M150/RB	QO18-16M200FTRB
QO6-12L100DTF/S	QO116L125G	QO16-30L150/RB	QO20-40L200/RB
QO6-12L100RB	QO116-24L125G/RB	QO18-16M150FTRB	QO20-40M200TF/S
QO8-16L100F/S	QO12-24L125/RB	QO20-30M150/RB	QO20-40M200/RB
QO8-16L100DF/S	QO120-24L125G	QO20-30M150TF/S	QO24L200/RB
QO8-16L100TF/S	QO120-24L125GWGC	QO20-30L150	QO24M200/RB
QO8-16L100DTF/S	QO120L125G	QO24L150/RB	QO30L200/RB
QO8-16L100RB	QO124L125G/RB	QO24M150/RB	QO30M200/RB
QO112M100/RB	QO124M125/RB	QO30L150/RB	QO30-40L200/RB
QO116M100/RB	QO16L125/RB	QO30M150/RB	QO30-40M200/RB
QO120M100/RB	QO16-12M125FTRB	QO8-16M200FT/RB	QO40M200/RB
QO124M100	QO16-24L125/RB	QO112L200G/RB	QO140M225
QO12L100DF/S	QO20L125/RB	QO120-40M200/RB	QO142L225G/RB
QO12L100RB	QO20-24L125/RB	QO120-40M200TC	
QO12-20M100/RB	QO24L125/RB	QO124M200	
QO12-20M100TF/S	QO120-30L150G	QO130L200G/RB	

For inches / millimeters conversion, see Application Data section.

① UL Listed for frequent switching applications (SWD). 120V AC Fluorescent Lighting. One or two load conductors.

# Circuit Breakers

## Main and Branch Circuit Breakers<sup>①</sup>

Selection

Breaker Type	Ampere Rating	Catalog Number	Catalog Number	UL Interrupting Ratings (kA)
<b>QN</b> 2-Pole 120/240V AC	150	QN2150	QN2150R <sup>②</sup>	10
	175	QN2175■	QN2175R <sup>②</sup> ■	10
	200	QN2200	QN2200R <sup>②</sup>	10
<b>QNH</b> 2-Pole 120/240V AC	150	QN2150H	QN2150RH <sup>②</sup>	22
	175	QN2175H■	QN2175RH <sup>②</sup> ■	22
	200	QN2200H	QN2200RH <sup>②</sup>	22
<b>HQN</b> 2-Pole 120/240V AC	150	HQN2150	HQN2150R <sup>②</sup>	65
	175	HQN2175■	—	65
	200	HQN2200	HQN2200R <sup>②</sup>	65

Requires 4 panel spaces, 2 adjacent and 2 opposite. **SHIPPING:** 1 per carton (Wt. 3 lbs.)



### Main Breaker Kits

For use in Ultimate Load Centers <sup>③</sup>			For use in EQIII Load Centers			
UL Type	Ampere Rating	Catalog Number	UL Type	Ampere Rating	Catalog Number	UL Interrupting Ratings (kA)
EQ8681	100	MBK100A	EQ9675	100	MBK100	22
EQ8682	125	MBK125A	EQ9677	125	MBK125	22
EQ8693	150	MBK150A	EQ9683	150	MBK150	22
—	—	—	EQ9684	175	MBK175■	22
EQ8695	200	MBK200A	EQ9685	200	MBK200	22
EQ8696	225	MBK225A	EQ9686	225	MBK225	22



Breaker Type	Ampere Rating	Catalog Number	UL Interrupting Ratings (kA)
<b>QPJ</b> <sup>④</sup> 3-Pole 240V AC	125	QPJ3125	10
	150	QPJ3150	10
	200	QPJ3200	10

Requires 6 spaces due to cross over design. Fits only EQIII 125-400A 3-phase load centers

**SHIPPING:** 5 per carton (Wt. 17 lbs.)

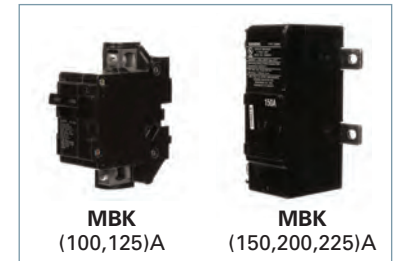

Breaker Type	Ampere Rating	Catalog Number	UL Interrupting Breaker Ratings (kA) Volts AC 120/240
<b>QPP</b> 2-Pole 120/240V AC	125	Q2125B	10
	150	Q2150B	10
	175	Q2175B■	10
	200	Q2200B	10
	225	Q2225B	10
<b>QPPH</b> 2-Pole 120/240V AC	125	Q2125BH	22
	150	Q2150BH	22
	175	Q2175BH■	22
	200	Q2200BH	22
<b>HQPH</b> 2-Pole, 120/240V AC	100	HQ2100H	100
	125	HQ2125H	100
<b>HQPP</b> 2-Pole 120/240V AC	125	Obsolete	
	150		
	175		
	200		
<b>HQPPH</b> 2-Pole 120/240V AC	225	Obsolete	
	100		
	125		
	150		
	175		



For inches / millimeters conversion, see Application Data section.

■ Built to order. Allow 2-3 weeks for delivery.

- ① All circuit breakers on this page are common trip.
- ② Reverse handle.
- ③ CSA Listed.
- ④ MBK100A for use in 100 and 125A load centers.
- MBK125A for use in 125A load centers.
- MBK150A for use in 150, 200 and 225A load centers.
- MBK200A for use in 200 and 225A load centers.
- MBK225A for use in 225A load centers.
- MBK175A for use in 200 and 225A load centers.

⑤ QNR required for horizontal applications or vertical applications where the lugs are facing up. The QN breaker is required for vertical applications where the lugs are facing down as shown.

# Circuit Breakers

## Main and Branch Circuit Breakers

### QS Breaker<sup>①</sup>

PowerMod's core offering of residential Meter Stacks, type WMM, offers the widest product offering & flexibility in the industry. Each meter stack houses the QuickSystem features to maximize productivity and minimize labor costs. To further simplify installation, our 225 Amp meter stacks feature the QS breaker. The QS breaker adds to the Siemens exclusive feature set in our Power Mod product line. Benefits and part numbers include:

- An exclusive side wired design saves wiring space and eliminates difficult "S bends"
- No need for costly filler plates — QS 225 Amp breaker takes the same space as standard 100 Amp QPs
- Single right hand bend wiring - saves time and wire
- Provides 100K AIC flexibility from 100 up to 225 Amps
- 10K to 100K AIC Series Rating

### QS Breaker

Breaker Type	QS	QSH	QSHH	HQS	HQSH
Amperage	10K AIC	22K AIC	42K AIC	65K AIC	100K AIC
100	QS2100	QS2100H	QSH2100	QS2100HH	HQS2100H
110	QS2110	QS2110H	QSH2110	QS2110HH	HQS2110H
125	QS2125	QS2125H	QSH2125	QS2125HH	HQS2125H
150	QS2150	QS2150H	QSH2150	QS2150HH	HQS2150H
175	QS2175	QS2175H	QSH2175	QS2175HH	HQS2175H
200	QS2200	QS2200H	QSH2200	QS2200HH	HQS2200H
225	QS2225	QS2225H	QSH2225	QS2225HH	HQS2225H

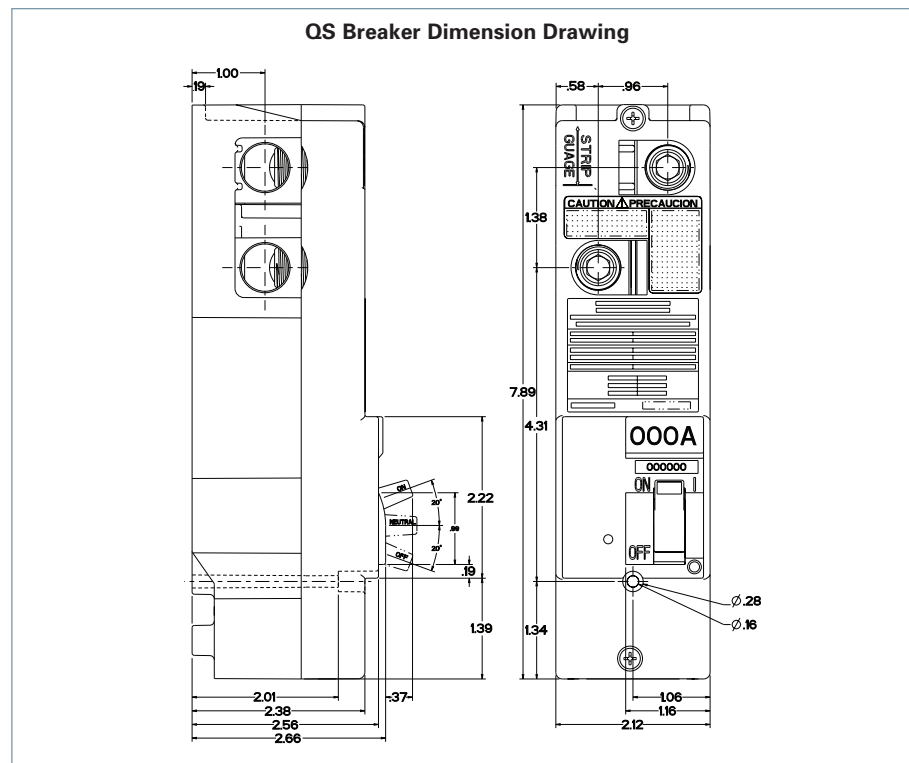

<sup>①</sup> For PowerMod information, please refer to Section 2, page 2-49

7  
MOLDED CASE  
CIRCUIT BREAKERS

# Circuit Breakers

## Line Diagrams

## Dimension Drawings

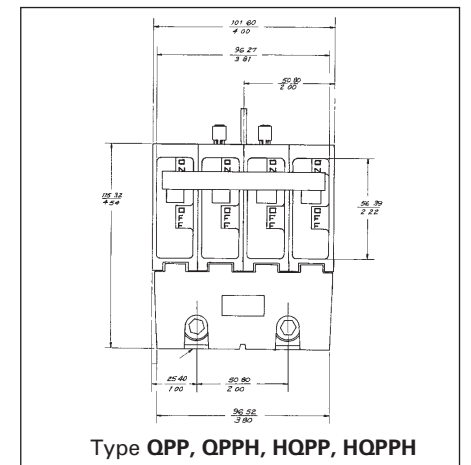
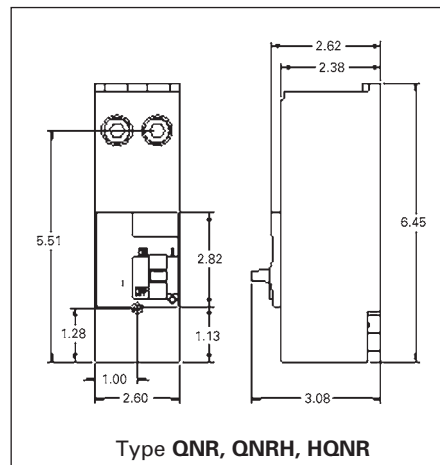
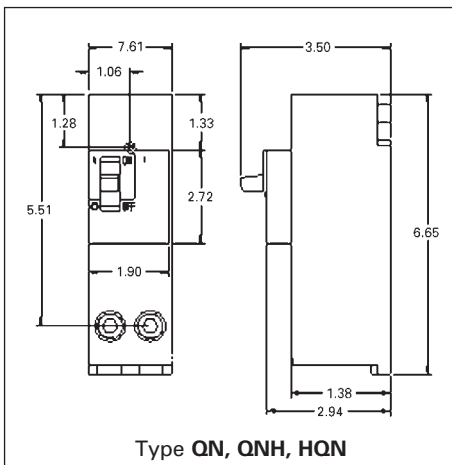
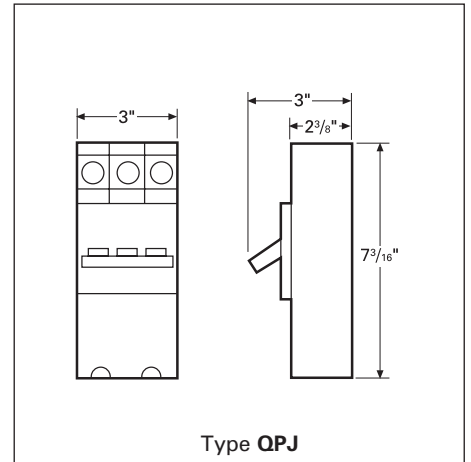
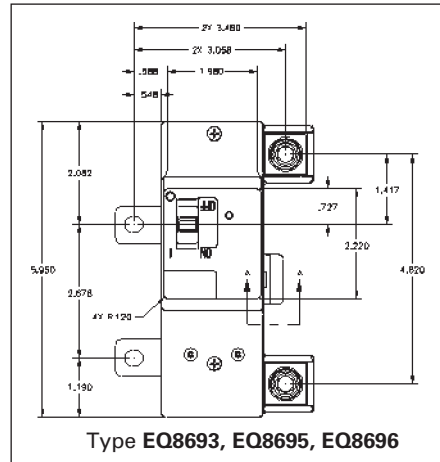
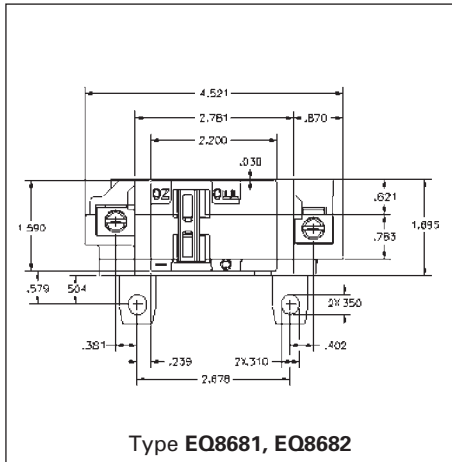
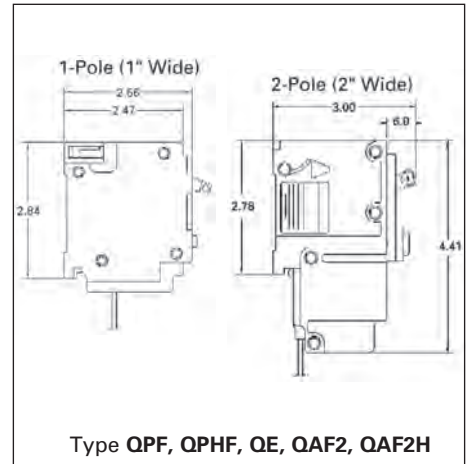
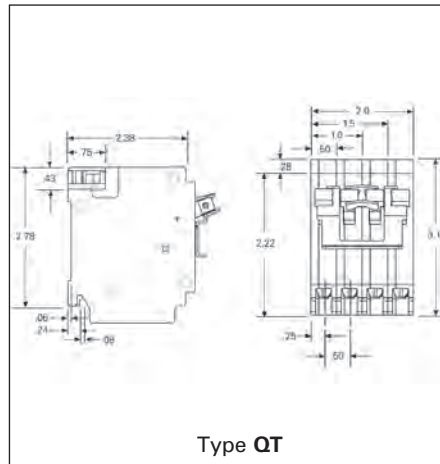
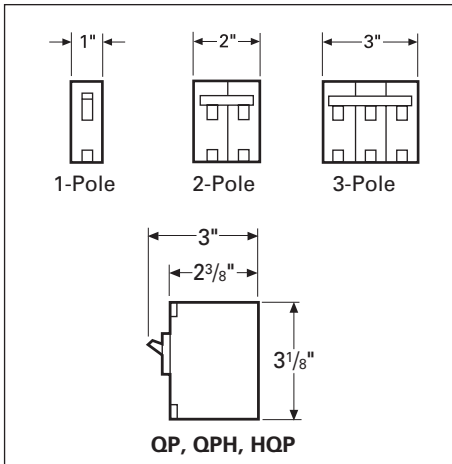

© All standard circuit breakers are calibrated to 40°C maximum ambient application.



## Circuit Breakers

## Lug Data

## Reference

Circuit Breaker Type	Circuit Breaker Ampere Rating	Cables Per Connector	Connector Wire Range
	LOAD SIDE		
QP, QPH, HQP, Plug-in	10	1 or 2	#14-#16 AWG Cu
	15-35	1 1	#14-#6 AWG Cu #14-#6 AWG Al
	40-50	1 1	#8-#6 AWG Cu #8-#4 AWG Al
	55-125	1 1	#8-#2/0 AWG Cu #8-#2/0 AWG Al
QP 1 & 2-Pole Only	55-60	1	#6-#4 AWG Cu-Al (#3 AWG compatible with QPH & HQP)
QT	15-35	1 1	#14-#6 AWG Cu #14-#6 AWG Al
	40	1	#8 AWG CU-Al
	40-50 Exception: 1 & 2-pole QP at 55-60	1 1	#8-#6 AWG Cu #8-#4 AWG Al
QPF, QPHF	15-30	1 1	#14-#10 AWG Cu #12-#8 AWG Al
	40-60	1 1	#8-#6 AWG Cu #8-#4 AWG Al
QAF2, QAFH2, QFGA2, QFGAH2	15-20	1 1	#14-#12 AWG Cu #12-#10 AWG Al
QD	15-20	2	#14-#10 AWG Cu Only
	15-20	1 1	#14-#12 AWG Cu #12-#10 AWG Al
	25-35	1 1	#10-#8 AWG Cu #10-#6 AWG Al
	40-60	1 1	#8-#6 AWG Cu #8-#4 AWG Al
QN, QNH, HQN	150-200	1	#1-300kcmil Cu-Al
QS, QSH, QSHH, HQS, HQSH	100-225	1	#3-300kcmil Cu-Al
EQ8681-Ultimate, PL, ES	100	1	#4-3/0 AWG Cu-Al
EQ8682-Ultimate, PL, ES	125	1	#4-3/0 AWG Cu-Al
EQ8693-Ultimate, PL, ES	150	1	#1-300kcmil Cu-Al
EQ8695-Ultimate, PL, ES	200	1	#1-300kcmil Cu-Al
EQ8696-Ultimate, PL, ES	225	1	#1-300kcmil Cu-Al
QPP, QPPH, HQPP, HQPPH	125	1 1	#1 AWG Cu #2/0 AWG Al
	150	1 1	#1/0 AWG Cu #3/0 AWG Al
	175	1 1	#2/0 AWG Cu #4/0 AWG Al
	200	1 1	#3/0 AWG Cu 250kcmil AWG Al
	225	1 1	#4/0 AWG Cu 300kcmil AWG Al
EQ9675-EQIII	100	1 1	#8-#2/0 AWG Cu #8-#2/0 AWG Al
EQ9677-EQIII	125	1 1	#8-#2/0 AWG Cu #8-#2/0 AWG Al
EQ9683-EQIII	150	1 1	#1/0 AWG Cu #3/0 AWG Al
EQ9684	175	1 1	#3/0 AWG Cu 250kcmil AWG Al
EQ9685-EQIII	200	1 1	#2/0 AWG Cu #4/0 AWG Al
EQ9686-EQIII	225	1 1	#4/0 AWG Cu 300kcmil AWG Al
QPJ	125-200	1	#2-300kcmil Cu-Al

# Surge Protection

## Circuit Breaker and Surge Protective Device (SPD)

### Features

- 2 inch wide plug-on design
  - Includes (2) 1 Pole circuit breakers
  - No loss of load center spaces
- Easy to install and perfect for retrofit
- LEDs provide protection status

### Benefits

By installing a Siemens Circuit Breaker and Surge Protective Device (SPD) in the load center of the residence, surge protection is provided for all branch circuits®.

Two green LED indicator lights are provided to show that surge protection is provided for all circuits connected to the load center. These breakers should be used for circuit protection of frequently used household or facility circuits because the lights and devices connected to these circuits provide an effective indication that surge protection is being provided.

The circuit breaker and SPD utilize Siemens-built 150V AC, 40mm, metal oxide varistors (MOVs). The maximum impulse rating for the SPD module is 40kA. The standard interrupting rating for the circuit breakers is 10k AIC. All Type QP circuit breakers and SPD are plug-on style, with load terminals provided. The devices are rated for 120/240V AC and are calibrated for 40 degrees C maximum ambient applications.



Breaker Type	Ampere Rating	Catalog Number	Surge Type
QP 1- Pole 120/240V AC 10K AIC	(2) 15	QSA1515SPD	SPD
	(2) 20	QSA2020SPD	SPD

<b>Catalog Number</b>	QSA1515SPD QSA2020SPD
<b>Amperage</b>	15 or 20 Amp
<b>Number of Poles</b>	(2) 1-Pole Circuit Breakers
<b>Initial Clamping Level</b>	240 Volts
<b>Transient Energy Rating</b>	360 Joules line-to-neutral 720 Joules line-to-line
<b>Transient Suppression</b>	500 volts peak, line-to-neutral
<b>Voltage Rating</b>	1000 volts peak, line-to-line
<b>Peak Current Rating (impulse)</b>	40,000 amperes
<b>Discharge Voltage Characteristic</b>	@ 1,500A, 600 volts @ 5,000A, 800 volts (both line-to-neutral)
<b>Discharge Current Withstand Rating</b>	10,000 amperes line-to-neutral
<b>Circuit Breaker Interrupting Rating</b>	10,000A, 120/240V AC
<b>Listings/Certifications</b>	UL, CSA Meets UL 1449 4th Edition

© For warranty information please refer to the surge website [www.usa.siemens.com/surge](http://www.usa.siemens.com/surge)

# Molded Case Circuit Breakers

Panelboard Mounting with INSTA-WIRE

Selection

## 1-Pole Bolt-On (120/240V AC)<sup>⑤</sup>

Continuous Current Rating @ 40° C	Type BL <sup>①⑩</sup>	Type BLH <sup>①⑩</sup>	Type HBL <sup>①⑩</sup>
	10,000A IR	22,000A IR	65,000A IR
	Catalog Number	Catalog Number	Catalog Number
10 <sup>⑨</sup>	B110	—	—
15	B115 <sup>④</sup>	B115H <sup>④</sup>	B115HH <sup>④</sup>
20	B120 <sup>④</sup>	B120H <sup>④</sup>	B120HH <sup>④</sup>
25	B125	B125H	B125HH
30	B130	B130H	B130HH
35	B135	B135H	B135HH
40	B140	B140H	B140HH
45	B145	B145H	B145HH
50	B150	B150H	B150HH
60	B160	B160H	B160HH
70	B170	B170H	B170HH



## 2-Pole Bolt-On (Common-Trip 120/240V AC)<sup>④</sup>

10	B210	—	—
15	B215	B215H	B215HH
20	B220	B220H	B220HH
25	B225	B225H	B225HH
30	B230	B230H	B230HH
35	B235	B235H	B235HH
40	B240	B240H	B240HH
45	B245	B245H	B245HH
50	B250	B250H	B250HH
60	B260	B260H	B260HH
70	B270	B270H	B270HH
80	B280	B280H	B280HH
90	B290	B290H	B290HH
100	B2100	B2100H	B2100HH
110	B2110	B2110H	B2110HH
125	B2125	B2125H	B2125HH

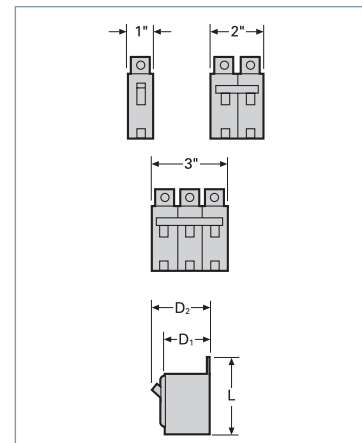

## 2-Pole Bolt-On (Common-Trip 240V AC)<sup>③⑥⑩</sup>

15	B215R	—	—
20	B220R	—	—
30	B230R	—	—
40	B240R	—	—
50	B250R	—	—

## 3-Pole Bolt-On (Common-Trip 240V AC)<sup>⑦</sup>

15	B315	B315H	B315HH
20	B320	B320H	B320HH
25	B325	B325H	B325HH
30	B330	B330H	B330HH
35	B335	B335H	B335HH
40	B340	B340H	B340HH
45	B345	B345H	B345HH
50	B350	B350H	B350HH
60	B360	B360H	B360HH
70	B370	B370H	B370HH
80	B380	B380H	B380HH
90	B390	B390H	B390HH
100	B3100	B3100H	B3100HH

Breaker Type	Amperes	Dimensions		
		L	D <sub>1</sub>	D <sub>2</sub>
BL, BLH	15-50	3 <sup>3</sup> / <sub>16</sub>	2 <sup>3</sup> / <sub>8</sub>	3
BL, BLH	55-125	3 <sup>3</sup> / <sub>8</sub>	2 <sup>3</sup> / <sub>8</sub>	3
HBL	15-125	3 <sup>3</sup> / <sub>8</sub>	2 <sup>3</sup> / <sub>8</sub>	3

## BL/BLH/HBL Internal Accessories

Description	Catalog Number	Field/Factory Installed
120VAC Shunt Trip	add suffix...00S01	Factory
24VAC Shunt Trip	add suffix...00S07	Factory
120V Auxiliary Switch	add suffix...01	Factory

## Modifications

Description	Catalog Number
400Hz Calibration	add suffix...Y
Marine 50°C Ambient Calibration	add suffix...M
Fungus Proofing	add suffix...F

For external accessories, please refer to page 7-140

■ Built to order. Allow 2-3 weeks for delivery

① UL Listed for use with 60/75° wire through 40 amps, UL listed for use with 75° wire only for 50 amps and above, HACR rated. 120V AC Fluorescent Lighting. ② 1A and 1B contacts.

③ UL Listed for use on 3-phase grounded "B" systems — 10,000 for this application. ④ UL Listed for frequent switching applications (SWD). ⑤ Shipped 12 per sleeve. ⑥ Shipped 6 per sleeve.

⑦ Shipped 4 per sleeve. ⑧ UL Listed 5KA IR. ⑨ 10 Amp breaker does not have INSTA-WIRE. ⑩ For 3 Phase Applications. ⑪ UL Listed for reverse feed."

# Molded Case Circuit Breakers

## Panelboard Mounting Circuit Breakers

## Selection

### Arc-Fault Circuit Interrupters (AFCI)

AFCI's detect arcing faults (an unintentional arcing condition in a circuit) that standard circuit breakers are unable to detect. The device is intended to mitigate the effects of arcing faults by functioning to de-energize the circuit when an arc-fault is detected.

### Combination Type AFCI

Detects all three possible types of arc fault: line-to-ground, line-to-neutral, and series.

Breaker Type	Ampere Rating	10,000 A IR Catalog Number	22,000 A IR Catalog Number	65,000 A IR Catalog Number
<b>BAF2/BAFH2/HBAF2</b> 1-Pole 120V AC	15	BA115AFC <sup>Ⓞ</sup>	BA115AFCH■	BA115AFCHH■
	20	BA120AFC <sup>Ⓞ</sup>	BA120AFCH■	BA120AFCHH■
<b>BAF/BAFH</b> 2-Pole 120/240V AC	15	B215AFC <sup>Ⓞ</sup>	B215AFCH■	—
	20	B220AFC <sup>Ⓞ</sup>	B220AFCH■	—

### Branch-Feeder AFCI

Detects line-to-ground and line-to neutral arcs.

Breaker Type	Ampere Rating	10,000 A IR Catalog Number	22,000 A IR Catalog Number	65,000 A IR Catalog Number
<b>BAF2/BAFH2/HBAF2</b> 1-Pole 120V AC	15	BA115AF <sup>Ⓞ</sup>	BA115AFH■ <sup>Ⓞ</sup>	BA115AFHH■
	20	BA120AF <sup>Ⓞ</sup>	BA120AFH■ <sup>Ⓞ</sup>	BA120AFHH■

### **NEW** Dual Function AFCI/GFCI

The Dual Function Circuit Breaker combines Combination Type AFCI and GFCI, protecting against both Arc Faults and (5mA) Ground Faults. The device includes the Self Test feature, making it the first in class in electrical safety for homeowners.

Breaker Type	Ampere Rating	10,000 A IR Catalog Number	22,000 A IR Catalog Number	65,000 A IR Catalog Number
<b>BFGA2/BFGAH2/HBFGA2</b> 1-Pole 120V AC	15	B115DF	B115DFH■	B115DFHH■
	20	B120DF	B120DFH■	B120DFHH■

### Ground-Fault Circuit Interrupters (GFCI)

Provides Class A (5mA) ground fault protection. Intended for personnel protection. De-energizes the circuit for all ungrounded conductors of the circuit.

Breaker Type	Amp Rating	10k A IR Cat. No.	22k A IR Cat. No.	65k A IR Cat. No.
<b>BLF/BLHF</b> 1-Pole 120V AC Bolt-On	15	BF115A <sup>Ⓞ</sup>	BF115AH <sup>Ⓞ</sup>	BF115AHH■
	20	BF120A <sup>Ⓞ</sup>	BF120AH <sup>Ⓞ</sup>	BF120AHH■
	25	BF125A	BF125AH■	BF125AHH■
	30	BF130A	BF130AH	BF130AHH■
<b>BLF/BLHF</b> 2-Pole 120/240V AC Bolt-On	15	BF215A	BF215AH■	—
	20	BF220A	BF220AH■	—
	30	BF230A	BF230AH	—
	40	BF240A	BF240AH■	—
	50	BF250A	BF250AH■	—
	60	BF260A	BF260AH■	—

### Ground Fault Equipment Protection (30mA)

Provides protection of equipment from damaging line-to-ground faults currents. De-energizes the circuit for all ungrounded conductors of the circuit.

Breaker Type	Amp Rating	10k A IR Cat. No.	22k A IR Cat. No.
<b>BLE/ BLEH</b> 1-Pole, 120V AC Bolt-On	15	BE115 <sup>Ⓞ</sup>	BE115H■ <sup>Ⓞ</sup>
	20	BE120 <sup>Ⓞ</sup>	BE120H■ <sup>Ⓞ</sup>
	30	BE130	BE130H■
<b>BLE/ BLEH</b> 2-Pole 120/240V AC Bolt-On	15	BE215	BE215H■
	20	BE220	BE220H■
	30	BE230	BE230H■
	40	BE240	BE240H■
	50	BE250	BE250H■
	60	BE260	BE260H■

### QAF2/QPF/QE Accessories

Description	Catalog Number
Padlocking Device 1-Pole	ECPLD1
Padlocking Device 2-Pole	ECPLD2
Handle Block	ECBX231M

### Wiring Diagrams

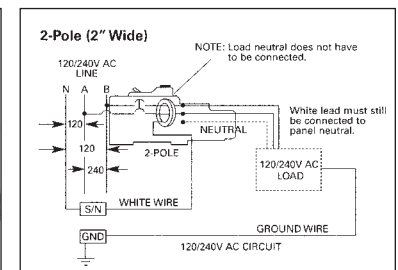
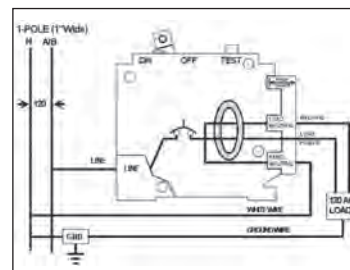

• UL Listed

• HACR Rated



■ Built to order. Allow 8 -10 weeks for delivery.  
 Ⓞ UL Listed as SWD (Switching Duty) Rated, suitable for 120V AC Fluorescent Lighting.

# Molded Case Circuit Breakers

## Special Application Breakers

### Switching Neutrals<sup>①</sup>

Breaker Type	Ampere Rating	Catalog Number
<b>BLG</b> 2-Wire Common Trip	15 20	<b>BG215</b> ■ <b>BG220</b> ■
<b>BLG</b> 3-Wire Common Trip	30	<b>BG330</b> ■

### HID Lighting<sup>①</sup>

For high-intensity discharge lamp loads having in-rush currents above the instantaneous trip setting of a standard breaker.

<b>BL</b> 1-Pole	15	<b>B115HID</b> ②■
	20	<b>B120HID</b> ②
	30	<b>B130HID</b> ■
<b>BL</b> 2-Pole	15	<b>B215HID</b> ②■
	20	<b>B220HID</b> ②
	30	<b>B230HID</b> ■

### Molded Case Switch

For applications that do not require overcurrent protection.

<b>BL</b> 2-Pole	30	<b>B230S</b>
---------------------	----	--------------



■ Built to order. Allow 2–3 weeks for delivery.

① HACR rated.

② UL Listed for frequent switching applications (SWD). 120V AC fluorescent lighting.

# Molded Case Circuit Breakers

## BOD 100A Frame Panelboard Mounting Circuit Breakers

## Selection/Dimensions

### BOD<sup>®</sup>

Continuous Current Rating @ 40°C	1-Pole	2-Pole <sup>®</sup>	3-Pole <sup>®</sup>
	277V AC–125V DC	480Y/277V AC–125/250V DC	480Y/277V AC
	Catalog Number	Catalog Number	Catalog Number
15	BOD115 <sup>①②</sup>	BOD215 <sup>③</sup>	BOD315 <sup>③</sup>
20	BOD120 <sup>①②</sup>	BOD220 <sup>③</sup>	BOD320 <sup>③</sup>
25	BOD125 <sup>②</sup>	BOD225 <sup>③</sup>	BOD325 <sup>③</sup>
30	BOD130 <sup>②</sup>	BOD230 <sup>③</sup>	BOD330 <sup>③</sup>
35	BOD135 <sup>②</sup>	BOD235 <sup>③</sup>	BOD335 <sup>③</sup>
40	BOD140 <sup>②</sup>	BOD240 <sup>③</sup>	BOD340 <sup>③</sup>
45	BOD145 <sup>②■</sup>	BOD245 <sup>③</sup>	BOD345 <sup>③</sup>
50	BOD150 <sup>②</sup>	BOD250 <sup>③</sup>	BOD350 <sup>③</sup>
60	BOD160	BOD260	BOD360
70	BOD170■	BOD270	BOD370
80	BOD180■	BOD280	BOD380
90	BOD190■	BOD290	BOD390
100	BOD1100■	BOD2100	BOD3100

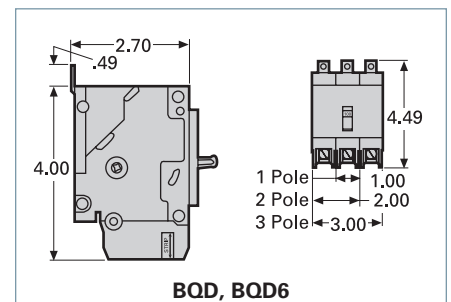

### BOD6 CSA Certified

Continuous Current Rating @ 40°C	1-Pole	2-Pole <sup>®</sup>	3-Pole <sup>®</sup>
	347V AC	600/347V AC	600/347V AC
	Catalog Number	Catalog Number	Catalog Number
15	BOD6115 <sup>①</sup>	BOD6215	BOD6315
20	BOD6120 <sup>①</sup>	BOD6220	BOD6320
25	BOD6125■	BOD6225■	BOD6325■
30	BOD6130	BOD6230	BOD6330
35	BOD6135■	BOD6235■	BOD6335■
40	BOD6140■	BOD6240■	BOD6340
45	BOD6145■	BOD6245■	BOD6345■
50	BOD6150■	BOD6250■	BOD6350
60	BOD6160■	BOD6260■	BOD6360
70	BOD6170■	BOD6270■	BOD6370

### Shipping Weights

Number of Poles	Number per Carton	Shipping Weight (lbs.) (ea.)
1	1/12/48	.6
2	1/6/24	1.2
3	1/4/16	2.0

### Interrupting Ratings (max. RMS symmetrical amperes kA)

Breaker Type	Number of Poles	UL								IEC 947-2 <sup>®</sup>			
		Volts AC						Volts DC		Volts AC			
		120	240	277	480/277	347	600/347	125	125/250	220/240		380/415	
									<i>I<sub>cu</sub></i>	<i>I<sub>cs</sub></i>	<i>I<sub>cu</sub></i>	<i>I<sub>cs</sub></i>	
BOD	1-Pole	65	—	14	—	—	—	14	—	18	9	—	—
	2-Pole	—	65	—	14	—	—	—	14	65	33	18	9
	3-Pole	—	—	65	—	14	—	—	14	65	33	18	9
BOD6	1-Pole	—	—	—	—	10	—	14	—	18	9	—	—
	2-Pole	—	—	—	—	—	10	—	14	65	33	18	9
	3-Pole	—	—	—	—	—	10	—	—	65	33	18	9

### Lugs For 60/75°C Wire

BOD – Load End Only	
15–40	#14–#6 AWG Cu #12–#6 AWG Al
45–100	#8–#1 AWG Cu #6–#1/0 AWG Al

For inches / millimeters conversion, see Application Data section.

■ Built to order. Allow 2–3 weeks for delivery.

① SWD rated for switching fluorescent lighting.  
② HID rated at 277V AC.

③ Not suitable for 3-phase delta 480V applications.

④ HACR rated.

⑤ HID rated at 480Y/277V AC.

⑥ Applicable for 15–30A breakers only

For external accessories, please refer to pages 7-142 to 7-147  
For internal accessories, please refer to page 7-33

# Molded Case Circuit Breakers

GB Frame

Selection

## Type NGB Frame<sup>®</sup> (Panelboard Mount)

Continuous Current Rating @ 40°C	1-Pole	2-Pole	3-Pole
	Catalog Number	Catalog Number	Catalog Number
15	NGB1B015B <sup>①②</sup>	NGB2B015B <sup>②</sup>	NGB3B015B <sup>②</sup>
20	NGB1B020B <sup>①②</sup>	NGB2B020B <sup>②</sup>	NGB3B020B <sup>②</sup>
25	NGB1B025B <sup>②</sup>	NGB2B025B <sup>②</sup>	NGB3B025B <sup>②</sup>
30	NGB1B030B <sup>②</sup>	NGB2B030B <sup>②</sup>	NGB3B030B <sup>②</sup>
35	NGB1B035B <sup>②</sup>	NGB2B035B <sup>②</sup>	NGB3B035B <sup>②</sup>
40	NGB1B040B <sup>②</sup>	NGB2B040B <sup>②</sup>	NGB3B040B <sup>②</sup>
45	NGB1B045B <sup>②</sup>	NGB2B045B <sup>②</sup>	NGB3B045B <sup>②</sup>
50	NGB1B050B <sup>②</sup>	NGB2B050B <sup>②</sup>	NGB3B050B <sup>②</sup>
60	NGB1B060B	NGB2B060B	NGB3B060B
70	NGB1B070B	NGB2B070B	NGB3B070B
80	NGB1B080B	NGB2B080B	NGB3B080B
90	NGB1B090B	NGB2B090B	NGB3B090B
100	NGB1B100B	NGB2B100B	NGB3B100B
110	NGB1B110B	NGB2B110B	NGB3B110B
125	NGB1B125B	NGB2B125B	NGB3B125B



Load lugs are included as standard. HACR rated.

## Type HGB<sup>®</sup> (Panelboard Mount)

Continuous Current Rating @ 40°C	1-Pole	2-Pole	3-Pole
	Catalog Number	Catalog Number	Catalog Number
15	HGB1B015B <sup>①②</sup>	HGB2B015B <sup>②</sup>	HGB3B015B <sup>②</sup>
20	HGB1B020B <sup>①②</sup>	HGB2B020B <sup>②</sup>	HGB3B020B <sup>②</sup>
25	HGB1B025B <sup>②</sup>	HGB2B025B <sup>②</sup>	HGB3B025B <sup>②</sup>
30	HGB1B030B <sup>②</sup>	HGB2B030B <sup>②</sup>	HGB3B030B <sup>②</sup>
35	HGB1B035B <sup>②</sup>	HGB2B035B <sup>②</sup>	HGB3B035B <sup>②</sup>
40	HGB1B040B <sup>②</sup>	HGB2B040B <sup>②</sup>	HGB3B040B <sup>②</sup>
45	HGB1B045B <sup>②</sup>	HGB2B045B <sup>②</sup>	HGB3B045B <sup>②</sup>
50	HGB1B050B <sup>②</sup>	HGB2B050B <sup>②</sup>	HGB3B050B <sup>②</sup>
60	HGB1B060B	HGB2B060B	HGB3B060B
70	HGB1B070B	HGB2B070B	HGB3B070B
80	HGB1B080B	HGB2B080B	HGB3B080B
90	HGB1B090B	HGB2B090B	HGB3B090B
100	HGB1B100B	HGB2B100B	HGB3B100B
110	HGB1B110B	HGB2B110B	HGB3B110B
125	HGB1B125B	HGB2B125B	HGB3B125B

## Type LGB<sup>®</sup> (Panelboard Mount)

Continuous Current Rating @ 40°C	1-Pole	2-Pole	3-Pole
	Catalog Number	Catalog Number	Catalog Number
15	LGB1B015B <sup>①②</sup>	LGB2B015B <sup>②</sup>	LGB3B015B <sup>②</sup>
20	LGB1B020B <sup>①②</sup>	LGB2B020B <sup>②</sup>	LGB3B020B <sup>②</sup>
25	LGB1B025B <sup>②</sup>	LGB2B025B <sup>②</sup>	LGB3B025B <sup>②</sup>
30	LGB1B030B <sup>②</sup>	LGB2B030B <sup>②</sup>	LGB3B030B <sup>②</sup>
35	LGB1B035B <sup>②</sup>	LGB2B035B <sup>②</sup>	LGB3B035B <sup>②</sup>
40	LGB1B040B <sup>②</sup>	LGB2B040B <sup>②</sup>	LGB3B040B <sup>②</sup>
45	LGB1B045B <sup>②</sup>	LGB2B045B <sup>②</sup>	LGB3B045B <sup>②</sup>
50	LGB1B050B <sup>②</sup>	LGB2B050B <sup>②</sup>	LGB3B050B <sup>②</sup>
60	LGB1B060B	LGB2B060B	LGB3B060B
70	LGB1B070B	LGB2B070B	LGB3B070B
80	LGB1B080B	LGB2B080B	LGB3B080B
90	LGB1B090B	LGB2B090B	LGB3B090B
100	LGB1B100B	LGB2B100B	LGB3B100B
110	LGB1B110B	LGB2B110B	LGB3B110B
125	LGB1B125B	LGB2B125B	LGB3B125B

## Shipping Weights

Number of Poles	Number per Carton	Shipping Weight lbs. (kg)
1	1	0.9 (0.4)
2	1	1.9 (0.9)
3	1	2.9 (1.2)

## Lugs for 60/75°C Wire

Type	Ampere Rating	Wire Size	Catalog Number
NGB HGB LGB	15-30A	#14-#6 AWG Cu	TC1Q1 (qty. 1)
		#12-#6 AWG Al	3TC1Q1 (qty. 3)
	35-125A	#8-1/0 AWG Cu	3TC1GG20
		#8-2/0 AWG Al	

## Interrupting Ratings (max. RMS symmetrical amperes kA)

	Poles	UL489							
		Volts AC						Volts DC	
		120	240	277	347	480Y/277	600Y/347	125	125/250
NGB	1	100	—	25	14	—	—	14	—
	2,3	—	100	—	—	25	14	—	14 <sup>④</sup>
HGB	1	100	—	35	14	—	—	14	—
	2,3	—	100	—	—	35	14	—	14 <sup>④</sup>
LGB	1	100	—	65	14	—	—	14	—
	2,3	—	100	—	—	65	14	—	14 <sup>④</sup>

① SWD rated.  
② HID rated.

③ 2-pole only.  
④ 2-pole only or two outer poles of 3-pole breaker  
⑤ UL Listed for reverse feed.

For external accessories, please refer to pages 7-142 to 7-147  
For internal accessories, please refer to page 7-33

# Molded Case Circuit Breakers

GB2 Frame

Selection

## Type NGB2<sup>⑤⑦</sup> (Panelboard Mount)

Continuous Current Rating @ 40°C	1-Pole	2-Pole	3-Pole
	Catalog Number	Catalog Number	Catalog Number
15	NGB1K015B <sup>①②</sup>	NGB2K015B <sup>②</sup>	NGB3K015B <sup>②</sup>
20	NGB1K020B <sup>①②</sup>	NGB2K020B <sup>②</sup>	NGB3K020B <sup>②</sup>
25	NGB1K025B <sup>②</sup>	NGB2K025B <sup>②</sup>	NGB3K025B <sup>②</sup>
30	NGB1K030B <sup>②</sup>	NGB2K030B <sup>②</sup>	NGB3K030B <sup>②</sup>
35	NGB1K035B <sup>②</sup>	NGB2K035B <sup>②</sup>	NGB3K035B <sup>②</sup>
40	NGB1K040B <sup>②</sup>	NGB2K040B <sup>②</sup>	NGB3K040B <sup>②</sup>
45	NGB1K045B <sup>②</sup>	NGB2K045B <sup>②</sup>	NGB3K045B <sup>②</sup>
50	NGB1K050B <sup>②</sup>	NGB2K050B <sup>②</sup>	NGB3K050B <sup>②</sup>
60	NGB1K060B	NGB2K060B	NGB3K060B
70	NGB1K070B	NGB2K070B	NGB3K070B
80	NGB1K080B	NGB2K080B	NGB3K080B
90	NGB1K090B	NGB2K090B	NGB3K090B
100	NGB1K100B	NGB2K100B	NGB3K100B
110	NGB1K110B	NGB2K110B	NGB3K110B
125	NGB1K125B	NGB2K125B	NGB3K125B



LGB3K125B

Load lugs are included as standard. HACR rated.

## Type HGB2<sup>⑤⑦</sup> (Panelboard Mount)

Continuous Current Rating @ 40°C	1-Pole	2-Pole	3-Pole
	Catalog Number	Catalog Number	Catalog Number
15	HGB1K015B <sup>①②</sup>	HGB2K015B <sup>②</sup>	HGB3K015B <sup>②</sup>
20	HGB1K020B <sup>①②</sup>	HGB2K020B <sup>②</sup>	HGB3K020B <sup>②</sup>
25	HGB1K025B <sup>②</sup>	HGB2K025B <sup>②</sup>	HGB3K025B <sup>②</sup>
30	HGB1K030B <sup>②</sup>	HGB2K030B <sup>②</sup>	HGB3K030B <sup>②</sup>
35	HGB1K035B <sup>②</sup>	HGB2K035B <sup>②</sup>	HGB3K035B <sup>②</sup>
40	HGB1K040B <sup>②</sup>	HGB2K040B <sup>②</sup>	HGB3K040B <sup>②</sup>
45	HGB1K045B <sup>②</sup>	HGB2K045B <sup>②</sup>	HGB3K045B <sup>②</sup>
50	HGB1K050B <sup>②</sup>	HGB2K050B <sup>②</sup>	HGB3K050B <sup>②</sup>
60	HGB1K060B	HGB2K060B	HGB3K060B
70	HGB1K070B	HGB2K070B	HGB3K070B
80	HGB1K080B	HGB2K080B	HGB3K080B
90	HGB1K090B	HGB2K090B	HGB3K090B
100	HGB1K100B	HGB2K100B	HGB3K100B
110	HGB1K110B	HGB2K110B	HGB3K110B
125	HGB1K125B	HGB2K125B	HGB3K125B

## Type LGB2<sup>⑤⑦</sup> (Panelboard Mount)

Continuous Current Rating @ 40°C	1-Pole	2-Pole	3-Pole
	Catalog Number	Catalog Number	Catalog Number
15	LGB1K015B <sup>①②</sup>	LGB2K015B <sup>②</sup>	LGB3K015B <sup>②</sup>
20	LGB1K020B <sup>①②</sup>	LGB2K020B <sup>②</sup>	LGB3K020B <sup>②</sup>
25	LGB1K025B <sup>②</sup>	LGB2K025B <sup>②</sup>	LGB3K025B <sup>②</sup>
30	LGB1K030B <sup>②</sup>	LGB2K030B <sup>②</sup>	LGB3K030B <sup>②</sup>
35	LGB1K035B <sup>②</sup>	LGB2K035B <sup>②</sup>	LGB3K035B <sup>②</sup>
40	LGB1K040B <sup>②</sup>	LGB2K040B <sup>②</sup>	LGB3K040B <sup>②</sup>
45	LGB1K045B <sup>②</sup>	LGB2K045B <sup>②</sup>	LGB3K045B <sup>②</sup>
50	LGB1K050B <sup>②</sup>	LGB2K050B <sup>②</sup>	LGB3K050B <sup>②</sup>
60	LGB1K060B	LGB2K060B	LGB3K060B
70	LGB1K070B	LGB2K070B	LGB3K070B
80	LGB1K080B	LGB2K080B	LGB3K080B
90	LGB1K090B	LGB2K090B	LGB3K090B
100	LGB1K100B	LGB2K100B	LGB3K100B
110	LGB1K110B	LGB2K110B	LGB3K110B
125	LGB1K125B	LGB2K125B	LGB3K125B

## Shipping Weights

Number of Poles	Number per Carton	Shipping Weight lbs. (kg)
1	1	.75 (.34)
2	1	1.3 (.59)
3	1	2.0 (.98)

## Lugs for 60/75°C Wire

Type	Ampere Rating	Wire Size	Catalog Number
NGB2 HGB2 LGB2	15-30A	#14-#6 AWG Cu	TC1Q1 (qty. 1)
		#12-#6 AWG Al	3TC1Q1 (qty. 3)
NGB2 HGB2 LGB2	35-125A	#8-1/0 AWG Cu	3TC1GG20
		#8-2/0 AWG Al	

## Interrupting Ratings (max. RMS symmetrical amperes kA)

Type	Poles	UL 489							
		Volts AC						Volts DC	
		120	240	277	480	347	600Y/347	125	125/250
NGB2	1	100	—	25	—	14	—	14	—
	2, 3	—	100	—	25	—	14	—	14 <sup>④</sup>
HGB2	1	100	—	35	—	22	—	14	—
	2, 3	—	100	—	35	—	22	—	14 <sup>④</sup>
LGB2	1	100	—	65	—	25	—	14	—
	2, 3	—	100	—	65	—	25	—	14 <sup>④</sup>

① SWD rated.

② HID rated.

③ 2-pole only.

④ 2-pole only or two outer poles of 3-pole breaker

⑤ Suitable for reverse feed applications

⑥ 3 pole breakers suitable for single phase applications

⑦ xGB2 breakers require different strap kits than xGB. Refer to Section 11 for specific catalog numbers.

For external accessories, please refer to pages 7-142 to 7-147  
For internal accessories, please refer to page 7-33



# Molded Case Circuit Breakers

## Accessories<sup>①</sup>

## Selection

### Shunt Trip

Control Voltage		Catalog Number
V AC	V DC	
120	—	CQDST120
240	—	CQDST240▲
277	—	CQDST277▲
480	—	CQDST480▲
600	—	CQDST600
—	12	CQDST12
—	24	CQDST24
—	48	CQDST48
—	125	CQDST125



CQDST120AAS

### Auxiliary Switch

Maximum Voltage		Number of Contacts	Catalog Number
AC	DC		
240	125	1A-1B	CQDA1
240	125	2A-2B	CQDA2

### Alarm Switch

Maximum Voltage		Catalog Number
AC	DC	
240	125	CQDBA

### Shunt Trip and Auxiliary Switch Combinations

Shunt Trip Voltage		Catalog Number
AC	DC	
24	—	CQDST24AAS▲
120	—	CQDST120AAS▲
240	—	CQDST240AAS▲
277	—	CQDST277AAS▲
480	—	CQDST480AAS▲
600	—	CQDST600AAS▲
—	12	CQDST12DAS▲
—	24	CQDST24DAS▲
—	48	CQDST48DAS▲
—	125	CQDST125DAS▲



CQD with Accessory Installed

### Alarm and Auxiliary Switch Combinations

For Breaker	Catalog Number
BQD, BQD6, CQD, CQD6, NGG, HGG, LGG, NGB, HGB, HGB, LGB, NGB2, HGB2 and LGB2	CQDA1BA▲

▲ Built to order. Allow 6-8 weeks for delivery.

① Adds 1-pole space for accessory.

# Circuit Breakers

Lug-In/Lug-Out with INSTA-WIRE

Selection

All BQ/BQH/HBQ circuit breakers are supplied with load side lugs. If line side lugs are required, add suffix "L" to catalog number. Consult Siemens for any additional charge. All standard circuit breakers are calibrated for 40°C maximum ambient application.

Continuous Current Rating @ 40° C	Type BQ <sup>①</sup>	Type BQH	Type HBQ
	10,000A IR Catalog Number	22,000A IR Catalog Number	65,000A IR Catalog Number

## 1-Pole (120/240V AC)<sup>⑤</sup>

Rating	Type BQ <sup>①</sup>	Type BQH	Type HBQ
15	BQ1B015 <sup>④</sup>	BQ1B015H <sup>④</sup>	HB1B015 <sup>④</sup>
20	BQ1B020 <sup>④</sup>	BQ1B020H <sup>④</sup>	HB1B020 <sup>④</sup>
25	BQ1B025	BQ1B025H	HB1B025
30	BQ1B030	BQ1B030H	HB1B030
35	BQ1B035	BQ1B035H	HB1B035
40	BQ1B040	BQ1B040H	HB1B040
45	BQ1B045	—	HB1B045
50	BQ1B050	BQ1B050H	HB1B050
60	BQ1B060 <sup>②</sup>	BQ1B060H	HB1B060
70	BQ1B070	BQ1B070H	HB1B070

## 2-Pole (Common-Trip 120/240V AC)<sup>⑥</sup>

Rating	Type BQ <sup>①</sup>	Type BQH	Type HBQ
15	BQ2B015	BQ2B015H	HB2B015
20	BQ2B020	BQ2B020H	HB2B020
25	BQ2B025	BQ2B025H	HB2B025
30	BQ2B030	BQ2B030H	HB2B030
35	BQ2B035	BQ2B035H	HB2B035
40	BQ2B040	BQ2B040H	HB2B040
45	BQ2B045	—	HB2B045
50	BQ2B050	BQ2B050H	HB2B050
60	BQ2B060 <sup>②</sup>	BQ2B060H	HB2B060
70	BQ2B070	BQ2B070H	HB2B070
80	BQ2B080	BQ2B080H	HB2B080
90	BQ2B090	BQ2B090H	HB2B090
100	BQ2B100	BQ2B100H	HB2B100
110	BQ2B110	—	HB2B110
125	BQ2B125	BQ2B125H	HB2B125

## 2-Pole (Common-Trip 240V AC)<sup>③⑥</sup>

Rating	Type BQ <sup>①</sup>	Type BQH	Type HBQ
15	BQ2H015	—	—
20	BQ2H020	—	—
30	BQ2H030	—	—
40	BQ2H040	—	—
50	BQ2H050	—	—
60	BQ2H060	—	—
70	BQ2H070	—	—
80	BQ2H080	—	—
90	BQ2H090	—	—
100	BQ2H100	—	—

## 3-Pole (Common-Trip 240V AC)<sup>⑦</sup>

Rating	Type BQ <sup>①</sup>	Type BQH	Type HBQ
15	BQ3B015	BQ3B015H	HB3B015
20	BQ3B020	BQ3B020H	HB3B020
25	BQ3B025	BQ3B025H	HB3B025
30	BQ3B030	BQ3B030H	HB3B030
35	BQ3B035	BQ3B035H	HB3B035
40	BQ3B040	BQ3B040H	HB3B040
45	BQ3B045	BQ3B045H	HB3B045
50	BQ3B050	BQ3B050H	HB3B050
60	BQ3B060	BQ3B060H	HB3B060
70	BQ3B070	BQ3B070H	HB3B070
80	BQ3B080	BQ3B080H	HB3B080
90	BQ3B090	BQ3B090H	HB3B090
100	BQ3B100	BQ3B100H	HB3B100

## BQ / BQH / HBQ Internal Accessories

Description	Catalog Number	Field/Factory Installed
120VAC Shunt Trip	add suffix...00S01	Factory
24VAC Shunt Trip	add suffix...00S07	Factory
120V Auxiliary Switch	add suffix...01 <sup>②</sup>	Factory

■ Built to order. Allow 2-3 weeks for delivery  
 ① UL Listed for use with 60/75° wire through 40 amps, UL listed for use with 75° wire only for 50 amps and above, HACR rated.

② 1A and 1B contacts.  
 ③ UL Listed for use on 3-phase grounded "B" systems — 10,000 for this application.  
 ④ UL Listed for frequent switching applications (SWD). 120V AC Fluorescent Lighting.

⑤ Shipped 12 per sleeve.  
 ⑥ Shipped 6 per sleeve.  
 ⑦ Shipped 4 per sleeve.  
 ⑧ UL Listed 5KA IR.  
 ⑨ Refer to Table A on page 7-135

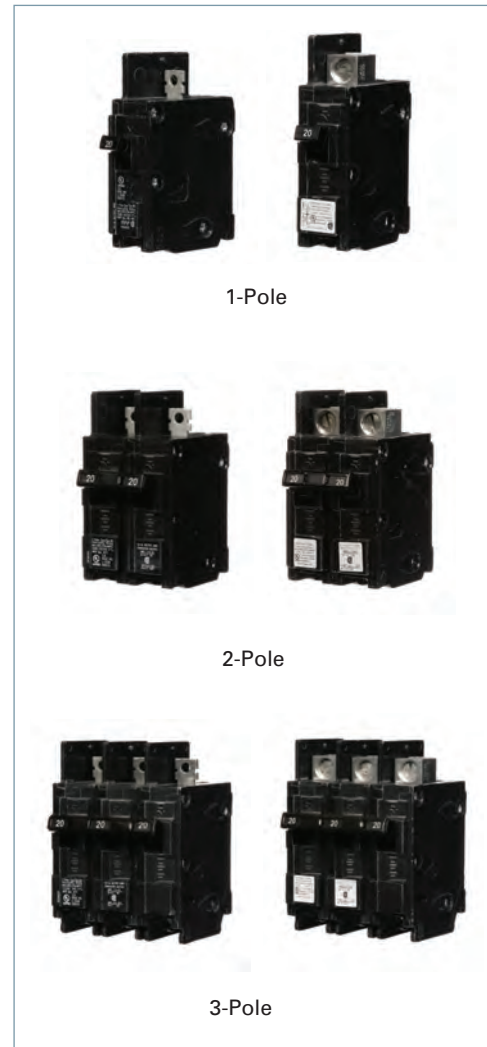

## Factory Modifications

Description	Catalog Number
Line Side Lugs	add suffix...L
Quick Connect Lug	add suffix...QX
400Hz Calibration	add suffix...Y <sup>⑧</sup>
Marine 50° C Ambient Calibration	add suffix...M
Fungus Proofing	add suffix...F

For external accessories, please refer to page 7-140

# Molded Case Circuit Breakers

## DIN Rail Mounted Circuit Breakers

## Selection/Dimensions

Breaker Type	Ampere Rating	Catalog Number	Line Side Connector	Load Side Connector	Interrupting Ratings (KA) (RMS Symmetrical Amperes) Volts AC	
					120	120/240

### 1-Pole DIN Rail (120/240V AC)

<b>BQLD</b> 1-Pole 120V DIN Rail	10	BQ1B010QLD	TC1Q1	TC1Q1	10	
	15	BQ1B015QLD	TC1Q1	TC1Q1	10	
	20	BQ1B020QLD	TC1Q1	TC1Q1	10	
	25	BQ1B025QLD	TC1Q1	TC1Q1	10	
	30	BQ1B030QLD	TC1Q1	TC1Q1	10	
	35	BQ1B035QLD	TC1Q1	TC1Q1	10	
	40	BQ1B040QLD	TC1Q1	TC1Q1	10	
<b>BQXD</b> 1-Pole 120V DIN Rail	45	BQ1B045QLD	TA1Q1	TA1Q1	10	
	50	BQ1B050QLD	TA1Q1	TA1Q1	10	
	60	BQ1B060QLD	TA1Q1	TA1Q1	10	
	10	BQ1B010QXD	TC1Q1	Quick-Connect	10	
	15	BQ1B015QXD	TC1Q1	Quick-Connect	10	
	20	BQ1B020QXD	TC1Q1	Quick-Connect	10	
	25	BQ1B025QXD	TC1Q1	Quick-Connect	10	
30	BQ1B030QXD	TC1Q1	Quick-Connect	10		
<b>BQXD</b> 2-Pole 120/240V DIN Rail	35	BQ1B035QXD	TC1Q1	Quick-Connect	10	
	40	BQ1B040QXD	TC1Q1	Quick-Connect	10	
	45	BQ1B045QXD	TA1Q1	Quick-Connect	10	
	50	BQ1B050QXD	TA1Q1	Quick-Connect	10	
	60	BQ1B060QXD	TA1Q1	Quick-Connect	10	

### 2-Pole DIN Rail (120/240V AC)

<b>BQLD</b> 2-Pole 120/240V DIN Rail	10	BQ2B010QLD	TC1Q1	TC1Q1		10
	15	BQ2B015QLD	TC1Q1	TC1Q1		10
	20	BQ2B020QLD	TC1Q1	TC1Q1		10
	25	BQ2B025QLD	TC1Q1	TC1Q1		10
	30	BQ2B030QLD	TC1Q1	TC1Q1		10
	35	BQ2B035QLD	TC1Q1	TC1Q1		10
	40	BQ2B040QLD	TC1Q1	TC1Q1		10
<b>BQXD</b> 2-Pole 120/240V DIN Rail	45	BQ2B045QLD	TA1Q1	TA1Q1		10
	50	BQ2B050QLD	TA1Q1	TA1Q1		10
	60	BQ2B060QLD	TA1Q1	TA1Q1		10
	10	BQ2B010QXD	TC1Q1	Quick-Connect		10
	15	BQ2B015QXD	TC1Q1	Quick-Connect		10
	20	BQ2B020QXD	TC1Q1	Quick-Connect		10
	25	BQ2B025QXD	TC1Q1	Quick-Connect		10
<b>BQXD</b> 2-Pole 120/240V DIN Rail	30	BQ2B030QXD	TC1Q1	Quick-Connect		10
	35	BQ2B035QXD	TC1Q1	Quick-Connect		10
	40	BQ2B040QXD	TC1Q1	Quick-Connect		10
	45	BQ2B045QXD	TA1Q1	Quick-Connect		10
	50	BQ2B050QXD	TA1Q1	Quick-Connect		10
	60	BQ2B060QXD	TA1Q1	Quick-Connect		10

### Lugs-For Use with BQXD<sup>®</sup>

Circuit Breaker Amp. Rtg.	Cab. Per Lug	Lug Wire Range AWG	Catalog Number
<b>Line Side</b>			
10-40	1	#16-#6 Cu	TC1Q1 <sup>①②</sup>
	1	#12-#6 Al	
45-125	1	#8-#1 Cu	TA1Q1
	1	#6-#1/0 Al	

### Finger Safe Terminal Shield

Protects against accidental contact with lugs-1 per lug. Fits line and load end.

Catalog Number	Qty
BQFS2	2
BQFS1K	1000

### Enclosures

Type	Catalog Number <sup>③</sup>
1	EB3100S <sup>③⑤</sup>
3R	WB3100

For inches / millimeters conversion, see Application Data section.

■ Built to order. Allow 2-3 weeks for delivery.

① UL Listed for use with 60/75° wire through 40 amps.  
UL listed for use with 75° wire only for 50 amps and above, HACR rated.

② Connector has steel construction.

③ Surface mounted indoor. If flush mounting is required, replace suffix "S" in catalog number with suffix "F".

④ Neutral included in enclosure.

⑤ Enclosure will not accept circuit breakers with shunt trips or auxiliary switches installed.

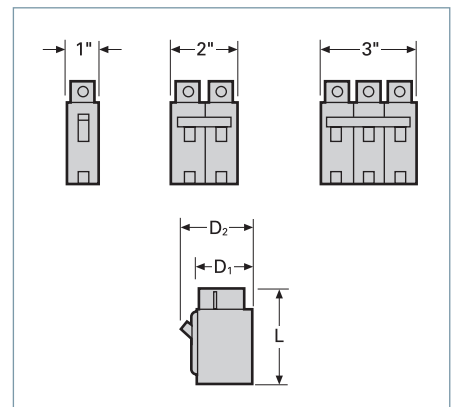
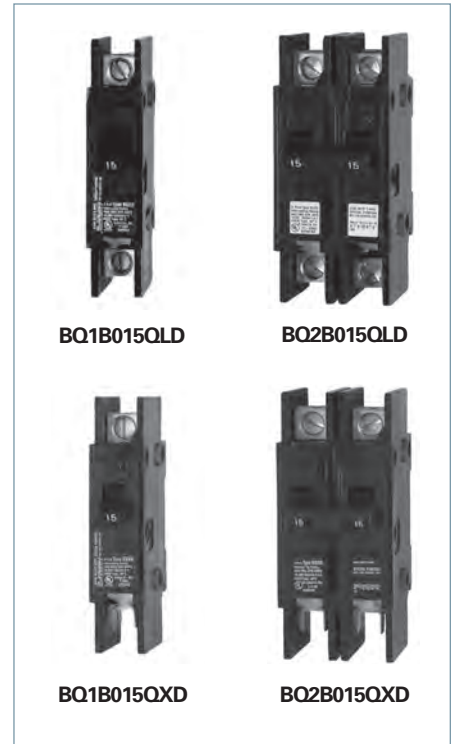

Breaker Type	Amperes	Dimensions (inches)		
		L	D1	D2
BQ, BQH	15-50	3¾	2¾	3
BQ, BQH	55-125	4	2¾	3
HBO	15-125	4	2¾	3
BQXD	15-60	4½	2¾	3

⑥ Type BQXD uses TA1Q1 or TC1Q1 lugs on line side of circuit breaker.

Enclosures, see Section 6  
For external accessories, please refer to pages 7-140, 7-142 to 7-147

# Molded Case Circuit Breakers

QR 250A Frame

Selection/Dimensions

Continuous Current Rating @ 40°C	2-Pole 240V AC Catalog Number	3-Pole 240V AC Catalog Number
----------------------------------	-------------------------------	-------------------------------

## Type QR2<sup>②</sup>

100	QR22B100	QR23B100
125	QR22B125	QR23B125
150	QR22B150	QR23B150
175	QR22B175	QR23B175
200	QR22B200	QR23B200
225	QR22B225	QR23B225
250	QR22B250	QR23B250

## Type QRH2<sup>②</sup>

100	QRH22B100■	QRH23B100
125	QRH22B125	QRH23B125
150	QRH22B150	QRH23B150
175	QRH22B175■	QRH23B175
200	QRH22B200	QRH23B200
225	QRH22B225	QRH23B225
250	QRH22B250	QRH23B250

## Type HQR2<sup>②</sup>

100	HQR22B100■	HQR23B100
125	HQR22B125	HQR23B125
150	HQR22B150	HQR23B150
175	HQR22B175■	HQR23B175
200	HQR22B200	HQR23B200
225	HQR22B225	HQR23B225
250	HQR22B250	HQR23B250

## Type HQR2H<sup>②</sup>

100	HQR22B100H	HQR23B100H
125	HQR22B125H	HQR23B125H
150	HQR22B150H	HQR23B150H
175	HQR22B175H	HQR23B175H
200	HQR22B200H	HQR23B200H
225	HQR22B225H	HQR23B225H
250	HQR22B250H	HQR23B250H

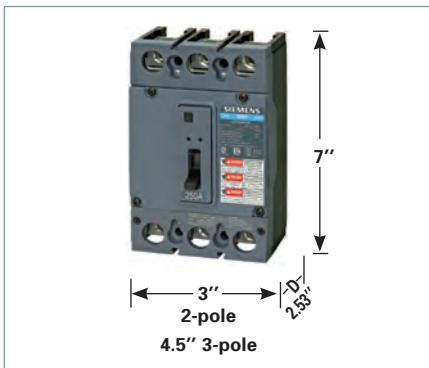

■ Built to order. Allow 2-3 weeks for delivery.

② See **Note: A** page 7-129.

**Note:** QR breakers are UL Listed for reverse feed applications.

③ HACR rated.

## Ordering Information

Load side 3TA1QR300 lugs are mounted and included when circuit breaker is ordered. For line and load lugs (3TA1QR300) installed at no additional charge, add suffix "L" to catalog number.

**50°C Calibration** - See page 7-138.

**400HZ** - See page 7-138.

## Shipping Weights

Number of Poles	Number per Carton	Shipping Weight (lbs.)
2	1	3.2
3	1	4.5

## Lugs For 75°C Wire<sup>①</sup>

Catalog Number	Lug Body	Lug Wire Range
3TA1QR300	Al	#3 - 300 Kcmil Al/Cu
3TC1QR250	Cu	#3 - 300 Kcmil Cu ONLY
CCQ250	CMP	#6 AWG - 350kcmil Al/Cu

## Enclosures (Neutral Included)

Type	Catalog Number
1	QR2N1(S) or (F)
3R	QR2N3R3
12	QR2N12
4X	QR2N4X
4X316	QR2N4X316

## UL 489 Interrupting Ratings

Breaker Type	RMS Symmetrical Amperes (kA) Volts AC (50/60 Hz)
	240
QR2	10
QRH2	25
HQR2	65
HQR2H	100

Enclosures Section 6  
For external accessories, please refer to pages 7-142 to 7-147

# Molded Case Circuit Breakers

QR Accessories

Selection

## Shunt Trip

Control Voltage		In Rush	Shunt Trip	Shunt Trip and Auxiliary Switch Combination
AC	DC		Catalog Number	Catalog Number
—	24	1.1A	S07QR2	S07QR2A
120 - 240	48	2.0A AC / 1.8A DC	S01QR2	S01QR2A

## Auxiliary Switch

Contains (1) or (2) sets of "A" contacts and "B" contacts

Maximum Control Supply Voltage (V)	Maximum Allowable Current (A)	Single Auxiliary 1A - 1B Contact Catalog Number	Double Auxiliary 2A - 2B Contact Catalog Number
250 AC / 125 DC	5 AC / 0.5 DC	A01QR2	A02QR2

## External Accessories

Description	Catalog Number
Padlock Device	HPLQR
Mounting Screw Kit	MSQR3
Handle Blocking Device	HBLQR
Handle Sliding-bar Interlock	SBMIQR

Padlock Device HPLQR



Handle Block Device HBLQR



Mechanical Interlock SBMIQR



# Molded Case Circuit Breakers

CQD 100A Frame

Selection/Dimensions

## Type CQD (Cable In - Cable Out) DIN Rail Mount<sup>③</sup>

Continuous Current Rating @ 40°C	1-Pole	2-Pole	3-Pole
	277V AC 125V DC	480Y/277V AC 125/250V DC	480Y/277V AC
	Catalog Number	Catalog Number	Catalog Number
15	CQD115 <sup>①②</sup>	CQD215 <sup>②</sup>	CQD315 <sup>②</sup>
20	CQD120 <sup>①②</sup>	CQD220 <sup>②</sup>	CQD320 <sup>②</sup>
25	CQD125 <sup>②</sup>	CQD225 <sup>②</sup>	CQD325 <sup>②</sup>
30	CQD130 <sup>②</sup>	CQD230 <sup>②</sup>	CQD330 <sup>②</sup>
35	CQD135 <sup>②</sup> ■	CQD235 <sup>②</sup> ■	CQD335 <sup>②</sup>
40	CQD140 <sup>②</sup> ■	CQD240 <sup>②</sup>	CQD340 <sup>②</sup>
45	CQD145 <sup>②</sup> ■	CQD245 <sup>②</sup> ■	CQD345 <sup>②</sup> ■
50	CQD150 <sup>②</sup> ■	CQD250 <sup>②</sup>	CQD350 <sup>②</sup>
60	CQD160■	CQD260	CQD360
70	CQD170■	CQD270	CQD370
80	CQD180■	CQD280	CQD380
90	CQD190■	CQD290■	CQD390
100	CQD1100■	CQD2100	CQD3100

## Shipping Weights

Number of Poles	Number per Carton	Shipping Weight lbs. (kg)
1	1	0.5 (0)
2	1	1.0 (0)
3	1	1.5 (1)

## Lugs For 60/75°C Wire

Amps	Wire Size
15-40	#14-#6 AWG Cu #12-#6 AWG Al
45-100	#8-#1 AWG Cu #6-#1/0 AWG Al

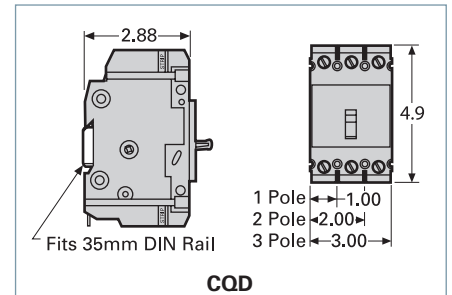
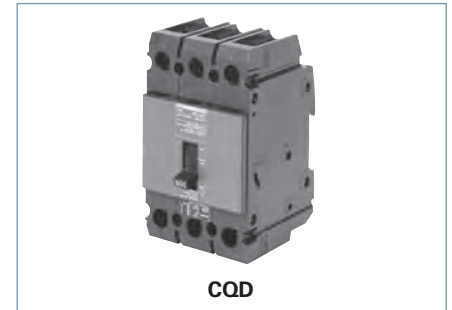

## Interrupting Ratings (max. RMS symmetrical amperes kA)

Breaker Type	Number of Poles	UL						IEC 947-2 <sup>②</sup>				
		Volts AC						Volts AC				
		120			240			220/240		380/415		
		120	240	277	480/277	600/347	125/250	I <sub>cu</sub>	I <sub>cs</sub>	I <sub>cu</sub>	I <sub>cs</sub>	
CQD	1-Pole	65	—	14	—	—	14	—	18	9	—	—
	2-Pole	—	65	—	14	—	—	14	65	33	18	9
	3-Pole	—	65	—	14	—	—	14	65	33	18	9

For inches / millimeters conversion, see Application Data section.

■ Built to order. Allow 2-3 weeks for delivery.

① SWD rated.

Note: CQD breakers are UL Listed for reverse feed applications.

② HID rated.

③ HACR rated.

④ Applicable for 15-30A breakers only.

Enclosures Section 6  
Accessories pages 7-40 and 7-142 to 7-147

# Molded Case Circuit Breakers

GG 125A Frame

Selection/Dimensions

## Type NGG (Cable In - Cable Out)

Continuous Current Rating @ 40°C	1-Pole	2-Pole	3-Pole
	Catalog Number	Catalog Number	Catalog Number
15	NGG1B015L <sup>①②</sup>	NGG2B015L <sup>②</sup>	NGG3B015L <sup>②</sup>
20	NGG1B020L <sup>①②</sup>	NGG2B020L <sup>②</sup>	NGG3B020L <sup>②</sup>
25	NGG1B025L <sup>②</sup>	NGG2B025L <sup>②</sup>	NGG3B025L <sup>②</sup>
30	NGG1B030L <sup>②</sup>	NGG2B030L <sup>②</sup>	NGG3B030L <sup>②</sup>
35	NGG1B035L <sup>②</sup>	NGG2B035L <sup>②</sup>	NGG3B035L <sup>②</sup>
40	NGG1B040L <sup>②</sup>	NGG2B040L <sup>②</sup>	NGG3B040L <sup>②</sup>
45	NGG1B045L <sup>②</sup>	NGG2B045L <sup>②</sup>	NGG3B045L <sup>②</sup>
50	NGG1B050L <sup>②</sup>	NGG2B050L <sup>②</sup>	NGG3B050L <sup>②</sup>
60	NGG1B060L	NGG2B060L	NGG3B060L
70	NGG1B070L	NGG2B070L	NGG3B070L
80	NGG1B080L	NGG2B080L	NGG3B080L
90	NGG1B090L	NGG2B090L	NGG3B090L
100	NGG1B100L	NGG2B100L	NGG3B100L
110	NGG1B110L	NGG2B110L	NGG3B110L
125	NGG1B125L	NGG2B125L	NGG3B125L



GG

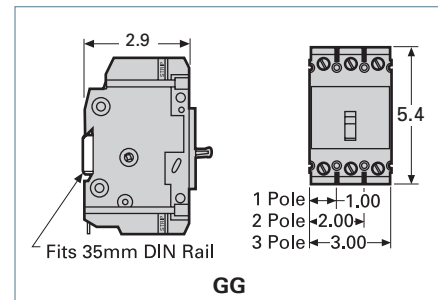

GG

Line and load lugs are included as standard. If no lugs are required, remove the "L" suffix. HACR rated. Suitable for screws or DIN rail mounting.

## Type HGG (Cable In - Cable Out)

Continuous Current Rating @ 40°C	1-Pole	2-Pole	3-Pole
	Catalog Number	Catalog Number	Catalog Number
15	HGG1B015L <sup>①②</sup>	HGG2B015L <sup>②</sup>	HGG3B015L <sup>②</sup>
20	HGG1B020L <sup>①②</sup>	HGG2B020L <sup>②</sup>	HGG3B020L <sup>②</sup>
25	HGG1B025L <sup>②</sup>	HGG2B025L <sup>②</sup>	HGG3B025L <sup>②</sup>
30	HGG1B030L <sup>②</sup>	HGG2B030L <sup>②</sup>	HGG3B030L <sup>②</sup>
35	HGG1B035L <sup>②</sup>	HGG2B035L <sup>②</sup>	HGG3B035L <sup>②</sup>
40	HGG1B040L <sup>②</sup>	HGG2B040L <sup>②</sup>	HGG3B040L <sup>②</sup>
45	HGG1B045L <sup>②</sup>	HGG2B045L <sup>②</sup>	HGG3B045L <sup>②</sup>
50	HGG1B050L <sup>②</sup>	HGG2B050L <sup>②</sup>	HGG3B050L <sup>②</sup>
60	HGG1B060L	HGG2B060L	HGG3B060L
70	HGG1B070L	HGG2B070L	HGG3B070L
80	HGG1B080L	HGG2B080L	HGG3B080L
90	HGG1B090L	HGG2B090L	HGG3B090L
100	HGG1B100L	HGG2B100L	HGG3B100L
110	HGG1B110L	HGG2B110L	HGG3B110L
125	HGG1B125L	HGG2B125L	HGG3B125L

## Type LGG (Cable In - Cable Out)

Continuous Current Rating @ 40°C	1-Pole	2-Pole	3-Pole
	Catalog Number	Catalog Number	Catalog Number
15	LGG1B015L <sup>①②</sup>	LGG2B015L <sup>②</sup>	LGG3B015L <sup>②</sup>
20	LGG1B020L <sup>①②</sup>	LGG2B020L <sup>②</sup>	LGG3B020L <sup>②</sup>
25	LGG1B025L <sup>②</sup>	LGG2B025L <sup>②</sup>	LGG3B025L <sup>②</sup>
30	LGG1B030L <sup>②</sup>	LGG2B030L <sup>②</sup>	LGG3B030L <sup>②</sup>
35	LGG1B035L <sup>②</sup>	LGG2B035L <sup>②</sup>	LGG3B035L <sup>②</sup>
40	LGG1B040L <sup>②</sup>	LGG2B040L <sup>②</sup>	LGG3B040L <sup>②</sup>
45	LGG1B045L <sup>②</sup>	LGG2B045L <sup>②</sup>	LGG3B045L <sup>②</sup>
50	LGG1B050L <sup>②</sup>	LGG2B050L <sup>②</sup>	LGG3B050L <sup>②</sup>
60	LGG1B060L	LGG2B060L	LGG3B060L
70	LGG1B070L	LGG2B070L	LGG3B070L
80	LGG1B080L	LGG2B080L	LGG3B080L
90	LGG1B090L	LGG2B090L	LGG3B090L
100	LGG1B100L	LGG2B100L	LGG3B100L
110	LGG1B110L	LGG2B110L	LGG3B110L
125	LGG1B125L	LGG2B125L	LGG3B125L

## Shipping Weights

Number of Poles	Number per Carton	Shipping Weight lbs. (kg)
1	1	.75 (0.34)
2	1	1.3 (0.59)
3	1	2.0 (0.98)

## Lugs For 60/75°C Wire

NGG		
Ampere Rating	Wire Size	Catalog Number
15-30A	#14-#6 AWG Cu	TC1Q1 (qty. 1)
	#12-#6 AWG Al	3TC1Q1 (qty. 3)
35-125A	#8-1/0 AWG Cu #8-2/0 AWG Al	3TC1GG20 (qty. 3)
15-125A	Nut Keeper plate w/ screw (for crimp terminals)	TNKG3 (qty. 3)

## Interrupting Ratings (max. RMS symmetrical amperes kA)

Breaker Type	Poles	UL489 Volts AC							IEC 60947-2 (Ics = 50%Icu)				
		Volts AC							Volts DC		Volts AC		Volts DC
		120	240	277	347	480	600Y/347	125	125/250	240	415	125/250	
NGG	1	65	—	25	14	—	—	14	—	25	—	—	
	2,3	—	65	—	—	25	14	—	14 <sup>①</sup>	65	—	14	
HGG	1	—	—	35	22	—	—	14	—	—	—	—	
	2,3	—	—	—	—	35	22	—	14 <sup>①</sup>	—	—	—	
LGG	1	—	—	65	25	—	—	14	—	—	—	—	
	2,3	—	—	—	—	65	25	—	14 <sup>①</sup>	—	—	—	

For inches / millimeters conversion, see Application Data section.

① SWD rated.

② HID rated at 15-50A 1-pole @ 277 VAC; 2 & 3-pole @ 480 VAC

Enclosures Section 6  
Accessories pages 7-40 and 7-142 to 7-147

# Molded Case Circuit Breakers

Accessories<sup>①</sup>

Selection

## Shunt Trip

Control Voltage		BQD, BQD6, CQD, NGG, HGG, LGG, NGB, HGB and LGB Catalog Number
V AC	V DC	
120	—	CQDST120
240	—	CQDST240▲
277	—	CQDST277▲
480	—	CQDST480▲
600	—	CQDST600
—	12	CQDST12
—	24	CQDST24
—	48	CQDST48
—	125	CQDST125



## Auxiliary Switch

Maximum Voltage		Number of Contacts	BQD, BQD6, CQD, NGG, HGG, LGG, NGB, HGB and LGB Catalog Number
AC	DC		
240	125	1A-1B	CQDA1
240	125	2A-2B	CQDA2

## Alarm Switch

Maximum Voltage		BQD, BQD6, CQD, NGG, HGG, LGG, NGB, HGB and LGB Catalog Number
AC	DC	
240	125	CQDBA



## Shunt Trip and Auxiliary Switch Combinations

Shunt Trip Voltage		BQD, BQD6, CQD, NGG, HGG, LGG, NGB, HGB and LGB Catalog Number
AC	DC	
24	—	CQDST24AAS▲
120	—	CQDST120AAS▲
240	—	CQDST240AAS▲
277	—	CQDST277AAS▲
480	—	CQDST480AAS▲
600	—	CQDST600AAS▲
—	12	CQDST12DAS▲
—	24	CQDST24DAS▲
—	48	CQDST48DAS▲
—	125	CQDST125DAS▲

## Alarm and Auxiliary Switch Combinations

For Breaker	Catalog Number
BQD, BQD6, CQD, NGG, HGG, LGG, NGB, HGB and LGB	CQDA1BA▲

▲ Built to order. Allow 6-8 weeks for delivery.

① Adds 1-pole space for accessory.



# Molded Case Circuit Breakers

EG 125A Frame

Selection/Dimensions

## Type NEG (Cable In - Cable Out)

Continuous Ampere Rating @ 40°C	1-Pole	2-Pole	3-Pole	4-Pole
	Catalog Number	Catalog Number	Catalog Number	Catalog Number
15	NEG1B015L <sup>①②</sup>	NEG2B015L <sup>②</sup>	NEG3B015L	NEG4B015L
20	NEG1B020L <sup>①②</sup>	NEG2B020L <sup>②</sup>	NEG3B020L	NEG4B020L
25	NEG1B025L <sup>②</sup>	NEG2B025L <sup>②</sup>	NEG3B025L	NEG4B025L
30	NEG1B030L <sup>②</sup>	NEG2B030L <sup>②</sup>	NEG3B030L	NEG4B030L
35	NEG1B035L <sup>②</sup>	NEG2B035L <sup>②</sup>	NEG3B035L	NEG4B035L
40	NEG1B040L <sup>②</sup>	NEG2B040L <sup>②</sup>	NEG3B040L	NEG4B040L
45	NEG1B045L <sup>②</sup>	NEG2B045L <sup>②</sup>	NEG3B045L	NEG4B045L
50	NEG1B050L <sup>②</sup>	NEG2B050L <sup>②</sup>	NEG3B050L	NEG4B050L
60	NEG1B060L	NEG2B060L	NEG3B060L	NEG4B060L
70	NEG1B070L	NEG2B070L	NEG3B070L	NEG4B070L
80	NEG1B080L	NEG2B080L	NEG3B080L	NEG4B080L
90	NEG1B090L	NEG2B090L	NEG3B090L	NEG4B090L
100	NEG1B100L	NEG2B100L	NEG3B100L	NEG4B100L
110	NEG1B110L	NEG2B110L	NEG3B110L	NEG4B110L
125	NEG1B125L	NEG2B125L	NEG3B125L	NEG4B125L

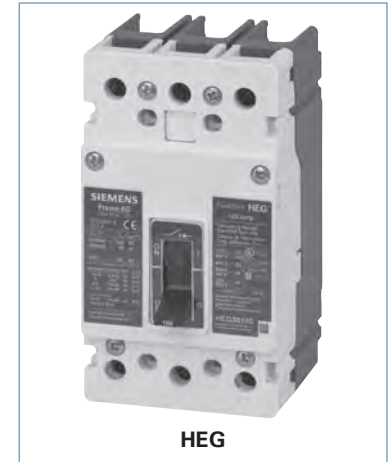

## Type HEG (Cable In - Cable Out)

Continuous Ampere Rating @ 40°C	1-Pole	2-Pole	3-Pole	4-Pole
	Catalog Number	Catalog Number	Catalog Number	Catalog Number
15	HEG1B015L <sup>①②</sup>	HEG2B015L <sup>②</sup>	HEG3B015L	HEG4B015L
20	HEG1B020L <sup>①②</sup>	HEG2B020L <sup>②</sup>	HEG3B020L	HEG4B020L
25	HEG1B025L <sup>②</sup>	HEG2B025L <sup>②</sup>	HEG3B025L	HEG4B025L
30	HEG1B030L <sup>②</sup>	HEG2B030L <sup>②</sup>	HEG3B030L	HEG4B030L
35	HEG1B035L <sup>②</sup>	HEG2B035L <sup>②</sup>	HEG3B035L	HEG4B035L
40	HEG1B040L <sup>②</sup>	HEG2B040L <sup>②</sup>	HEG3B040L	HEG4B040L
45	HEG1B045L <sup>②</sup>	HEG2B045L <sup>②</sup>	HEG3B045L	HEG4B045L
50	HEG1B050L <sup>②</sup>	HEG2B050L <sup>②</sup>	HEG3B050L	HEG4B050L
60	HEG1B060L	HEG2B060L	HEG3B060L	HEG4B060L
70	HEG1B070L	HEG2B070L	HEG3B070L	HEG4B070L
80	HEG1B080L	HEG2B080L	HEG3B080L	HEG4B080L
90	HEG1B090L	HEG2B090L	HEG3B090L	HEG4B090L
100	HEG1B100L	HEG2B100L	HEG3B100L	HEG4B100L
110	HEG1B110L	HEG2B110L	HEG3B110L	HEG4B110L
125	HEG1B125L	HEG2B125L	HEG3B125L	HEG4B125L

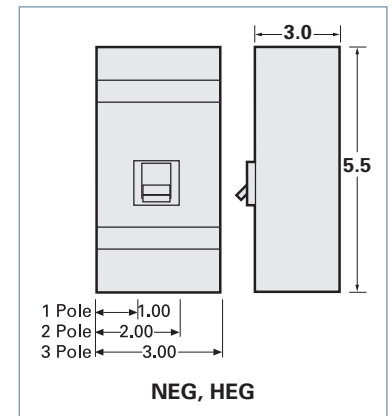

Line and load lugs are included as standard.  
HACR rated.  
Suitable for screw mounting.

## Shipping Weights

Number of Poles	Number per Carton	Shipping Weight lbs. (kg)
1	1	1.1 (0.5)
2	1	2.0 (0.9)
3	1	3.1 (1.4)
4	1	3.9 (1.8)

## Lugs For 60/75°C Wire

NEG/HEG		
Ampere Rating	Wire Size	Catalog Number
15-125A	#14 - 3/0 AWG Cu (steel lugs)	3TW1EG30 (qty. 3)
15-125A <sup>②</sup>	#14 - 1/0 AWG Cu #14 - 1/0 AWG Al	3TA1EG10 (qty. 3)
15-125A <sup>②</sup>	#6 - 3/0 AWG Cu #6 - 3/0 AWG Al	3TA1EG30 (qty. 3)
15-125A	Nut Keeper plate w/ screw (for crimp terminals)	TNKE3 (3-Pole) TNKE4 (4-Pole)

## Interrupting Ratings

Breaker Type	Number of Poles	UL 489 AIR						IEC 60947-2						
		RMS Symmetrical Amperes (KA)						Volts AC (50/60Hz)						
		Volts AC(50/60Hz)			Volts DC			220/240		380/415		Volts DC		
		240	277	347	480	600/347	125	125/250	Icu	Ics	Icu	Ics	125	125/250
NEG	1	85	35	22	—	—	35	—	85	43	—	—	35	—
	2, 3, 4	85	—	—	35	22 <sup>③</sup>	—	35	85	43	40	20	—	35
HEG	1	100	65	25	—	—	42	—	100	50	—	—	42	—
	2, 3, 4	100	—	—	65	25 <sup>③</sup>	—	42	100	50	70	35	—	42

For inches / millimeters conversion, see Application Data section.

① SWD rated.  
② HID rated 277 VAC.

③ Applies to 3 & 4-pole breakers only.  
④ Optional lugs for NEG and HEG breakers.

Accessories pages 7-42 and 7-142 to 7-147

# Molded Case Circuit Breakers

Internal Accessories for NEG and HEG 125A Frame

Selection

## Shunt Trip

Control Voltage		NEG, HEG, NEB, HEB Catalog Number
V AC	V DC	
110-240	—	STRER240A
—	125	STRED125D
380-600	—	STREV600
24-60	24-60	STREM60D

## Auxiliary Switch

Maximum Voltage		Number of Contacts	NEG, HEG, NEB, HEB Catalog Number
AC	DC		
240	125	1A-1B	ASKE2
240	125	2A-2B	ASKE3

## Alarm Switch

Maximum Voltage		Number of Contacts	NEG, HEG, NEB, HEB Catalog Number
AC	DC		
240	125	1A-1B	ASKE1
240	125	2A-2B	ASKE5

## Undervoltage Trip

Control Voltage		NEG, HEG, NEB, HEB Catalog Number
AC	DC	
24		UVREB24A
60		UVREM60▲
120		UVREN120
240		UVRER240
480		UVREU480▲
600		UVREV600▲
	24	UVREB24D
	48	UVREC48D▲
	125	UVRED125D▲
	250	UVREE250D▲

## Alarm and Auxiliary Switch Combinations

For Breaker	Catalog Number
NEG, HEG	ASKE6

▲ Built to order. Allow 6-8 weeks for delivery.

# 3VA Molded Case Circuit Breakers

3VA UL Breakers

Catalog Numbering

## 3VA Catalog Numbering System

**Breaker Designation**

Breaker Designation	Suffix
Thermal magnetic trip breakers panelboard breakers	4
Thermal magnetic trip breakers general purpose breakers (Cable-in Cable-out)	5
Electronic trip breakers advance purpose breakers	6

**Suffix Rated Current**

Suffix	3VA51	3VA52	3VA61	3VA62	3VA63	3VA64
95	15A					
20	20A	200A				
22		225A				
25	25A	250A		250A	250A	250A
30	30A					
35	35A					
40	40A		40A		400A	400A
45	45A					
50	50A					
60	60A					600A
70	70A					
80	80A					
90	90A					
10	100A	100A	100A	100A		
11	110A	110A				
12	125A	125A				
15		150A	150A			
17		175A				

Frame Size	Suffix
125/150A	1
250A	2
400A	3
600A	4

No. of Poles	Suffix
1 pole	1
2 pole	2
3 pole	3
4 pole	4

3VA

6

2

25

-

5

KQ

3

1

-

0

A

A

0

**Interrupting Capacity @ 480V**

3VA5	3VA6	Suffix
MCP/MCS		0
MCP/MCS	MCP/MCS	1
IEC		2
IEC		3
25kA		4
35kA	35kA	5
65kA	65kA	6
100kA	100kA	7
	150kA	8

**Connection Technology**

Connection Technology	Suffix
blank, punched copper bar without any lug	1

**Auxiliary/Alarm switches**

Suffix	Auxiliary/Alarm switches
A	Without

**Auxiliary Releases**

Suffix	Auxiliary Releases
A	Without

**Protection Functions**

3VA5	L	I	N	Suffix
TM230	fix	adj		EC
TM210	fix	fix		ED
TM240	adj	adj		EF
TM230	fix	adj	100%	GC
TM210	fix	fix	100%	GD
TM240	adj	adj	100%	GF
TM110M		fix		MG
TM120M		adj		MH
TM120M		adj		MU
MCS110		fix		BB

**Protection Functions**

3VA6	L	S	I	G	N	LCD	com.	measurement values	Suffix
ETU230 LI	adj		adj		0%/50%/100%				HL
ETU330 LIG	adj		adj	adj	0%/50%/100%				HM
ETU350 LSI	adj	adj	fix		0%/50%/100%				HN
ETU550 LSI	adj	adj	adj		20/40%...100/160%	✓	✓	standard	JP
ETU556 LSI(G)	adj	adj	adj	alarm	20/40%...100/160%	✓	✓	standard	JT
ETU560 LSIG	adj	adj	adj	adj	20/40%...100/160%	✓	✓	standard	JQ
ETU820 LI	adj		adj		20/40%...100/160%	✓	✓	advanced	KL
ETU830 LIG	adj		adj	adj	20/40%...100/160%	✓	✓	advanced	KM
ETU850 LSI	adj	adj	adj		20/40%...100/160%	✓	✓	advanced	KP
ETU856 LSI(G)	adj	adj	adj	alarm	20/40%...100/160%	✓	✓	advanced	KT
ETU860 LSIG	adj	adj	adj	adj	20/40%...100/160%	✓	✓	advanced	KQ
ETU310M			adj						MS
MCS110			fix						BB

\*N – Neutral Protection  
 TMTU/ETU3... only 4 pole breakers  
 ETU5.../8.... 3 pole breakers with external CT for N-pole and all 4-pole breakers

**Regional Specifics (as appl.)**

Regional Specifics (as appl.)	Suffix
Standard	0
NAVAL/50°C	1
100% Rated (3VA6)	2

# 3VA Molded Case Circuit Breakers

## 3VA51 125A Thermal-magnetic Trip Circuit Breakers

Selection

### 3VA51 125A Frame, 1-Pole Thermal-Magnetic Trip Unit

Cont. Ampere Rating	S-Interrupting Class (SEAS)	M-Interrupting Class (MEAS)	H-Interrupting Class (HEAS)
	Catalog Number	Catalog Number	Catalog Number
<b>TM210 FTFM</b>			
15	3VA5195-4ED11-0AA0	3VA5195-5ED11-0AA0	3VA5195-6ED11-0AA0
20	3VA5120-4ED11-0AA0	3VA5120-5ED11-0AA0	3VA5120-6ED11-0AA0
25	3VA5125-4ED11-0AA0	3VA5125-5ED11-0AA0	3VA5125-6ED11-0AA0
30	3VA5130-4ED11-0AA0	3VA5130-5ED11-0AA0	3VA5130-6ED11-0AA0
35	3VA5135-4ED11-0AA0	3VA5135-5ED11-0AA0	3VA5135-6ED11-0AA0
40	3VA5140-4ED11-0AA0	3VA5140-5ED11-0AA0	3VA5140-6ED11-0AA0
45	3VA5145-4ED11-0AA0	3VA5145-5ED11-0AA0	3VA5145-6ED11-0AA0
50	3VA5150-4ED11-0AA0	3VA5150-5ED11-0AA0	3VA5150-6ED11-0AA0
60	3VA5160-4ED11-0AA0	3VA5160-5ED11-0AA0	3VA5160-6ED11-0AA0
70	3VA5170-4ED11-0AA0	3VA5170-5ED11-0AA0	3VA5170-6ED11-0AA0
80	3VA5180-4ED11-0AA0	3VA5180-5ED11-0AA0	3VA5180-6ED11-0AA0
90	3VA5190-4ED11-0AA0	3VA5190-5ED11-0AA0	3VA5190-6ED11-0AA0
100	3VA5110-4ED11-0AA0	3VA5110-5ED11-0AA0	3VA5110-6ED11-0AA0
110	3VA5111-4ED11-0AA0	3VA5111-5ED11-0AA0	3VA5111-6ED11-0AA0
125	3VA5112-4ED11-0AA0	3VA5112-5ED11-0AA0	3VA5112-6ED11-0AA0



3VA51 125A 1-Pole

### 3VA51 125A Frame, 3-Pole Thermal-Magnetic Trip Unit

Cont. Ampere Rating	S-Interrupting Class	M-Interrupting Class	H-Interrupting Class
	Catalog Number	Catalog Number	Catalog Number
<b>TM210 FTFM</b>			
15	3VA5195-4ED31-0AA0	3VA5195-5ED31-0AA0	3VA5195-6ED31-0AA0
20	3VA5120-4ED31-0AA0	3VA5120-5ED31-0AA0	3VA5120-6ED31-0AA0
25	3VA5125-4ED31-0AA0	3VA5125-5ED31-0AA0	3VA5125-6ED31-0AA0
30	3VA5130-4ED31-0AA0	3VA5130-5ED31-0AA0	3VA5130-6ED31-0AA0
35	3VA5135-4ED31-0AA0	3VA5135-5ED31-0AA0	3VA5135-6ED31-0AA0
40	3VA5140-4ED31-0AA0	3VA5140-5ED31-0AA0	3VA5140-6ED31-0AA0
45	3VA5145-4ED31-0AA0	3VA5145-5ED31-0AA0	3VA5145-6ED31-0AA0
50	3VA5150-4ED31-0AA0	3VA5150-5ED31-0AA0	3VA5150-6ED31-0AA0
60	3VA5160-4ED31-0AA0	3VA5160-5ED31-0AA0	3VA5160-6ED31-0AA0
70	3VA5170-4ED31-0AA0	3VA5170-5ED31-0AA0	3VA5170-6ED31-0AA0
80	3VA5180-4ED31-0AA0	3VA5180-5ED31-0AA0	3VA5180-6ED31-0AA0
90	3VA5190-4ED31-0AA0	3VA5190-5ED31-0AA0	3VA5190-6ED31-0AA0
100	3VA5110-4ED31-0AA0	3VA5110-5ED31-0AA0	3VA5110-6ED31-0AA0
110	3VA5111-4ED31-0AA0	3VA5111-5ED31-0AA0	3VA5111-6ED31-0AA0
125	3VA5112-4ED31-0AA0	3VA5112-5ED31-0AA0	3VA5112-6ED31-0AA0



3VA51 125A 3-Pole

### Ordering Information

The catalog numbers listed here are for complete, non-interchangeable trip circuit breakers without lugs.

Order required lugs or connection technology separately for field installation.

All 3VA51 thermal-magnetic trip circuit breakers are UL listed for reverse feed applications.

For NAVAL-rated thermal-magnetic trip circuit breakers, change the 13th digit of the catalog number to the number "1". (For example, a 35KA @480VAC, 40A, 3-pole, NAVAL rated 3VA51 would be catalog number 3VA5140-5ED31-1AA0)

### Enclosures (3-pole only)

Nema Type	Catalog Number
1 surface	3VAE125N1S
1 flush	3VAE125N1F
3R	3VAE125N3R
12	3VAE125N12
4X (304)	3VAE125N4X
4X (316)	3VAE125N4X316
Neutral	N250X
200% Neutral	N2250X

### Dimensions

Breaker	Poles	W in. (mm)	H in. (mm)	D in. (mm)	lbs.	kg
3VA51	1	1 (25.4)	5.5 (140)	3 (76.5)	0.84	0.38
3VA51	3	3 (76.2)	5.5 (140)	3 (76.5)	2.12	0.96

### Shipping Weight

# 3VA Molded Case Circuit Breakers

## 3VA51 125A Thermal-magnetic Trip Circuit Breakers

Technical information

### Interrupting Ratings for 3VA51

Interrupting Class	Breaker Type	RMS Symmetrical Amperes (kA)					
		Volts AC (50/60 Hz)				Volts DC	
		240	480Y/277V	480	600Y/347V	250	500
S	SEAS	65	25	25 <sup>③</sup>	14	50	50
M	MEAS	85	35	35 <sup>③</sup>	18 <sup>④</sup>	85 <sup>①</sup>	85 <sup>①</sup>
H	HEAS	100	65	65 <sup>③</sup>	25 <sup>②</sup>	100 <sup>①</sup>	100 <sup>①</sup>

- ① Applies to 3VA51 3-Pole
- ② In 40A to 90A 18kA; 100A to 125A 14 kA
- ③ Applies to In 15A to 90A
- ④ In 100A to 125A 14kA

### Trip Settings for 3VA51

TM210 - FTFM		
In (A)	I <sub>r</sub> (A)	I <sub>i</sub> (A)
15	15	300
20	20	300
25	25	300
30	30	300
35	35	350
40	40	400
45	45	450
50	50	500
60	60	600
70	70	700
80	80	800
90	90	900
100	100	1000
110	110	1100
125	125	1250

TM230 - FTAM							
In (A)	I <sub>r</sub> (A)	I <sub>i</sub> (A)					
15	15	150	180	210	240	270	300
20	20	150	180	210	240	270	300
25	25	150	180	210	240	270	300
30	30	150	180	210	240	270	300
35	35	175	210	245	280	315	350
40	40	200	240	280	320	360	400
45	45	225	270	315	360	405	450
50	50	250	300	350	400	450	500
60	60	300	360	420	480	540	600
70	70	350	420	490	560	630	700
80	80	400	480	560	640	720	800
90	90	450	540	630	720	810	900
100	100	500	600	700	800	900	1000
110	110	550	660	770	880	990	1100
125	125	625	750	875	1000	1125	1250

### Connectors for 75C Wire for 3VA51

Type	Minimum cable size	Maximum cable size	Catalog Number (kit of 3 lugs)
Steel wrap around (Cu cable only), single cable lugs	AWG 14	3/0	3VA9133-0JA11
Aluminum body lug (Cu/Al cable), single cable lugs	AWG 14	3/0	3VA9133-0JB11
Aluminum body lug with control wire tap (Cu/Al cable), single cable lugs	AWG 14	3/0	3VA9133-0JG11
Aluminum body lug large (Cu/Al cable) single cable lugs with 1 extended terminal cover	AWG 4	300 kcmil	3VA9133-0JJ12
Aluminum body lug large with control wire tap (Cu/Al cable) single cable lugs and 1 extended terminal cover	AWG 4	300 kcmil	3VA9133-0JC12
Distribution lug, 6 Cables (Cu/Al cable) single cable lugs with 1 extended terminal cover	AWG 14	AWG 2	3VA9133-0JF60
Copper body lug (Cu cable only) single cable lugs	AWG 14	2/0	3VA9133-0JD11
Copper body lug with control wire tap (Cu cable only) single cable lugs	AWG 14	2/0	3VA9133-0JK11

Internal accessories Optional equipment	Type	3VA5 125 A 3-pole		3VA5 250 A 2(3)-pole & 3-pole	
		Slot No.: 23 22 21 11 12 13	Slot No.: 24 23 22 21 11 12 13 14		
Auxiliary switch	AUX_HQ	x x x	x x x	x x x x	x x x x
Auxiliary switch	AUX_HQ_el	x x x	x x x	x x x x	x x x x
Auxiliary switch	AUX_HP	x	x	x x	x x
Leading changeover switch	LCS_HQ		x		x
Leading changeover switch	LCS_HQ_el		x		x
Leading changeover switch	LCS_HP		x		x
Alarm switch	TAS_HQ	x x	x x	x x	x x
Trip alarm switch	TAS_HQ_el	x x	x x	x x	x x
Trip alarm switch	TAS_HP	x	x	x	x
Auxiliary release	STF	x		x	
Auxiliary release	STL	x		x	
Auxiliary release	UVR	x		x	
Auxiliary release	UNI	x		x	
Other	Cylinder lock (type Ronis)		x		x

7 MOLDED CASE CIRCUIT BREAKERS

# 3VA Molded Case Circuit Breakers

## 3VA61 150A Electronic Trip Circuit Breakers

Selection



3VA61 150A 3-Pole

### Ordering Information

The catalog numbers listed below are for complete, non-interchangeable trip circuit breakers without lugs.

Order required lugs or connection technology separately for field installation.

All 3VA61 electronic trip circuit breakers are UL listed for reverse feed applications.

All 3VA61 electronic trip circuit breakers are available with 100% ratings.

For 100% rated electronic trip circuit breakers, change the 13th digit of the catalog number to the number "2". (For example, a 35KA @480VAC, 40A, 3-pole, 100% rated 3VA61 would be catalog number 3VA6140-5HL31-2AA0) Requires the use of copper lugs — see lug table below.

All 3VA6 circuit breakers are certified to UL 489 Supplement SB, are marked "Naval", and are suitable for use at 50C.

## 3VA61 150A Frame 3-Pole Electronic Trip Unit

Continuous Ampere	M-Interrupting Class (MDAE)	H-Interrupting Class (HDAE)	C-Interrupting Class (CDAE)	L-Interrupting Class (LDAE)
	Catalog Number	Catalog Number	Catalog Number	Catalog Number
<b>ETU320 LI with dials</b>				
40	3VA6140-5HL31-0AA0	3VA6140-6HL31-0AA0	3VA6140-7HL31-0AA0	3VA6140-8HL31-0AA0
100	3VA6110-5HL31-0AA0	3VA6110-6HL31-0AA0	3VA6110-7HL31-0AA0	3VA6110-8HL31-0AA0
150	3VA6115-5HL31-0AA0	3VA6115-6HL31-0AA0	3VA6115-7HL31-0AA0	3VA6115-8HL31-0AA0
<b>ETU330 LIG with dials</b>				
40	3VA6140-5HM31-0AA0	3VA6140-6HM31-0AA0	3VA6140-7HM31-0AA0	3VA6140-8HM31-0AA0
100	3VA6110-5HM31-0AA0	3VA6110-6HM31-0AA0	3VA6110-7HM31-0AA0	3VA6110-8HM31-0AA0
150	3VA6115-5HM31-0AA0	3VA6115-6HM31-0AA0	3VA6115-7HM31-0AA0	3VA6115-8HM31-0AA0
<b>ETU350 LSI with dials</b>				
40	3VA6140-5HN31-0AA0	3VA6140-6HN31-0AA0	3VA6140-7HN31-0AA0	3VA6140-8HN31-0AA0
100	3VA6110-5HN31-0AA0	3VA6110-6HN31-0AA0	3VA6110-7HN31-0AA0	3VA6110-8HN31-0AA0
150	3VA6115-5HN31-0AA0	3VA6115-6HN31-0AA0	3VA6115-7HN31-0AA0	3VA6115-8HN31-0AA0
<b>ETU550 LSI with LCD</b>				
40	3VA6140-5JP31-0AA0	3VA6140-6JP31-0AA0	3VA6140-7JP31-0AA0	3VA6140-8JP31-0AA0
100	3VA6110-5JP31-0AA0	3VA6110-6JP31-0AA0	3VA6110-7JP31-0AA0	3VA6110-8JP31-0AA0
150	3VA6115-5JP31-0AA0	3VA6115-6JP31-0AA0	3VA6115-7JP31-0AA0	3VA6115-8JP31-0AA0
<b>ETU556 LSI(G Alarm) with LCD</b>				
40	3VA6140-5JT31-0AA0	3VA6140-6JT31-0AA0	3VA6140-7JT31-0AA0	3VA6140-8JT31-0AA0
100	3VA6110-5JT31-0AA0	3VA6110-6JT31-0AA0	3VA6110-7JT31-0AA0	3VA6110-8JT31-0AA0
150	3VA6115-5JT31-0AA0	3VA6115-6JT31-0AA0	3VA6115-7JT31-0AA0	3VA6115-8JT31-0AA0
<b>ETU560 LSI(G) with LCD</b>				
40	3VA6140-5JQ31-0AA0	3VA6140-6JQ31-0AA0	3VA6140-7JQ31-0AA0	3VA6140-8JQ31-0AA0
100	3VA6110-5JQ31-0AA0	3VA6110-6JQ31-0AA0	3VA6110-7JQ31-0AA0	3VA6110-8JQ31-0AA0
150	3VA6115-5JQ31-0AA0	3VA6115-6JQ31-0AA0	3VA6115-7JQ31-0AA0	3VA6115-8JQ31-0AA0
<b>ETU820 LI LCD with Metering</b>				
40	3VA6140-5KL31-0AA0	3VA6140-6KL31-0AA0	3VA6140-7KL31-0AA0	3VA6140-8KL31-0AA0
100	3VA6110-5KL31-0AA0	3VA6110-6KL31-0AA0	3VA6110-7KL31-0AA0	3VA6110-8KL31-0AA0
150	3VA6115-5KL31-0AA0	3VA6115-6KL31-0AA0	3VA6115-7KL31-0AA0	3VA6115-8KL31-0AA0
<b>ETU830 LIG with LCD and Metering</b>				
40	3VA6140-5KM31-0AA0	3VA6140-6KM31-0AA0	3VA6140-7KM31-0AA0	3VA6140-8KM31-0AA0
100	3VA6110-5KM31-0AA0	3VA6110-6KM31-0AA0	3VA6110-7KM31-0AA0	3VA6110-8KM31-0AA0
150	3VA6115-5KM31-0AA0	3VA6115-6KM31-0AA0	3VA6115-7KM31-0AA0	3VA6115-8KM31-0AA0
<b>ETU850 LSI with LCD and Metering</b>				
40	3VA6140-5KP31-0AA0	3VA6140-6KP31-0AA0	3VA6140-7KP31-0AA0	3VA6140-8KP31-0AA0
100	3VA6110-5KP31-0AA0	3VA6110-6KP31-0AA0	3VA6110-7KP31-0AA0	3VA6110-8KP31-0AA0
150	3VA6115-5KP31-0AA0	3VA6115-6KP31-0AA0	3VA6115-7KP31-0AA0	3VA6115-8KP31-0AA0
<b>ETU856 LSI(G Alarm) with LCD and Metering</b>				
40	3VA6140-5KT31-0AA0	3VA6140-6KT31-0AA0	3VA6140-7KT31-0AA0	3VA6140-8KT31-0AA0
100	3VA6110-5KT31-0AA0	3VA6110-6KT31-0AA0	3VA6110-7KT31-0AA0	3VA6110-8KT31-0AA0
150	3VA6115-5KT31-0AA0	3VA6115-6KT31-0AA0	3VA6115-7KT31-0AA0	3VA6115-8KT31-0AA0
<b>ETU860 LSI(G) with LCD and Metering</b>				
40	3VA6140-5KQ31-0AA0	3VA6140-6KQ31-0AA0	3VA6140-7KQ31-0AA0	3VA6140-8KQ31-0AA0
100	3VA6110-5KQ31-0AA0	3VA6110-6KQ31-0AA0	3VA6110-7KQ31-0AA0	3VA6110-8KQ31-0AA0
150	3VA6115-5KQ31-0AA0	3VA6115-6KQ31-0AA0	3VA6115-7KQ31-0AA0	3VA6115-8KQ31-0AA0

# 3VA Molded Case Circuit Breakers

## 3VA61 150A Electronic Trip Circuit Breakers

Selection



3VA61 150A 4-Pole

### Ordering Information

The catalog numbers listed below are for complete, non-interchangeable trip circuit breakers without lugs.

Order required lugs or connection technology separately for field installation.

All 3VA61 electronic trip circuit breakers are UL listed for reverse feed applications.

All 3VA61 electronic trip circuit breakers are available with 100% ratings.

For 100% rated electronic trip circuit breakers, change the 13th digit of the catalog number to the number "2". (For example, a 35KA @480VAC, 40A, 3-pole, 100% rated 3VA61 would be catalog number 3VA6140-5HL31-2AA0) Requires the use of copper lugs — see lug table below.

All 3VA6 circuit breakers are certified to UL 489 Supplement SB, are marked "Naval", and are suitable for use at 50C.

## 3VA61 150A Frame 4-Pole Electronic Trip Unit

Continuous Ampere	M-Interrupting Class (MDAE)	H-Interrupting Class (HDAE)	C-Interrupting Class (CDAE)	L-Interrupting Class (LDAE)
	Catalog Number	Catalog Number	Catalog Number	Catalog Number
<b>ETU320 LI with dials</b>				
40	3VA6140-5HL41-0AA0	3VA6140-6HL41-0AA0	3VA6140-7HL41-0AA0	3VA6140-8HL41-0AA0
100	3VA6110-5HL41-0AA0	3VA6110-6HL41-0AA0	3VA6110-7HL41-0AA0	3VA6110-8HL41-0AA0
150	3VA6115-5HL41-0AA0	3VA6115-6HL41-0AA0	3VA6115-7HL41-0AA0	3VA6115-8HL41-0AA0
<b>ETU330 LIG with dials</b>				
40	3VA6140-5HM41-0AA0	3VA6140-6HM41-0AA0	3VA6140-7HM41-0AA0	3VA6140-8HM41-0AA0
100	3VA6110-5HM41-0AA0	3VA6110-6HM41-0AA0	3VA6110-7HM41-0AA0	3VA6110-8HM41-0AA0
150	3VA6115-5HM41-0AA0	3VA6115-6HM41-0AA0	3VA6115-7HM41-0AA0	3VA6115-8HM41-0AA0
<b>ETU350 LSI with dials</b>				
40	3VA6140-5HN41-0AA0	3VA6140-6HN41-0AA0	3VA6140-7HN41-0AA0	3VA6140-8HN41-0AA0
100	3VA6110-5HN41-0AA0	3VA6110-6HN41-0AA0	3VA6110-7HN41-0AA0	3VA6110-8HN41-0AA0
150	3VA6115-5HN41-0AA0	3VA6115-6HN41-0AA0	3VA6115-7HN41-0AA0	3VA6115-8HN41-0AA0
<b>ETU550 LSI with LCD</b>				
40	3VA6140-5JP41-0AA0	3VA6140-6JP41-0AA0	3VA6140-7JP41-0AA0	3VA6140-8JP41-0AA0
100	3VA6110-5JP41-0AA0	3VA6110-6JP41-0AA0	3VA6110-7JP41-0AA0	3VA6110-8JP41-0AA0
150	3VA6115-5JP41-0AA0	3VA6115-6JP41-0AA0	3VA6115-7JP41-0AA0	3VA6115-8JP41-0AA0
<b>ETU556 LSI(G Alarm) with LCD</b>				
40	3VA6140-5JT41-0AA0	3VA6140-6JT41-0AA0	3VA6140-7JT41-0AA0	3VA6140-8JT41-0AA0
100	3VA6110-5JT41-0AA0	3VA6110-6JT41-0AA0	3VA6110-7JT41-0AA0	3VA6110-8JT41-0AA0
150	3VA6115-5JT41-0AA0	3VA6115-6JT41-0AA0	3VA6115-7JT41-0AA0	3VA6115-8JT41-0AA0
<b>ETU560 LSI(G) with LCD</b>				
40	3VA6140-5JQ41-0AA0	3VA6140-6JQ41-0AA0	3VA6140-7JQ41-0AA0	3VA6140-8JQ41-0AA0
100	3VA6110-5JQ41-0AA0	3VA6110-6JQ41-0AA0	3VA6110-7JQ41-0AA0	3VA6110-8JQ41-0AA0
150	3VA6115-5JQ41-0AA0	3VA6115-6JQ41-0AA0	3VA6115-7JQ41-0AA0	3VA6115-8JQ41-0AA0
<b>ETU820 LI LCD with Metering</b>				
40	3VA6140-5KL41-0AA0	3VA6140-6KL41-0AA0	3VA6140-7KL41-0AA0	3VA6140-8KL41-0AA0
100	3VA6110-5KL41-0AA0	3VA6110-6KL41-0AA0	3VA6110-7KL41-0AA0	3VA6110-8KL41-0AA0
150	3VA6115-5KL41-0AA0	3VA6115-6KL41-0AA0	3VA6115-7KL41-0AA0	3VA6115-8KL41-0AA0
<b>ETU830 LIG with LCD and Metering</b>				
40	3VA6140-5KM41-0AA0	3VA6140-6KM41-0AA0	3VA6140-7KM41-0AA0	3VA6140-8KM41-0AA0
100	3VA6110-5KM41-0AA0	3VA6110-6KM41-0AA0	3VA6110-7KM41-0AA0	3VA6110-8KM41-0AA0
150	3VA6115-5KM41-0AA0	3VA6115-6KM41-0AA0	3VA6115-7KM41-0AA0	3VA6115-8KM41-0AA0
<b>ETU850 LSI with LCD and Metering</b>				
40	3VA6140-5KP41-0AA0	3VA6140-6KP41-0AA0	3VA6140-7KP41-0AA0	3VA6140-8KP41-0AA0
100	3VA6110-5KP41-0AA0	3VA6110-6KP41-0AA0	3VA6110-7KP41-0AA0	3VA6110-8KP41-0AA0
150	3VA6115-5KP41-0AA0	3VA6115-6KP41-0AA0	3VA6115-7KP41-0AA0	3VA6115-8KP41-0AA0
<b>ETU856 LSI(G Alarm) with LCD and Metering</b>				
40	3VA6140-5KT41-0AA0	3VA6140-6KT41-0AA0	3VA6140-7KT41-0AA0	3VA6140-8KT41-0AA0
100	3VA6110-5KT41-0AA0	3VA6110-6KT41-0AA0	3VA6110-7KT41-0AA0	3VA6110-8KT41-0AA0
150	3VA6115-5KT41-0AA0	3VA6115-6KT41-0AA0	3VA6115-7KT41-0AA0	3VA6115-8KT41-0AA0
<b>ETU860 LSI(G) with LCD and Metering</b>				
40	3VA6140-5KQ41-0AA0	3VA6140-6KQ41-0AA0	3VA6140-7KQ41-0AA0	3VA6140-8KQ41-0AA0
100	3VA6110-5KQ41-0AA0	3VA6110-6KQ41-0AA0	3VA6110-7KQ41-0AA0	3VA6110-8KQ41-0AA0
150	3VA6115-5KQ41-0AA0	3VA6115-6KQ41-0AA0	3VA6115-7KQ41-0AA0	3VA6115-8KQ41-0AA0

# 3VA Molded Case Circuit Breakers

## 3VA61 150A Electronic Trip Circuit Breakers

Technical information

### Connectors for 75C wire for 3VA61

Type	Minimum cable size	Maximum cable size	Part Number (kit of 3 lugs)	Part Number (kit of 4 lugs)
Steel Wrap around (Cu cable only) single cable lugs	AWG 10	3/0	3VA9143-0JA12	3VA9144-0JA12
	AWG 4	350 kcmil	3VA9243-0JA12	3VA9244-0JA12
Aluminum Body Lug (Cu/Al cable) single cable lugs	AWG 14	1/0	3VA9143-0JB11	3VA9144-0JB11
	AWG 6	350 kcmil	3VA9243-0JB12	3VA9244-0JB12
Aluminum body lug with control wire tap (Cu/Al cable) single cable lugs	AWG 14	1/0	3VA9143-0JG11	3VA9144-0JG11
	AWG 6	350 kcmil	3VA9243-0JG12	3VA9244-0JG12
Aluminum body lug large (Cu/Al cable) single cable lugs and 1 ext'd terminal cover	AWG 2	350 kcmil	3VA9243-0JJ13	3VA9244-0JJ13
Aluminum body lug large with control wire tap (Cu/Al cable) single cable lugs and 1 extended terminal cover	AWG 2	350 kcmil	3VA9243-0JC13	3VA9244-0JC13
Aluminum body lug, 2 cables (Cu/Al cable) with 1 extended terminal cover	AWG 4	300 kcmil	3VA9243-0JJ22	3VA9244-0JJ22
Aluminum body lug, 2 cables (Cu/Al cable) with control wire tap and 1 extended terminal cover	AWG 4	300 kcmil	3VA9243-0JC22	3VA9244-0JC22
Distribution lug, 6 Cables (Cu/Al cable) with 1 extended terminal cover	AWG 14	AWG 2	3VA9243-0JF60	3VA9244-0JF60
Copper body lug (Cu cable only) single cable lugs kit of 3 single lugs (meets requirements for 100% rated breakers)	AWG 14	1/0	3VA9143-0JD11	3VA9144-0JD11
	AWG 6	350 kcmil	3VA9243-0JD12	3VA9244-0JD12
Copper body lug (Cu cable only) with control wire tap single cable lugs	AWG 14	1/0	3VA9143-0JK11	3VA9144-0JK11
	AWG 6	350 kcmil	3VA9243-0JK12	3VA9244-0JK12

### Interrupting Ratings for 3VA61

Interrupting Class	Breaker Type	RMS Symmetrical Amperes (kA)					
		Volts AC (50/60 Hz)				Volts DC	
		240	480Y/277V	480	600Y/347V	250	500
M	MDAE	100	35	35	18	18	25
H	HDAE	100	65	65	22	22	35
C	CDAE	200	100	100	35	35	65
L	LDAE	200	150	150	50	50	65

### Enclosures (3-pole only)

Nema Type	Catalog Number
1 surface	3VAE250N1S
1 flush	3VAE250N1F
3R	3VAE250N3R
12	3VAE250N12
4X (304)	3VAE250N4X
4X (316)	3VAE250N4X316
Neutral	N250X
200% Neutral	N2250X

### Dimensions

Breaker	Poles	W in. (mm)	H in. (mm)	D in. (mm)	lbs.	kg
3VA61	3	4.1 (105)	7.8 (198)	3.4 (86)	5.5	2.5
3VA61	4	5.5 (140)	7.8 (198)	3.4 (86)	7.1	3.2

### Shipping Weight



# 3VA Molded Case Circuit Breakers

## 3VA61 150A Electronic Trip Circuit Breakers

Technical information

### Trip Settings for 3VA61

ETU320-LI, ETU330-LIG, ETU350-LSI

Continuous Amperage	LI, LIG, LSI			LSI		LIG	LI, LIG, LSI 4P only
$I_n$ (Amp)	$I_r$ (Amp) (L)	$t_{td}$ (sec) (L)	$I_i$ (Amp) (I)①	$I_{sd} = xI_r$ (Amp) (S)	$t_{sd}$ (sec) (S)	$I_g$ (Amp) (G)	$I_N = xI_r$ (Amp)
40	15 - 40	0.5 - 17	60-480	1.5 - 10	0.08 - 0.4	15 - 40	1 / OFF
100	40 - 100	0.5 - 17	150-1200	1.5 - 10		20 - 100	0.5 - 1 / OFF
150	60 - 150	0.5 - 17	225-1500	1.5 - 10		30 - 150	0.5 - 1 / OFF

①  $I_i$  for ETU350 is fixed at 12X  $I_n$

ETU550-LSI, ETU556 LSI(A), ETU560-LSIG, ETU820-LI, ETU830-LIG, ETU850-LSI, ETU856 LSI(A), ETU860-LSIG

Continuous Amperage	LI, LIG, LSI, LSIG, LSI(G)			LSI, LSIG, LSI(G)		LIG, LSIG, LSI(G)		LSI 3P with External CT	LI, LIG, LSI, LSIG, LSI(G) 4P only
$I_n$ (Amp)	$I_r$ (Amp) (L)	$t_{td}$ (sec) (L)	$I_i$ (Amp) (I)	$I_{sd}$ (Amp) (S)	$t_{sd}$ (sec) (S)	$I_g$ (Amp) (G)	$t_g$ (G)	$I_N = xI_r$ (Amp)	$I_N$ (Amp)
40	15 - 40	0.5 - 25	60-480	24 - 400	0.05 - 0.5	15 - 40	0.05 - 0.8	15 - 64 / OFF	15 - 64 / OFF
100	40 - 100	0.5 - 25	150-1200	60 - 1000		20 - 100		20 - 160 / OFF	20 - 150 / OFF
150	60 - 150	0.5 - 20	225-1500	90 - 1500		30 - 150		30 - 240 / OFF	30 - 150 / OFF

Internal accessories Optional equipment	Slot No.:	3VA6 150/250 A 3-pole											3VA6 150/250 A 4-pole										
		24	23	22	21	11	12	13	14	34	33	32	31	24	23	22	21	11	12	13	14		
Auxiliary switch	Type																						
	AUX_HQ	x	x	x	x	x	x	x	x	x	x	x	x	x	x	x	x	x	x	x	x	x	
Auxiliary switch	AUX_HQ_el	x	x	x	x	x	x	x	x	x	x	x	x	x	x	x	x	x	x	x	x	x	
	AUX_HP	x	x			x	x	x		x	x	x	x	x	x	x		x	x		x	x	
	LCS_HQ							x													x		
Leading changeover switch	LCS_HQ_el							x													x		
	LCS_HP							x													x		
Alarm switch	Type																						
	TAS_HQ		x	x		x	x											x	x		x	x	
Trip alarm switch	TAS_HQ_el		x	x		x	x											x	x		x	x	
	TAS_HP		x			x												x			x		
Electrical alarm switch	EAS_HQ																				x		
	EAS_HQ_el																				x		
Auxiliary release	Type																						
	STF		x					x										x			x		
Shunt trip left	STL		x															x					
Undervoltage release	UVR		x															x					
Universal release	UNI		x															x					
ETU/communication	Type																						
	COM060																					x	
Communication module Breaker data server																						x	
24 V module																						x	
Other																							
	Cylinder lock (type Ronis)																					x	

1201\_19495

See page 7-65 for internal accessory part numbers.

# 3VA Molded Case Circuit Breakers

## 3VA52 250A Thermal-magnetic Trip Circuit Breakers

Selection

### 3VA52 250 A Frame, 2-(3)Pole Thermal-Magnetic Trip Unit

Cont. Ampere Rating	M-Interrupting Class (MFAS)	H-Interrupting Class (HFAS)	C-Interrupting Class (CFAS)
	Catalog Number	Catalog Number	Catalog Number
<b>TM210 FTFM</b>			
100	3VA5210-5ED61-0AA0	3VA5210-6ED61-0AA0	3VA5210-7ED61-0AA0
110	3VA5211-5ED61-0AA0	3VA5211-6ED61-0AA0	3VA5211-7ED61-0AA0
125	3VA5212-5ED61-0AA0	3VA5212-6ED61-0AA0	3VA5212-7ED61-0AA0
150	3VA5215-5ED61-0AA0	3VA5215-6ED61-0AA0	3VA5215-7ED61-0AA0
175	3VA5217-5ED61-0AA0	3VA5217-6ED61-0AA0	3VA5217-7ED61-0AA0
200	3VA5220-5ED61-0AA0	3VA5220-6ED61-0AA0	3VA5220-7ED61-0AA0
225	3VA5222-5ED61-0AA0	3VA5222-6ED61-0AA0	3VA5222-7ED61-0AA0
250	3VA5225-5ED61-0AA0	3VA5225-6ED61-0AA0	3VA5225-7ED61-0AA0
<b>TM230 FTAM</b>			
100	3VA5210-5EC61-0AA0	3VA5210-6EC61-0AA0	3VA5210-7EC61-0AA0
110	3VA5211-5EC61-0AA0	3VA5211-6EC61-0AA0	3VA5211-7EC61-0AA0
125	3VA5212-5EC61-0AA0	3VA5212-6EC61-0AA0	3VA5212-7EC61-0AA0
150	3VA5215-5EC61-0AA0	3VA5215-6EC61-0AA0	3VA5215-7EC61-0AA0
175	3VA5217-5EC61-0AA0	3VA5217-6EC61-0AA0	3VA5217-7EC61-0AA0
200	3VA5220-5EC61-0AA0	3VA5220-6EC61-0AA0	3VA5220-7EC61-0AA0
225	3VA5222-5EC61-0AA0	3VA5222-6EC61-0AA0	3VA5222-7EC61-0AA0
250	3VA5225-5EC61-0AA0	3VA5225-6EC61-0AA0	3VA5225-7EC61-0AA0



3VA52 250A 3-Pole

#### Ordering Information

The catalog numbers listed here are for complete, non-interchangeable trip circuit breakers without lugs.

Order required lugs or connection technology separately for field installation.

All 3VA52 thermal-magnetic trip circuit breakers are UL listed for reverse feed applications.

For NAVAL rated thermal-magnetic trip circuit breakers, change the 13th digit of the catalog number to the number "1". (For example, a 35KA @480VAC, 150A, 3-pole, NAVAL rated 3VA52 would be catalog number 3VA5215-5ED31-**1**AA0)

### 3VA52 250 A Frame, 3-Pole Thermal-Magnetic Trip Unit

Cont. Ampere Rating	M-Interrupting Class (MFAS)	H-Interrupting Class (HFAS)	C-Interrupting Class (CFAS)
	Catalog Number	Catalog Number	Catalog Number
<b>TM210 FTFM</b>			
100	3VA5210-5ED31-0AA0	3VA5210-6ED31-0AA0	3VA5210-7ED31-0AA0
110	3VA5211-5ED31-0AA0	3VA5211-6ED31-0AA0	3VA5211-7ED31-0AA0
125	3VA5212-5ED31-0AA0	3VA5212-6ED31-0AA0	3VA5212-7ED31-0AA0
150	3VA5215-5ED31-0AA0	3VA5215-6ED31-0AA0	3VA5215-7ED31-0AA0
175	3VA5217-5ED31-0AA0	3VA5217-6ED31-0AA0	3VA5217-7ED31-0AA0
200	3VA5220-5ED31-0AA0	3VA5220-6ED31-0AA0	3VA5220-7ED31-0AA0
225	3VA5222-5ED31-0AA0	3VA5222-6ED31-0AA0	3VA5222-7ED31-0AA0
250	3VA5225-5ED31-0AA0	3VA5225-6ED31-0AA0	3VA5225-7ED31-0AA0
<b>TM230 FTAM</b>			
100	3VA5210-5EC31-0AA0	3VA5210-6EC31-0AA0	3VA5210-7EC31-0AA0
110	3VA5211-5EC31-0AA0	3VA5211-6EC31-0AA0	3VA5211-7EC31-0AA0
125	3VA5212-5EC31-0AA0	3VA5212-6EC31-0AA0	3VA5212-7EC31-0AA0
150	3VA5215-5EC31-0AA0	3VA5215-6EC31-0AA0	3VA5215-7EC31-0AA0
175	3VA5217-5EC31-0AA0	3VA5217-6EC31-0AA0	3VA5217-7EC31-0AA0
200	3VA5220-5EC31-0AA0	3VA5220-6EC31-0AA0	3VA5220-7EC31-0AA0
225	3VA5222-5EC31-0AA0	3VA5222-6EC31-0AA0	3VA5222-7EC31-0AA0
250	3VA5225-5EC31-0AA0	3VA5225-6EC31-0AA0	3VA5225-7EC31-0AA0

#### Enclosures (3-pole only)

Nema Type	Catalog Number
1 surface	3VAE250N1S
1 flush	3VAE250N1F
3R	3VAE250N3R
12	3VAE250N12
4X (304)	3VAE250N4X
4X (316)	3VAE250N4X316
Neutral	N250X
200% Neutral	N2250X

#### Dimensions

Breaker	Poles	W in. (mm)	H in. (mm)	D in. (mm)	lbs.	kg
3VA52	2(3-) pole	4.1 (105)	7.3 (185)	3.3 (83)	4.1	1.9
3VA52	3-pole	4.1 (105)	7.3 (185)	3.3 (83)	4.5	2.1

#### Shipping Weight

# 3VA Molded Case Circuit Breakers

## 3VA52 250A Thermal-magnetic Trip Circuit Breakers

Technical information

### Interrupting Ratings for 3VA52

Interrupting Class	Breaker Type	RMS Symmetrical Amperes (kA)							
		Volts AC (50/60 Hz)					Volts DC		
		240	480Y/277V	480	600Y/347V	600	250	500	600 (3P)
M	MFAS	85	35	35	18	50	50	50	50
H	HFAS	100	65	65	25	85	85	85	85
C	CFAS	200	100	100	35	100	100	100	100

### Trip Settings for 3VA52

TM210 - FTFM		
I <sub>n</sub> (A)	I <sub>r</sub> (A)	I <sub>i</sub> (A)
100	100	1000
110	110	1100
125	125	1250
150	150	1500
175	175	1750
200	200	2000
225	225	2250
250	250	2500

TM230 - FTAM							
I <sub>n</sub> (A)	I <sub>r</sub> (A)	I <sub>i</sub> (A)					
100	100	500	600	700	800	900	1000
110	110	550	660	770	880	990	1100
125	125	625	750	875	1000	1125	1125
150	150	750	900	1050	1200	1350	1500
175	175	875	1050	1225	1400	1575	1750
200	200	1000	1200	1400	1600	1800	2000
225	225	1125	1350	1575	1800	2025	2250
250	250	1250	1500	1750	2000	2250	2500

### Connectors for 75C Wire for 3VA52

Type	Minimum cable size	Maximum cable size	Part Number (kit of 3 lugs)
Steel wrap around (Cu cable only), single cable lugs	AWG 10	3/0	3VA9233-0JA11
	AWG 4	350 kcmil	3VA9233-0JA12
Aluminum body lug (Cu/Al cable), single cable lugs	AWG 6	350 kcmil	3VA9233-0JB12
Aluminum body lug (Cu/Al cable) with control wire tap, single cable lugs	AWG 6	350 kcmil	3VA9233-0JG12
Aluminum body lug large (Cu/Al cable) single cable lugs with 1 extended terminal cover	AWG 2	350 kcmil	3VA9233-0JJ13
Aluminum body lug large with control wire tap (Cu/Al cable) single cable lugs and 1 extended terminal cover	AWG 2	350 kcmil	3VA9233-0JC13
Aluminum body lug, 2 cables (Cu/Al cable) with control wire tap and 1 extended terminal cover	AWG 4	300 kcmil	3VA9233-0JJ22
Distribution lug, 6 Cables (Cu/Al cable) with 1 extended terminal cover	AWG 14	AWG 2	3VA9233-0JF60
Copper body lug (Cu cable only) single cable lugs	AWG 6	350 kcmil	3VA9233-0JD12
Copper body lug with control wire tap (Cu cable only) single cable lugs	AWG 6	350 kcmil	3VA9233-0JK12

See page 7-65 for internal accessory part numbers.

Internal accessories Optional equipment	Type	3VA5 125 A 3-pole					3VA5 250 A 2(3)-pole & 3-pole								
		23	22	21	11	12	13	24	23	22	21	11	12	13	14
<b>Slot No.:</b>		125 A					250 A								
Auxiliary switch	AUX_HQ	x	x	x	x	x	x	x	x	x	x	x	x	x	x
	AUX_HQ_el	x	x	x	x	x	x	x	x	x	x	x	x	x	x
	AUX_HP	x			x		x	x	x	x	x	x			x
Leading changeover switch	LCS_HQ				x						x				x
	LCS_HQ_el				x					x					x
	LCS_HP				x					x					x
Alarm switch	TAS_HQ	x	x		x	x		x	x		x	x		x	x
	TAS_HQ_el	x	x		x	x		x	x		x	x		x	x
	TAS_HP	x			x		x			x			x		x
Auxiliary release	STF	x					x					x			
	STL	x					x					x			
Undervoltage release	UVR	x					x				x				
	UNI	x					x				x				
<b>Other</b>															
Cylinder lock (type Ronis)							x								x

7 MOLDED CASE CIRCUIT BREAKERS

1201\_19494

# 3VA Molded Case Circuit Breakers

## 3VA62 250A Electronic Trip Circuit Breakers

Selection



3VA62 250A 3-Pole

### Ordering Information

The catalog numbers listed below are for complete, non-interchangeable trip circuit breakers without lugs.

Order required lugs or connection technology separately for field installation.

All 3VA62 electronic trip circuit breakers are UL listed for reverse feed applications.

All 3VA62 electronic trip circuit breakers are available with 100% ratings.

For 100% rated electronic trip circuit breakers, change the 13th digit of the catalog number to the number "2". (For example, a 35KA @480VAC, 100A, 3-pole, 100% rated 3VA62 would be catalog number 3VA6210-5HL31-**2**AA0) Requires the use of copper lugs — see lug table below.

All 3VA6 circuit breakers are certified to UL 489 Supplement SB, are marked "Naval", and are suitable for use at 50C.

## 3VA62 250A Frame 3-Pole Electronic Trip Unit

Continuous Ampere	M-Interrupting Class (MFAE-Y)	H-Interrupting Class (HFAE-Y)	C-Interrupting Class (CFAE-Y)	L-Interrupting Class (LFAE-Y)
	Catalog Number	Catalog Number	Catalog Number	Catalog Number
<b>ETU320 LI with dials</b>				
100	3VA6210-5HL31-0AA0	3VA6210-6HL31-0AA0	3VA6210-7HL31-0AA0	3VA6210-8HL31-0AA0
250	3VA6225-5HL31-0AA0	3VA6225-6HL31-0AA0	3VA6225-7HL31-0AA0	3VA6225-8HL31-0AA0
<b>ETU330 LIG with dials</b>				
100	3VA6210-5HM31-0AA0	3VA6210-6HM31-0AA0	3VA6210-7HM31-0AA0	3VA6210-8HM31-0AA0
250	3VA6225-5HM31-0AA0	3VA6225-6HM31-0AA0	3VA6225-7HM31-0AA0	3VA6225-8HM31-0AA0
<b>ETU350 LSI with dials</b>				
100	3VA6210-5HN31-0AA0	3VA6210-6HN31-0AA0	3VA6210-7HN31-0AA0	3VA6210-8HN31-0AA0
150	3VA6225-5HN31-0AA0	3VA6225-6HN31-0AA0	3VA6225-7HN31-0AA0	3VA6225-8HN31-0AA0
<b>ETU550 LSI with LCD</b>				
100	3VA6210-5JP31-0AA0	3VA6210-6JP31-0AA0	3VA6210-7JP31-0AA0	3VA6210-8JP31-0AA0
250	3VA6225-5JP31-0AA0	3VA6225-6JP31-0AA0	3VA6225-7JP31-0AA0	3VA6225-8JP31-0AA0
<b>ETU556 LSI(G Alarm) with LCD</b>				
100	3VA6210-5JT31-0AA0	3VA6210-6JT31-0AA0	3VA6210-7JT31-0AA0	3VA6210-8JT31-0AA0
250	3VA6225-5JT31-0AA0	3VA6225-6JT31-0AA0	3VA6225-7JT31-0AA0	3VA6225-8JT31-0AA0
<b>ETU560 LSIG with LCD</b>				
100	3VA6210-5JQ31-0AA0	3VA6210-6JQ31-0AA0	3VA6210-7JQ31-0AA0	3VA6210-8JQ31-0AA0
250	3VA6225-5JQ31-0AA0	3VA6225-6JQ31-0AA0	3VA6225-7JQ31-0AA0	3VA6225-8JQ31-0AA0
<b>ETU820 LI with LCD and Metering</b>				
100	3VA6210-5KL31-0AA0	3VA6210-6KL31-0AA0	3VA6210-7KL31-0AA0	3VA6210-8KL31-0AA0
250	3VA6225-5KL31-0AA0	3VA6225-6KL31-0AA0	3VA6225-7KL31-0AA0	3VA6225-8KL31-0AA0
<b>ETU830 LIG with LCD and Metering</b>				
100	3VA6210-5KM31-0AA0	3VA6210-6KM31-0AA0	3VA6210-7KM31-0AA0	3VA6210-8KM31-0AA0
250	3VA6225-5KM31-0AA0	3VA6225-6KM31-0AA0	3VA6225-7KM31-0AA0	3VA6225-8KM31-0AA0
<b>ETU850 LSI with LCD and Metering</b>				
100	3VA6210-5KP31-0AA0	3VA6210-6KP31-0AA0	3VA6210-7KP31-0AA0	3VA6210-8KP31-0AA0
250	3VA6225-5KP31-0AA0	3VA6225-6KP31-0AA0	3VA6225-7KP31-0AA0	3VA6225-8KP31-0AA0
<b>ETU856 LSI(G Alarm) with LCD and Metering</b>				
100	3VA6210-5KT31-0AA0	3VA6210-6KT31-0AA0	3VA6210-7KT31-0AA0	3VA6210-8KT31-0AA0
250	3VA6225-5KT31-0AA0	3VA6225-6KT31-0AA0	3VA6225-7KT31-0AA0	3VA6225-8KT31-0AA0
<b>ETU860 LSIG with LCD and Metering</b>				
100	3VA6210-5KQ31-0AA0	3VA6210-6KQ31-0AA0	3VA6210-7KQ31-0AA0	3VA6210-8KQ31-0AA0
250	3VA6225-5KQ31-0AA0	3VA6225-6KQ31-0AA0	3VA6225-7KQ31-0AA0	3VA6225-8KQ31-0AA0

# 3VA Molded Case Circuit Breakers

## 3VA62 250A Electronic Trip Circuit Breakers

Selection



3VA62 250A 4-Pole

### Ordering Information

The catalog numbers listed below are for complete, non-interchangeable trip circuit breakers without lugs.

Order required lugs or connection technology separately for field installation.

All 3VA62 electronic trip circuit breakers are UL listed for reverse feed applications.

All 3VA62 electronic trip circuit breakers are available with 100% ratings.

For 100% rated electronic trip circuit breakers, change the 13th digit of the catalog number to the number "2". (For example, a 35KA @480VAC, 100A, 3-pole, 100% rated 3VA62 would be catalog number 3VA6210-5HL31-**2**AA0) Requires the use of copper lugs — see lug table below.

All 3VA6 circuit breakers are certified to UL 489 Supplement SB, are marked "Naval", and are suitable for use at 50C.

## 3VA62 250A Frame 4-Pole Electronic Trip Unit

Continuous Ampere	M-Interrupting Class (MFAE-Y)	H-Interrupting Class (HFAE-Y)	C-Interrupting Class (CFAE-Y)	L-Interrupting Class (LFAE-Y)
	Catalog Number	Catalog Number	Catalog Number	Catalog Number
<b>ETU320 LI with dials</b>				
100	3VA6210-5HL41-0AA0	3VA6210-6HL41-0AA0	3VA6210-7HL41-0AA0	3VA6210-8HL41-0AA0
250	3VA6225-5HL41-0AA0	3VA6225-6HL41-0AA0	3VA6225-7HL41-0AA0	3VA6225-8HL41-0AA0
<b>ETU330 LIG with dials</b>				
100	3VA6210-5HM41-0AA0	3VA6210-6HM41-0AA0	3VA6210-7HM41-0AA0	3VA6210-8HM41-0AA0
250	3VA6225-5HM41-0AA0	3VA6225-6HM41-0AA0	3VA6225-7HM41-0AA0	3VA6225-8HM41-0AA0
<b>ETU350 LSI with dials</b>				
100	3VA6210-5HN41-0AA0	3VA6210-6HN41-0AA0	3VA6210-7HN41-0AA0	3VA6210-8HN41-0AA0
150	3VA6225-5HN41-0AA0	3VA6225-6HN41-0AA0	3VA6225-7HN41-0AA0	3VA6225-8HN41-0AA0
<b>ETU550 LSI with LCD</b>				
100	3VA6210-5JP41-0AA0	3VA6210-6JP41-0AA0	3VA6210-7JP41-0AA0	3VA6210-8JP41-0AA0
250	3VA6225-5JP41-0AA0	3VA6225-6JP41-0AA0	3VA6225-7JP41-0AA0	3VA6225-8JP41-0AA0
<b>ETU556 LSI(G Alarm) with LCD</b>				
100	3VA6210-5JT41-0AA0	3VA6210-6JT41-0AA0	3VA6210-7JT41-0AA0	3VA6210-8JT41-0AA0
250	3VA6225-5JT41-0AA0	3VA6225-6JT41-0AA0	3VA6225-7JT41-0AA0	3VA6225-8JT41-0AA0
<b>ETU560 LSIG with LCD</b>				
100	3VA6210-5JQ41-0AA0	3VA6210-6JQ41-0AA0	3VA6210-7JQ41-0AA0	3VA6210-8JQ41-0AA0
250	3VA6225-5JQ41-0AA0	3VA6225-6JQ41-0AA0	3VA6225-7JQ41-0AA0	3VA6225-8JQ41-0AA0
<b>ETU820 LI with LCD and Metering</b>				
100	3VA6210-5KL41-0AA0	3VA6210-6KL41-0AA0	3VA6210-7KL41-0AA0	3VA6210-8KL41-0AA0
250	3VA6225-5KL41-0AA0	3VA6225-6KL41-0AA0	3VA6225-7KL41-0AA0	3VA6225-8KL41-0AA0
<b>ETU830 LIG with LCD and Metering</b>				
100	3VA6210-5KM41-0AA0	3VA6210-6KM41-0AA0	3VA6210-7KM41-0AA0	3VA6210-8KM41-0AA0
250	3VA6225-5KM41-0AA0	3VA6225-6KM41-0AA0	3VA6225-7KM41-0AA0	3VA6225-8KM41-0AA0
<b>ETU850 LSI with LCD and Metering</b>				
100	3VA6210-5KP41-0AA0	3VA6210-6KP41-0AA0	3VA6210-7KP41-0AA0	3VA6210-8KP41-0AA0
250	3VA6225-5KP41-0AA0	3VA6225-6KP41-0AA0	3VA6225-7KP41-0AA0	3VA6225-8KP41-0AA0
<b>ETU856 LSI(G Alarm) with LCD and Metering</b>				
100	3VA6210-5KT41-0AA0	3VA6210-6KT41-0AA0	3VA6210-7KT41-0AA0	3VA6210-8KT41-0AA0
250	3VA6225-5KT41-0AA0	3VA6225-6KT41-0AA0	3VA6225-7KT41-0AA0	3VA6225-8KT41-0AA0
<b>ETU860 LSIG with LCD and Metering</b>				
100	3VA6210-5KQ41-0AA0	3VA6210-6KQ41-0AA0	3VA6210-7KQ41-0AA0	3VA6210-8KQ41-0AA0
250	3VA6225-5KQ41-0AA0	3VA6225-6KQ41-0AA0	3VA6225-7KQ41-0AA0	3VA6225-8KQ41-0AA0

# 3VA Molded Case Circuit Breakers

## 3VA62 250A Electronic Trip Circuit Breakers

*Technical information*

### Connectors for 75C wire for 3VA62

Type	Minimum cable size	Maximum cable size	Part Number (kit of 3 lugs)	Part Number (kit of 4 lugs)
Steel Wrap around (Cu cable only) single cable lugs	AWG 10	3/0	3VA9143-0JA12	3VA9144-0JA12
	AWG 4	350 kcmil	3VA9243-0JA12	3VA9244-0JA12
Aluminum Body Lug (Cu/Al cable) single cable lugs	AWG 14	1/0	3VA9143-0JB11	3VA9144-0JB11
	AWG 6	350 kcmil	3VA9243-0JB12	3VA9244-0JB12
Aluminum body lug with control wire tap (Cu/Al cable) single cable lugs	AWG 14	1/0	3VA9143-0JG11	3VA9144-0JG11
	AWG 6	350 kcmil	3VA9243-0JG12	3VA9244-0JG12
Aluminum body lug large (Cu/Al cable) single cable lugs and 1 ext'd terminal cover	AWG 2	350 kcmil	3VA9243-0JJ13	3VA9244-0JJ13
Aluminum body lug large with control wire tap (Cu/Al cable) single cable lugs and 1 extended terminal cover	AWG 2	350 kcmil	3VA9243-0JC13	3VA9244-0JC13
Aluminum body lug, 2 cables (Cu/Al cable) with 1 extended terminal cover	AWG 4	300 kcmil	3VA9243-0JJ22	3VA9244-0JJ22
Aluminum body lug, 2 cables (Cu/Al cable) with control wire tap and 1 extended terminal cover	AWG 4	300 kcmil	3VA9243-0JC22	3VA9244-0JC22
Distribution lug, 6 Cables (Cu/Al cable) with 1 extended terminal cover	AWG 14	AWG 2	3VA9243-0JF60	3VA9244-0JF60
Copper body lug (Cu cable only) single cable lugs (meets requirements for 100% rated breakers)	AWG 14	1/0	3VA9143-0JD11	3VA9144-0JD11
	AWG 6	350 kcmil	3VA9243-0JD12	3VA9244-0JD12
Copper body lug (Cu cable only) with control wire tap single cable lugs	AWG 14	1/0	3VA9143-0JK11	3VA9144-0JK11
	AWG 6	350 kcmil	3VA9243-0JK12	3VA9244-0JK12

### Interrupting Ratings for 3VA62

Interrupting Class	Breaker Type	RMS Symmetrical Amperes (kA)				
		Volts AC (50/60 Hz)				
		240	480Y/277V	480	600Y/347V	600
M	MFAE-Y	100	35	35	18	—
H	HFAE-Y	100	65	65	22	—
C	CFAE-Y	200	100	100	35	—
L	LFAE-Y	200	150	150	50	—

### Enclosures (3-pole only)

Nema Type	Catalog Number
1 surface	3VAE250N1S
1 flush	3VAE250N1F
3R	3VAE250N3R
12	3VAE250N12
4X (304)	3VAE250N4X
4X (316)	3VAE250N4X316
Neutral	N250X
200% Neutral	N2250X

### Dimensions

Breaker	Poles	W in. (mm)	H in. (mm)	D in. (mm)	lbs.	kg
3VA62	3	4.1 (105)	7.8 (198)	3.4 (86)	5.5	2.5
3VA62	4	5.5 (140)	7.8 (198)	3.4 (86)	7.1	3.2

### Shipping Weight

# 3VA Molded Case Circuit Breakers

## 3VA62 250A Electronic Trip Circuit Breakers

Technical information

### Trip Settings for 3VA62

ETU320-LI, ETU330-LIG, ETU350-LSI

Continuous Amperage	LI, LIG, LSI			LSI		LIG	LI, LIG, LSI 4P only
$I_n$ (Amp)	$I_r$ (Amp) (L)	$t_{td}$ (sec) (L)	$I_i$ (Amp) (I)①	$I_{sd} = xI_r$ (Amp) (S)	$t_{sd}$ (sec) (S)	$I_g$ (Amp) (G)	$I_N = xI_r$ (Amp)
100	40 - 100	0.5 - 17	150-1200	1.5 - 10	0.08 - 0.4	20 - 100	0.5 - 1 / OFF
250	100 - 250	0.5 - 13	375-2500	1.5 - 10		50 - 250	0.5 - 1 / OFF

①  $I_i$  for ETU350 is fixed at 12X  $I_n$

ETU550-LSI, ETU556 LSI(A), ETU560-LSIG, ETU820-LI, ETU830-LIG, ETU850-LSI, ETU856 LSI(A), ETU860-LSIG

Continuous Amperage	LI, LIG, LSI, LSIG, LSI(G)			LSI, LSIG, LSI(G)		LIG, LSIG, LSI(G)		LSI 3P with External CT	LI, LIG, LSI, LSIG, LSI(G) 4P only
$I_n$ (Amp)	$I_r$ (Amp) (L)	$t_{td}$ (sec) (L)	$I_i$ (Amp) (I)	$I_{sd}$ (Amp) (S)	$t_{sd}$ (sec) (S)	$I_g$ (Amp) (G)	$t_g$ (G)	$I_N = xI_r$ (Amp)	$I_N$ (Amp)
100	40 - 100	0.5 - 25	150-1200	60 - 1000	0.05 - 0.5	20 - 100	0.05 - 0.8	20 - 160 / OFF	20 - 160 / OFF
250	100 - 250	0.5 - 13	375-2500	150 - 2500		50 - 250		50 - 400 / OFF	50 - 250 / OFF

Internal accessories Optional equipment	Slot No.:	3VA6 150/250 A 3-pole	3VA6 150/250 A 4-pole
		24 23 22 21 11 12 13 14	34 33 32 31 24 23 22 21 11 12 13 14
<b>Auxiliary switch</b>	Type		
Auxiliary switch	AUX_HQ	x x x x x x x x	x x x x x x x x
	AUX_HQ_el	x x x x x x x x	x x x x x x x x
	AUX_HP	x x x x x x x x	x x x x x x x x
Leading changeover switch	LCS_HQ		
	LCS_HQ_el		
	LCS_HP		
<b>Alarm switch</b>	Type		
Trip alarm switch	TAS_HQ	x x x x x x	x x x x x x
	TAS_HQ_el	x x x x x x	x x x x x x
	TAS_HP	x x x x x x	x x x x x x
Electrical alarm switch	EAS_HQ		
	EAS_HQ_el		
<b>Auxiliary release</b>	Type		
Shunt trip flexible	STF	x x x x x x	x x x x x x
Shunt trip left	STL	x x x x x x	x x x x x x
Undervoltage release	UVR	x x x x x x	x x x x x x
Universal release	UNI	x x x x x x	x x x x x x
<b>ETU/communication</b>	Type		
Communication module	COM060		
Breaker data server			
24 V module			
<b>Other</b>			
Cylinder lock (type Ronis)			

See page 7-65 for internal accessory part numbers.

# 3VA Molded Case Circuit Breakers

## 3VA63 400A Electronic Trip Circuit Breakers

Selection



3VA63 400A 3-Pole

### Ordering Information

The catalog numbers listed below are for complete, non-interchangeable trip circuit breakers without lugs.

Order required lugs or connection technology separately for field installation.

All 3VA63 electronic trip circuit breakers are UL listed for reverse feed applications.

3VA63 electronic trip circuit breakers are available with 100% ratings (250A only).

For 100% rated electronic trip circuit breakers, change the 13th digit of the catalog number to the number "2". (For example, a 35KA @480VAC, 250A, 3-pole, 100% rated 3VA63 would be catalog number 3VA6325-5HL31-**2**AA0) Requires the use of copper lugs — see lug table below.

All 3VA6 circuit breakers are certified to UL 489 Supplement SB, are marked "Naval", and are suitable for use at 50C.

## 3VA63 400A Frame 3-Pole Electronic Trip Unit

Continuous Ampere	M-Interrupting Class (MJAE)	H-Interrupting Class (HJAE)	C-Interrupting Class (CJAE)	L-Interrupting Class (LJAE)
	Catalog Number	Catalog Number	Catalog Number	Catalog Number
<b>ETU320 LI with dials</b>				
250	3VA6325-5HL31-0AA0	3VA6325-6HL31-0AA0	3VA6325-7HL31-0AA0	3VA6325-8HL31-0AA0
400	3VA6340-5HL31-0AA0	3VA6340-6HL31-0AA0	3VA6340-7HL31-0AA0	3VA6340-8HL31-0AA0
<b>ETU330 LIG with dials</b>				
250	3VA6325-5HM31-0AA0	3VA6325-6HM31-0AA0	3VA6325-7HM31-0AA0	3VA6325-8HM31-0AA0
400	3VA6340-5HM31-0AA0	3VA6340-6HM31-0AA0	3VA6340-7HM31-0AA0	3VA6340-8HM31-0AA0
<b>ETU350 LSI with dials</b>				
250	3VA6325-5HN31-0AA0	3VA6325-6HN31-0AA0	3VA6325-7HN31-0AA0	3VA6325-8HN31-0AA0
400	3VA6340-5HN31-0AA0	3VA6340-6HN31-0AA0	3VA6340-7HN31-0AA0	3VA6340-8HN31-0AA0
<b>ETU550 LSI with LCD</b>				
250	3VA6325-5JP31-0AA0	3VA6325-6JP31-0AA0	3VA6325-7JP31-0AA0	3VA6325-8JP31-0AA0
400	3VA6340-5JP31-0AA0	3VA6340-6JP31-0AA0	3VA6340-7JP31-0AA0	3VA6340-8JP31-0AA0
<b>ETU556 LSI(G Alarm) with LCD</b>				
250	3VA6325-5JT31-0AA0	3VA6325-6JT31-0AA0	3VA6325-7JT31-0AA0	3VA6325-8JT31-0AA0
400	3VA6340-5JT31-0AA0	3VA6340-6JT31-0AA0	3VA6340-7JT31-0AA0	3VA6340-8JT31-0AA0
<b>ETU560 LSI(G) with LCD</b>				
250	3VA6325-5JQ31-0AA0	3VA6325-6JQ31-0AA0	3VA6325-7JQ31-0AA0	3VA6325-8JQ31-0AA0
400	3VA6340-5JQ31-0AA0	3VA6340-6JQ31-0AA0	3VA6340-7JQ31-0AA0	3VA6340-8JQ31-0AA0
<b>ETU820 LI with LCD and Metering</b>				
250	3VA6325-5KL31-0AA0	3VA6325-6KL31-0AA0	3VA6325-7KL31-0AA0	3VA6325-8KL31-0AA0
400	3VA6340-5KL31-0AA0	3VA6340-6KL31-0AA0	3VA6340-7KL31-0AA0	3VA6340-8KL31-0AA0
<b>ETU830 LIG with LCD and Metering</b>				
250	3VA6325-5KM31-0AA0	3VA6325-6KM31-0AA0	3VA6325-7KM31-0AA0	3VA6325-8KM31-0AA0
400	3VA6340-5KM31-0AA0	3VA6340-6KM31-0AA0	3VA6340-7KM31-0AA0	3VA6340-8KM31-0AA0
<b>ETU850 LSI with LCD and Metering</b>				
250	3VA6325-5KP31-0AA0	3VA6325-6KP31-0AA0	3VA6325-7KP31-0AA0	3VA6325-8KP31-0AA0
400	3VA6340-5KP31-0AA0	3VA6340-6KP31-0AA0	3VA6340-7KP31-0AA0	3VA6340-8KP31-0AA0
<b>ETU856 LSI(G Alarm) with LCD and Metering</b>				
250	3VA6325-5KT31-0AA0	3VA6325-6KT31-0AA0	3VA6325-7KT31-0AA0	3VA6325-8KT31-0AA0
400	3VA6340-5KT31-0AA0	3VA6340-6KT31-0AA0	3VA6340-7KT31-0AA0	3VA6340-8KT31-0AA0
<b>ETU860 LSI(G) with LCD and Metering</b>				
250	3VA6325-5KQ31-0AA0	3VA6325-6KQ31-0AA0	3VA6325-7KQ31-0AA0	3VA6325-8KQ31-0AA0
400	3VA6340-5KQ31-0AA0	3VA6340-6KQ31-0AA0	3VA6340-7KQ31-0AA0	3VA6340-8KQ31-0AA0



# 3VA Molded Case Circuit Breakers

## 3VA63 400A Electronic Trip Circuit Breakers

Selection



3VA63 400A 4-Pole

### Ordering Information

The catalog numbers listed below are for complete, non-interchangeable trip circuit breakers without lugs.

Order required lugs or connection technology separately for field installation.

All 3VA63 electronic trip circuit breakers are UL listed for reverse feed applications.

3VA63 electronic trip circuit breakers are available with 100% ratings (250A only).

For 100% rated electronic trip circuit breakers, change the 13th digit of the catalog number to the number "2". (For example, a 35KA @480VAC, 250A, 3-pole, 100% rated 3VA63 would be catalog number 3VA6325-5HL31-**2**AA0) Requires the use of copper lugs — see lug table below.

All 3VA6 circuit breakers are certified to UL 489 Supplement SB, are marked "Naval", and are suitable for use at 50C.

## 3VA63 400A Frame 4-Pole Electronic Trip Unit

Continuous Ampere	M-Interrupting Class (MJAE)	H-Interrupting Class (HJAE)	C-Interrupting Class (CJAE)	L-Interrupting Class (LJAE)
	Catalog Number	Catalog Number	Catalog Number	Catalog Number
<b>ETU320 LI with dials</b>				
250	3VA6325-5HL41-0AA0	3VA6325-6HL41-0AA0	3VA6325-7HL41-0AA0	3VA6325-8HL41-0AA0
400	3VA6340-5HL41-0AA0	3VA6340-6HL41-0AA0	3VA6340-7HL41-0AA0	3VA6340-8HL41-0AA0
<b>ETU330 LIG with dials</b>				
250	3VA6325-5HM41-0AA0	3VA6325-6HM41-0AA0	3VA6325-7HM41-0AA0	3VA6325-8HM41-0AA0
400	3VA6340-5HM41-0AA0	3VA6340-6HM41-0AA0	3VA6340-7HM41-0AA0	3VA6340-8HM41-0AA0
<b>ETU350 LSI with dials</b>				
250	3VA6325-5HN41-0AA0	3VA6325-6HN41-0AA0	3VA6325-7HN41-0AA0	3VA6325-8HN41-0AA0
400	3VA6340-5HN41-0AA0	3VA6340-6HN41-0AA0	3VA6340-7HN41-0AA0	3VA6340-8HN41-0AA0
<b>ETU550 LSI with LCD</b>				
250	3VA6325-5JP41-0AA0	3VA6325-6JP41-0AA0	3VA6325-7JP41-0AA0	3VA6325-8JP41-0AA0
400	3VA6340-5JP41-0AA0	3VA6340-6JP41-0AA0	3VA6340-7JP41-0AA0	3VA6340-8JP41-0AA0
<b>ETU556 LSI(G Alarm) with LCD</b>				
250	3VA6325-5JT41-0AA0	3VA6325-6JT41-0AA0	3VA6325-7JT41-0AA0	3VA6325-8JT41-0AA0
400	3VA6340-5JT41-0AA0	3VA6340-6JT41-0AA0	3VA6340-7JT41-0AA0	3VA6340-8JT41-0AA0
<b>ETU560 LSIG with LCD</b>				
250	3VA6325-5JQ41-0AA0	3VA6325-6JQ41-0AA0	3VA6325-7JQ41-0AA0	3VA6325-8JQ41-0AA0
400	3VA6340-5JQ41-0AA0	3VA6340-6JQ41-0AA0	3VA6340-7JQ41-0AA0	3VA6340-8JQ41-0AA0
<b>ETU820 LI with LCD and Metering</b>				
250	3VA6325-5KL41-0AA0	3VA6325-6KL41-0AA0	3VA6325-7KL41-0AA0	3VA6325-8KL41-0AA0
400	3VA6340-5KL41-0AA0	3VA6340-6KL41-0AA0	3VA6340-7KL41-0AA0	3VA6340-8KL41-0AA0
<b>ETU830 LIG with LCD and Metering</b>				
250	3VA6325-5KM41-0AA0	3VA6325-6KM41-0AA0	3VA6325-7KM41-0AA0	3VA6325-8KM41-0AA0
400	3VA6340-5KM41-0AA0	3VA6340-6KM41-0AA0	3VA6340-7KM41-0AA0	3VA6340-8KM41-0AA0
<b>ETU850 LSI with LCD and Metering</b>				
250	3VA6325-5KP41-0AA0	3VA6325-6KP41-0AA0	3VA6325-7KP41-0AA0	3VA6325-8KP41-0AA0
400	3VA6340-5KP41-0AA0	3VA6340-6KP41-0AA0	3VA6340-7KP41-0AA0	3VA6340-8KP41-0AA0
<b>ETU856 LSI(G Alarm) with LCD and Metering</b>				
250	3VA6325-5KT41-0AA0	3VA6325-6KT41-0AA0	3VA6325-7KT41-0AA0	3VA6325-8KT41-0AA0
400	3VA6340-5KT41-0AA0	3VA6340-6KT41-0AA0	3VA6340-7KT41-0AA0	3VA6340-8KT41-0AA0
<b>ETU860 LSIG with LCD and Metering</b>				
250	3VA6325-5KQ41-0AA0	3VA6325-6KQ41-0AA0	3VA6325-7KQ41-0AA0	3VA6325-8KQ41-0AA0
400	3VA6340-5KQ41-0AA0	3VA6340-6KQ41-0AA0	3VA6340-7KQ41-0AA0	3VA6340-8KQ41-0AA0

# 3VA Molded Case Circuit Breakers

## 3VA63 400A Electronic Trip Circuit Breakers

Technical information

### Connectors for 75C wire for 3VA63

Type	Minimum cable size	Maximum cable size	Part Number (kit of 3 lugs)	Part Number (kit of 4 lugs)
Steel wrap around (Cu cable only) single cable lugs	1/0	500 kcmil	3VA9473-0JA13	3VA9474-0JA13
Aluminum body lug (Cu/Al cable) single cable lugs	AWG 1	600 kcmil	3VA9373-0JB13	3VA9374-0JB13
Aluminum body lug with control wire tap (Cu/Al cable) single cable lugs	AWG 1	600 kcmil	3VA9373-0JG13	3VA9374-0JG13
Aluminum body lug, 2 cables (Cu/Al cable) with 1 extended terminal cover	2/0	600 kcmil	3VA9473-0JJ23	3VA9474-0JJ23
Aluminum body lug, 2 cables (Cu/Al cable) with control wire tap and 1 extended terminal cover	2/0	600 kcmil	3VA9473-0JC23	3VA9474-0JC23
Distribution lug, 6 Cables (Cu/Al cable) with 1 extended terminal cover	AWG 14	AWG 2	3VA9373-0JF60	3VA9374-0JF60
Copper body lug (Cu cable only) single cable lugs (meets requirements for 100% rated breakers)	AWG 1	600 kcmil	3VA9373-0JD13	3VA9374-0JD13
Copper body lug (Cu cable only) with control wire tap single cable lugs	AWG 1	600 kcmil	3VA9373-0JK13	3VA9374-0JK13
Copper body lug, 2 cables (Cu cable only) with 1 extended terminal cover (meets requirements for 100% rated breakers)	2/0	600 kcmil	3VA9473-0JE23	3VA9474-0JE23
Copper body lug, 2 cables (Cu cable only) with control wire tap and 1 extended terminal cover	2/0	600 kcmil	3VA9473-0JL23	3VA9474-0JL23

### Interrupting Ratings for 3VA63

Interrupting Class	Breaker Type	RMS Symmetrical Amperes (kA)				
		Volts AC (50/60 Hz)				
		240	480Y/277V	480	600Y/347V	600
M	MJAE	100	35	35	18	18
H	HJAE	100	65	65	22	22
C	CJAE	200	100	100	35	35
L	LJAE	200	150	150	50	50

### Enclosures (3-pole only)

Nema Type	Catalog Number
1 surface	
1 flush	
3R	
12	
4X (304)	
4X (316)	
Neutral	
200% Neutral	

### Dimensions

Breaker	Poles	W in. (mm)	H in. (mm)	D in. (mm)	lbs.	kg
3VA63	3	5.4 (138)	9.7 (248)	4.3 (110)	9.9	4.5
3VA63	4	7.2 (184)	9.7 (248)	4.3 (110)	15.2	6.9

### Shipping Weight

# 3VA Molded Case Circuit Breakers

## 3VA63 400A Electronic Trip Circuit Breakers

Technical information

### Trip Settings for 3VA63

ETU320-LI, ETU330-LIG, ETU350-LSI

Continuous Amperage	LI, LIG, LSI			LSI		LIG	LI, LIG, LSI 4P only
$I_n$ (Amp)	$I_r$ (Amp) (L)	$t_{td}$ (sec) (L)	$I_i$ (Amp) (I)①	$I_{sd} = xI_r$ (Amp) (S)	$t_{sd}$ (sec) (S)	$I_g$ (Amp) (G)	$I_N = xI_r$ (Amp)
250	100 - 250	0.5 - 17	375-3000	1.5 - 10	0.08 - 0.4	50 - 250	0.5 - 1 / OFF
400	150 - 400	0.5 - 17	600-4000	1.5 - 10		80 - 400	0.5 - 1 / OFF

①  $I_i$  for ETU350 is fixed at 12X  $I_n$

ETU550-LSI, ETU556 LSI(A), ETU560-LSIG, ETU820-LI, ETU830-LIG, ETU850-LSI, ETU856 LSI(A), ETU860-LSIG

Continuous Amperage	LI, LIG, LSI, LSIG, LSI(G)			LSI, LSIG, LSI(G)		LIG, LSIG, LSI(G)		LSI 3P with External CT	LI, LIG, LSI, LSIG, LSI(G) 4P only
$I_n$ (Amp)	$I_r$ (Amp) (L)	$t_{td}$ (sec) (L)	$I_i$ (Amp) (I)	$I_{sd}$ (Amp) (S)	$t_{sd}$ (sec) (S)	$I_g$ (Amp) (G)	$t_g$ (G)	$I_N = xI_r$ (Amp)	$I_N$ (Amp)
250	100 - 250	0.5 - 25	375-3000	150 - 2500	0.05 - 0.5	50 - 250	0.05 - 0.8	50 - 400 / OFF	50 - 400 / OFF
400	150 - 400	0.5 - 17	600-4000	240 - 4000		80 - 400		80 - 640 / OFF	80 - 400 / OFF

Internal accessories Optional equipment	Slot No.:	3VA6 400/600 A 3-pole											3VA6 400/600 A 4-pole													
		25	24	23	22	21	11	12	13	14	15	35	34	33	32	31	25	24	23	22	21	11	12	13	14	15
Auxiliary switch	Type																									
	AUX_HQ	x	x	x	x	x		x	x	x	x	x		x	x	x	x	x	x		x	x	x	x	x	
Auxiliary switch	AUX_HQ_el	x	x	x	x	x		x	x	x	x	x		x	x	x	x	x	x		x	x	x	x	x	
	AUX_HP	x	x					x	x					x	x							x	x			
	LCS_HQ							x																		
Leading changeover switch	LCS_HQ_el							x																		
	LCS_HP																									
Alarm switch	Type																									
	TAS_HQ			x	x			x	x																	
Trip alarm switch	TAS_HQ_el			x	x			x	x																	
	TAS_HP			x				x																		
Electrical alarm switch	EAS_HQ																									x
	EAS_HQ_el																									x
Auxiliary release	Type																									
	STF							x																		x
	STL							x																		
	UVR							x																		
	UNI							x																		
ETU/communication	Type																									
	COM060																									
	Breaker data server																									x
	24 V module																									x
Other																										
	Cylinder lock (type Ronis)																									x

See page 7-65 for internal accessory part numbers.

7  
MOLDED CASE  
CIRCUIT BREAKERS

# 3VA Molded Case Circuit Breakers

## 3VA64 600A Electronic Trip Circuit Breakers

Selection



3VA64 600A 3-Pole

### Ordering Information

The catalog numbers listed below are for complete, non-interchangeable trip circuit breakers without lugs.

Order required lugs or connection technology separately for field installation.

All 3VA64 electronic trip circuit breakers are UL listed for reverse feed applications.

3VA64 electronic trip circuit breakers are available with 100% ratings (400A only).

For 100% rated electronic trip circuit breakers, change the 13th digit of the catalog number to the number "2". (For example, a 35KA @480VAC, 400A, 3-pole, 100% rated 3VA64 would be catalog number 3VA6440-5HL31-**2**AA0) Requires the use of copper lugs — see lug table below.

All 3VA6 circuit breakers are certified to UL 489 Supplement SB, are marked "Naval", and are suitable for use at 50C.

## 3VA64 600A Frame 3-Pole Electronic Trip Unit

Continuous Ampere	M-Interrupting Class (MLAE)	H-Interrupting Class (HLAE)	C-Interrupting Class (CLAE)	L-Interrupting Class (LLAE)
	Catalog Number	Catalog Number	Catalog Number	Catalog Number
<b>ETU320 LI with dials</b>				
400	3VA6440-5HL31-0AA0	3VA6440-6HL31-0AA0	3VA6440-7HL31-0AA0	3VA6440-8HL31-0AA0
600	3VA6460-5HL31-0AA0	3VA6460-6HL31-0AA0	3VA6460-7HL31-0AA0	3VA6460-8HL31-0AA0
<b>ETU330 LIG with dials</b>				
400	3VA6440-5HM31-0AA0	3VA6440-6HM31-0AA0	3VA6440-7HM31-0AA0	3VA6440-8HM31-0AA0
600	3VA6460-5HM31-0AA0	3VA6460-6HM31-0AA0	3VA6460-7HM31-0AA0	3VA6460-8HM31-0AA0
<b>ETU350 LSI with dials</b>				
400	3VA6440-5HN31-0AA0	3VA6440-6HN31-0AA0	3VA6440-7HN31-0AA0	3VA6440-8HN31-0AA0
600	3VA6460-5HN31-0AA0	3VA6460-6HN31-0AA0	3VA6460-7HN31-0AA0	3VA6460-8HN31-0AA0
<b>ETU550 LSI with LCD</b>				
400	3VA6440-5JP31-0AA0	3VA6440-6JP31-0AA0	3VA6440-7JP31-0AA0	3VA6440-8JP31-0AA0
600	3VA6460-5JP31-0AA0	3VA6460-6JP31-0AA0	3VA6460-7JP31-0AA0	3VA6460-8JP31-0AA0
<b>ETU556 LSI(G Alarm) with LCD</b>				
400	3VA6440-5JT31-0AA0	3VA6440-6JT31-0AA0	3VA6440-7JT31-0AA0	3VA6440-8JT31-0AA0
600	3VA6460-5JT31-0AA0	3VA6460-6JT31-0AA0	3VA6460-7JT31-0AA0	3VA6460-8JT31-0AA0
<b>ETU560 LSI(G) with LCD</b>				
400	3VA6440-5JQ31-0AA0	3VA6440-6JQ31-0AA0	3VA6440-7JQ31-0AA0	3VA6440-8JQ31-0AA0
600	3VA6460-5JQ31-0AA0	3VA6460-6JQ31-0AA0	3VA6460-7JQ31-0AA0	3VA6460-8JQ31-0AA0
<b>ETU820 LI with LCD and Metering</b>				
400	3VA6440-5KL31-0AA0	3VA6440-6KL31-0AA0	3VA6440-7KL31-0AA0	3VA6440-8KL31-0AA0
600	3VA6460-5KL31-0AA0	3VA6460-6KL31-0AA0	3VA6460-7KL31-0AA0	3VA6460-8KL31-0AA0
<b>ETU830 LIG with LCD and Metering</b>				
400	3VA6440-5KM31-0AA0	3VA6440-6KM31-0AA0	3VA6440-7KM31-0AA0	3VA6440-8KM31-0AA0
600	3VA6460-5KM31-0AA0	3VA6460-6KM31-0AA0	3VA6460-7KM31-0AA0	3VA6460-8KM31-0AA0
<b>ETU850 LSI with LCD and Metering</b>				
400	3VA6440-5KP31-0AA0	3VA6440-6KP31-0AA0	3VA6440-7KP31-0AA0	3VA6440-8KP31-0AA0
600	3VA6460-5KP31-0AA0	3VA6460-6KP31-0AA0	3VA6460-7KP31-0AA0	3VA6460-8KP31-0AA0
<b>ETU856 LSI(G Alarm) with LCD and Metering</b>				
400	3VA6440-5KT31-0AA0	3VA6440-6KT31-0AA0	3VA6440-7KT31-0AA0	3VA6440-8KT31-0AA0
600	3VA6460-5KT31-0AA0	3VA6460-6KT31-0AA0	3VA6460-7KT31-0AA0	3VA6460-8KT31-0AA0
<b>ETU860 LSI(G) with LCD and Metering</b>				
400	3VA6440-5KQ31-0AA0	3VA6440-6KQ31-0AA0	3VA6440-7KQ31-0AA0	3VA6440-8KQ31-0AA0
600	3VA6460-5KQ31-0AA0	3VA6460-6KQ31-0AA0	3VA6460-7KQ31-0AA0	3VA6460-8KQ31-0AA0

# 3VA Molded Case Circuit Breakers

## 3VA64 600A Electronic Trip Circuit Breakers

Selection



3VA64 600A 4-Pole

### Ordering Information

The catalog numbers listed below are for complete, non-interchangeable trip circuit breakers without lugs.

Order required lugs or connection technology separately for field installation.

All 3VA64 electronic trip circuit breakers are UL listed for reverse feed applications.

3VA64 electronic trip circuit breakers are available with 100% ratings (400A only).

For 100% rated electronic trip circuit breakers, change the 13th digit of the catalog number to the number "2". (For example, a 35KA @480VAC, 400A, 3-pole, 100% rated 3VA64 would be catalog number 3VA6440-5HL31-**2**AA0) Requires the use of copper lugs — see lug table below.

All 3VA6 circuit breakers are certified to UL 489 Supplement SB, are marked "Naval", and are suitable for use at 50C.

## 3VA64 600A Frame 4-Pole Electronic Trip Unit

Continuous Ampere	M-Interrupting Class (MLAE)	H-Interrupting Class (HLAE)	C-Interrupting Class (CLAE)	L-Interrupting Class (LLAE)
	Catalog Number	Catalog Number	Catalog Number	Catalog Number
<b>ETU320 LI with dials</b>				
400	3VA6440-5HL41-0AA0	3VA6440-6HL41-0AA0	3VA6440-7HL41-0AA0	3VA6440-8HL41-0AA0
600	3VA6460-5HL41-0AA0	3VA6460-6HL41-0AA0	3VA6460-7HL41-0AA0	3VA6460-8HL41-0AA0
<b>ETU330 LIG with dials</b>				
400	3VA6440-5HM41-0AA0	3VA6440-6HM41-0AA0	3VA6440-7HM41-0AA0	3VA6440-8HM41-0AA0
600	3VA6460-5HM41-0AA0	3VA6460-6HM41-0AA0	3VA6460-7HM41-0AA0	3VA6460-8HM41-0AA0
<b>ETU350 LSI with dials</b>				
400	3VA6440-5HN41-0AA0	3VA6440-6HN41-0AA0	3VA6440-7HN41-0AA0	3VA6440-8HN41-0AA0
600	3VA6460-5HN41-0AA0	3VA6460-6HN41-0AA0	3VA6460-7HN41-0AA0	3VA6460-8HN41-0AA0
<b>ETU550 LSI with LCD</b>				
400	3VA6440-5JP41-0AA0	3VA6440-6JP41-0AA0	3VA6440-7JP41-0AA0	3VA6440-8JP41-0AA0
600	3VA6460-5JP41-0AA0	3VA6460-6JP41-0AA0	3VA6460-7JP41-0AA0	3VA6460-8JP41-0AA0
<b>ETU556 LSI(G Alarm) with LCD</b>				
400	3VA6440-5JT41-0AA0	3VA6440-6JT41-0AA0	3VA6440-7JT41-0AA0	3VA6440-8JT41-0AA0
600	3VA6460-5JT41-0AA0	3VA6460-6JT41-0AA0	3VA6460-7JT41-0AA0	3VA6460-8JT41-0AA0
<b>ETU560 LSIG with LCD</b>				
400	3VA6440-5JQ41-0AA0	3VA6440-6JQ41-0AA0	3VA6440-7JQ41-0AA0	3VA6440-8JQ41-0AA0
600	3VA6460-5JQ41-0AA0	3VA6460-6JQ41-0AA0	3VA6460-7JQ41-0AA0	3VA6460-8JQ41-0AA0
<b>ETU820 LI with LCD and Metering</b>				
400	3VA6440-5KL41-0AA0	3VA6440-6KL41-0AA0	3VA6440-7KL41-0AA0	3VA6440-8KL41-0AA0
600	3VA6460-5KL41-0AA0	3VA6460-6KL41-0AA0	3VA6460-7KL41-0AA0	3VA6460-8KL41-0AA0
<b>ETU830 LIG with LCD and Metering</b>				
400	3VA6440-5KM41-0AA0	3VA6440-6KM41-0AA0	3VA6440-7KM41-0AA0	3VA6440-8KM41-0AA0
600	3VA6460-5KM41-0AA0	3VA6460-6KM41-0AA0	3VA6460-7KM41-0AA0	3VA6460-8KM41-0AA0
<b>ETU850 LSI with LCD and Metering</b>				
400	3VA6440-5KP41-0AA0	3VA6440-6KP41-0AA0	3VA6440-7KP41-0AA0	3VA6440-8KP41-0AA0
600	3VA6460-5KP41-0AA0	3VA6460-6KP41-0AA0	3VA6460-7KP41-0AA0	3VA6460-8KP41-0AA0
<b>ETU856 LSI(G Alarm) with LCD and Metering</b>				
400	3VA6440-5KT41-0AA0	3VA6440-6KT41-0AA0	3VA6440-7KT41-0AA0	3VA6440-8KT41-0AA0
600	3VA6460-5KT41-0AA0	3VA6460-6KT41-0AA0	3VA6460-7KT41-0AA0	3VA6460-8KT41-0AA0
<b>ETU860 LSIG with LCD and Metering</b>				
400	3VA6440-5KQ41-0AA0	3VA6440-6KQ41-0AA0	3VA6440-7KQ41-0AA0	3VA6440-8KQ41-0AA0
600	3VA6460-5KQ41-0AA0	3VA6460-6KQ41-0AA0	3VA6460-7KQ41-0AA0	3VA6460-8KQ41-0AA0

# 3VA Molded Case Circuit Breakers

## 3VA64 600A Electronic Trip Circuit Breakers

Technical information

### Connectors for 75C wire for 3VA64

Type	Minimum cable size	Maximum cable size	Part Number (kit of 3 lugs)	Part Number (kit of 4 lugs)
Steel Wrap around (Cu cable only) single cable lugs	1/0	500 kcmil	3VA9473-0JA13	3VA9474-0JA13
Aluminum Body Lug (Cu/Al cable) single cable lugs	AWG 1	600 kcmil	3VA9373-0JB13	3VA9374-0JB13
Aluminum body lug with control wire tap (Cu/Al cable) single cable lugs	AWG 1	600 kcmil	3VA9373-0JG13	3VA9374-0JG13
Aluminum body lug, 2 cables (Cu/Al cable) with 1 extended terminal cover	2/0	600 kcmil	3VA9473-0JJ23	3VA9474-0JJ23
Aluminum body lug, 2 cables (Cu/Al cable) with control wire tap and 1 extended terminal cover	2/0	600 kcmil	3VA9473-0JC23	3VA9474-0JC23
Distribution lug, 6 Cables (Cu/Al cable) with 1 extended terminal cover	AWG 14	AWG 2	3VA9373-0JF60	3VA9374-0JF60
Copper body lug (Cu cable only) single cable lugs (meets requirements for 100% rated breakers)	AWG 1	600 kcmil	3VA9373-0JD13	3VA9374-0JD13
Copper body lug (Cu cable only) with control wire tap single cable lugs	AWG 1	600 kcmil	3VA9373-0JK13	3VA9374-0JK13
Copper body lug, 2 cables (Cu cable only) with 1 extended terminal cover (meets requirements for 100% rated breakers)	2/0	600 kcmil	3VA9473-0JE23	3VA9474-0JE23
Copper body lug, 2 cables (Cu cable only) with control wire tap and 1 extended terminal cover	2/0	600 kcmil	3VA9473-0JL23	3VA9474-0JL23

### Interrupting Ratings for 3VA64

Interrupting Class	Breaker Type	RMS Symmetrical Amperes (kA)				
		Volts AC (50/60 Hz)				
		240	480Y/277V	480	600Y/347V	600
M	MLAE	100	35	35	18	18
H	HLAE	100	65	65	22	22
C	CLAE	200	100	100	35	35
L	LLAE	200	150	150	50	50

### Enclosures (3-pole only)

Nema Type	Catalog Number
1 surface	TBD
1 flush	TBD
3R	TBD
12	TBD
4X (304)	TBD
4X (316)	TBD
Neutral	TBD
200% Neutral	TBD

### Dimensions

Breaker	Poles	W in. (mm)	H in. (mm)	D in. (mm)	lbs.	kg
3VA64	3	5.4 (138)	9.7 (248)	4.3 (110)	11.7	5.3
3VA64	4	7.2 (184)	9.7 (248)	4.3 (110)	15.2	6.9

### Shipping Weight

# 3VA Molded Case Circuit Breakers

## 3VA64 600A Electronic Trip Circuit Breakers

Technical information

### Trip Settings for 3VA64

ETU320-LI, ETU330-LIG, ETU350-LSI

Continuous Amperage	LI, LIG, LSI			LSI		LIG	LI, LIG, LSI 4P only
$I_n$ (Amp)	$I_r$ (Amp) (L)	$t_{td}$ (sec) (L)	$I_i$ (Amp) (I)①	$I_{sd} = xI_r$ (Amp) (S)	$t_{sd}$ (sec) (S)	$I_g$ (Amp) (G)	$I_N = xI_r$ (Amp)
400	150 - 400	0.5 - 17	600-4800	1.5 - 10	0.08 - 0.4	80 - 400	0.5 - 1 / OFF
600	250 - 600	0.5 - 15	900-5400	1.5 - 9		120 - 600	0.5 - 1 / OFF

①  $I_i$  for ETU350 is fixed at 12X  $I_n$

ETU550-LSI, ETU556 LSI(A), ETU560-LSIG, ETU820-LI, ETU830-LIG, ETU850-LSI, ETU856 LSI(A), ETU860-LSIG

Continuous Amperage	LI, LIG, LSI, LSIG, LSI(G)			LSI, LSIG, LSI(G)		LIG, LSIG, LSI(G)		LSI 3P with External CT	LI, LIG, LSI, LSIG, LSI(G) 4P only
$I_n$ (Amp)	$I_r$ (Amp) (L)	$t_{td}$ (sec) (L)	$I_i$ (Amp) (I)	$I_{sd}$ (Amp) (S)	$t_{sd}$ (sec) (S)	$I_g$ (Amp) (G)	$t_g$ (G)	$I_N = xI_r$ (Amp)	$I_N$ (Amp)
400	150 - 400	0.5 - 25	600-4800	240 - 4000	0.05 - 0.5	80 - 400	0.05 - 0.8	80 - 640 / OFF	80 - 600 / OFF
600	250 - 600	0.5 - 15	900-5400	360 - 5400		120 - 600		120 - 960 / OFF	120 - 600 / OFF

Internal accessories Optional equipment	Slot No.:	3VA6 400/600 A 3-pole											3VA6 400/600 A 4-pole													
		25	24	23	22	21	11	12	13	14	15	35	34	33	32	31	25	24	23	22	21	11	12	13	14	15
Auxiliary switch	Type																									
	AUX_HQ	x	x	x	x	x		x	x	x	x	x		x	x	x	x	x	x	x		x	x	x	x	x
Auxiliary switch	AUX_HQ_el	x	x	x	x	x		x	x	x	x	x		x	x	x	x	x	x	x		x	x	x	x	x
	AUX_HP	x	x					x	x					x	x			x	x			x	x			
	LCS_HQ							x																		
Leading changeover switch	LCS_HQ_el							x																		
	LCS_HP																									
Alarm switch	Type																									
	TAS_HQ			x	x			x	x																	
Trip alarm switch	TAS_HQ_el			x	x			x	x																	
	TAS_HP			x				x																		
Electrical alarm switch	EAS_HQ																									x
	EAS_HQ_el																									x
Auxiliary release	Type																									
	STF							x																		x
	STL							x																		
	UVR							x																		
	UNI							x																		
ETU/communication	Type																									
	COM060																									
Communication module	Breaker data server																									x
	24 V module																									x
Other																										
	Cylinder lock (type Ronis)																									x

See page 7-65 for internal accessory part numbers.

# 3VA Molded Case Circuit Breakers

## 3VA Molded Case Switch and Motor Circuit Protector

Selection

Breaking capacity (the SCCR rating) is the maximum permissible short circuit current at the installation location of the MCS in combination with an appropriate overload protective device.

### Molded Case Switch Magnetic

Frame	Max. Ampere Rating	Short-Circuit Current Rating		Instantaneous short circuit protection
		2-Pole Catalog Number	3-Pole Catalog Number	
3VA51	100	—	3VA5110-1BB31-0AA0 <sup>③</sup>	100k 480V 14k <sup>①</sup> 1600 A
3VA52	150	3VA5215-0BB61-0AA0 <sup>③</sup>	3VA5215-0BB31-0AA0 <sup>③</sup>	100k 65k 25k 2400 A
	250	3VA5225-0BB61-0AA0 <sup>③</sup>	3VA5225-0BB31-0AA0 <sup>③</sup>	100k 65k 25k 2500 A

3VA52	100	3VA5210-1BB61-0AA0 <sup>②</sup>	3VA5210-1BB31-0AA0 <sup>②</sup>	200k 100k 35k 2500 A
	150	3VA5215-1BB61-0AA0 <sup>②</sup>	3VA5215-1BB31-0AA0 <sup>②</sup>	200k 100k 35k 2400 A
	250	3VA5225-1BB61-0AA0 <sup>②</sup>	3VA5225-1BB31-0AA0 <sup>②</sup>	200k 100k 35k 2500 A



### Molded Case Switch Electronic<sup>②</sup>

Frame	Max. Ampere Rating	Short-Circuit Current Rating		Instantaneous short circuit protection
		2-Pole Catalog Number	3-Pole Catalog Number	
3VA63	400	—	3VA6340-1BB31-0AA0	200k 100k 35k 5600 A
3VA64	600	—	3VA6460-1BB31-0AA0	200k 100k 35k 5400 A



### Motor circuit protector TM120M AM<sup>③</sup>

Frame	Maximum Ampere Rating	3-Pole Catalog Number	Instantaneous short circuit protection
3VA51	15	3VA5195-1MU31-0AA0	45 ... 105
		3VA5195-1MH31-0AA0	75 ... 180
	25	3VA5125-1MU31-0AA0	75 ... 175
		3VA5125-1MH31-0AA0	125 ... 300
	30	3VA5130-1MU31-0AA0	90 ... 210
		3VA5130-1MH31-0AA0	150 ... 360
	40	3VA5140-1MU31-0AA0	120 ... 280
		3VA5140-1MH31-0AA0	200 ... 480
	50	3VA5150-1MU31-0AA0	150 ... 350
		3VA5150-1MH31-0AA0	250 ... 600
	70	3VA5170-1MU31-0AA0	210 ... 490
		3VA5170-1MH31-0AA0	350 ... 840
	80	3VA5180-1MU31-0AA0	240 ... 560
		3VA5180-1MH31-0AA0	400 ... 960
	90	3VA5190-1MU31-0AA0	270 ... 630
		3VA5190-1MH31-0AA0	450 ... 1080
	100	3VA5110-1MU31-0AA0	300 ... 700
		3VA5110-1MH31-0AA0	500 ... 1200
110	3VA5111-1MU31-0AA0	330 ... 770	
	3VA5111-1MH31-0AA0	550 ... 1320	
125	3VA5125-1MU31-0AA0	375 ... 875	
	3VA5125-1MH31-0AA0	625 ... 1500	
3VA52	150	3VA5215-0MU31-0AA0	450 ... 900
		3VA5215-0MH31-0AA0	900 ... 1800
	200	3VA5220-0MU31-0AA0	600 ... 1200
		3VA5220-0MH31-0AA0	1200 ... 2400



### Motor circuit protector ETU310M<sup>②</sup>

Frame	Maximum Ampere Rating	3-Pole Catalog Number	Instantaneous short circuit protection
3VA61	25	3VA6125-1MS31-0AA0	75 ... 375
	30	3VA6130-1MS31-0AA0	90 ... 450
	40	3VA6140-1MS31-0AA0	120 ... 600
	50	3VA6150-1MS31-0AA0	150 ... 750
	70	3VA6170-1MS31-0AA0	210 ... 1050
	80	3VA6180-1MS31-0AA0	240 ... 1050
	90	3VA6190-1MS31-0AA0	270 ... 1350
	100	3VA6110-1MS31-0AA0	300 ... 1500
3VA62	110	3VA6211-1MS31-0AA0	330 ... 1650
	125	3VA6212-1MS31-0AA0	375 ... 1875
	150	3VA6215-1MS31-0AA0	450 ... 2250
	200	3VA6220-1MS31-0AA0	600 ... 2400
3VA63	200	3VA6320-1MS31-0AA0	600 ... 3000
	250	3VA6325-1MS31-0AA0	750 ... 3750
3VA64	400	3VA6440-1MS31-0AA0	1200 ... 5200
	500	3VA6450-1MS31-0AA0	1500 ... 6000

### Motor circuit protector TM120M AM<sup>②</sup>

3VA52	150	3VA5215-1MU31-0AA0	450 ... 900
		3VA5215-1MH31-0AA0	900 ... 1800
	200	3VA5220-1MU31-0AA0	600 ... 1200
		3VA5220-1MH31-0AA0	1200 ... 2400

① Rated at 600 V/347 V AC.

② SCCR is 100kA at 480 V. SCCR rating is the maximum permissible short circuit current of the MCP in combination with an appropriate overload protection device.\*

③ SCCR is 65kA at 480 V. SCCR rating is the maximum permissible short circuit current of the MCP in combination with an appropriate overload protection device.



# 3VA Molded Case Circuit Breakers

## 3VA Internal Accessories

Selection

### Internal Accessories

#### Auxiliary and Alarm Switches

Switch Type	Catalog Number		
	HP High Power (2 slots)	HQ Compact (1 slot)	HQ Electronic <sup>①</sup> (1 slot)
Auxiliary Switch (AUX)	3VA9978-0AA11	3VA9978-0AA12	3VA9978-0AA13
Leading Changeover Switch (LCS)	3VA9978-0AB11	3VA9978-0AA22	3VA9978-0AA23
Trip Alarm Switch (TAS)	3VA9978-0AB11	3VA9978-0AB12	3VA9978-0AB13
Electronic Alarm (EAS)	—	3VA9978-0AB22	3VA9978-0AB23

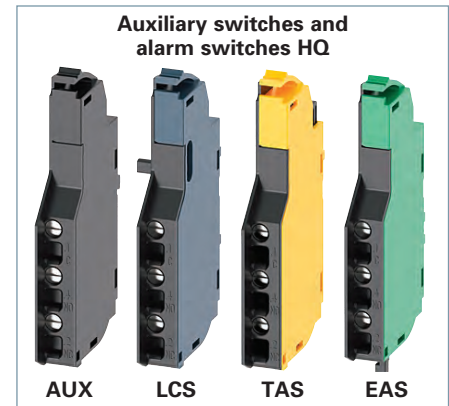

#### Shunt Trips

Type	VAC 50/60 Hz	VDC	Catalog Number (3 slots)
Shunt Trip Left (STL)	380 ... 600	—	3VA9978-0BL20
	—	12	3VA9978-0BL10
	24	24 ... 30	3VA9978-0BL30
	48 ... 60	—	3VA9978-0BL31
	110 ... 127	110 ... 127	3VA9978-0BL32
Shunt Trip Flexible (STF) <sup>②</sup>	208 ... 277	220 ... 250	3VA9978-0BL33
	24	—	3VA9978-0BA20
	48 ... 60	—	3VA9978-0BA21
	110 ... 127	—	3VA9978-0BA22
	208 ... 277	—	3VA9978-0BA23
	380 ... 500	—	3VA9978-0BA24
600	—	3VA9978-0BA25	

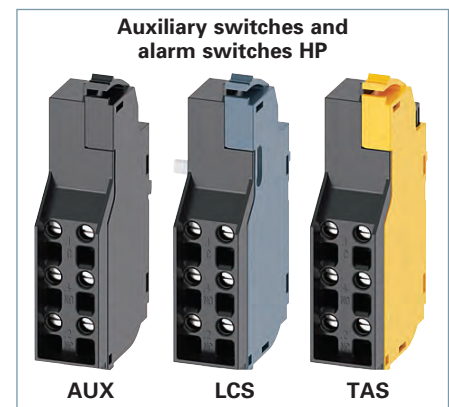

#### Undervoltage Release

Undervoltage Release (UVR)	—	12	3VA9978-0BB10
	—	24	3VA9978-0BB11
	—	48	3VA9978-0BB12
	—	125 ... 127	3VA9978-0BB14
	—	250	3VA9978-0BB16
	24	—	3VA9978-0BB20
	120 ... 127	—	3VA9978-0BB24
	208 ... 230	—	3VA9978-0BB25
	440 ... 480	—	3VA9978-0BB27

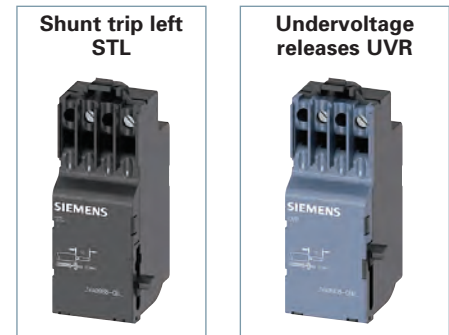

#### Universal Release (Undervoltage and Shunt trip)

Universal Release (UNI)	—	12	3VA9978-0BD11
	—	24	3VA9978-0BD12
	—	48	3VA9978-0BD13

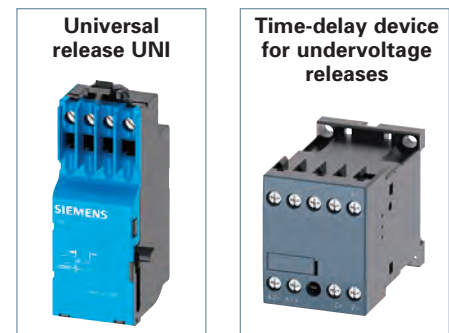

#### Time-delay Device for Undervoltage Release

Type	VAC 50/60 Hz	VDC	Delay Time	Catalog Number
Time-delay Device	230	230	Fixed – 100ms minimum	3VA9978-0BF22
	—	24	Fixed – 100ms minimum	3VA9978-0BF23

<sup>①</sup> Use only with 3VA6.



<sup>②</sup> Shunt trip flexible can be used in the left pocket of the 3VA5 breakers. They can be used in the left or right pocket of the 3VA6 breakers.

# 3VA Molded Case Circuit Breakers

3VA Manual Operators

Selection

## Front Mounted Rotary Operator

	Type	Color	3VA5 125A	3VA5 250A	3VA6 150A 250A	3VA6 400A 600A	Catalog Number
 <p>Degree of protection NEMA 1</p>	Standard without illumination kit	Gray	✓	—	—	—	3VA9137-0EK11
			—	✓	✓	—	3VA9277-0EK11
			—	—	—	✓	3VA9447-0EK11
	Standard with illumination kit	Gray	✓	—	—	—	3VA9137-0EK13
			—	✓	✓	—	3VA9277-0EK13
			—	—	—	✓	3VA9447-0EK13
	EMERGENCY-OFF without illumination kit	Yellow-Red	✓	—	—	—	3VA9137-0EK15
			—	✓	✓	—	3VA9277-0EK15
			—	—	—	✓	3VA9447-0EK15
	EMERGENCY-OFF with illumination kit	Yellow-Red	✓	—	—	—	3VA9137-0EK17
			—	✓	✓	—	3VA9277-0EK17
			—	—	—	✓	3VA9447-0EK17
	Standard with door interlock	Gray	✓	—	—	—	3VA9137-0EK21
			—	✓	✓	—	3VA9277-0EK21
			—	—	—	✓	3VA9447-0EK21
	Standard with door interlock, with illumination kit	Gray	✓	—	—	—	3VA9137-0EK23
			—	✓	✓	—	3VA9277-0EK23
			—	—	—	✓	3VA9447-0EK23
	EMERGENCY-OFF with door interlock	Yellow-Red	✓	—	—	—	3VA9137-0EK25
			—	✓	✓	—	3VA9277-0EK25
			—	—	—	✓	3VA9447-0EK25
	EMERGENCY-OFF with door interlock, with illumination kit	Yellow-Red	✓	—	—	—	3VA9137-0EK27
			—	✓	✓	—	3VA9277-0EK27
			—	—	—	✓	3VA9447-0EK27
Standard with door interlock, with door open function	Gray	✓	—	—	—	3VA9137-0EK31	
		—	✓	✓	—	3VA9277-0EK31	
		—	—	—	✓	3VA9447-0EK31	
Standard with door interlock, with door open function, with illumination kit	Gray	✓	—	—	—	3VA9137-0EK33	
		—	✓	✓	—	3VA9277-0EK33	
		—	—	—	✓	3VA9447-0EK33	
EMERGENCY-OFF with door interlock, with door open function	Yellow-Red	✓	—	—	—	3VA9137-0EK35	
		—	✓	✓	—	3VA9277-0EK35	
		—	—	—	✓	3VA9447-0EK35	
EMERGENCY-OFF with door interlock, with door open function, with illumination kit	Yellow-Red	✓	—	—	—	3VA9137-0EK37	
		—	✓	✓	—	3VA9277-0EK37	
		—	—	—	✓	3VA9447-0EK37	
 <p>Without handle, with shaft stub, without door interlock For retrofit with 3VL handle</p>	Gray	✓	—	—	—	3VA9137-0GK00	
		—	✓	✓	—	3VA9277-0GK00	
		—	—	—	✓	3VA9447-0GK00	

# 3VA Molded Case Circuit Breakers

3VA Manual Operators

Selection

## Door Mounted Rotary Operator<sup>①</sup>

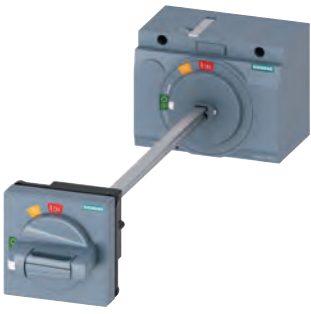
	Type	Color	3VA5	3VA5	3VA6	3VA6	Catalog Number
			125A	250A	150A 250A	400A 600A	
 <p>Degree of protection NEMA 1, 12, 3R</p>	Standard	Gray	✓	—	—	—	3VA9137-0FK21
			—	✓	✓	—	3VA9277-0FK21
			—	—	—	✓	3VA9447-0FK21
	Standard with illumination kit	Gray	✓	—	—	—	3VA9137-0FK23
			—	✓	✓	—	3VA9277-0FK23
			—	—	—	✓	3VA9447-0FK23
	EMERGENCY-OFF	Yellow-Red	✓	—	—	—	3VA9137-0FK25
			—	✓	✓	—	3VA9277-0FK25
			—	—	—	✓	3VA9447-0FK25
	EMERGENCY-OFF with illumination kit	Yellow-Red	✓	—	—	—	3VA9137-0FK27
			—	✓	✓	—	3VA9277-0FK27
			—	—	—	✓	3VA9447-0FK27
	Standard NEMA 1, 3R, 12, with door interlock, with open door function	Gray	✓	—	—	—	3VA9137-0FK31
			—	✓	✓	—	3VA9277-0FK31
			—	—	—	✓	3VA9447-0FK31
	Standard NEMA 1, 3R, 12, with door interlock, with open door function with illumination kit	Gray	✓	—	—	—	3VA9137-0FK33
			—	✓	✓	—	3VA9277-0FK33
			—	—	—	✓	3VA9447-0FK33
	EMERGENCY-OFF NEMA 1, 3R, 12, with door interlock, with open door function	Yellow-Red	✓	—	—	—	3VA9137-0FK35
			—	✓	✓	—	3VA9277-0FK35
			—	—	—	✓	3VA9447-0FK35
	EMERGENCY-OFF NEMA 1, 3R, 12, with door interlock, with open door function, with illumination kit	Yellow-Red	✓	—	—	—	3VA9137-0FK37
			—	✓	✓	—	3VA9277-0FK37
			—	—	—	✓	3VA9447-0FK37
Standard NEMA 4/4X, with door interlock, with door open function	Gray	✓	—	—	—	3VA9137-0FK41	
		—	✓	✓	—	3VA9277-0FK41	
		—	—	—	✓	3VA9447-0FK41	
Standard NEMA 4/4x with door interlock, with door open function, with illumination kit	Gray	✓	—	—	—	3VA9137-0FK43	
		—	✓	✓	—	3VA9277-0FK43	
		—	—	—	✓	3VA9447-0FK43	
EMERGENCY-OFF NEMA 4/4X, with door interlock, with door open function	Yellow-Red	✓	—	—	—	3VA9137-0FK45	
		—	✓	✓	—	3VA9277-0FK45	
		—	—	—	✓	3VA9447-0FK45	
EMERGENCY-OFF NEMA 4/4X, with door interlock, with door open function, with illumination kit	Yellow-Red	✓	—	—	—	3VA9137-0FK47	
		—	✓	✓	—	3VA9277-0FK47	
		—	—	—	✓	3VA9447-0FK47	

## Supplementary Handle for Door Mounted Rotary Operator (NFPA-79 compliant)

	Type	Color	3VA5	3VA5	3VA6	3VA6	Catalog Number
			125A	250A	150A 250A	400A 600A	
	Standard	Gray	✓	—	—	—	3VA9057-0GC01
			—	✓	✓	—	3VA9277-0GC01
			—	—	—	✓	3VA9447-0GC11
	EMERGENCY-OFF	Yellow-Red	✓	—	—	—	3VA9057-0GC05
			—	✓	✓	—	3VA9277-0GC05
			—	—	—	✓	3VA9447-0GC15



① Lockable with up to three padlock hasps.

# 3VA Molded Case Circuit Breakers

3VA Manual Operators

Selection

## Side Mounted Rotary Operator<sup>①</sup>

	Type	Color	3VA5 125A	3VA5 250A	3VA6 150A 250A	3VA6 400A 600A	Catalog Number
 <ul style="list-style-type: none"> <li>Without mounting plate</li> <li>Rotary operator with shaft 300 mm</li> <li>Handle with masking plate 75 x 75 mm</li> <li>Degree of protection NEMA 1, 12, 3R</li> </ul>	Standard	Gray	✓	—	—	—	3VA9137-0PK11
			—	✓	✓	—	3VA9277-0PK11
			—	—	—	—	
	Standard with illumination kit	Gray	✓	—	—	—	3VA9137-0PK13
			—	✓	✓	—	3VA9277-0PK13
			—	—	—	—	
	EMERGENCY-OFF	Yellow-Red	✓	—	—	—	3VA9137-0PK15
			—	✓	✓	—	3VA9277-0PK15
—			—	—	—		
EMERGENCY-OFF with illumination kit	Yellow-Red	✓	—	—	—	3VA9137-0PK17	
		—	✓	✓	—	3VA9277-0PK17	
		—	—	—	—		
 <ul style="list-style-type: none"> <li>With mounting plate</li> <li>Rotary operator with short shaft</li> <li>Handle with masking plate 75 x 75 mm</li> </ul>	Standard NEMA 1, 3R, 12, with mounting plate	Gray	✓	—	—	—	3VA9137-0PK51
			—	✓	✓	—	3VA9277-0PK51
			—	—	—	—	
	Standard NEMA 1, 3R, 12, with mounting plate, with illumination kit	Gray	✓	—	—	—	3VA9137-0PK53
			—	✓	✓	—	3VA9277-0PK53
			—	—	—	—	
	EMERGENCY-OFF NEMA 1, 3R, 12, with mounting plate	Yellow-Red	✓	—	—	—	3VA9137-0PK55
			—	✓	✓	—	3VA9277-0PK55
—			—	—	—		
EMERGENCY-OFF NEMA 1, 3R, 12, with mounting plate, with illumination kit	Yellow-Red	✓	—	—	—	3VA9137-0PK57	
		—	✓	✓	—	3VA9277-0PK57	
		—	—	—	—		

## Door Interlock Side Mounted Rotary Operator<sup>①</sup>

	Type	Color	3VA5 125A	3VA5 250A	3VA6 150A 250A	3VA6 400A 600A	Catalog Number
 <ul style="list-style-type: none"> <li>Standard for use with the side wall mounted rotary operators</li> <li>Without mounting plate</li> </ul>		Gray	✓	—	—	—	3VA9177-0VF40
			—	✓	✓	—	3VA9277-0VF40
			—	—	—	—	

## Motor Operator without Stored Energy Feature<sup>①</sup>

	Type	3VA5 125 A	3VA5 250 A	3VA6 150 A 250 A	3VA6 400 A 600 A	Part Number
	24 ... 60 V DC	✓	—	—	—	3VA9137-0HA10
		—	✓	✓	—	3VA9277-0HA10
		—	—	—	✓	3VA9447-0HA10
	110 ... 230 V AC 110 ... 250 V DC	✓	—	—	—	3VA9137-0HA20
		—	✓	✓	—	3VA9277-0HA20
		—	—	—	✓	3VA9447-0HA20

<sup>①</sup> Lockable with up to three padlock hasps.

# 3VA Molded Case Circuit Breakers







3VA Manual Operators

Selection

## Handles with Masking Plate

	Type	Color	Tolerance Compensation	Door Open Function	3VA5	3VA5	3VA6	3VA6	Catalog Number		
					125A	250A	150A 250A	400A 600A			
	Standard	Gray	Without	Without	✓	✓	✓	—	8UD1721-0AB11		
			With	Without	✓	✓	✓	—	8UD1721-0AB21		
			Without	Without	—	—	—	✓	8UD1731-0AB11		
			With	Without	—	—	—	✓	8UD1731-0AB21		
			Without	With	✓	✓	✓	—	8UD1721-0AC11		
			With	With	✓	✓	✓	—	8UD1721-0AC21		
			Without	With	—	—	—	✓	8UD1731-0AC11		
			With	With	—	—	—	✓	8UD1731-0AC21		
			EMERGENCY-OFF	Yellow-Red	Without	Without	✓	✓	✓	—	8UD1721-0AB15
					With	Without	✓	✓	✓	—	8UD1721-0AB25
					Without	Without	—	—	—	✓	8UD1731-0AB15
					With	Without	—	—	—	✓	8UD1731-0AB25
			Without	With	✓	✓	✓	—	8UD1721-0AC15		
			With	With	✓	✓	✓	—	8UD1721-0AC25		
	Without	With	—	—	—	✓	8UD1731-0AC15				
	With	With	—	—	—	✓	8UD1731-0AC25				

## Door Mounted Rotary Operator Accessories









	Type	3VA5 125A	3VA5 250A	3VA6 150A 250A	3VA6 400A 600A	Catalog Number
	8 mm Shaft 300 mm long	✓	✓	✓	✓	8UD1900-2WA00
	8 mm Shaft 600 mm long	✓	✓	✓	✓	8UD1900-2WB00
	Adapter for Shaft for door mounted operator	✓	✓	✓	✓	8UD1900-2DA00
	Door Coupling 8 mm x 8 mm	✓	✓	✓	✓	8UD1900-2HA00
	Fixing bracket for Shaft	✓	—	—	—	3VA9137-0GA80
		—	✓	✓	✓	3VA9477-0GA80
	Variable depth adapter 8 x 8 mm	✓	✓	✓	✓	3VA9487-0GB10
	Mounting tolerance compensation 8 x 8 mm	✓	✓	✓	✓	8UD1900-2GA00

# 3VA Molded Case Circuit Breakers

3VA Manual Operators

Selection

## General Accessories for Manual Operators

	Type	Details	Part Number
	Labeling plate for manual operators	—	3VA9087-0SX10
	Illumination kit for manual operators 24 V DC voltage	<b>For Molded Case Circuit Breakers</b> 3VA5, 125...250 A 3VA6, 150...600 A 3VA5, 3VA6, 125...600 A	Front mounted rotary operators Front mounted rotary operators Door mounted rotary operators 8UD1900-0KA10 8UD1900-0KA20 8UD1900-0KA20
	Cylinder Lock (type Kaba) <ul style="list-style-type: none"> <li>For door mounted rotary operator (in masking plate)</li> <li>Standard masking plate</li> </ul>	Key 1 Key 2 Key 3 Key 4	8UD1900-0MB01 8UD1900-0NB01 8UD1900-0PB01 8UD1900-0QB01
	Cylinder Lock (type Kaba) <sup>Ⓞ</sup> <ul style="list-style-type: none"> <li>For door mounted rotary operator (in masking plate)</li> <li>Standard masking plate</li> </ul>	Key 1 Key 2 Key 3 Key 4	8UD1900-0MC01 8UD1900-0NC01 8UD1900-0PC01 8UD1900-0QC01
	Cylinder Lock (type Kaba) <ul style="list-style-type: none"> <li>For door mounted rotary operator (in masking plate)</li> <li>EMERGENCY-OFF masking plate</li> </ul>	Key 1 Key 2 Key 3 Key 4	8UD1900-0MB05 8UD1900-0NB05 8UD1900-0PB05 8UD1900-0QB05
	Cylinder Lock (type Kaba) <sup>Ⓞ</sup> <ul style="list-style-type: none"> <li>For door mounted rotary operator (in masking plate)</li> <li>EMERGENCY-OFF masking plate</li> </ul>	Key 1 Key 2 Key 3 Key 4	8UD1900-0MC05 8UD1900-0NC05 8UD1900-0PC05 8UD1900-0QC05
	Cylinder Lock (type Ronis) <ul style="list-style-type: none"> <li>includes 2 keys</li> <li>for locking or interlocking</li> <li>installation in all rotary operators w/ shaft stub</li> </ul>	Key 1 Key 2 Key 3 Key 4	3VA9980-0VL10 3VA9980-0VL20 3VA9980-0VL30 3VA9980-0VL40
	Cylinder lock adapter for rotary operator <ul style="list-style-type: none"> <li>to mount in rotary operator</li> </ul>		3VA9980-0LF20





Ⓞ With door open function

# 3VA Molded Case Circuit Breakers

3VA Manual Operators

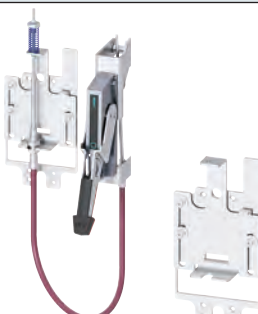
Selection

## Max Flex Operator

	Type	3VA5 125A	3VA5 250A	3VA6 150A 250A	3VA6 400A 600A	Catalog Number
 <p><b>Complete kit and spare mechanism</b></p>	Complete Kit <ul style="list-style-type: none"> <li>Switching mechanism</li> <li>Plastic handle, NEMA 1/12, black=OFF, red=ON</li> <li>Bowden Cable 36 inches (0.9m) long</li> </ul>	✓	—	—	—	3VA9137-0CK12
		—	✓	✓	—	3VA9277-0CK12
		—	—	—	✓	3VA9477-0CK12
	Complete Kit <ul style="list-style-type: none"> <li>Switching mechanism</li> <li>Steel handle, epoxy coated NEMA 1/3R/12, black=OFF, red=ON,</li> <li>Bowden Cable 36 inches (0.9m) long</li> </ul>	✓	—	—	—	3VA9137-0CK72
		—	✓	✓	—	3VA9277-0CK72
		—	—	—	✓	3VA9477-0CK72
	Operating Mechanism (spare)	✓	—	—	—	3VA9137-0CB10
		—	✓	✓	—	3VA9277-0CB10
		—	—	—	✓	3VA9477-0CB10
	Handle - Plastic, NEMA 1/12, black = OFF, red = ON	✓	✓	✓	✓	3VA9977-0CH12
	Handle - Steel, Epoxy coated, NEMA 1/3R/12, black = OFF, red = ON	✓	✓	✓	✓	3VA9977-0CH72
	Handle - Steel, Epoxy coated, NEMA 1/3R/12, black = OFF, black = ON	✓	✓	✓	✓	3VA9977-0CH74
	Handle - Steel, chrome-plated, NEMA 4/4X, black = OFF, red = ON	✓	✓	✓	✓	3VA9977-0CH82
	Handle - Steel, chrome-plated, NEMA 4/4X, black = OFF, black = ON	✓	✓	✓	✓	3VA9977-0CH84
	Bowden Cable, 36 inches (0.9m)	✓	✓	✓	—	3VA9278-0CC10
	Bowden Cable, 48 inches (1.2m)	✓	✓	✓	—	3VA9278-0CC20
	Bowden Cable, 60 inches (1.5m)	✓	✓	✓	—	3VA9278-0CC30
	Bowden Cable, 72 inches (1.8m)	✓	✓	✓	—	3VA9278-0CC40
	Bowden Cable, 84 inches (2.1m)	✓	✓	✓	—	3VA9278-0CC50
	Bowden Cable, 96 inches (2.4m)	✓	✓	✓	—	3VA9278-0CC60
	Bowden Cable, 120 inches (3.0m)	✓	✓	✓	—	3VA9278-0CC70
	Bowden Cable, 144 inches (3.6m)	✓	✓	✓	—	3VA9278-0CC80
	Bowden Cable, 36 inches (0.9m)	—	—	—	✓	3VA9578-0CC10
	Bowden Cable, 48 inches (1.2m)	—	—	—	✓	3VA9578-0CC20
	Bowden Cable, 60 inches (1.5m)	—	—	—	✓	3VA9578-0CC30
	Bowden Cable, 72 inches (1.8m)	—	—	—	✓	3VA9578-0CC40
	Bowden Cable, 84 inches (2.1m)	—	—	—	✓	3VA9578-0CC50
	Bowden Cable, 96 inches (2.4m)	—	—	—	✓	3VA9578-0CC60
Bowden Cable, 120 inches (3.0m)	—	—	—	✓	3VA9578-0CC70	
Bowden Cable, 144 inches (3.6m)	—	—	—	✓	3VA9578-0CC80	
	MaxFlex Auxiliary switch (leading from On to Off) <ul style="list-style-type: none"> <li>1 CO</li> </ul>	✓	✓	✓	✓	3VA9478-0CX10
	MaxFlex Auxiliary switch (leading from On to Off) <ul style="list-style-type: none"> <li>2 CO</li> </ul>	✓	✓	✓	✓	3VA9478-0CX20

## Variable depth flange mounted operator kit



	Type	3VA5 125A	3VA5 250A	3VA6 150A 250A	3VA6 400A 600A	Catalog Number
	Complete kit comprising: <ul style="list-style-type: none"> <li>Switching mechanism adjustable depth 200mm to 400mm</li> <li>Epoxy coated steel handle, NEMA 1/3R/12, black = OFF, red = ON</li> </ul>	✓	—	—	—	3VA9138-0DK72
		—	✓	✓	—	3VA9278-0DK72
		—	—	—	✓	3VA9478-0DK72
	Complete kit comprising: <ul style="list-style-type: none"> <li>Switching mechanism adjustable depth 200mm to 400mm</li> <li>Stainless steel handle, chrome-plated NEMA 4/4X, black=OFF, red=ON</li> </ul>	✓	—	—	—	3VA9138-0DK82
		—	✓	✓	—	3VA9278-0DK82
		—	—	—	✓	3VA9478-0DK82
	Complete kit comprising: <ul style="list-style-type: none"> <li>Switching mechanism adjustable depth 200mm to 400mm</li> <li>Handle stainless steel, chrome-plated NEMA 4/4X, black=OFF, black=ON</li> </ul>	✓	—	—	—	3VA9138-0DK84
		—	✓	✓	—	3VA9278-0DK84
		—	—	—	✓	3VA9478-0DK84

# 3VA Molded Case Circuit Breakers





## 3VA Connection Technology

## Selection

### Box Terminals

	Type	Minimum cable cross-section (standard) Class B	Maximum cable cross-section (standard) Class B	For molded case circuit breakers/ rated current				Part Number
				3VA5 125 A	3VA5 250 A	3VA6 150 A 250 A	3VA6 400 A 600 A	
	Steel wrap-around lug (Cu cable only) kit of 3 single lugs	AWG 14	3/0	✓	—	—	—	3VA9133-0JA11
		AWG 10	3/0	—	✓	—	—	3VA9233-0JA11
		AWG 4	350 kcmil	—	✓	—	—	3VA9233-0JA12
		AWG 10	3/0	—	—	✓	—	3VA9143-0JA12
		AWG 4	350 kcmil	—	—	✓	—	3VA9243-0JA12
	Steel wrap-around lug (Cu cable only) kit of 4 single lugs	1/0	500 kcmil	—	—	—	✓	3VA9474-0JA13
		AWG 10	3/0	—	—	✓	—	3VA9144-0JA12
		AWG 4	350 kcmil	—	—	✓	—	3VA9244-0JA12
		1/0	500 kcmil	—	—	—	✓	3VA9474-0JA13

### Aluminum Wire Connectors

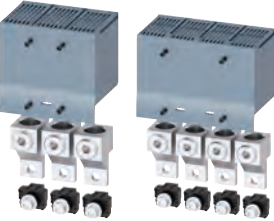
	Type	Minimum cable cross-section (standard) Class B	Maximum cable cross-section (standard) Class B	For molded case circuit breakers/ rated current				Part Number
				3VA5 125 A	3VA5 250 A	3VA6 150 A 250 A	3VA6 400 A 600 A	
	Aluminum body lug (Cu/Al cable) kit of 3 single lugs	AWG 14	3/0	✓	—	—	—	3VA9133-0JB11
		AWG 6	350 kcmil	—	✓	—	—	3VA9233-0JB12
		AWG 14	1/0	—	—	✓	—	3VA9143-0JB11
		AWG 6	350 kcmil	—	—	✓	—	3VA9243-0JB12
		AWG 1	600 kcmil	—	—	—	✓	3VA9373-0JB13
	Aluminum body lug (Cu/Al cable) kit of 4 single lugs	AWG 14	1/0	—	—	✓	—	3VA9144-0JB11
		AWG 6	350 kcmil	—	—	✓	—	3VA9244-0JB12
		AWG 1	600 kcmil	—	—	—	✓	3VA9374-0JB13
	Aluminum body lug with control wire tap (Cu/Al cable) kit of 3 single lugs	AWG 14	3/0	✓	—	—	—	3VA9133-0JG11
		AWG 6	350 kcmil	—	✓	—	—	3VA9233-0JG12
		AWG 14	1/0	—	—	✓	—	3VA9143-0JG11
		AWG 6	350 kcmil	—	—	✓	—	3VA9243-0JG12
		AWG 1	600 kcmil	—	—	—	✓	3VA9373-0JG13
	Aluminum body lug with control wire tap (Cu/Al cable) kit of 4 single lugs	AWG 14	1/0	—	—	✓	—	3VA9144-0JG11
		AWG 6	350 kcmil	—	—	✓	—	3VA9244-0JG12
		AWG 1	600 kcmil	—	—	—	✓	3VA9374-0JG13
	Aluminum body lug large (Cu/Al cable) kit of 3 single lugs and 1 extended terminal cover	AWG 4	350 kcmil	✓	—	—	—	3VA9133-0JJ12
		AWG 2	350 kcmil	—	✓	—	—	3VA9233-0JJ13
		AWG 2	350 kcmil	—	—	—	✓	3VA9243-0JJ13
		AWG 2	350 kcmil	—	—	✓	—	3VA9244-0JJ13







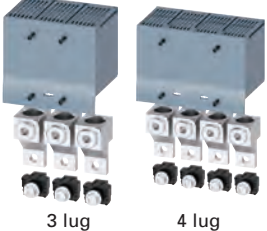
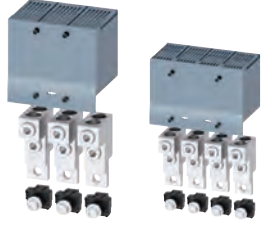

# 3VA Molded Case Circuit Breakers

## 3VA Connection Technology

## Selection

### Aluminum Wire Connectors (cont.)







	Type	Minimum cable cross-section (standard) Class B	Maximum cable cross-section (standard) Class B	For molded case circuit breakers/ rated current				Part Number	
				3VA5 125 A	3VA5 250 A	3VA6 150 A 250 A	3VA6 400 A 600 A		
 <p>3 lug      4 lug</p>	Aluminum body lug large with control wire tap (Cu/Al cable) kit of 3 single lugs and 1 extended terminal cover	AWG 4	350 kcmil	✓	—	—	—	3VA9133-0JC12	
		AWG 2	350 kcmil	—	✓	—	—	3VA9233-0JC13	
		AWG 2	350 kcmil	-	-	✓	-	3VA9243-0JC13	
 <p>3 lug      4 lug</p>	Aluminum body lug large with control wire tap (Cu/Al cable) kit of 4 single lugs and 1 extended terminal cover	AWG 2	350 kcmil	—	—	✓	—	3VA9244-0JC13	
 <p>3 lug      4 lug</p>	Aluminum body lug, 2 Cables (Cu/Al cable) kit of 3 single lugs and 1 extended terminal cover	AWG 4	300 kcmil	—	✓	—	—	3VA9233-0JJ22	
		AWG 4	300 kcmil	—	—	✓	—	3VA9243-0JJ22	
		2/0	600 kcmil	-	-	-	✓	3VA9473-0JJ23	
	 <p>3 lug      4 lug</p>	Aluminum body lug, 2 Cables (Cu/Al cable) kit of 4 single lugs and 1 extended terminal cover	AWG 4	300 kcmil	—	—	✓	—	3VA9244-0JJ22
2/0			600 kcmil	-	-	-	✓	3VA9474-0JJ23	
 <p>3 lug      4 lug</p>	Aluminum body lug, 2 Cables with control wire tap (Cu/Al cable) kit of 3 single lugs and 1 extended terminal cover	AWG 4	300 kcmil	—	✓	—	—	3VA9233-0JC22	
		AWG 4	300 kcmil	—	—	✓	—	3VA9243-0JC22	
		2/0	600 kcmil	-	-	-	✓	3VA9473-0JC23	
	 <p>3 lug      4 lug</p>	Aluminum body lug, 2 Cables with control wire tap (Cu/Al cable) kit of 4 single lugs and 1 extended terminal cover	AWG 4	300 kcmil	—	—	✓	—	3VA9244-0JC22
2/0			600 kcmil	—	—	—	✓	3VA9474-0JC23	
 <p>3 lug      4 lug</p>	Distribution lug, 6 Cables (Cu/Al cable) kit of 3 single lugs and 1 extended terminal cover	AWG 14	AWG 2	✓	—	—	—	3VA9133-0JF60	
			AWG 2	—	✓	—	—	—	3VA9233-0JF60
			AWG 2	—	—	✓	—	—	3VA9243-0JF60
			AWG 2	—	—	—	✓	—	3VA9373-0JF60
	<p>3 lug      4 lug</p>	Distribution lug, 6 Cables (Cu/Al cable) kit of 4 single lugs and 1 extended terminal cover	AWG 14	AWG 2	—	—	✓	—	3VA9244-0JF60
				AWG 2	—	—	—	✓	—

# 3VA Molded Case Circuit Breakers

## 3VA Connection Technology

## Selection

### Copper Wire Connectors



	Type	Minimum cable cross-section (standard) Class B	Maximum cable cross-section (standard) Class B	For molded case circuit breakers/ rated current				Part Number
				3VA5 125 A	3VA5 250 A	3VA6 150 A 250 A	3VA6 400 A 600 A	
	Copper body lug (Cu cable only) kit of 3 single lugs	AWG 14	2/0	✓	—	—	—	3VA9133-0JD11
		AWG 6	350 kcmil	—	✓	—	—	3VA9233-0JD12
		AWG 14	1/0	—	—	✓	—	3VA9143-0JD11
		AWG 6	350 kcmil	—	—	✓	—	3VA9243-0JD12
	Copper body lug (Cu cable only) kit of 4 single lugs	AWG 14	1/0	—	—	✓	—	3VA9144-0JD11
		AWG 6	350 kcmil	—	—	✓	—	3VA9244-0JD12
		AWG 1	600 kcmil	—	—	—	✓	3VA9374-0JD13
	Copper body lug with control wire tap (Cu cable only) kit of 3 single lugs	AWG 14	2/0	✓	—	—	—	3VA9133-0JK11
		AWG 6	350 kcmil	—	✓	—	—	3VA9233-0JK12
		AWG 14	1/0	—	—	✓	—	3VA9143-0JK11
		AWG 6	350 kcmil	—	—	✓	—	3VA9243-0JK12
	Copper body lug with control wire tap (Cu cable only) kit of 4 single lugs	AWG 14	1/0	—	—	✓	—	3VA9144-0JK11
		AWG 6	350 kcmil	—	—	✓	—	3VA9244-0JK12
		AWG 1	600 kcmil	—	—	—	✓	3VA9374-0JK13
	Copper body lug 2 Cables (Cu cable only) kit of 3 single lugs and 1 extended terminal cover	2/0	600 kcmil	—	—	—	✓	3VA9473-0JE23
	Copper body lug 2 Cables (Cu cable only) kit of 4 single lugs and 1 extended terminal cover	2/0	600 kcmil	—	—	—	✓	3VA9474-0JE23
	Copper body lug 2 Cables with control wire tap (Cu cable only) kit of 3 single lugs and 1 extended terminal cover	2/0	600 kcmil	—	—	—	✓	3VA9473-0JL23
	Copper body lug 2 Cables with control wire tap (Cu cable only) kit of 4 single lugs and 1 extended terminal cover	2/0	600 kcmil	—	—	—	✓	3VA9474-0JL23

# 3VA Molded Case Circuit Breakers







## 3VA Connection Technology

## Selection

### Nut Keeper Kits

	Type	Maximum terminal width	Maximum terminal thickness	For molded case circuit breakers/ rated current				Part Number
				3VA5 125 A	3VA5 250 A	3VA6 150 A 250 A	3VA6 400 A 600 A	
	Nut keeper kit kit of 3 single lugs	6.5 mm / 0.25 inch	17 mm / 0.7 inch	✓	—	—	—	3VA9133-0QA00
		8 mm / 0.3 inch	25 mm / 1 inch	—	✓	—	—	3VA9233-0QA00
		8 mm / 0.3 inch	25 mm / 1 inch	—	—	✓	—	3VA9243-0QA00
		10 mm / 0.4 inch	35 mm / 1.4 inch	—	—	—	✓	3VA9473-0QA00
	Nut keeper kit kit of 4 single lugs	8 mm / 0.3 inch	25 mm / 1 inch	—	—	✓	—	3VA9244-0QA00
		10 mm / 0.4 inch	35 mm / 1.4 inch	—	—	—	✓	3VA9474-0QA00

### Bus Connector Extensions





	Type	Maximum terminal width	Maximum terminal thickness	For molded case circuit breakers/ rated current				Part Number
				3VA5 125 A	3VA5 250 A	3VA6 150 A 250 A	3VA6 400 A 600 A	
	Front bus connectors extended 1 single connector	22 mm / 0.9 inch	8 mm / 0.3 inch	✓	—	—	—	3VA9131-0QB00
	Front bus connectors extended kit of 3 single connectors, 2 phase barriers, and 1 insulating plate	22 mm / 0.9 inch	8 mm / 0.3 inch	✓	—	—	—	3VA9133-0QB00
	Front bus connectors extended kit of 3 single connectors and 1 insulating plate	32 mm / 1.3 inch	10 mm / 0.4 inch	—	✓	✓	—	3VA9273-0QB00
		40 mm / 1.6 inch	12.5 mm / 0.5 inch	—	—	—	✓	3VA9473-0QB00
	Front bus connectors extended kit of 4 single connectors and 1 insulating plate	32 mm / 1.3 inch	10 mm / 0.4 inch	—	—	✓	—	3VA9274-0QB00
		40 mm / 1.6 inch	12.5 mm / 0.5 inch	—	—	—	✓	3VA9474-0QB00
	Front bus connectors offset kit of 3 single connectors 1 insulating plate Distance between pole centers: 400/600 A = 70 mm / 2.76 inches	60 mm / 2.4 inch	12.5 mm / 0.5 inch	—	—	—	✓	3VA9473-0QC00
	Front bus connectors offset kit of 4 single connectors 1 insulating plate Distance between pole centers: 400/600 A = 70 mm / 2.76 inches	60 mm / 2.4 inch	12.5 mm / 0.5 inch	—	—	—	✓	3VA9474-0QC00

# 3VA Molded Case Circuit Breakers





## 3VA Connection Technology

## Selection

### Rear connection studs flat

	Type	For molded case circuit breakers / rated current				Part Number
		3VA5 125 A	3VA5 250 A	3VA6 150 A 250 A	3VA6 400 A 600 A	
	Rear connection studs flat kit of 2 short flat studs and 1 long flat stud	✓	—	—	—	3VA9133-0QE00
		—	✓	—	—	3VA9233-0QE00
		—	—	✓	—	3VA9243-0QE00
		—	—	—	✓	3VA9473-0QE00
	Rear connection studs flat kit of 2 short flat studs and 2 long flat studs	—	—	✓	—	3VA9244-0QE00
		—	—	—	✓	3VA9474-0QE00
	Rear connection studs flat 1 short flat stud	✓	—	—	—	3VA9131-0QE10
		—	✓	—	—	3VA9231-0QE10
		—	—	✓	—	3VA9241-0QE10
		—	—	—	✓	3VA9471-0QE10
	Rear connection studs flat 1 long flat stud	✓	—	—	—	3VA9131-0QE20
		—	✓	—	—	3VA9231-0QE20
		—	—	✓	—	3VA9241-0QE20
		—	—	—	✓	3VA9471-0QE20

### Rear connection studs round







	Rear connection studs round kit of 1 long round stud and 2 short round studs	✓	—	—	—	3VA9133-0QF00
		—	✓	—	—	3VA9233-0QF00
		—	—	✓	—	3VA9243-0QF00
		—	—	—	✓	3VA9473-0QF00
	Rear connection studs round kit of 2 long round studs and 2 short round studs	—	—	✓	—	3VA9244-0QF00
		—	—	—	✓	3VA9474-0QF00
	Rear connection studs round 1 short round studs	✓	—	—	—	3VA9131-0QF10
		—	✓	—	—	3VA9231-0QF10
		—	—	✓	—	3VA9241-0QF10
		—	—	—	✓	3VA9471-0QF10
	Rear connection studs round 1 long round stud	✓	—	—	—	3VA9131-0QF20
		—	✓	—	—	3VA9231-0QF20
		—	—	✓	—	3VA9241-0QF20
		—	—	—	✓	3VA9471-0QF20

# 3VA Molded Case Circuit Breakers

3VA Connection Technology

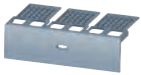
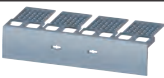
Selection

## Phase barriers, terminal covers, and insulating plates





	Type	For molded case circuit breakers / rated current				Part Number
		3VA5 125 A	3VA5 250 A	3VA6 150 A 250 A	3VA6 400 A 600 A	
	Phase barriers kit of 2 phase barriers	✓	—	—	—	3VA9132-0WA00
		—	✓	✓	—	3VA9272-0WA00
		—	—	—	✓	3VA9472-0WA00
	Terminal cover for 1-pole breakers	✓	—	—	—	3VA9131-0WD10
	Terminal cover for 3-pole breakers	✓	—	—	—	3VA9131-0WD30
		—	✓	✓	—	3VA9271-0WD30
		—	—	—	✓	3VA9471-0WD30
	Terminal cover for 4-pole breakers	—	—	✓	—	3VA9271-0WD40
		—	—	—	✓	3VA9471-0WD40
	Terminal cover extended for 3-pole breakers	✓	—	—	—	3VA9131-0WF30
		—	✓	✓	—	3VA9271-0WF30
		—	—	—	✓	3VA9471-0WF30
	Terminal cover extended for 4-pole breakers	—	—	✓	—	3VA9271-0WF40
		—	—	—	✓	3VA9471-0WF40
	Terminal cover offset for 3-pole breakers	—	—	—	✓	3VA9471-0WG30
	Terminal cover offset for 4-pole breakers	—	—	—	✓	3VA9471-0WG40

# 3VA Molded Case Circuit Breakers

3VA Connection Technology

Selection

Phase barriers, terminal covers, and insulating plates



	Type	For molded case circuit breakers / rated current				Part Number
		3VA5 125 A	3VA5 250 A	3VA6 150 A 250 A	3VA6 400 A 600 A	
	Rear insulating plate extended for 3-pole breakers	✓	—	—	—	3VA9131-0WJ30
		—	✓	✓	—	3VA9271-0WJ30
		—	—	—	✓	3VA9471-0WJ30
	Rear insulating plate extended for 4-pole breakers	—	—	✓	—	3VA9271-0WJ40
		—	—	—	✓	3VA9471-0WJ40
	Rear insulating plate offset for 3-pole breakers	—	—	—	✓	3VA9471-0WK30
		—	—	—	—	—
	Rear insulating plate offset for 4-pole breakers	—	—	—	✓	3VA9471-0WK40
		—	—	—	—	—
	Control wire tap for busbar (for fixed mounting)	—	✓	✓	—	3VA9271-0WC00
		—	—	—	✓	3VA9471-0WC00

# 3VA Molded Case Circuit Breakers

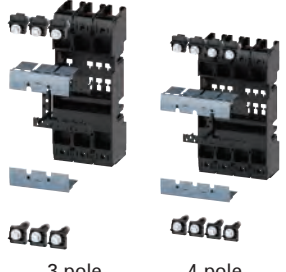

## 3VA Plug-in and Draw-out Technology

Selection

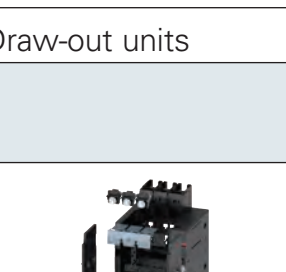
### Plug-in socket

	Type	For molded case circuit breakers / rated current			Part Number
		3VA61/62 150A/250A	3VA63 400A	3VA64 600A	
 <p>3 pole      4 pole</p>	Plug-in unit, 3-pole, complete kit Consists of: Plug-in socket, Plug-in unit, conversion kit, Mounting screw kit	✓	—	—	3VA9143-0KP00
		—	✓	—	3VA9343-0KP00
		—	—	✓	3VA9443-0KP00
 <p>3 pole      4 pole</p>	Plug-in unit, 4-pole, complete kit Consists of: Plug-in socket, Plug-in unit, conversion kit, Mounting screw kit	✓	—	—	3VA9144-0KP00
		—	✓	—	3VA9344-0KP00
		—	—	✓	3VA9444-0KP00
 <p>3 pole      4 pole</p>	Plug-in unit, 3-pole, conversion kit Consists of: Screw-fastened terminal covers for molded case circuit breakers, Plug-in contacts, Cable cage, Autotrip plunger	✓	—	—	3VA9143-0KP10
		—	✓	✓	3VA9343-0KP10
	Plug-in unit, 4-pole, conversion kit Consists of: Screw-fastened terminal covers for molded case circuit breakers, Plug-in contacts, Cable cage, Autotrip plunger	✓	—	—	3VA9144-0KP10
		—	✓	✓	3VA9344-0KP10

### Draw-out units

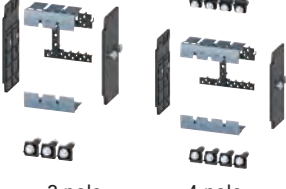
	Type	For molded case circuit breakers / rated current			Part Number
		3VA61/62 150A/250A	3VA63 400A	3VA64 600A	
 <p>3 pole</p>	Draw-out unit, 3-pole, complete kit Consists of: Draw-out socket, Draw-out unit, conversion kit, Mounting screw kit	✓	—	—	3VA9143-0KD00
		—	✓	—	3VA9343-0KD00
		—	—	✓	3VA9443-0KD00
 <p>4 pole</p>	Draw-out unit, 4-pole, complete kit Consists of: Draw-out socket, Draw-out unit, conversion kit, Mounting screw kit	✓	—	—	3VA9144-0KD00
		—	✓	—	3VA9344-0KD00
		—	—	✓	3VA9444-0KD00
 <p>3 pole      4 pole</p>	Draw-out unit, 3-pole, conversion kit Consists of: Screw-fastened terminal covers, Side wall, Plug-in contacts, Cable cage, Autotrip plunger	✓	—	—	3VA9143-0KD10
		—	✓	✓	3VA9343-0KD10
	Draw-out unit, 4-pole, conversion kit Consists of: Screw-fastened terminal covers, Side wall, Plug-in contacts, Cable cage, Autotrip plunger	✓	—	—	3VA9144-0KD10
		—	✓	✓	3VA9344-0KD10







Note: Crank handle for the drawout unit must be ordered separately.

# 3VA Molded Case Circuit Breakers

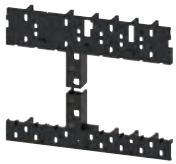
3VA Plug-in and Draw-out Technology

Selection

## Accessories

	Type	For molded case circuit breakers / rated current		Part Number
		3VA61/62 150A/250A	3VA63/64 400A/600A	
	Cable cage for plug-in/draw-out unit 3-/4-pole (spare part) Cable duct for routing of the required cables from the internal acc. on the back of the breaker.	✓	—	3VA9167-0KB02
		—	✓	3VA9367-0KB02
	Door feedthrough	✓	—	3VA9147-0KT00
		—	✓	3VA9347-0KT00
	Autotrip plunger Plug-in unit	✓	—	3VA9267-0KP81
		—	✓	3VA9457-0KP81
	Autotrip plunger Draw-out unit	✓	—	3VA9267-0KD81
		—	✓	3VA9457-0KD81
	Terminal cover for plug-in/draw-out unit, 3-pole (spare part) To provide circuit breaker touch protection, for mounting on the molded case circuit breaker	✓	—	3VA9143-0KB01
		—	✓	3VA9343-0KB01
	Terminal cover for plug-in/draw-out unit, 4-pole (spare part) To provide circuit breaker touch protection, for mounting on the molded case circuit breaker	✓	—	3VA9144-0KB01
		—	✓	3VA9344-0KB01
	Crank handle for draw-out unit Insulated, including crank holder			3VA9987-0KD81



# 3VA Molded Case Circuit Breakers

3VA Plug-in and Draw-out Technology

Selection

## Other Accessories

	Type	Part Number
	Communication link for draw-out unit Consists of: Cable kit with 3 special position signaling switches, connecting cable 3VA9987-0KC10	3VA9977-0KC00
	Position signaling switches For draw-out unit	3VA9977-0KB00
	Spare connecting cable To connect the position signaling switches for communication with the COM060	3VA9987-0KC10
	Auxiliary circuit connector ■ For draw-out units	3VA9977-0KD80
	Auxiliary circuit connector ■ For plug-in units	3VA9977-0KP80
	Cylinder lock (type Ronis) ■ Includes a lock with 2 keys ■ For locking ■ For installation in all rotary operators with shaft stub ■ For mounting in the adapter kit for the accessories component	3VA9980-0VL10
		3VA9980-0VL20
		3VA9980-0VL30
		3VA9980-0VL40
	Cylinder lock adapter for draw-out unit ■ For fitting a cylinder lock in the right-hand side wall of the draw-out unit ■ To prevent unauthorized withdrawal or insertion of the circuit breaker; ■ Circuit breaker can be locked in the CONNECT, TEST, or DISCONNECT position	3VA9970-0LF40

# 3VA Molded Case Circuit Breakers

## Communications overview

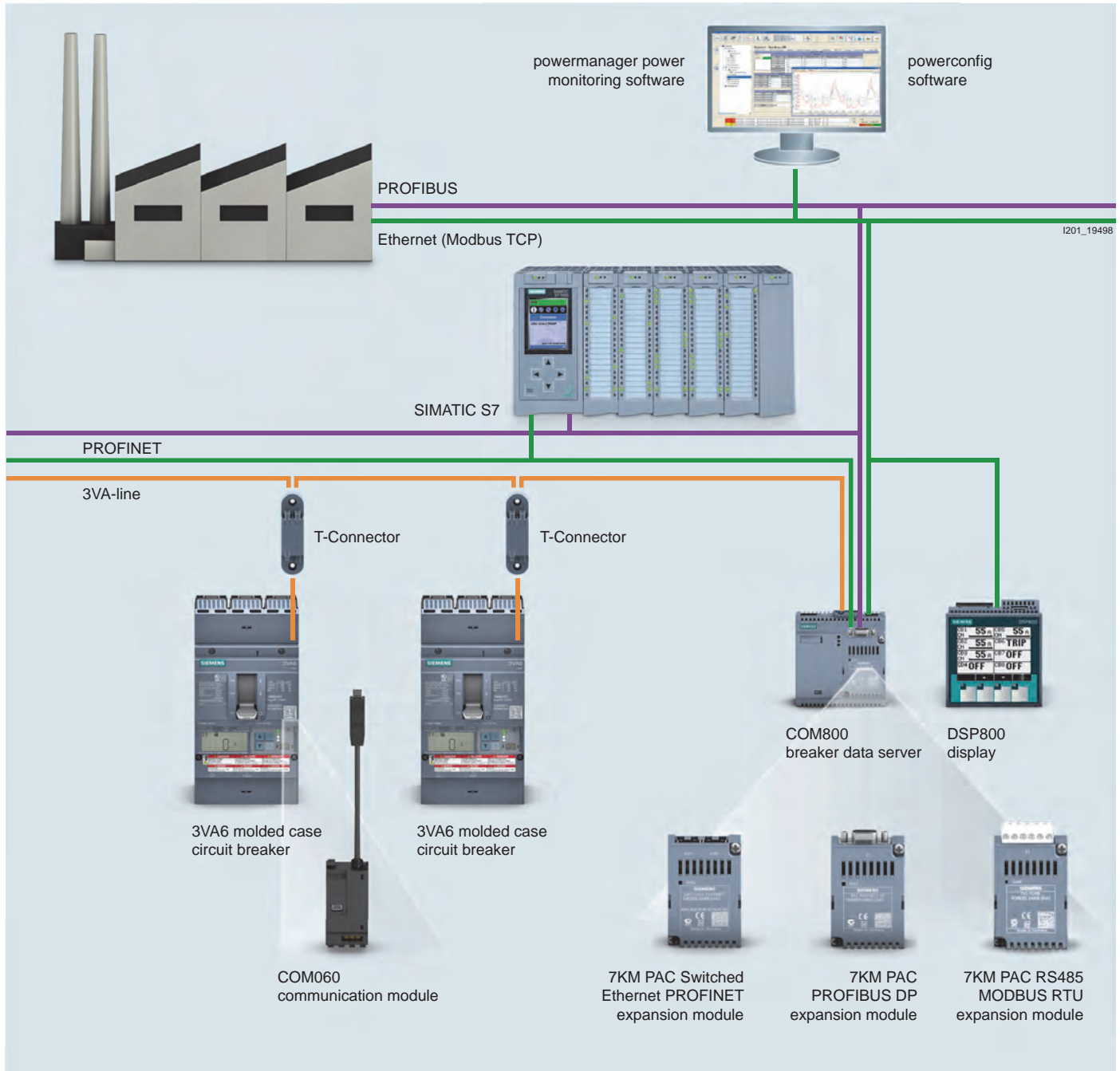



# 3VA Molded Case Circuit Breakers





3VA Communication and Testing/Commissioning Devices

Selection

## Modules

	Type	For molded case circuit breakers / rated current		Part Number
		3VA61/62 150A/250 A	3VA63/64 400A/600A	
	24 V Module <ul style="list-style-type: none"> <li>24 V DC</li> <li>For mounting in the right-hand accessories compartment of the 3VA6</li> <li>Optional energy supply for the ETU, also includes continuous operation of the ETU display and the metering function of the ETU 8-series</li> </ul>	✓	—	3VA9177-0TB50
		—	✓	3VA9377-0TB50
	COM060 communication module <ul style="list-style-type: none"> <li>For mounting in the right-hand accessories compartment of the 3VA6 molded case circuit breaker (including ETU power supply)</li> <li>Communication with the COM800/COM100 breaker data server via the 3VA-line</li> <li>Including a T-Connector</li> </ul>	✓	—	3VA9177-0TB10
		—	✓	3VA9377-0TB10

## Breaker data server

	Type	Part Number
	COM800 breaker data server <ul style="list-style-type: none"> <li>2 terminating resistors</li> <li>Central communication module for connecting up to eight 3VA6 molded case circuit breakers via the 3VA-line</li> <li>Ethernet 10/100 Mbit/s interface</li> <li>Module slot for plugging on an optional PROFIBUS DP, PROFINET or RS485 module</li> </ul>	3VA9977-0TA10
	COM100 breaker data server <ul style="list-style-type: none"> <li>2 terminating resistors</li> <li>Central communication module for connecting up to eight 3VA6 molded case circuit breakers via the 3VA-line</li> <li>Ethernet 10/100 Mbit/s interface</li> <li>Module slot for plugging on an optional PROFIBUS DP, PROFINET or RS485 module</li> </ul>	3VA9977-0TA20
	7KM PAC PROFIBUS DP expansion module <ul style="list-style-type: none"> <li>The 7KM PAC PROFIBUS DP expansion module is used for connecting the COM800/COM100 breaker data server, and the 3VA molded case circuit breakers connected to it, to PROFIBUS DPV1</li> <li>The 7KM PAC PROFIBUS DP expansion module provides the status and measured quantities of the 3VA molded case circuit breaker for the PROFIBUS DP master. It receives information (e.g. commands) from the PROFIBUS DP master, and forwards this information to the 3VA molded case circuit breaker</li> </ul>	7KM9300-0AB01-0AA0
	7KM PAC Switched Ethernet PROFINET expansion module <ul style="list-style-type: none"> <li>The 7KM PAC Switched Ethernet PROFINET expansion module is used to connect the COM800/COM100 breaker data server, and the connected 3VA molded case circuit breaker, to PROFINET via two Ethernet interfaces</li> <li>The 7KM PAC Switched Ethernet PROFINET expansion module provides the status and measured quantities of the 3VA molded case circuit breaker to PROFINET via the PROFINET IO, PROFinenergy and Modbus TCP protocols</li> </ul>	7KM9300-0AE01-0AA0
	7KM PAC RS485 Modbus RTU expansion module <ul style="list-style-type: none"> <li>The 7KM PAC RS485 Modbus expansion module is used to connect the COM800/COM100 breaker data server, and the 3VA molded case circuit breaker connected to it, to Modbus RTU</li> <li>The 7KM PAC RS485 Modbus expansion module provides the status and measured quantities of the 3VA molded case circuit breaker for the Modbus RTU master. It receives information (e.g. commands) from the Modbus RTU master, and forwards this information to the 3VA molded case circuit breaker</li> </ul>	7KM9300-0AM00-0AA0

# 3VA Molded Case Circuit Breakers

3VA Communication and Testing/Commissioning Devices

Selection

## Accessories for Communication





	Type	Part Number
	T-Connector <ul style="list-style-type: none"> <li>■ Spare part</li> <li>■ Provides spur line feeder to COM060 and loops to the next circuit breaker</li> <li>■ Includes a connection adapter for mounting on the 3VA6 breaker enclosure</li> </ul>	<b>3VA9987-0TG10</b>
	DIN rail adapter For snapping the T-Connector onto a DIN rail	<b>3VA9987-0TG11</b>
	Preassembled T-Connector-to-T-Connector or T-Connector-to-COM800/ COM100 connecting cable <ul style="list-style-type: none"> <li>■ 0.4 m long</li> </ul>	<b>3VA9987-0TC10</b>
	<ul style="list-style-type: none"> <li>■ 1 m long</li> </ul>	<b>3VA9987-0TC20</b>
	<ul style="list-style-type: none"> <li>■ 2 m long</li> </ul>	<b>3VA9987-0TC30</b>
	<ul style="list-style-type: none"> <li>■ 4 m long</li> </ul>	<b>3VA9987-0TC40</b>
	Preassembled connecting cable for extending the COM060-to-T-Connector spur line connection <ul style="list-style-type: none"> <li>■ 0.4 m long</li> </ul>	<b>3VA9987-0TF20</b>
	<ul style="list-style-type: none"> <li>■ 0.8 m long</li> </ul>	<b>3VA9987-0TF10</b>
	Additional bus terminating resistors	<b>3VA9987-0TE10</b>
	Voltage tap to external N conductor Cable for connecting the neutral point for the metering function of the 8-Series ETU, length 1.5 m	<b>3VA9987-0UC10</b>
	External current transformer as straight-through transformer. Connection of an external current transformer for the N conductor for 3-pole 3VA6 molded case circuit breakers for 5-series and 8-series ETUs (ETU850, ETU856, ETU860), including connecting cable	
	<ul style="list-style-type: none"> <li>■ <math>I_n = 25 \dots 150\text{A}</math></li> </ul>	<b>3VA9077-0NA10</b>
	<ul style="list-style-type: none"> <li>■ <math>I_n = 160 \dots 350\text{A}</math></li> </ul>	<b>3VA9177-0NA10</b>
<ul style="list-style-type: none"> <li>■ <math>I_n = 400 \dots 630\text{A}</math></li> </ul>	<b>3VA9377-0NA10</b>	
	DSP800 display <ul style="list-style-type: none"> <li>■ For displaying the status, measured values and parameters of up to 8 3VA6 molded cases circuit breakers</li> <li>■ Connection to the COM800/COM100 via Ethernet for displaying information of the COM800/COM100 and the connected 3VA6 molded case circuit breaker</li> </ul>	<b>3VA9977-0TD10</b>
	EFB300 <ul style="list-style-type: none"> <li>■ External function box for connection to the ETU of the 3VA6 molded case circuit breaker</li> <li>■ 4 digital outputs for information output, 1 digital input</li> <li>■ ZSI functionality</li> <li>■ S0 interface</li> <li>■ Including cable 1.5 m in length</li> </ul>	<b>3VA9977-0UA10</b>
	Connecting cable for EFB300. Spare part <ul style="list-style-type: none"> <li>■ 1.5 m long</li> </ul>	<b>3VA9987-0UB10</b>
<ul style="list-style-type: none"> <li>■ 3.0 m long</li> </ul>	<b>3VA9987-0UB20</b>	
<ul style="list-style-type: none"> <li>■ 3.0 m long for 3VA with EFB and RCD820</li> </ul>	<b>3VA9987-0UB30</b>	

# 3VA Molded Case Circuit Breakers

3VA Communication and Testing/Commissioning Devices

Selection

## Test devices

	Type	Part Number
	<b>TD300</b> <ul style="list-style-type: none"> <li>■ Connection to the front interface of the ETU</li> <li>■ Test device for activating the ETU and triggering a test trip</li> </ul>	<b>3VA9977-0MA10</b>
	<b>TD500</b> <ul style="list-style-type: none"> <li>■ Connection to the front interface of the ETU</li> <li>■ Initiation of various test trips (LSING)</li> <li>■ USB interface for connection of a PC using powerconfig</li> <li>■ ETU parameterization</li> <li>■ Including external power supply unit with adapter for Europe, UL and GB</li> <li>■ Including connecting cable to the 3VA6 molded case circuit breaker</li> </ul>	<b>3VA9977-0MB10</b>
	Spare part: External power supply for TD500 110 ... 240 V AC	<b>3VA9987-0MX10</b>
	Spare part: Cable for connecting to the TD500 to the 3VA6 molded case circuit breaker	<b>3VA9977-0MY10</b>

## Maintenance Mode Box







	<b>MMB300</b> <ul style="list-style-type: none"> <li>■ Realization of the NEC 240.87 (Arc Energy Reduction) -&gt; personal protection during maintenance work</li> <li>■ Switch into maintenance mode by changing the I- and G-protection to the lowest possible value through an external signal (e.g. door contact)</li> <li>■ Available for all 3VA6 circuit breakers with electronic trip unit</li> <li>■ Daisy chain up to 8 circuit breakers equipped with MMB300</li> <li>■ Additional digital output (D01) for ETU signals available</li> <li>■ Capable of DIN rail mounting</li> </ul>	<b>3VA9977-0UF10</b>
---	---	----------------------

# 3VA Molded Case Circuit Breakers

## 3VA Accessories for Locking, Blocking and Interlocking

Selection

### Locking, Blocking, & Interlocking



	Type	For molded case circuit breakers/rated current				Part Number	
		3VA5 125 A	3VA5 250 A	3VA6 150 A 250 A	3VA6 400 A 600 A		
	Blocking device for the handle	✓	—	—	—	3VA9038-0LB10	
		—	✓	✓	✓	3VA9378-0LB10	
	Adapter kit for mounting the cylinder lock (type Ronis) in the accessories compartment of the molded case circuit breaker Comprising 2 cylinder lock casings (one for locking and one for interlocking) and the appropriate mounting module <ul style="list-style-type: none"> <li>To implement an interlock or a lock: select suitable cylinder lock(s)</li> <li>For an interlock: select the same cylinder lock number</li> </ul>	✓	—	—	—	3VA9137-0LF10	
		—	✓	—	—	3VA9237-0LF10	
		—	—	✓	—	3VA9147-0LF10	
		—	—	—	✓	3VA9347-0LF10	
	Cylinder lock (type Ronis) <ul style="list-style-type: none"> <li>Includes a lock with 2 keys</li> <li>For locking or interlocking</li> <li>For installation in all rotary operators with shaft stub</li> <li>For mounting in the adapter kit for the accessories compartment</li> </ul>						
		<ul style="list-style-type: none"> <li>Key 1 (lock number 1)</li> </ul>	✓	✓	✓	✓	3VA9980-0VL10
		<ul style="list-style-type: none"> <li>Key 2 (lock number 2)</li> </ul>	✓	✓	✓	✓	3VA9980-0VL20
		<ul style="list-style-type: none"> <li>Key 3 (lock number 3)</li> </ul>	✓	✓	✓	✓	3VA9980-0VL30
		<ul style="list-style-type: none"> <li>Key 4 (lock number 4)</li> </ul>	✓	✓	✓	✓	3VA9980-0VL40
	Sliding bar Complete kit for interlocking 2 circuit breakers <ul style="list-style-type: none"> <li>The article number must be ordered 2X to implement an interlock between 3 breakers of the same size</li> </ul>	✓	—	—	—	3VA9138-0VF30	
		—	✓	—	—	3VA9238-0VF30	
		—	—	✓	—	3VA9148-0VF30	
		—	—	—	✓	3VA9348-0VF30	
	Module for handle interlock using a bowden cable <ul style="list-style-type: none"> <li>A separate handle interlock module is required for each switching device</li> <li>A Bowden cable must be ordered separately</li> </ul>	✓	—	—	—	3VA9137-0VF10	
		—	✓	—	—	3VA9237-0VF10	
		—	—	✓	—	3VA9147-0VF10	
		—	—	—	✓	3VA9347-0VF10	
	Rear interlock with rod Complete Kit <ul style="list-style-type: none"> <li>Mounting frames are not included in scope of supply</li> </ul>	✓	✓	✓	✓	3VA9078-0VM10	
	Rear interlock with rod Complete Kit for plug-in/draw-out unit <ul style="list-style-type: none"> <li>Mounting frames are not included in scope of supply</li> </ul>	✓	✓	✓	✓	3VA9078-0VM30	

# 3VA Molded Case Circuit Breakers



## 3VA Accessories for Locking, Blocking and Interlocking

Selection

### Locking, Blocking, & Interlocking

	Type	For molded case circuit breakers/rated current				Part Number
		3VA5 125 A	3VA5 250 A	3VA6 150 A 250 A	3VA6 400 A 600 A	
	Bowden cable					
	▪ Length 0.6 m	✓	✓	✓	✓	3VA9980-0VC10
	▪ Length 1.0 m	✓	✓	✓	✓	3VA9980-0VC20
	▪ Length 1.5 m	✓	✓	✓	✓	3VA9980-0VC30
	Mounting frame for rear interlock with rod <sup>②</sup> The following are required for the complete mounting frame kit:					
	▪ Profile poles	✓	✓	✓	✓	3VA9078-0VK10
	▪ Mounting Plates	✓	—	—	—	3VA9138-0VK20
		—	✓	—	—	3VA9238-0VK20
		—	—	✓	—	3VA9248-0VK20
		—	—	—	✓	3VA9448-0VK20

### Cover frame for door cut-out

	Cover frame for door cut-out for molded case circuit breaker	✓	—	—	—	3VA9033-0SB10
	▪ 3-pole, door cut-out without trip unit	—	✓	✓	—	3VA9143-0SB10
		—	—	—	✓	3VA9373-0SB10
	Cover frame for door cut-out for molded case circuit breaker	✓	—	—	—	3VA9033-0SB20
	▪ 3-pole, door cut-out with trip unit	—	✓	—	—	3VA9233-0SB20
		—	—	✓	—	3VA9143-0SB20
		—	—	—	✓	3VA9343-0SB20
	Cover frame for door cut-out for molded case circuit breaker	✓	—	—	—	3VA9034-0SB10
	▪ 4-pole, door cut-out without trip unit	—	✓	✓	—	3VA9144-0SB10
		—	—	—	✓	3VA9374-0SB10
	Cover frame for door cut-out for molded case circuit breaker	✓	—	—	—	3VA9034-0SB20
	▪ 4-pole, door cut-out with trip unit	—	✓	—	—	3VA9234-0SB20
		—	—	✓	—	3VA9144-0SB20
		—	—	—	✓	3VA9344-0SB20
	Cover frame for door cut-out for MO320 motor operators	✓	—	—	—	3VA9033-0SB10
	—	✓	✓	—	3VA9237-0SB30	
	—	—	—	✓	3VA9377-0SB30	
Cover frame for door cut-out for front mounted rotary operators	✓	—	—	—	3VA9033-0SB10	
	—	✓	✓	—	3VA9143-0SB10	
	—	—	—	✓	3VA9373-0SB10	
Cover frame for door cut-out for front mounted rotary operator with door interlock	—	—	—	✓	3VA9377-0SB30	
Cover frame for door cut-out for door feedthrough	—	✓	✓	—	3VA9233-0SB20	
	—	—	—	✓	3VA9333-0SB20	
	Labeling plate for cover frame					3VA9087-0SX10

② 2 mounting plates are required. They are screwed onto the profile rail that can be ordered above. Different breakers can be mutually interlocked.



③ Breakers with plug-in unit can be mounted on the mounting plates, but the profile rails cannot be used.

# 3VA Molded Case Circuit Breakers

3VA Accessories and Spare Parts

Selection

## Other accessories

	Type	For molded case circuit breakers/rated current				Part Number
		3VA5 125 A	3VA5 250 A	3VA6 150 A 250 A	3VA6 400 A 600 A	
	Busbar adapter system with 60 mm busbar center-to-center spacing 3-pole	✓	—	—	—	8US1211-4SS00
		—	✓	✓	—	8US1213-4AP03
		—	—	—	✓	8US1213-4AH04
	Metric mounting screw kit For fixed mounted breakers 1-pole	✓	—	—	—	3VA9151-0SS10
	Metric mounting screw kit (2 pcs) For fixed mounted breakers 2-pole	✓	—	—	—	3VA9116-0SS10
	Metric mounting screw kit (4 pcs) For fixed mounted breakers 3-,4-pole	✓	✓	—	—	3VA9114-0SS10
	Metric mounting screw kit For fixed mounted breakers 3-pole	—	—	✓	—	3VA9126-0SS10
	Metric mounting screw kit For fixed mounted breakers 4-pole	—	—	✓	—	3VA9124-0SS10
	Metric mounting screw kit For fixed mounted breakers 3-,4-pole	—	—	—	✓	3VA9328-0SS10
	Metric mounting screw kit For plug-in and draw-out unit	—	—	✓	—	3VA9124-0SS10
	SAE mounting screw kit (2 pcs) For fixed mounted breakers 1-pole	✓	—	—	—	3VA9151-0SS00
	SAE Mounting screw kit (2 pcs) For fixed mounted breakers 2-,3-pole	✓	—	—	—	3VA9156-0SS00
	SAE Mounting screw kit (4 pcs) For fixed mounted breakers 3-,4-pole and 3VA6 150/250 plug-in and draw-out units	—	✓	✓	—	3VA9164-0SS00
	SAE Mounting screw kit (2 pcs) For fixed mounted breakers 2-,3-pole	—	✓	✓	—	3VA9166-0SS00
	SAE Mounting screw kit (4 pcs) For fixed mounted breakers 2-,3-,4-pole and 3VA6 400/600 plug-in and draw-out units	—	—	—	✓	3VA9368-0SS00



# 3VA Molded Case Circuit Breakers

## 3VA Accessory Electrical Requirements

Technical data

### Auxiliary switches electrical requirements

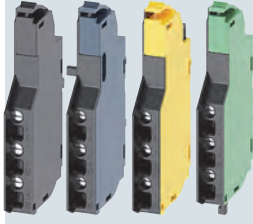
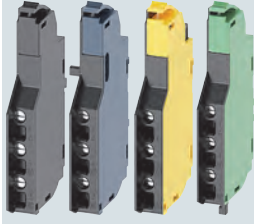
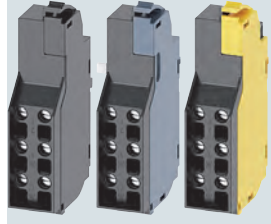



				Auxiliary switches and alarm switches HQ 				Auxiliary switches and alarm switches HQ_electronic 				Auxiliary switches and alarm switches HP 		
				AUX	LCS	TAS	EAS	AUX	LCS	TAS	EAS	AUX	LCS	TAS
Rated operational voltage	$U_e$	V AC 50 Hz		240				24				600		
		V DC		250				24				250		
Conventional free-air thermal current	$I_{th} = I_e$	A		6				0.3				10		
IEC Ratings Listed	AC-12	12 V	A	6				0.3				10		
		24 V	A	6				0.3				10		
		48 V	A	6				--				10		
		125 V	A	6				--				10		
		220/240 V	A	6				--				10		
		380/440 V	A	--				--				6		
		600 V	A	--				--				2		
	AC-15	12 V	A	3				0.3				6		
		24 V	A	3				0.3				6		
		48 V	A	3				--				6		
		125 V	A	3				--				6		
		220/240 V	A	3				--				6		
		380/440 V	A	--				--				2		
	DC-12	12 V	A	6				0.1				6		
24 V		A	4				0.1				6			
48 V		A	2				--				2			
110 V		A	0.5				--				0.6			
250 V		A	0.25				--				0.3			
DC-13	12 V	A	1				0.07				3			
	24 V	A	0.8				0.07				3			
	48 V	A	0.4				--				0.8			
	110 V	A	0.2				--				0.2			
	250 V	A	0.1				--				0.1			
Max. rated current (UL/CSA)	Inductive load (0.75-0.8 AC)	24 V	A	3				0.3				6		
		300 V	A	3				--				6		
		600 V	A	--				--				6		
	Pilot duty (AC)	24 V	A	3				--				6		
		127 V	A	3				--				6		
		240 V	A	3				--				3		
		480 V	A	--				--				1.5		
		600 V	A	--				--				1.2		
	Resistive load (DC)	24 V	A	0.25				0.1				0.3		
		250 V	A	0.25				--				0.3		
	Resistive load - pilot duty sequence (DC)	125 V	A	0.6				--				0.9		
		250 V	A	0.3				--				0.55		
Minimum load	At 24 V DC	mA	70				0.5				70			
	At 5 V DC	mA	--				1				--			

# 3VA Molded Case Circuit Breakers

## 3VA Accessory Electrical Requirements

Technical data

### Shunt trip/undervoltage electrical requirements





				Shunt trip left STL	Shunt trip flexible STF	Undervoltage releases UVR	Universal release UNI
							
Power consumption $U_e$	12	V DC	W	50	--	--	--
	24	50 V AC/60 Hz	VA	50	--	--	--
	24 ... 30	V DC	W	7 ... 50	--	--	--
	48 ... 60	50 V AC/60 Hz	VA	15 ... 20	--	--	--
	48 ... 60	V DC	W	20 ... 30	--	--	--
	110 ... 127	50 V AC/60 Hz	VA	30 ... 40	--	--	--
	110 ... 127	V DC	W	30 ... 40	--	--	--
	208 ... 277	50 V AC/60 Hz	VA	16 ... 35	--	--	--
	220 ... 250	V DC	W	28 ... 35	--	--	--
	380 ... 600	50 V AC/60 Hz	VA	10 ... 30	--	--	--
	24	50 V AC/60 Hz	VA	--	300	--	--
	48 ... 60	50 V AC/60 Hz	VA	--	340 ... 600	--	--
	110 ... 127	50 V AC/60 Hz	VA	--	500 ... 650	--	--
	208 ... 277	50 V AC/60 Hz	VA	--	360 ... 650	--	--
	380 ... 500	50 V AC/60 Hz	VA	--	330 ... 600	--	--
	600	50 V AC/60 Hz	VA	--	300	--	--
	12	V DC	W	--	--	< 2.5	--
	24	V DC	W	--	--	< 2.5	--
	48	V DC	W	--	--	< 2.5	--
	60	V DC	W	--	--	< 2.5	--
	125 ... 127	V DC	W	--	--	< 2.5	--
	220 ... 230	V DC	W	--	--	< 2.5	--
	250	V DC	W	--	--	< 2.5	--
	24	50 V AC/60 Hz	VA	--	--	< 2	--
	48	50 V AC/60 Hz	VA	--	--	< 2	--
	60	50 V AC/60 Hz	VA	--	--	< 2	--
	110	50 V AC/60 Hz	VA	--	--	< 2	--
	120 ... 127	50 V AC/60 Hz	VA	--	--	< 2	--
	208 ... 230	50 V AC/60 Hz	VA	--	--	< 2	--
	380 ... 400	50 V AC/60 Hz	VA	--	--	< 2.5	--
	440 ... 480	50 V AC/60 Hz	VA	--	--	< 2.5	--
	12	V DC (Cat II; PELV/SELV)	W	--	--	--	UVR: < 2.5 SHT: 20
	24	V DC (Cat II; PELV/SELV)	W	--	--	--	UVR: < 2.5 SHT: 20
48	V DC (Cat II; PELV/SELV)	W	--	--	--	UVR: < 2.5 SHT: 20	

# 3VA Molded Case Circuit Breakers

## 3VA Accessory Electrical Requirements

Technical data

### Shunt trip/undervoltage electrical requirements

				Shunt trip left STL	Shunt trip flexible STF	Undervoltage releases UVR	Universal release UNI
							
<b>Rated impulse withstand voltage</b>	$U_{imp}$	kV	6			4	0.5
<b>Making current</b>	$I_{max}$	at V	1.5 A/24 V AC	18 A/24 V AC	5 mA/480 V	1.5 A/24 V	
<b>Maximum tripping time</b>		ms	< 10				
<b>Service life</b>	Electrical trips		8500				
	Mechanical switching cycles of the circuit breaker		25000				
<b>Priority over other control signals</b>			Given				
<b>Degree of protection</b>	Lid of the accessories compartment closed		IP40				
	Lid of the accessories compartment open		IP 20				
<b>Minimum signal duration</b>		ms	40	40	--	40	
<b>Response voltage shunt trip</b>	Pick-up (circuit breaker trips)	Us/V	%	70 ... 110		--	70 ... 110
<b>Undervoltage release response voltage</b>	Pick-up (circuit breaker can be switched on)	Us/V	%	--	--	85 ... 110	
	Pick-up (circuit breaker trips)	Us/V	%	--	--	35 ... 70	
<b>Tripping frequency</b>	Trips per hour		Unlimited	120	Unlimited		
<b>Can be used for electrical interlocking of molded case circuit breakers</b>			No	No	Yes		

### Motor operator electrical requirements

MO320 motor operator	3VA5	3VA5	3VA6	
	125 A	250 A	150 A/ 250 A	400 A/ 600 A
Degree of protection	NEMA 1			
Rated control supply voltage (operating range of control supply voltage)	24 V ... 60 V DC (0.85 ... 1.26) 110 V ... 230 V AC/ 110 V ... 250 V DC (0.85 ... 1.1)			
Rating	250 W, max. 500 W (60 ms)			
Make time, typically	< 800 ms	< 1000 ms	< 1700 ms	
Break time, typically	< 800 ms	< 1000 ms	< 1400 ms	



# Sentron Molded Case Circuit Breakers

Catalog Numbering System

Selection/Application

If used on 250A frame and above means non-interchangeable trip breaker with factory assembled frame and trip. Solid state trip and current limiting (S or C in first character) are non-interchangeable only, and the "X" is omitted.



**Trip Unit Type**

- Omitted — Thermal-Magnetic
- S — Sensitrip® Electronic Trip

**Sentron Series Type/Interrupting Range**

- Omitted — Standard Rating
- H — High IC Rating
- HH — Extra High IC Rating
- C — Highest IC Rating and Current Limiting

**Frame Identifier**

- E — Type ED
- F — Type FD
- J — Type JD
- L — Type LD
- LM — Type LMD
- M — Type MD
- N — Type ND
- P — Type PD
- R — Type RD

**Maximum Voltage**

- 2 — 240 Vac
- 4 — 480 Vac
- 6 — 600 Vac

**Number of Poles**

- 1
- 2
- 3
- A — used to indicate advanced electronic trip unit with maintenance mode capability (always 3 poles)
- B — used to indicate basic electronic trip unit (always 3 poles)

**(Specific Application Type)**

- B — Standard 40°C Breaker
- M — Calibrated for 50°C Application
- F — Frame Only
- T — 40°C Trip Unit Only
- W — 50°C Trip Unit Only
- S — Molded Case Switch
- L — Low Instantaneous Range ETI Breaker
- A — Standard Range ETI Breaker
- H — High Instantaneous Range ETI Breaker

**Maximum Continuous Current Rating**

- ED Frame — 015, 020, 025, 030, 035, 040, 045, 050, 060, 070, 080, 090, 100, 110, 125
- FD Frame — 070, 080, 090, 100, 110, 125, 150, 175, 200, 225, 250
- JD Frame — 200, 225, 250, 300, 350, 400
- LD Frame — 250, 300, 350, 400, 450, 500, 600
- LMD Frame — 500, 600, 700, 800
- MD Frame — 500, 600, 700, 800
- ND Frame — 900, 100 (1000A), 120 (1200A)
- PD Frame — 120 (1200A), 140 (1400A), 160 (1600A)
- RD Frame — 160 (1600A), 180 (1800A), 200 (2000A)

**Suffix**

- L — where applicable indicates a breaker shipped with line/loads lugs installed
- A — used with a switch to show automatic self protection
- Y — 400 Hertz
- H — 100% rated
- P — Load side lugs only
- NAV — Navel Ratings

**NOTE:**

- Position omitted if not used.

# Molded Case Circuit Breakers

ED 125A Frame Sentron Series

Selection

## Ordering Instructions

- All ED Frame Sentron circuit breakers are supplied with load side lugs. If line side lugs are required, add "L" suffix to catalog number. Consult Siemens sales office for any additional charge
- 50°C Calibration, 400HZ - see page 7-138. All ED frame circuit breakers may be reverse connected

## Type ED2<sup>⑤</sup>

Blue Label

Continuous Current Rating @ 40°C	1-Pole		2-Pole		3-Pole
	120V AC	125V DC	240V AC	125V DC 250V DC	240V AC
	Catalog Number		Catalog Number		Catalog Number
15	ED21B015 <sup>④</sup> ■	—	ED22B015	—	ED23B015
20	ED21B020 <sup>④</sup> ■	—	ED22B020	—	ED23B020
25	ED21B025■	—	ED22B025■	—	ED23B025■
30	ED21B030■	—	ED22B030	—	ED23B030
35	ED21B035■	—	ED22B035■	—	ED23B035■
40	ED21B040■	—	ED22B040	—	ED23B040
45	ED21B045■	—	ED22B045■	—	ED23B045■
50	ED21B050■	—	ED22B050	—	ED23B050
60	ED21B060■	—	ED22B060	—	ED23B060
70	ED21B070■	—	ED22B070	—	ED23B070
80	ED21B080■	—	ED22B080■	—	ED23B080
90	ED21B090■	—	ED22B090■	—	ED23B090■
100	ED21B100■	—	ED22B100	—	ED23B100

## Shipping Weights

Number of Poles	Number per Carton	Shipping Weight (lbs.)
<b>ED2, ED4, ED6, HED4, HHED6</b>		
1	30	38
2	10	25
3	10	38
<b>CED6</b>		
2	5	20
3	5	30

## Lugs

Ampere Rating	No. of Poles	Catalog Number	Wire Range
<b>Aluminum Body Lugs</b>			
All 15–25A	1, 2, 3	Line/Load SA1E025	#14–#10 Cu #12–#10 Al
All 30–100A	1, 2, 3	Line Side LN1E100	#10–1/0 Cu/Al
ED2, 4, CED6 30–60A	1	Load Side LD1E060	#10–#4 Cu/Al
ED2, 4, CED6 70–100A	1	Load Side LD1E100	#6–#1/0 Cu/Al
ED2, 4, HED4, HHED6 30–100A	2, 3	Load Side LN1E100	#10–1/0 Cu/Al
ED6 20–50A	2, 3	Line Side LN1E100	#10–1/0 Cu/Al
All 110, 125A	2, 3	Line/Load TA1E6125	#3–3/0 Cu #1–2/0 Al
<b>Copper Body Lugs</b>			
All 30–125A	1, 2, 3	Line/Load TC1E6150 <sup>③</sup>	#10–1/0 Cu only
<b>Compression Lugs</b>			
All ED, HHED, CED		CCE125	2/0

## Type ED4<sup>⑤</sup>

Blue Label

Continuous Current Rating @ 40°C	1-Pole		2-Pole		3-Pole
	120V AC	125V DC	480V AC	250V DC	480V AC
	Catalog Number		Catalog Number		Catalog Number
15	ED41B015 <sup>④</sup>	—	—	—	ED43B015
20	ED41B020 <sup>④</sup>	—	ED42B020	—	ED43B020
25	ED41B025	—	ED42B025	—	ED43B025
30	ED41B030	—	ED42B030	—	ED43B030
35	ED41B035■	—	ED42B035■	—	ED43B035
40	ED41B040	—	ED42B040	—	ED43B040
45	ED41B045■	—	ED42B045■	—	ED43B045
50	ED41B050	—	ED42B050	—	ED43B050
60	ED41B060	—	ED42B060	—	ED43B060
70	ED41B070	—	ED42B070	—	ED43B070
80	ED41B080■	—	ED42B080■	—	ED43B080
90	ED41B090■	—	ED42B090■	—	ED43B090
100	ED41B100	—	ED42B100	—	ED43B100
110	ED41B110	—	ED42B110■	—	ED43B110
125	—	—	ED42B125	—	ED43B125

## Type ED6<sup>⑤</sup>

Blue Label

Continuous Current Rating @ 40°C	1-Pole <sup>①</sup>	2-Pole		3-Pole		3-Pole
	347V AC	600V AC	250V DC	600V AC	500V DC	600V DC
	Catalog Number	Catalog Number	Catalog Number	Catalog Number	Catalog Number	Catalog Number
15	ED61B015	—	—	—	—	ED63D015L
20	ED61B020	ED62B020	—	ED63B020	—	ED63D020L
25	ED61B025	ED62B025■	—	ED63B025	—	ED63D025L
30	ED61B030	ED62B030	—	ED63B030	—	ED63D030L
35	ED61B035	—	—	ED63B035	—	ED63D035L
40	ED61B040	—	—	ED63B040	—	ED63D040L
45	ED61B045■	—	—	ED63B045	—	ED63D045L
50	ED61B050	—	—	ED63B050	—	ED63D050L
60	ED61B060	—	—	ED63B060	—	ED63D060L
70	ED61B070■	—	—	ED63B070	—	—
80	ED61B080	—	—	ED63B080	—	—
90	ED61B090	—	—	ED63B090	—	—
100	ED61B100■	—	—	ED63B100	—	—
110	—	—	—	ED63B110	—	—
125	—	—	—	ED63B125	—	—

## Enclosures (Neutral Included)<sup>⑤</sup>

Type	Catalog Number
1 (Surface)	E2N1S (15–100A)
1 (Flush)	E2N1F (15–100A)
3R	E2N3R (15–100A)
4–4X	ED6SS4 (15–125A)
4–4X	ED6S4 (15–100A)
4–4X (316SS)	ED6S4316 (15–100A)
7–9	EA (15–60A)
7–9	EB (70–100A)
12	E2N12 (15–100A)
1 (Surface)	CED6N1S <sup>②</sup>
1 (Flush)	CED6N1F <sup>②</sup>
3R	CED6N3R <sup>②</sup>
12	CED6N12 <sup>②</sup>

Note: ED frame circuit breakers qualified to UL 489 Supplement SB "Naval"— See page 7-138 for additional information

- Built to order. Allow 2–3 weeks for delivery.
- ① CSA Certified only (Not UL)

② For CED types and all 110–125 ampere ED frames.

③ See Note: A, page 7-135.

④ SWD rated.

⑤ HACR rated.

⑥ Not for use with HHED6 breakers.

Modifications page 7-138  
Enclosures Section 6  
Accessories pages 7-95 and 7-142 to 7-147

# Molded Case Circuit Breakers

ED 125A Frame Sentron Series

Selection/Dimensions

## Type HED4<sup>5</sup>

**Black Label**

Continuous Current Rating @ 40°C	1-Pole		2-Pole		3-Pole
	277V AC	125V DC	480V AC	250V DC	480V AC
	Catalog Number		Catalog Number		Catalog Number
15	HED41B015 <sup>①</sup>		HED42B015		HED43B015
20	HED41B020 <sup>①</sup>		HED42B020		HED43B020
25	HED41B025		HED42B025■		HED43B025
30	HED41B030		HED42B030		HED43B030
35	HED41B035■		HED42B035■		HED43B035
40	HED41B040		HED42B040		HED43B040
45	HED41B045■		HED42B045■		HED43B045
50	HED41B050■		HED42B050		HED43B050
60	HED41B060■		HED42B060■		HED43B060
70	HED41B070■		HED42B070■		HED43B070
80	HED41B080■		HED42B080■		HED43B080
90	HED41B090■		HED42B090■		HED43B090
100	HED41B100■		HED42B100■		HED43B100
110	—		HED42B110■		HED43B110
125	—		HED42B125■		HED43B125

FIGURE 1 - ED, HED, HHED

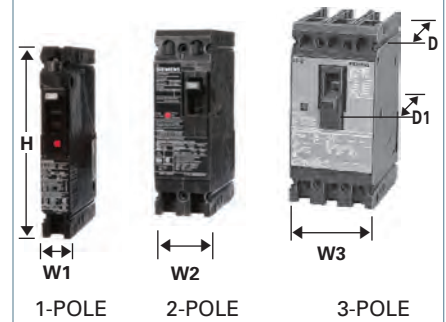
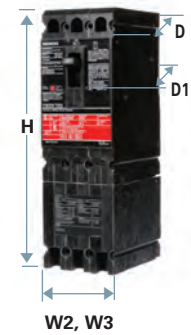

FIGURE 2 - CED (3-Pole shown)



Dimensions (in inches)

Breaker Type	W1	W2	W3	H	D	D1
Figure 1 ED2, ED4, ED6, HED4, ED6 ETI <sup>③</sup>	1	2	3	6.35	3.92	4.56
Figure 1 HHED6	—	2	3	6.53	3.92	4.56
Figure 2 CED6, CED6 ETI <sup>③</sup>	—	2	3	9.58	3.92	4.56

## Fuseless Current Limiting

### Type HHED6<sup>5</sup>

**Black Label**

### Type CED6<sup>5</sup>

**Red Label**

Continuous Current Rating @ 40°C	3-Pole		2-Pole	3-Pole
	600V AC		600V AC, 250V DC	600V AC, 500V DC <sup>②</sup>
	Catalog Number <sup>④</sup>		Catalog Number	Catalog Number
15	HHED63B015A		CED62B015	CED63B015
20	HHED63B020		CED62B020■	CED63B020
25	HHED63B025		—	—
30	HHED63B030		CED62B030■	CED63B030
35	HHED63B035		—	—
40	HHED63B040		—	CED63B040
45	HHED63B045		—	—
50	HHED63B050		—	CED63B050
60	—		CED62B060■	CED63B060
70	—		CED62B070■	CED63B070
80	—		CED62B080■	CED63B080
90	—		CED62B090■	CED63B090
100	—		CED62B100■	CED63B100
110	—		—	CED63B110■
125	—		CED62B125■	CED63B125

## Interrupting Ratings

Breaker Type	UL 489 AIR (File #E10848)										IEC 947-2					
	RMS Symmetrical Amperes (KA)															
	Volts AC						Volts DC				220/240			380/415		500
	120	240	277	347	480	600	125	250	500 <sup>②</sup>	600	Icu	Ics	Icu	Ics	Icu	Ics
ED2 (1-P)	10	—	—	—	—	—	5	—	—	—	—	—	—	—	—	—
ED2 (2, 3-P)	—	10	—	—	—	—	—	5 (2-P)	—	—	—	—	—	—	—	—
ED4 (1-P)	65	—	22	—	—	—	30	—	—	—	—	—	—	—	—	—
ED4 (2, 3-P)	—	65	—	—	18	—	—	30 (2-P)	—	—	—	—	—	—	—	—
ED6 (1P)	—	—	—	30 <sup>④</sup>	—	—	—	30	—	—	—	—	—	—	—	—
ED6 (2, 3-P)	—	65	—	—	25	18	—	—	18 (3-P)	65	17	35	9	18	5	
ED6 (3-P)	—	—	—	—	—	—	—	—	—	—	—	—	—	—	—	
HED4 (1-P) (15-30A)	100	—	65	—	—	—	30	—	—	—	—	—	—	—	—	
HED4 (1-P) (35-100A)	100	—	25	—	—	—	30	—	—	—	—	—	—	—	—	
HED4 (2, 3-P)	—	100	—	—	42	—	—	30 (2-P)	—	—	—	—	—	—	—	
HHED6 (2, 3-P)	—	100	—	—	65	18 <sup>④</sup>	—	—	—	—	—	—	—	—	—	
CED6 (2, 3-P)	—	200	—	—	200	100	—	50 (2-P)	30 (3-P)	—	—	—	—	—	—	

■ Built to order. Allow 2-3 weeks for delivery.

①SWD rated.

②When wired as shown on page 7-4, this circuit breaker is UL listed and rated for use on 500V DC ungrounded UPS systems.

③ ED6-ETI, CED6-ETI, see page 7-122 for ordering information.

④ Single Pole 15-30A 30KA @ 347V non-UL. 35-100A 18KA @ 347V non-UL.

⑤ HACR rated.

⑥ HHED63B015A is rated 18KAIC at 600/347V.

# Molded Case Circuit Breakers

Accessories for:

## ED 125A Frame



### Combinations

Available only when ordered together. Only one module can be added to a breaker. Additional accessories, which always attach to the left pole, cannot be added to the combination later. Adds 1 inch pole space.

### Equipment Ground Sensing

A field addable kit containing 30mA or 5 mA ground fault accessory module, current transformer with 24 inch leads, and current transformer mounting equipment. Current transformer to mount in gutter of lighting panel or any control panel. Accessory module operates from separate 120V control power source.

Both 30MA and 5MA devices are equipment protection devices only. Do not use for personnel protection.



## Shunt Trip Combinations

Control Voltage		1 Shunt Trip	1 Shunt Trip and 1 Auxiliary Switch	1 Shunt Trip and 1 Auxiliary Switch and 1 Alarm Switch	1 Shunt Trip and 1 Alarm Switch	1 Shunt Trip and 2 Auxiliary Switches
AC	DC	Catalog Number	Catalog Number	Catalog Number	Catalog Number	Catalog Number
24		S17ED60	—	—	—	—
48		S18ED60	—	—	—	—
120		S01ED60	S01ED62A	S01ED62AB	S01ED62B	S01ED62AA
208		—	S02ED62A▲	S02ED62AB▲	S02ED62B▲	S02ED62AA▲
240		S03ED60	S03ED62A	S03ED62AB	S03ED62B▲	S03ED62AA▲
277		S15ED60▲	S15ED64A▲	S15ED64AB▲	S15ED64B▲	—
480		S04ED60	S04ED64A▲	S04ED64AB▲	S04ED64B▲	—
	12	S16ED60▲	S16ED62A▲	—	—	—
	24	S07ED60	S07ED62A	S07ED62AB▲	S07ED62B▲	S07ED62AA▲
	48	S09ED60▲	S09ED62A▲	S09ED62AB▲	S09ED62B▲	S09ED62AA▲
	125	S11ED60▲	S11ED62A▲	S11ED62AB▲	S11ED62B▲	S11ED62AA▲
	250	S13ED60▲	S13ED62A▲	S13ED62AB▲	S13ED62B▲	S13ED62AA▲

## Undervoltage Trip Combinations

Control Voltage		1 Undervoltage Trip	1 Undervoltage Trip and 1 Auxiliary Switch	1 Undervoltage Trip and 1 Auxiliary Switch and 1 Alarm Switch	1 Undervoltage Trip and 1 Alarm Switch	1 Undervoltage Trip and 2 Auxiliary Switches
AC	DC	Catalog Number	Catalog Number	Catalog Number	Catalog Number	Catalog Number
120		U01ED60	U01ED62A	U01ED62AB▲	U01ED62B▲	U01ED62AA▲
208		U02ED60▲	U02ED62A▲	U02ED62AB▲	U02ED62B▲	U02ED62AA▲
240		U03ED60	U03ED62A▲	U03ED62AB▲	U03ED62B▲	U03ED62AA▲
277		U16ED60▲	U16ED64A▲	U16ED64AB▲	U16ED64B▲	—
480		U06ED60▲	U06ED64A▲	U06ED64AB▲	U06ED64B▲	—
600		U08ED60▲	—	—	—	—
	24	U13ED60	U13ED62A▲	U13ED62AB▲	U13ED62B▲	U13ED62AA▲
	48	U14ED60▲	U14ED62A▲	U14ED62AB▲	U14ED62B▲	U14ED62AA▲
	125	U10ED60▲	U10ED62A▲	U10ED62AB▲	U10ED62B▲	U10ED62AA▲
	250	U12ED60▲	U12ED62A▲	—	—	U12ED62AA▲

## Auxiliary Switch Combinations

Maximum Voltage		1 Auxiliary Switch	1 Alarm Switch and 1 Auxiliary Switch	2 Auxiliary Switches	1 Alarm Switch and 2 Auxiliary Switches
AC	DC	Catalog Number	Catalog Number	Catalog Number	Catalog Number
240	250	A01ED62	A01ED62B	A02ED62	A02ED62B
480		A01ED64	A01ED64B	—	—

Maximum Voltage		1 Auxiliary Switch	
AC	DC	Catalog Number	
	12	A01EDLV	Gold Plated Contacts—for PLC use

## Alarm Switch Only

Maximum Voltage		1 Alarm Switch	
AC	DC	Catalog Number	
240	250	B00ED62	
480		B00ED64	

## Ground Fault Sensing Relay Kit — Equipment Protection Only

For Use With Breaker Frame	Number of Poles	Description	Catalog Number	
			30mA	5mA
CED6, ED2, ED4 ED6, EFC, EFF, HED4, HHED6	1, 2, 3	Basic Kit	GF01ED60	GF01ED65
		Basic Kit with Normally Open Bell Alarm	GF01ED60B0	GF01ED65B0▲
		Basic Kit with Normally Closed Bell Alarm	GF01ED60BC	GF01ED65BC▲

▲ Built to order. Allow 6–8 weeks for delivery.

# Molded Case Circuit Breakers

FD 250A Frame Sentron Series

Selection

## Type FXD6-A<sup>①⑥</sup>

Blue Label

Non-Interchangeable Trip (Assembled Circuit Breaker – Without Lugs)		
Continuous Current Rating @ 40°C	2-Pole	3-Pole
	Catalog Number	Catalog Number
70	FXD62B070■	FXD63B070
80	FXD62B080■	FXD63B080
90	FXD62B090■	FXD63B090
100	FXD62B100	FXD63B100
110	FXD62B110■	FXD63B110
125	FXD62B125	FXD63B125
150	FXD62B150	FXD63B150
175	FXD62B175	FXD63B175
200	FXD62B200	FXD63B200
225	FXD62B225	FXD63B225
250	FXD62B250	FXD63B250

## Type FD6-A<sup>⑥</sup>

Blue Label

Interchangeable Trip			
Continuous Current Rating @ 40°C	Complete Breaker Unassembled w/Lugs	Frame Only	Trip Unit Only
	Catalog Number	Catalog Number	Catalog Number

### 2-Pole 600V AC, 250V DC<sup>②</sup>

Continuous Current Rating @ 40°C	Catalog Number	Frame Only Catalog Number	Trip Unit Only Catalog Number
70	FD62B070■	FD62F250	FD62T070■
80	FD62B080■		FD62T080■
90	FD62B090■		FD62T090■
100	FD62B100■		FD62T100■
110	FD62B110■		FD62T110■
125	FD62B125■		FD62T125■
150	FD62B150■		FD62T150■
175	FD62B175■		FD62T175■
200	FD62B200■		FD62T200■
225	FD62B225■		FD62T225■
250	FD62B250■		FD62T250■

### 3-Pole 600V AC, 500V DC<sup>③</sup>

Continuous Current Rating @ 40°C	Catalog Number	Frame Only Catalog Number	Trip Unit Only Catalog Number
70	FD63B070■	FD63F250	FD63T070■
80	FD63B080■		FD63T080■
90	FD63B090■		FD63T090■
100	FD63B100■		FD63T100■
110	FD63B110■		FD63T110■
125	FD63B125■		FD63T125■
150	FD63B150■		FD63T150■
175	FD63B175■		FD63T175■
200	FD63B200■		FD63T200■
225	FD63B225■		FD63T225■
250	FD63B250■		FD63T250■

## Interrupting Ratings

Breaker Type	RMS Symmetrical Amperes (KA)										
	UL 489 AIR (File E10848)						IEC 947-2 <sup>⑦</sup>				
	Volts AC (50/60Hz)			Volts DC		Volts AC (50/60Hz)					
	240	480	600	250	500 <sup>③</sup>	220/240	380/415	500			
	Icu	Ics	Icu	Ics	Icu	Ics	Icu	Ics			
FXD6-A, FD6-A	65	35	22	30 (2-P)	18 (3-P)	65	33	35	18	—	—
HFXD6, HFD6	100	65	25	30 (2-P)	25 (3-P)	100	50	65	33	—	—
HHFD6, HHFXD6	200	100	25	—	—	—	—	—	—	—	—
CFD6	200	200	100	30 (2-P)	50 (3-P)	—	—	—	—	—	—

## Instantaneous Adjustment Trip Range

Breaker Ampere Rating	Nominal Instantaneous Values							±20% Tolerance High
	±20% Tolerance Low	2	3	4	5	6	7	
70-90	600	640	690	730	770	810	850	900
100-110	700	770	840	920	990	1060	1140	1200
125-150	800	900	1000	1100	1200	1300	1400	1500
175-200	900	1060	1210	1370	1520	1780	1930	2000
225-250	1100	1300	1500	1700	1900	2100	2300	2500

Note: FD frame qualified to UL489 supplement SB "NAVAL". See page 7-138 for additional information.

## Ordering Information

### Complete Breaker Unassembled with Lugs

Prices of FD6, HFD6, and HHFD6 breakers includes frame, trip and both line and load lugs (TA1FD350A). When ordered by these catalog numbers, the customer will receive the frame, trip, and lugs separately packaged. For applications requiring different lugs, order individual items as needed.

### Complete Breaker Assembled with-out Lugs

Prices of FXD6, HFXD6, HHFXD6, and CFD6 includes frame with non-interchangeable trip unit installed only. Order required lugs separately. For line and load lugs (TA1FD350A) installed, add suffix "L" to catalog number (add 2 times list price of lugs for each pole).

50°C Applications see page 7-138.

400 Hz Applications see page 7-138.

## Lugs For 75°C Wire<sup>⑤</sup>

Catalog Number	Wire Range
TA1FD350A	#6–350 kcmil Cu #4–350 kcmil Al
TC1FD350	#6–350 kcmil Cu
Compression Lug	
CCF250	350 kcmil Cu/Al

## Enclosures

Type	Catalog Number
1	F6N1S(F)
3R	F6N3R
4-4X	FD6SS4
7-9	EC2
12	F6N12
Neutral <sup>⑥</sup>	N250

Modifications page 7-138  
Enclosures Section 6  
Accessories pages 7-98 and 7-142 to 7-147

■ Built to order. Allow 2–3 weeks for delivery.

- ① Type FXD6-A circuit breakers are UL Listed for reverse fed applications.
- ② 2-pole units are 3-pole width.
- ③ When wired as shown on page 7-4, this circuit breaker is UL listed and rated for use on 500V DC ungrounded UPS systems only.
- ④ Order neutral as separate item.
- ⑤ See Note: A, page 7-135.
- ⑥ HACR rated.
- ⑦ Only applicable to interchangeable trip unit types: FXD6A, HFXD6A.



# Molded Case Circuit Breakers

FD 250A Frame Sentron Series

Selection/Dimensions

Type HFD6, Type HFXD6<sup>②③④⑤</sup>

Black Label

Interchangeable Trip			
Continuous Current Rating @ 40°C	Complete Breaker Unassembled w/Lugs	Frame Only	Trip Unit Only
	Catalog Number	Catalog Number	Catalog Number

2-Pole 600V AC, 250V DC (3-Pole Width)

Current Rating	Complete Breaker Unassembled w/Lugs	Frame Only	Trip Unit Only
70	HFD62B070■	HFD62F250	FD62T070■
80	HFD62B080■		FD62T080■
90	HFD62B090■		FD62T090■
100	HFD62B100■		FD62T100■
110	HFD62B110■		FD62T110■
125	HFD62B125■		FD62T125■
150	HFD62B150■		FD62T150■
175	HFD62B175■		FD62T175■
200	HFD62B200■		FD62T200■
225	HFD62B225■		FD62T225■
250	HFD62B250■		FD62T250■

3-Pole 600V AC, 500V DC<sup>①</sup>

Current Rating	Complete Breaker Unassembled w/Lugs	Frame Only	Trip Unit Only
70	HFD63B070■	HFD63F250	FD63T070■
80	HFD63B080■		FD63T080■
90	HFD63B090■		FD63T090■
100	HFD63B100■		FD63T100■
110	HFD63B110■		FD63T110■
125	HFD63B125■		FD63T125■
150	HFD63B150■		FD63T150■
175	HFD63B175■		FD63T175■
200	HFD63B200■		FD63T200■
225	HFD63B225■		FD63T225■
250	HFD63B250■		FD63T250■

Type HHFD, HHFXD6<sup>②③⑤</sup>

3-Pole 600V AC, Extra High Interrupting

Current Rating	Complete Breaker Unassembled w/Lugs	Frame Only	Trip Unit Only
70	HHFD63B070■	HHFD63F250	FD63T070■
80	HHFD63B080■		FD63T080■
90	HHFD63B090■		FD63T090■
100	HHFD63B100■		FD63T100■
110	HHFD63B110■		FD63T110■
125	HHFD63B125■		FD63T125■
150	HHFD63B150■		FD63T150■
175	HHFD63B175■		FD63T175■
200	HHFD63B200■		FD63T200■
225	HHFD63B225■		FD63T225■
250	HHFD63B250■		FD63T250■

Type CFD6-A<sup>③⑤</sup>

Fuseless Current Limiting

Red Label

Non-Interchangeable Trip (Assembled Circuit Breaker without Lugs)	
Continuous Current Rating @ 40°C	3-Pole 600V AC/500V DC
	Catalog Number
70	CFD63B070■
80	CFD63B080■
90	CFD63B090■
100	CFD63B100■
110	CFD63B110■
125	CFD63B125■
150	CFD63B150■
175	CFD63B175■
200	CFD63B200■
225	CFD63B225■
250	CFD63B250■

■ Built to order. Allow 2-3 weeks for delivery.

① When wired as shown on page 7-4, this circuit breaker is UL listed and rated for use on 500V DC ungrounded UPS systems.

② For non-interchangeable trip 3-pole HFD6 type circuit breaker, change prefix identifier from HFD6 to HFXD6.

Price equals frame and trip prices combined, e.g. price of HFXD63B250 equals price of HFD63F250 plus price of FD63T250. Order lugs separately.

③ Type HFXD6, HHFXD6, CFD6 are UL Listed for reverse feed applications.

④ FXD6, ETI, CFD6, ETI — See page 7-122 for ordering information.

⑤ HACR rated.

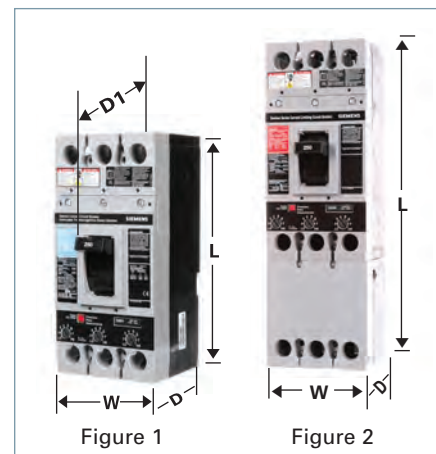

Dimensions (in inches)

Breaker Type	W	L	D	D1 (to handle)
Figure 1 FXD6-A, FD6-A, HFD6, HFXD6, HHFD6, FD6-ETI <sup>④</sup>	4.50	9.50	4	5.25
Figure 2 CFD6, CFD6-ETI <sup>④</sup>	4.50	14.25	4	5.25

Shipping Weights

Number of Poles	Number per Carton	Shipping Weight (lbs.)
<b>FD6-A, HFD6, HHFD6, FXD6-A Assembled Circuit Breaker (less connectors)</b>		
2	1	8.6
3	1	10
<b>FD6-A, HFD6, HHFD6 Frame Only</b>		
2	1	7.5
3	1	8.7
<b>FD6 Trip Unit Only</b>		
2	1	1.1
3	1	1.3
<b>CFD6 Assembled Circuit Breaker (less terminals)</b>		
3	1	16

7  
MOLDED CASE  
CIRCUIT BREAKERS

# Molded Case Circuit Breakers

## Accessories: for FD, FFC & FFF 250A Frames



### Shunt Trip Combinations

Control Voltage		1 Shunt Trip
AC	DC	Catalog Number
24		S17FD60
120		S01FD60
240		S03FD60
277		S15FD60▲
480		S04FD60
600		S06FD60▲
	12	S16FD60▲
	24	S07FD60
	48	S09FD60▲
	125	S11FD60
	250	S13FD60▲

### Undervoltage Trip Combinations

Control Voltage		1 Undervoltage Trip	1 Undervoltage Trip and 1 Auxiliary Switch
AC	DC	Catalog Number	Catalog Number
120		U01FD60	W01FD64
208		U02FD60▲	W02FD64▲
240		U03FD60	W03FD64▲
277		U16FD60▲	W16FD64▲
480		U06FD60▲	W06FD64▲
600		U08FD60▲	—
	24	U13FD60	W13FD64
	48	U14FD60▲	W14FD64▲
	125	U10FD60▲	W10FD64▲
	250	U12FD60▲	W12FD64▲

### Auxiliary Switch Combinations

Voltage		1 Auxiliary Switch	2 Auxiliary Switches
AC	DC	Catalog Number	Catalog Number
240		A01FD62	A02FD62
480		A01FD64	A02FD64
	12	A01FDLV	Gold Plated Contacts - for PLC use

### Alarm Switch Combinations

Maximum Voltage		1 Alarm Switch	1 Alarm Switch and 1 Auxiliary Switch
AC	DC	Catalog Number	Catalog Number
480	250	B00FD64	C01FD64

▲ Built to order. Allow 6-8 weeks for delivery.

ⓄAuxiliary switch application is for 480V AC maximum.

**Note:** Old F-frame accessories cannot be used in new Sentron line. Likewise, new FD-frame accessories cannot be used on old F-frame circuit breakers.

# Molded Case Circuit Breakers

JD 400A Frame Sentron Series

Selection

## Type JXD2-A<sup>④</sup>

240V AC, 2-Pole 250V DC Only

Blue Label

Non-Interchangeable Trip (Assembled Circuit Breaker without Lugs)		
Continuous Current Rating @ 40°C	2-Pole (3-Pole Width) Catalog Number	3-Pole Catalog Number
200	JXD22B200■	JXD23B200
225	JXD22B225■	JXD23B225
250	JXD22B250■	JXD23B250
300	JXD22B300	JXD23B300
350	JXD22B350■	JXD23B350
400	JXD22B400	JXD23B400

## Type JXD6-A<sup>①④</sup>

600V AC, 2-Pole 250V DC, 3-Pole 500V DC<sup>②</sup>

Blue Label

Non-Interchangeable Trip (Assembled Circuit Breaker without Lugs)		
Continuous Current Rating @ 40°C	2-Pole (3-Pole Width) Catalog Number	3-Pole Catalog Number
200	JXD62B200■	JXD63B200
225	JXD62B225■	JXD63B225
250	JXD62B250■	JXD63B250
300	JXD62B300	JXD63B300
350	JXD62B350■	JXD63B350
400	JXD62B400	JXD63B400

## Type JD6-A<sup>④</sup>

Blue Label

Interchangeable Trip			
Continuous Current Rating @ 40°C	Complete Breaker Unassembled w/Lugs	Frame Only	Trip Unit Only
	Catalog Number	Catalog Number	Catalog Number

2-Pole 600V AC, 250V DC (3-Pole Width)

200	JD62B200■	JD62F400	JD62T200■
225	JD62B225■		JD62T225■
250	JD62B250■		JD62T250■
300	JD62B300■		JD62T300■
350	JD62B350■		JD62T350■
400	JD62B400		JD62T400

3-Pole 600V AC, 500V DC<sup>②</sup>

200	JD63B200	JD63F400	JD63T200
225	JD63B225		JD63T225
250	JD63B250		JD63T250
300	JD63B300		JD63T300
350	JD63B350		JD63T350
400	JD63B400		JD63T400

## Interrupting Ratings

Breaker Type	RMS Symmetrical Amperes (KA)									
	UL 489 AIR (File E10848)					IEC 947-2 <sup>⑤</sup>				
	Volts AC (50/60Hz)			Volts DC		Volts AC (50/60Hz)				
	240	480	600	250	500 <sup>②</sup>	220/240	380/415	500	lcs	lcs
JXD2-A	65	—	—	30 (2-P)	—	—	—	—	—	—
JXD6-A, JD6-A	65	35	25	30 (2-P)	25 (3-P)	65	33	40	20	—
HJD6-A, HJXD6-A	100	65	35	30 (2-P)	35 (3-P)	100	50	65	33	—
HHJD6, HHJXD6	200	100	50	—	—	—	—	—	—	—
CJD6-A	200	150	100	30 (2-P)	50 (3-P)	—	—	—	—	—

## Instantaneous Adjustment Trip Range

Breaker Ampere Rating	Nominal Instantaneous Values							
	±20% Tolerance Low	2	3	4	5	6	7	±20% Tolerance High
200-300	1250	1430	1610	1790	1960	2140	2320	2500
350-400	2000	2290	2570	2860	3140	3430	3710	4000

■ Built to order. Allow 2-3 weeks for delivery.

①Type JXD2 and JXD6 circuit breakers are UL Listed for reverse feed applications.

②When wired as shown on page 7-4, this circuit breaker is UL listed and rated for use on 500V DC ungrounded UPS systems only.

③See Note: A, page 7-135.

④ HACR rated.

⑤ Only applicable to interchangeable trip unit types: JXD6-A, HJXD6-A.

Note: JD frame qualified to UL489 supplement B "NAVAL." See page 7-138 for additional information.

## Ordering Information

### Complete Breaker Unassembled with Lugs

Prices of JD6, HJD6, and HHJD6 breakers include frame, trip and both line and load lugs (TA2J6500). When ordered by these catalog numbers, the customer will receive the frame, trip, and lugs separately packaged. For applications requiring different lugs, order individual items as needed.

### Complete Breaker Assembled with Lugs

Prices of JXD6, HJXD6, HHJXD6, and CJD6 include frame with non-interchangeable trip unit installed only. Order required lugs separately. For line and load lugs (TA2J6500) installed, add suffix "L" to catalog number (add 2 times list price of lugs for each pole).

### 100% Rated (3-pole only)

Types JXD6 and HJXD6 breakers are available with 100% ratings. To order add suffix "H" to catalog number, and 10% to list price. ■ 100% rated JD breakers require the use of 90°C Cu cable sized at 75°C ampacity and lugs TC1J6600 or TC2J6500.

50°C Applications see page 7-138.

400Hz Applications see page 7-138.

## Lugs For 75°C Wire<sup>③</sup>

Catalog Number	Cables per Lug	Wire Range
TA2J6500	1, 2	#3/0-500 kcmil Cu #4/0-500 kcmil Al
TA1L6750	1	500-750 kcmil Al 500-600 kcmil Cu
TC1J6600	1	#3/0-600 kcmil Cu
TC2J6500	1, 2	#3/0-500 kcmil Cu
Compression Lug		
CCL600	1	500 kcmil Cu/Al

Modifications page 7-138

Enclosures Section 6

Accessories pages 7-102 and 7-142 to 7-147

# Molded Case Circuit Breakers

JD 400A Frame Sentron Series

Selection/Dimensions

Type HJD6-A, HJXD6-A<sup>②④⑥</sup>

Black Label

Interchangeable Trip			
Continuous Current Rating @ 40°C	Complete Breaker Unassembled w/Lugs	Frame Only	Trip Unit Only
	Catalog Number	Catalog Number	Catalog Number
<b>2-Pole 600V AC, 250V DC (3-Pole Width)</b>			
200	HJD62B200■	HJD62F400■	JD62T200■
225	HJD62B225■		JD62T225■
250	HJD62B250■		JD62T250■
300	HJD62B300■		JD62T300■
350	HJD62B350■		JD62T350■
400	HJD62B400■		JD62T400■

**3-Pole 600V AC, 500V DC<sup>①②⑤</sup>**

200	HJD63B200■	HJD63F400	JD63T200
225	HJD63B225■		JD63T225
250	HJD63B250■		JD63T250
300	HJD63B300■		JD63T300
350	HJD63B350■		JD63T350
400	HJD63B400■		JD63T400

Type HHJD6, HHJXD6<sup>②④⑥</sup>

Black Label

2-Pole 600V AC (3-Pole Width)			
200	HHJD62B200■	HHJD62F400■	JD62T200■
225	HHJD62B225■		JD62T225■
250	HHJD62B250■		JD62T250■
300	HHJD62B300■		JD62T300■
350	HHJD62B350■		JD62T350■
400	HHJD62B400■		JD62T400■

**3-Pole 600VAC**

200	HHJD63B200	HHJD63F400	JD63T200
225	HHJD63B225		JD63T225
250	HHJD63B250		JD63T250
300	HHJD63B300		JD63T300
350	HHJD63B350		JD63T350
400	HHJD63B400		JD63T400

Type CJD6-A<sup>⑤⑥</sup>

Fuseless Current Limiting

Red Label

Non-Interchangeable Trip (Assembled Circuit Breaker Without Lugs)		
Continuous Current Rating @ 40°C	2-Pole 600V AC/250V DC	3-Pole 600V AC/500V DC
	Catalog Number	Catalog Number
200	For 2-pole application use outside poles of 3-pole circuit breaker	CJD63B200■
225		CJD63B225■
250		CJD63B250■
300		CJD63B300■
350		CJD63B350■
400		CJD63B400■

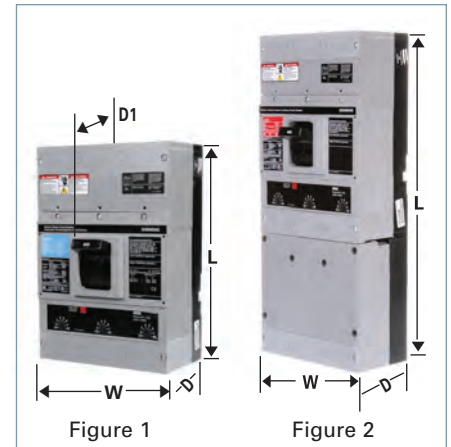

Dimensions (in inches)

Breaker Type	W	L	D	To Handle D1
Figure 1 JXD2-A, JXD6-A, JD6-A HJD6-A, HJXD6-A, HHJD6, HJD6, HJXD6, HHJXD6, JXD6-ETI <sup>®</sup> , SJD6, SHJD6	7.5	11	4	5.44
Figure 2 CJD6, CJD6-ETI <sup>®</sup> , SCJD6	7.5	17.86	4	5.44

Enclosures (Except SCJD6)

Type	Catalog Number
1	J6N1
3R	J6N3R
12	J6N12
4X	LD6SS4
7, 9 (200-250A)	EC4
7, 9 (300-400A)	EE
Neutral	W60992

Shipping Weights

Number of Poles	Number per Carton	Shipping Weight (lbs.)
<b>JXD2, JXD6, JD6, HJD6, HHJD6 Assembled Breaker (less terminals)</b>		
2	1	17.5
3	1	19.5
<b>JD6, HJD6, HHJD6 Frame Only</b>		
2	1	14
3	1	15.5
<b>JD6 Trip Unit Only</b>		
2	1	3.5
3	1	4
<b>CJD6 Complete Assembled Breaker (less terminals)</b>		
3	1	31.5

For inches / millimeters conversion, see Application Data section.

■ Built to order. Allow 2-3 weeks for delivery.

2-pole units available in 3-pole construction.

⑥ When wired as shown on page 7-4, this circuit breaker is UL listed and rated for use on 500V DC ungrounded UPS systems only.

③ For non-interchangeable 3-pole HJD6 or HHJD6 type circuit breaker change the prefix identifier to HJXD6 or HHJXD6. Price equals price of frame plus price of trip, e.g. price of HJXD63B400 equals price of HJD63F400 plus price of JD63T400. Order lugs separately.

③ JXD6-ETI, CJD6-ETI see page 7-122 for ordering information.

④ Type HJXD6, HHJXD6 Circuit Breakers are UL listed for reverse fed applications.

⑤ CE applies to non-interchangeable type HJXD6-A only.

⑥ HACR rated.

# Molded Case Circuit Breakers

SJD 400A Frame Digital Solid State Sentron Sensitrip IV Series

Selection

Type SJD6-B

Blue Label

Type SHJD6-B

Black Label

Current Limiting

Type SCJD6-B

Red Label

Max Current Rating	3-Pole, 600V AC		3-Pole, 600V AC		3-Pole, 600V AC	
	Catalog Number (Advanced trip unit) <sup>③</sup>	Catalog Number (Basic trip unit)	Catalog Number (Advanced trip unit) <sup>③</sup>	Catalog Number (Basic trip unit)	Catalog Number (Advanced trip unit) <sup>③</sup>	Catalog Number (Basic trip unit)
200	SJD6A200LI	SJD6B200LI	SHJD6A200LI	SHJD6B200LI	SCJD6A200LI	SCJD6B200LI
300	SJD6A300LI	SJD6B300LI	SHJD6A300LI	SHJD6B300LI	SCJD6A300LI	SCJD6B300LI
400	SJD6A400LI	SJD6B400LI	SHJD6A400LI	SHJD6B400LI	SCJD6A400LI	SCJD6B400LI
200	SJD6A200LIG	SJD6B200LIG	SHJD6A200LIG	SHJD6B200LIG	SCJD6A200LIG	SCJD6B200LIG
300	SJD6A300LIG	SJD6B300LIG	SHJD6A300LIG	SHJD6B300LIG	SCJD6A300LIG	SCJD6B300LIG
400	SJD6A400LIG	SJD6B400LIG	SHJD6A400LIG	SHJD6B400LIG	SCJD6A400LIG	SCJD6B400LIG
200	SJD6A200LSI	SJD6B200LSI	SHJD6A200LSI	SHJD6B200LSI	SCJD6A200LSI	SCJD6B200LSI
300	SJD6A300LSI	SJD6B300LSI	SHJD6A300LSI	SHJD6B300LSI	SCJD6A300LSI	SCJD6B300LSI
400	SJD6A400LSI	SJD6B400LSI	SHJD6A400LSI	SHJD6B400LSI	SCJD6A400LSI	SCJD6B400LSI
200	SJD6A200LSIG	SJD6B200LSIG	SHJD6A200LSIG	SHJD6B200LSIG	SCJD6A200LSIG	SCJD6B200LSIG
300	SJD6A300LSIG	SJD6B300LSIG	SHJD6A300LSIG	SHJD6B300LSIG	SCJD6A300LSIG	SCJD6B300LSIG
400	SJD6A400LSIG	SJD6B400LSIG	SHJD6A400LSIG	SHJD6B400LSIG	SCJD6A400LSIG	SCJD6B400LSIG

## SJD 400A Frame – 100% Rated<sup>②</sup>

Type SJD6-B

Blue Label

Type SHJD6-B

Black Label

Max Current Rating	3-Pole, 600V AC		3-Pole, 600V AC	
	Catalog Number (Advanced trip unit) <sup>③</sup>	Catalog Number (Basic trip unit)	Catalog Number (Advanced trip unit) <sup>③</sup>	Catalog Number (Basic trip unit)
200	SJD6A200LIH	SJD6B200LIH	SHJD6A200LIH	SHJD6B200LIH
300	SJD6A300LIH	SJD6B300LIH	SHJD6A300LIH	SHJD6B300LIH
400	SJD6A400LIH	SJD6B400LIH	SHJD6A400LIH	SHJD6B400LIH
200	SJD6A200LIGH	SJD6B200LIGH	SHJD6A200LIGH	SHJD6B200LIGH
300	SJD6A300LIGH	SJD6B300LIGH	SHJD6A300LIGH	SHJD6B300LIGH
400	SJD6A400LIGH	SJD6B400LIGH	SHJD6A400LIGH	SHJD6B400LIGH
200	SJD6A200LSIH	SJD6B200LSIH	SHJD6A200LSIH	SHJD6B200LSIH
300	SJD6A300LSIH	SJD6B300LSIH	SHJD6A300LSIH	SHJD6B300LSIH
400	SJD6A400LSIH	SJD6B400LSIH	SHJD6A400LSIH	SHJD6B400LSIH
200	SJD6A200LSIGH	SJD6B200LSIGH	SHJD6A200LSIGH	SHJD6B200LSIGH
300	SJD6A300LSIGH	SJD6B300LSIGH	SHJD6A300LSIGH	SHJD6B300LSIGH
400	SJD6A400LSIGH	SJD6B400LSIGH	SHJD6A400LSIGH	SHJD6B400LSIGH

### Ordering Information

Pricing information for all Digital Sentron Series SJD Frames is for complete breaker only - price required lugs as separate items - lugs are suitable for 75°C Wire.

**SJD6-B, SHJD6-B and SCJD6-B are acceptable for reverse connection application.**

### Shipping Weights

Breaker Type	Number per Carton	Shipping Weight (lbs)
SJD6-B	1	20
SHJD6-B	1	20
SCJD6-B	1	33

### Trip Unit Adjustable Functions

Suffix Letter Code	Trip Type	Cont Current Setting	Long Time Delay	Instantaneous Pick Up	Short Time Pick Up	Short Time Fixed Delay	Short Time I <sup>2</sup> t Delay	Ground Fault Pick Up	Ground Fault Delay
LI	LI	✓	✓	✓					
LIG	LIG	✓	✓	✓				✓	✓
LSI	LSI	✓	✓	✓	✓	✓	✓		
LSIG	LSIG	✓	✓	✓	✓	✓	✓	✓	✓

### Interrupting Ratings

Breaker Type	RMS Symmetrical kA UL 489 (File E10848)		
	240V AC	480V AC	600V AC
SJD6-B	65	35	25
SHJD6-B	100	65	35
SCJD6-B	200	150	100

### Neutral Transformers

Ampere Rating	Catalog Number
200	N02SJD
300	N03SJD
400	N04SJD

**Note:** "G" suffix in catalog number denotes circuit breaker for 3-phase, 3-wire systems.  
For 3-phase, 4-wire, order correct 4th wire (neutral) transformer as separate and additional item.

All breakers built to order. Allow 2-3 weeks for delivery.  
 ① For additional information, see **Note: A**, page 7-135.  
 ② Refer to the NEC for proper application of 100% rated devices.  
 ③ Advanced trip unit equipped with DAS / Maintenance Mode. Requires customer-supplied 24V external power supply, maintenance switch and light.

### Lugs for 75°C Wire<sup>①</sup>

Catalog Number	No. of cables per connector	Wire Range
TA2J6500	2	#3/0-500 kcmil Cu
	2	#4/0-500 kcmil Al
TA1L6750	1	500-750 kcmil Al
	1	500-600 kcmil Cu
TC1J6600	1	#3/0-600 kcmil Cu
TC2J6500	2	#3/0-500 kcmil Cu
TA2J630	2	#4-#3/0 Cu/Al
Compression Lug		
CCL600	1 (pc.)	#1/0-500 kcmil Cu/Al

Enclosures Section 6  
Accessories pages 7-102 and 7-142 to 7-147

# Molded Case Circuit Breakers

## Internal Accessories

## Selection

Accessories for:

JD 400A Frame  
LD 600A Frame  
LMD 800A Frame  
SJD 400A Frame  
SLD 600A Frame



## Shunt Trip Combinations

Control Voltage		1 Shunt Trip	1 Shunt Trip and 1 Auxiliary Switch
AC	DC	Catalog Number	Catalog Number
24		S17JLD6	—
48		S18JLD6▲	—
120		S01JLD6	S01JLD62A
240		S03JLD6	S03JLD62A
277		S15JLD6▲	S15JLD64A▲
480		S04JLD6	—
	12	S16JLD6▲	S16JLD62A▲
	24	S07JLD6	S07JLD62A
	48	S09JLD6▲	S09JLD62A
	125	S11JLD6	S11JLD62A▲
	250	S13JLD6▲	S13JLD62A▲

## Undervoltage Trip Combinations

Control Voltage		1 Undervoltage Trip	1 Undervoltage Trip and 1 Auxiliary Switch	1 Undervoltage Trip and 2 Auxiliary Switches
AC	DC	Catalog Number	Catalog Number	Catalog Number
120		U01JLD6	U01JLD62A	U01JLD62AA
208		U02JLD6▲	U02JLD62A▲	U02JLD62AA▲
240		U03JLD6	U03JLD62A▲	U03JLD62AA▲
480		U06JLD6	U06JLD64A▲	U06JLD64AA▲
	24	U13JLD6	U13JLD62A	U13JLD62AA
	48	U14JLD6▲	U14JLD62A▲	U14JLD62AA▲
	125	U10JLD6▲	U10JLD62A▲	U10JLD62AA▲
	250	U12JLD6▲	U12JLD62A▲	U12JLD62AA▲

## Auxiliary Switch Combinations

Maximum Voltage		1 Form C	2 Form C
AC	DC	Catalog Number	Catalog Number
480	250	A01JLD64	A02JLD64
—	12	A01JLDLV	A02JLDLV

## Alarm Switch Combinations

Maximum Voltage		1 Alarm Switch	1 Alarm Switch and 1 Auxiliary Switch	1 Alarm Switch and 2 Auxiliary Switches
AC	DC	Catalog Number	Catalog Number	Catalog Number
480	250	B01JLD64	A01JLD64B	A02JLD64B

## ETU Testing Unit

Breaker Type	Description	Catalog Number
SJD, SLD, SMD, SND, SPD	Power Stick	EPSP18V
	Spare cable for Power Stick	COMPCA

The EPSP18V Power Stick is a hand-held, battery-operated power supply that can be used for trip testing the Sensitrip IV electronic trip units. Requires two 9V batteries.

**Note:** Accessory modules can only be added to right side pole of solid state SJD and SLD frame circuit breakers. No accessories can be added if mechanical interlock is used. All accessories on this page are useable on superseded JD2, JJ6, JL6, HJ6, SJL, LJ6, LL6, HL6 and SLL circuit breakers.

▲ Built to order. Allow 6–8 weeks for delivery.

# Molded Case Circuit Breakers

LD 600A Frame Sentron Series

Selection

## Type LXD6-A<sup>①④</sup>

Blue Label

Non-Interchangeable Trip (Assembled Circuit Breaker without Lugs)				
Continuous Current Rating @ 40°C	2-Pole (3-Pole Width)		3-Pole	
	600V AC	250V DC	600V AC	500V DC
	Catalog Number		Catalog Number	
450	LXD62B450		LXD63B450	E
500	LXD62B500		LXD63B500	
600	LXD62B600		LXD63B600	

## Type LD6-A<sup>④</sup>

Blue Label

Interchangeable Trip			
Continuous Current Rating @ 40°C	Complete Breaker Unassembled w/Lugs	Frame Only	Trip Unit Only
	Catalog Number	Catalog Number	Catalog Number

### 2-Pole 600V AC, 250V DC (3-Pole Width)

Current Rating	Catalog Number	Frame Catalog Number	Trip Unit Catalog Number
250	LD62B250	LD62F600	JD62T250
300	LD62B300		JD62T300
350	LD62B350		JD62T350
400	LD62B400		JD62T400
450	LD62B450		LD62T450
500	LD62B500		LD62T500
600	LD62B600		LD62T600

### 3-Pole 600V AC, 500V DC<sup>②</sup>

Current Rating	Catalog Number	Frame Catalog Number	Trip Unit Catalog Number
250	LD63B250	LD63F600	JD63T250
300	LD63B300		JD63T300
350	LD63B350		JD63T350
400	LD63B400		JD63T400
450	LD63B450		LD63T450
500	LD63B500		LD63T500
600	LD63B600		LD63T600

## Interrupting Ratings

Breaker Type	RMS Symmetrical Amperes (KA)										
	UL 489 AIR (File E10848)						IEC 947-2 <sup>③</sup>				
	Volts AC (50/60Hz)			Volts DC			Volts AC (50/60Hz)				
	240	480	600	250	500 <sup>③</sup>	220/240	380/415	500	(Icu)	(Ics)	
LD6-A, LXD6-A	65	35	25	30 (2-P)	25 (3-P)	65	33	40	20	—	—
HLD6-A, HLXD6-A	100	65	35	30 (2-P)	35 (3-P)	100	50	65	33	—	—
HHL6, HHLXD6	200	100	50	—	—	—	—	—	—	—	—
CLD6-A	200	150	100	—	50 (3-P)	—	—	—	—	—	—

## Instantaneous Adjustment Trip Range

Breaker Ampere Rating	Nominal Instantaneous Values							
	±20% Tolerance Low							±20% Tolerance High
		2	3	4	5	6	7	
250-300	1250	1430	1610	1790	1960	2140	2320	2500
350-450	2000	2290	2570	2860	3140	3430	3710	4000
500-600	3000	3430	3800	4290	4710	5140	5570	6000

■ Built to order. Allow 2-3 weeks for delivery.

① Type LXD6A circuit breakers are UL Listed for reverse fed applications.

② When wired as shown on page 7-4, this circuit breaker is UL listed and rated for use on 500V DC ungrounded UPS systems only.

③ See Note: A, page 7-135.

④ HACR rated.

⑤ Only applicable to interchangeable trip unit types: LXD6, HLXD6.

Note: LD frame qualified to UL489 supplement SB "NAVAL". See page 7-138 for additional information.

Modifications page 7-138  
Enclosures Section 6  
Accessories pages 7-106 and 7-142 to 7-147

## Ordering Information

### Complete Breaker Unassembled with Lugs

Prices of LD6, HLD6, and HHL6 breakers include frame, trip, and both line and load lugs (TA2J6500). When ordered by these catalog numbers, the customer will receive the frame, trip and lugs separately packaged. For applications requiring different lugs, order individual items as needed.

### Complete Breaker Assembled with-out Lugs

Prices of LXD6, HLXD6, HHLXD6, and CLD6 include frame with non-interchangeable trip unit installed only. Order required lugs separately. For line and load lugs (TA2J6500) installed, add suffix "L" to catalog number (add 2 times list price of lugs for each pole).

### 100% Rated (3-pole only)

Types LXD6 and HLXD6 breakers are available with 100% ratings. To order add suffix "H" to catalog number, and 10% to list price. 100% rated LD breakers require the use of 90°C Cu cable sized at 75°C ampacity and lugs TC1J6600 or TC2J6500.

50°C Applications see page 7-138.

400Hz Applications see page 7-138.

## Shipping Weights

Number of Poles	Number per Carton	Shipping Weight (lbs.)
<b>LXD6, LD6, HLD6, HHL6 Assembled Breaker (less terminals)</b>		
2	1	17.5
3	1	19.5
<b>LD6, HLD6, HHL6 Frame Only</b>		
2	1	14
3	1	15.5
<b>LD6, HHL6 Trip Unit Only</b>		
2	1	3.5
3	1	4
<b>CLD6 Complete Assembled Breaker (less terminals)</b>		
3	1	31.5

## Lugs For 75°C Wire<sup>③</sup>

Catalog Number	Cables per Lug	Wire Range
TA2J6500	1, 2	#3/0 500 kcmil Cu #4/0 500 kcmil Al
TC2J6500	2	#3/0-500 kcmil Cu
TA1L6750	1	500-750 kcmil Al 500-600 kcmil Cu
TC1J6600	1	#3/0-600 kcmil Cu
<b>Compression Lug</b>		
CCL600	1	500 kcmil Cu/Al

# Molded Case Circuit Breakers

LD 600A Frame Sentron Series

Selection/Dimensions

Type HLD6-A, HLXD6-A<sup>②③④</sup>

Black Label

Interchangeable Trip			
Continuous Current Rating @ 40°C	Complete Breaker Unassembled w/Lugs	Frame Only	Trip Unit Only
	Catalog Number	Catalog Number	Catalog Number

2-Pole 600V AC, 250V DC (3-Pole Width)

Current Rating	Complete Breaker Unassembled w/Lugs	Frame Only	Trip Unit Only
250	HLD62B250■	HLD62F600■	JD62T250■
300	HLD62B300■		JD62T300■
350	HLD62B350■		JD62T350■
400	HLD62B400■		JD62T400■
450	HLD62B450■		LD62T450■
500	HLD62B500■		LD62T500■
600	HLD62B600■		LD62T600■

3-Pole 600V AC, 500V DC<sup>①⑤</sup>

Current Rating	Complete Breaker Unassembled w/Lugs	Frame Only	Trip Unit Only
250	HLD63B250■	HLD63F600■	JD63T250■
300	HLD63B300■		JD63T300■
350	HLD63B350■		JD63T350■
400	HLD63B400■		JD63T400■
450	HLD63B450■		LD63T450■
500	HLD63B500■		LD63T500■
600	HLD63B600■		LD63T600■

Type HHL6, HHLXD6<sup>②③④</sup>

Black Label

2-Pole 600V AC (3-Pole Width)

Current Rating	Complete Breaker Unassembled w/Lugs	Frame Only	Trip Unit Only
250	HHL62B250■	HHL62F600■	JD62T250■
300	HHL62B300■		JD62T300■
350	HHL62B350■		JD62T350■
400	HHL62B400■		JD62T400■
450	HHL62B450■		HHL62T450■
500	HHL62B500■		HHL62T500■
600	HHL62B600■		HHL62T600■

3-Pole 600V AC

Current Rating	Complete Breaker Unassembled w/Lugs	Frame Only	Trip Unit Only
250	HHL63B250■	HHL63F600■	JD63T250■
300	HHL63B300■		JD63T300■
350	HHL63B350■		JD63T350■
400	HHL63B400■		JD63T400■
450	HHL63B450■		HHL63T450■
500	HHL63B500■		HHL63T500■
600	HHL63B600■		HHL63T600■

Type CLD6-A<sup>③④</sup>

Fuseless Current Limiting

Red Label

Non-Interchangeable Trip (Assembled Circuit Breaker Without Lugs)

Continuous Current Rating @ 40°C	2-Pole 600V AC/250V DC	3-Pole 600V AC/500V DC
	Catalog Number	Catalog Number
450	For 2-pole application use outside poles of 3-pole circuit breaker	CLD63B450■
500		CLD63B500■
600		CLD63B600■

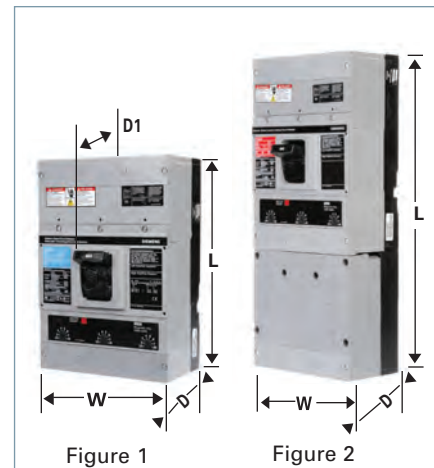

Dimensions (in inches)

Breaker Type	W	L	D	To Handle D1
Figure 1 LXD6-A, LD6-A HLD6-A HHL6, HHLXD6, LXD6-ETI <sup>⑥</sup> , SLD6, SHLD6	7.5	11	4	5.44
Figure 2 CLD6, CLD6-ETI <sup>⑥</sup> , SCLD6	7.5	17.86	4	5.44

Enclosures: (except SCLD6)

Type	Catalog Number
1	LD6N1
3R	LD6N3R
12	LD6N12
4X	LD6SS4
7,9	ED6
Neutral	W60993

For inches / millimeters conversion, see Application Data section.

■ Built to order. Allow 2-3 weeks for delivery.

① When wired as shown on page 7-4, this circuit breaker is UL listed and rated for use on 500V DC ungrounded UPS systems only.

② For complete assembled 3-pole HLD6 or HHL6 type circuit breaker change the prefix identifier HLD6 or HHL6 to HLXD6 or HHLXD6. Price is sum of frame and trip units prices, e.g. price of HLXD63B400 is the price of HLD63F600 plus the price of LD63T600. Order the terminal connectors separately.

③ Type HLXD6, HHLXD6, & CLD6 Circuit Breakers are UL Listed for reverse feed applications.  
④ LXD6-ETI, CLD6-ETI see page 7-122 for ordering information.  
⑤ CE Applies to non-interchangeable type HLXD only.  
⑥ HACR rated.



# Molded Case Circuit Breakers

SLD 600A Frame Digital Solid State Sentron Sensitrip IV Series

Selection

## Type SLD6-B

Blue Label

## Type SHLD6-B

Black Label

## Current Limiting

## Type SCLD6-B

Red Label

Max Current Rating	3-Pole, 600V AC		3-Pole, 600V AC		3-Pole, 600V AC	
	Catalog Number (Advanced trip unit) <sup>①</sup>	Catalog Number (Basic trip unit)	Catalog Number (Advanced trip unit) <sup>①</sup>	Catalog Number (Basic trip unit)	Catalog Number (Advanced trip unit) <sup>①</sup>	Catalog Number (Basic trip unit)
300	SLD6A300LI	SLD6B300LI	SHLD6A300LI	SHLD6B300LI	SCLD6A300LI	SCLD6B300LI
400	SLD6A400LI	SLD6B400LI	SHLD6A400LI	SHLD6B400LI	SCLD6A400LI	SCLD6B400LI
500	SLD6A500LI	SLD6B500LI	SHLD6A500LI	SHLD6B500LI	SCLD6A500LI	SCLD6B500LI
600	SLD6A600LI	SLD6B600LI	SHLD6A600LI	SHLD6B600LI	SCLD6A600LI	SCLD6B600LI
300	SLD6A300LIG	SLD6B300LIG	SHLD6A300LIG	SHLD6B300LIG	SCLD6A300LIG	SCLD6B300LIG
400	SLD6A400LIG	SLD6B400LIG	SHLD6A400LIG	SHLD6B400LIG	SCLD6A400LIG	SCLD6B400LIG
500	SLD6A500LIG	SLD6B500LIG	SHLD6A500LIG	SHLD6B500LIG	SCLD6A500LIG	SCLD6B500LIG
600	SLD6A600LIG	SLD6B600LIG	SHLD6A600LIG	SHLD6B600LIG	SCLD6A600LIG	SCLD6B600LIG
300	SLD6A300LSI	SLD6B300LSI	SHLD6A300LSI	SHLD6B300LSI	SCLD6A300LSI	SCLD6B300LSI
400	SLD6A400LSI	SLD6B400LSI	SHLD6A400LSI	SHLD6B400LSI	SCLD6A400LSI	SCLD6B400LSI
500	SLD6A500LSI	SLD6B500LSI	SHLD6A500LSI	SHLD6B500LSI	SCLD6A500LSI	SCLD6B500LSI
600	SLD6A600LSI	SLD6B600LSI	SHLD6A600LSI	SHLD6B600LSI	SCLD6A600LSI	SCLD6B600LSI
300	SLD6A300LSIG	SLD6B300LSIG	SHLD6A300LSIG	SHLD6B300LSIG	SCLD6A300LSIG	SCLD6B300LSIG
400	SLD6A400LSIG	SLD6B400LSIG	SHLD6A400LSIG	SHLD6B400LSIG	SCLD6A400LSIG	SCLD6B400LSIG
500	SLD6A500LSIG	SLD6B500LSIG	SHLD6A500LSIG	SHLD6B500LSIG	SCLD6A500LSIG	SCLD6B500LSIG
600	SLD6A600LSIG	SLD6B600LSIG	SHLD6A600LSIG	SHLD6B600LSIG	SCLD6A600LSIG	SCLD6B600LSIG

## Trip Unit Adjustable Functions

Suffix Letter Code	Trip Type	Cont Current Setting	Long Time Delay	Instantaneous Pick Up	Short Time Pick Up	Short Time Fixed Delay	Short Time I <sup>2</sup> t Delay	Ground Fault Pick Up	Ground Fault Delay
LI	LI	✓	✓	✓					
LIG	LIG	✓	✓	✓				✓	✓
LSI	LSI	✓	✓	✓	✓	✓	✓		
LSIG	LSIG	✓	✓	✓	✓	✓	✓	✓	✓

## Ordering Information

Pricing information for all Digital Sentron Series SLD Frames is for complete breaker only – price required lugs as separate items – lugs are suitable for 75°C Wire.

**SLD6, SHLD6 and SCLD6 are acceptable for reverse connection application.**

## Interrupting Ratings

Breaker Type	RMS Symmetrical kA UL 489 (File E10848)		
	240V AC	480V AC	600V AC
SLD6-B	65	35	25
SHLD6-B	100	65	35
SCLD6-B	200	150	100

## Neutral Transformers

Ampere Rating	Catalog Number
300	N03SJD
400	N04SJD
500	N05SLD
600	N06SLD

## Shipping Weights

Breaker Type	Number per Carton	Shipping Weight (lbs)
SLD6-B	1	20
SHLD6-B	1	20
SCLD6-B	1	33

Note: "G" suffix in catalog number denotes circuit breaker for 3-phase, 3-wire circuits.  
For 3-phase, 4-wire, order correct 4th wire (neutral) transformer as separate and additional item.

For ordering information and terminal connectors see page 7-103; for enclosures, see page 7-104.

**100% Rated** – Not available in SLD6 Frame.

All breakers built to order. Allow 2-3 weeks for delivery.

① Advanced trip unit equipped with DAS / Maintenance Mode. Requires customer-supplied 24V external power supply, maintenance switch and light.

# Molded Case Circuit Breakers

## Internal Accessories

## Selection

Accessories for:

JD 400A Frame  
LD 600A Frame  
LMD 800A Frame  
SJD 400A Frame  
SLD 600A Frame



S01JLD6

## Shunt Trip Combinations

Control Voltage		1 Shunt Trip	1 Shunt Trip and 1 Auxiliary Switch
AC	DC	Catalog Number	Catalog Number
24		S17JLD6	—
48		S18JLD6▲	—
120		S01JLD6	S01JLD62A
240		S03JLD6	S03JLD62A
277		S15JLD6▲	S15JLD64A▲
480		S04JLD6	—
	12	S16JLD6▲	S16JLD62A▲
	24	S07JLD6	S07JLD62A
	48	S09JLD6▲	S09JLD62A
	125	S11JLD6	S11JLD62A▲
	250	S13JLD6▲	S13JLD62A▲

## Undervoltage Trip Combinations

Control Voltage		1 Undervoltage Trip	1 Undervoltage Trip and 1 Auxiliary Switch	1 Undervoltage Trip and 2 Auxiliary Switches
AC	DC	Catalog Number	Catalog Number	Catalog Number
120		U01JLD6	U01JLD62A	U01JLD62AA
208		U02JLD6▲	U02JLD62A▲	U02JLD62AA▲
240		U03JLD6	U03JLD62A▲	U03JLD62AA▲
480		U06JLD6	U06JLD64A▲	U06JLD64AA▲
	24	U13JLD6	U13JLD62A	U13JLD62AA
	48	U14JLD6▲	U14JLD62A▲	U14JLD62AA▲
	125	U10JLD6▲	U10JLD62A▲	U10JLD62AA▲
	250	U12JLD6▲	U12JLD62A▲	U12JLD62AA▲

## Auxiliary Switch Combinations

Maximum Voltage		1 Form C	2 Form C
AC	DC	Catalog Number	Catalog Number
480	250	A01JLD64	A02JLD64
—	12	A01JLDLV	A02JLDLV

## Alarm Switch Combinations

Maximum Voltage		1 Alarm Switch	1 Alarm Switch and 1 Auxiliary Switch	1 Alarm Switch and 2 Auxiliary Switches
AC	DC	Catalog Number	Catalog Number	Catalog Number
480	250	B01JLD64	A01JLD64B	A02JLD64B

## ETU Testing Unit

Breaker Type	Description	Catalog Number
SJD, SLD, SMD, SND, SPD	Power Stick	EPSP18V
	Spare cable for Power Stick	COMPCA

The EPSP18V Power Stick is a hand-held, battery-operated power supply that can be used for trip testing the Sensitrip IV electronic trip units. Requires two 9V batteries.

**Note:** Accessory modules can only be added to right side pole of solid state SJD and SLD frame circuit breakers. No accessories can be added if mechanical interlock is used. All accessories on this page are useable on superseded JD2, JJ6, JL6, HJ6, SJL, LJ6, LL6, HL6 and SLL circuit breakers.

▲ Built to order. Allow 6–8 weeks for delivery.

# Molded Case Circuit Breakers

LMD 800A Frame Sentron Series

Selection

## Type LMXD6<sup>①④</sup>

Blue Label

Non-Interchangeable Trip (Assembled Circuit Breaker without Lugs)		
Continuous Current Rating @ 40°C	2-Pole (3-Pole Width) Catalog Number	3-Pole Catalog Number
500	—	LMXD63B500■
600	LMXD62B600■	LMXD63B600
700	LMXD62B700■	LMXD63B700
800	LMXD62B800	LMXD63B800

## Type LMD6<sup>④</sup>

Blue Label

Interchangeable Trip			
Continuous Current Rating @ 40°C	Complete Breaker Unassembled w/Lugs	Frame Only	Trip Unit Only
	Catalog Number	Catalog Number	Catalog Number
<b>2-Pole 600V AC, 250V DC (3-Pole Width)</b>			
500	LMD62B500■	LMD62F800■	LMD62T500■
600	LMD62B600■		LMD62T600■
700	LMD62B700■		LMD62T700■
800	LMD62B800■		LMD62T800■
<b>3-Pole 600V AC, 500V DC<sup>②</sup></b>			
500	LMD63B500■	LMD63F800	LMD63T500■
600	LMD63B600■		LMD63T600■
700	LMD63B700■		LMD63T700■
800	LMD63B800		LMD63T800

## Instantaneous Adjustment Trip Range

Ampere Rating	Nominal Instantaneous Values							
	Low +/- 20% Tolerance	2	3	4	5	6	7	High +/- 20% Tolerance
500-600	3000	3430	3860	4290	4710	5140	5570	6000
700-800	3200	3500	3700	4200	4700	6400	7300	8000

## Ordering Information

### Complete Breaker Unassembled with Lugs

Prices of LMD6 and HLMD6 breakers include frame, trip, and both line and load lugs (TA3K500). These catalog numbers include the frame, trip and lugs separately packaged. For applications requiring different lugs, order individual items as needed.

### Complete Breaker Assembled without Lugs

Prices of LMXD6 and HLMXD6 include frame with non-interchangeable trip unit installed only. Order required lugs separately. For line and load lugs (TA3K500) installed, add suffix "L" to catalog number (add 2 times list price of lugs for each pole).

**50°C Applications** see page 7-138.

**400Hz Applications** see page 7-138.

## Shipping Weights

Number of Poles	Number per Carton	Shipping Weight (lbs.)
<b>LMD6, HLMD6, LMXD6, HLMXD6 Complete Breaker (less terminals)</b>		
2	1	53
3	1	61.5
<b>LMD6, HLMD6 Frame Only</b>		
2	1	42.25
3	1	46
<b>LMD6, HLMD6 Trip Unit Only</b>		
2	1	4.5
3	1	6.5

## Lugs<sup>③</sup> for 75°C Wire

Catalog Number	Cables per Lug	Wire Range
TA2K500	1, 2	#1-500 kcmil Cu/Al
TA3K500	1-3	#1/0-500 kcmil Cu/Al
TA2N750	1, 2	500-750 kcmil Cu/Al

■ Built to order. Allow 2-3 weeks for delivery.

① LMXD6 circuit breakers are UL Listed for reverse connected applications.

② When wired as shown on page 7-4, this circuit breaker is UL listed and rated for use on 500VDC ungrounded UPS systems only.

③ See **Note: A**, page 7-135.

④ HACR rated.

Modifications page 7-138  
Enclosures Section 6

Accessories pages 7-109 and 7-142 to 7-147

# Molded Case Circuit Breakers

LMD 800A Frame Sentron Series

Selection/Dimensions

## Type HLMXD6<sup>①④</sup> Black Label

Non-Interchangeable Trip (Assembled Circuit Breaker Without Lugs)		
Continuous Current Rating @ 40°C	2-Pole 600V AC/250V DC	3-Pole 600V AC/500V DC
	Catalog Number	
500	For 2-pole application use outside poles of 3-pole circuit breaker	HLMXD63B500■
600		HLMXD63B600■
700		HLMXD63B700■
800		HLMXD63B800■

## Type HLMD6<sup>④</sup> Black Label

Interchangeable Trip			
Continuous Current Rating @ 40°C	Complete Breaker Unassembled	Frame Only	Trip Unit Only
	Catalog Number		

### 2-Pole 600V AC, 250V DC (3-Pole Width)

Continuous Current Rating @ 40°C	Complete Breaker Unassembled Catalog Number	Frame Only Catalog Number	Trip Unit Only Catalog Number
500	HLMD62B500■	HLMD62F800■	LMD62T500■
600	HLMD62B600■		LMD62T600■
700	HLMD62B700■		LMD62T700■
800	HLMD62B800■		LMD62T800■

### 3-Pole 600V AC, 500V DC<sup>③</sup>

Continuous Current Rating @ 40°C	Complete Breaker Unassembled Catalog Number	Frame Only Catalog Number	Trip Unit Only Catalog Number
500	HLMD63B500■	HLMD63F800■	LMD63T500■
600	HLMD63B600■		LMD63T600■
700	HLMD63B700■		LMD63T700■
800	HLMD63B800■		LMD63T800■

## Interrupting Ratings

Breaker Type	UL 489A IR				
	RMS Symmetrical Amperes (KA)				
	Volts AC			Volts DC	
	240	480	600	250	500
LMD6, LMXD6	65	50	25	30 (2-P)	25 (3-P)
HLMD6, HLMXD6	100	65	50	30 (2-P)	50 (3-P)

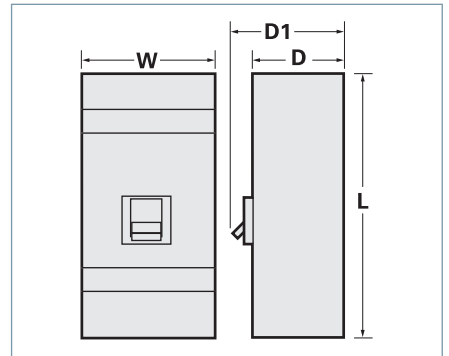

## Dimensions (in inches)

Breaker Type	W	L	D	D1
LMD6, LMXD6, HLMD6, HLMXD6, LMXD6-ETI <sup>②</sup>	7.5	16	4.5	5.93

## Enclosures

Type	Catalog Number
1	LMD1
3R	LMD3R
12	LMD12■
Neutral	W63623

For inches / millimeters conversion, see Application Data section.

■ Built to order. Allow 2-3 weeks for delivery.

① HLMXD6 circuit breakers are UL Listed for reverse connection applications.

② LMXD6-ETI, see page 7-122 for catalog information.

③ When wired as shown on page 7-4, this circuit breaker is UL listed and rated for use on 500VDC ungrounded UPS systems only.

④ HACR rated.

# Molded Case Circuit Breakers

Accessories for:

- JD 400A Frame
- LD 600A Frame
- LMD 800A Frame
- SJD 400A Frame
- SLD 600A Frame



## Shunt Trip Combinations

Control Voltage		1 Shunt Trip	1 Shunt Trip and 1 Auxiliary Switch
AC	DC	Catalog Number	Catalog Number
24		S17JLD6	—
48		S18JLD6▲	—
120		S01JLD6	S01JLD62A
240		S03JLD6	S03JLD62A
277		S15JLD6▲	S15JLD64A▲
480		S04JLD6	—
	12	S16JLD6▲	S16JLD62A▲
	24	S07JLD6	S07JLD62A
	48	S09JLD6▲	S09JLD62A
	125	S11JLD6	S11JLD62A▲
	250	S13JLD6▲	S13JLD62A▲

## Undervoltage Trip Combinations

Control Voltage		1 Undervoltage Trip	1 Undervoltage Trip and 1 Auxiliary Switch	1 Undervoltage Trip and 2 Auxiliary Switches
AC	DC	Catalog Number	Catalog Number	Catalog Number
120		U01JLD6	U01JLD62A	U01JLD62AA
208		U02JLD6▲	U02JLD62A▲	U02JLD62AA▲
240		U03JLD6	U03JLD62A▲	U03JLD62AA▲
480		U06JLD6	U06JLD64A▲	U06JLD64AA▲
	24	U13JLD6	U13JLD62A	U13JLD62AA
	48	U14JLD6▲	U14JLD62A▲	U14JLD62AA▲
	125	U10JLD6▲	U10JLD62A▲	U10JLD62AA▲
	250	U12JLD6▲	U12JLD62A▲	U12JLD62AA▲

## Auxiliary Switch Combinations

Maximum Voltage		1 Form C	2 Form C
AC	DC	Catalog Number	Catalog Number
480	250	A01JLD64	A02JLD64
—	12	A01JLDLV	A02JLDLV

## Alarm Switch Combinations

Maximum Voltage		1 Alarm Switch	1 Alarm Switch and 1 Auxiliary Switch	1 Alarm Switch and 2 Auxiliary Switches
AC	DC	Catalog Number	Catalog Number	Catalog Number
480	250	B01JLD64	A01JLD64B	A02JLD64B

## ETU Testing Unit

Breaker Type	Description	Catalog Number
SJD, SLD, SMD, SND, SPD	Power Stick	EPSP18V
	Spare cable for Power Stick	COMPCA

The EPSP18V Power Stick is a hand-held, battery-operated power supply that can be used for trip testing the Sensitrip IV electronic trip units. Requires two 9V batteries.

**Note:** Accessory modules can only be added to right side pole of solid state SJD and SLD frame circuit breakers. No accessories can be added if mechanical interlock is used. All accessories on this page are useable on superseded JD2, JJ6, JL6, HJ6, SJL, LJ6, LL6, HL6 and SLL circuit breakers.

▲ Built to order. Allow 6–8 weeks for delivery.

# Molded Case Circuit Breakers

MD 800A Frame Sentron Series

Selection

Type MXD6<sup>①⑥</sup>

Blue Label

Non-Interchangeable Trip (Assembled Circuit Breaker Without Lugs)		
Continuous Current Rating @ 40°C	2-Pole <sup>②</sup>	3-Pole
	Catalog Number	Catalog Number
600	MXD62B600■	MXD63B600
700	MXD62B700■	MXD63B700
800	MXD62B800■	MXD63B800

Type MD6<sup>⑥</sup>

Blue Label

Interchangeable Trip			
Continuous Current Rating @ 40°C	Complete Breaker Unassembled with Lugs	Frame Only	Trip Unit Only
	Catalog Number	Catalog Number	Catalog Number

2-Pole 600V AC, 250V DC<sup>②</sup>

Continuous Current Rating @ 40°C	Catalog Number	Frame Only Catalog Number	Trip Unit Only Catalog Number
500	MD62B500■	MD62F800■	MD62T500■
600	MD62B600■		MD62T600■
700	MD62B700■		MD62T700■
800	MD62B800■		MD62T800■

3-Pole 600V AC, 500V DC<sup>③</sup>

Continuous Current Rating @ 40°C	Catalog Number	Frame Only Catalog Number	Trip Unit Only Catalog Number
500	MD63B500	MD63F800	MD63T500
600	MD63B600		MD63T600
700	MD63B700		MD63T700
800	MD63B800		MD63T800

Lugs<sup>④</sup>

Catalog Number	Cables Per Lug	Lugs Per Kit	Wire Range
TA2K500	1-2	1	#1-500 kcmil Cu/Al
TA3K500	1-3	1	1/0-500 kcmil Cu/Al
TC2K500	1-2	1	#1-500 kcmil Cu
TC3K350	1-3	1	#1-350 kcmil Cu
Kits			
2TA2N8750 3TA2N8750	1-2	2 3	500-750 kcmil Cu/Al
2TA3N8750 3TA3N8750	1-3	2 3	500-750 kcmil Cu/Al
2TA4N8500 3TA4N8500	1-4	2 3	250-500 kcmil Cu/Al
2TA4P8500 3TA4P8500	1-4	2 3	250-500 kcmil Cu/Al

## Instantaneous Adjustment Trip Range

Ampere Rating	Nominal Instantaneous Values							
	Low +/- 20% Tolerance	2	3	4	5	6	7	High +/- 20% Tolerance
500	3000	3430	3860	4280	4710	5140	5570	6000
600-800	4000	4570	5140	5710	6280	6850	7420	8000

■ Built to order. Allow 2-3 weeks for delivery.

①MXD6 circuit breakers are UL Listed for reverse connection applications.

②2-pole units available in 3-pole width only.

③ When wired as shown on page 7-4, this circuit breaker is UL listed and rated for use on 500V DC ungrounded UPS systems.

④ See **Note: A**, page 7-135.

⑤ 80% rated breakers with the CE mark will also be marked in the 100% rated version.

⑥ HACR rated.

Note: MD frame qualified to UL489 supplement B "NAVAL". See page 7-138 for additional information.

## Ordering Information

## Complete Breaker Unassembled with Lugs

Pricing information for MD6 and HMD6 breakers includes frame, trip, and both line and load lugs (TA3K500). When ordered by these catalog numbers, the customer will receive the frame, trip and lugs separately packaged. For applications requiring different lugs, order individual items as needed.

## Complete Breaker Assembled without Lugs

Prices of MXD6, HMXD6 and CMD6 include frame with non-interchangeable trip units installed only. Order required lugs separately. For line and load lugs (TA3K500) installed, add suffix "L" to catalog number (add 2 times list price of lugs for each pole).

100% Rated<sup>③</sup> 3-Pole Only

Types MXD6, HMXD6 and CMD6 breakers are available with 100% ratings. To order add suffix "H" to catalog number, and 10% to list price. 100% rated MD breakers require the use of 90°C Cu cable sized at 75°C ampacity and lugs 3TA4P8500 or 3TA2N8750.

50°C Applications see page 7-138.

400Hz Applications see page 7-138.

## Shipping Weights

Number of Poles	Number per Carton	Shipping Weight (lbs.)
MD6, HMD6, HMXD6, CMD6 Complete Breaker Assembled (less lugs)		
2	1	53
3	1	61.5
MD6, HMD6 Frame Only		
2	1	42.25
3	1	46
MD6, HMD6 Trip Unit Only		
2	1	4.5
3	1	6.5
SMD6 Breaker		
3	1	61.5

## Enclosures

Type	Catalog Number
1	MND61
3R	MND63
12	MND612■
Neutral	W63623

Modifications page 7-138

Enclosures Section 6

Accessories pages 7-113 and 7-142 to 7-147

# Molded Case Circuit Breakers

MD 800A Frame Sentron Series

Selection/Dimensions

## Type HMXD6<sup>①⑤</sup>

**Black Label**

Non-Interchangeable Trip (Assembled Circuit Breaker Without Lugs)		
Continuous Current Rating @ 40°C	2-Pole 600V AC/250V DC	3-Pole 600V AC/500V DC
	Catalog Number	Catalog Number
600	For 2-pole application use outside poles of 3-pole circuit breaker	HMXD63B600■
700		HMXD63B700■
800		HMXD63B800

## Type HMD6<sup>⑤</sup>

**Black Label**

Interchangeable Trip			
Continuous Current Rating @ 40°C	Complete Breaker Unassembled w/Lugs	Frame Only	Trip Unit Only
	Catalog Number	Catalog Number	Catalog Number

### 2-Pole 600V AC, 250V DC<sup>②</sup>

500	HMD62B500■	HMD62F800■	MD62T500■
600	HMD62B600■		MD62T600■
700	HMD62B700■		MD62T700■
800	HMD62B800■		MD62T800■

### 3-Pole 600V AC, 500V DC<sup>④</sup>

500	HMD63B500	HMD63F800	MD63T500
600	HMD63B600		MD63T600
700	HMD63B700		MD63T700
800	HMD63B800		MD63T800

## Type CMD6<sup>①⑤</sup>

Fuseless Current Limiting

**Red Label**

Non-Interchangeable Trip (Assembled Circuit Breaker Without Lugs)		
Continuous Current Rating @ 40°C	2-Pole 600V AC/250V DC	3-Pole 600V AC/500V DC
	Catalog Number	Catalog Number
600	For 2-pole application use outside poles of 3-pole circuit breaker	CMD63B600■
700		CMD63B700■
800		CMD63B800

## Interrupting Ratings

Breaker Type	UL 489 AIR—File E10848					IEC 947-2 AIR <sup>⑥</sup>					
	RMS Symmetrical Amperes (KA)					Volts AC (50/60HZ)					
	Volts AC			Volts DC		220/240		380/415		500	
	240	480	600	250	500 <sup>④</sup>	(lcu)	(lcs)	(lcu)	(lcs)	(lcu)	(lcs)
MD6, MXD6	65	50	25	30 (2-P)	25 (3-P)	65	33	40	20	—	—
HMD6, HMXD6	100	65	50	30 (2-P)	50 (3-P)	100	50	65	33	—	—
CMD6	200	100	65	—	50 (3-P)	—	—	—	—	—	—

For inches / millimeters conversion, see Application Data section.

■ Built to order. Allow 2-3 weeks for delivery.

① HMXD6 and CMD circuit breakers are UL listed for reverse connection applications.

② 2-pole units available in 3-pole width only.

③ MXD6-ETI, CMD6-ETI see page 7-122 for catalog information.

④ When wired as shown on page 7-4, this circuit breaker is UL listed and rated for use on 500V DC ungrounded UPS systems only.

⑤ HACR rated.

⑥ Only applicable to interchangeable trip unit types: MXD6, HMXD6

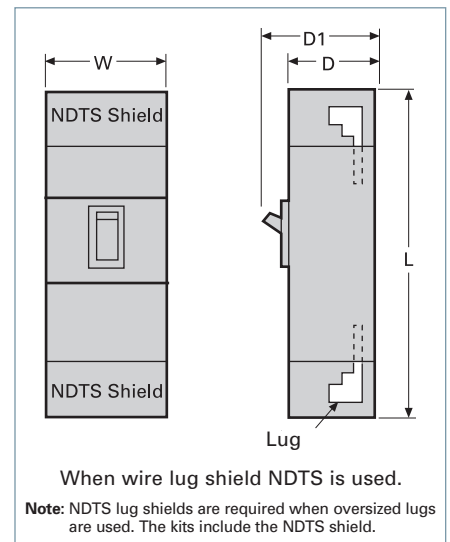

## Dimensions (in inches)

Breaker Type	W	L	D	(To Handle) D1
MD6, MXD6, HMD6, HMXD6, CMD6, MXD6-ETI, CMD6-ETI, SMD6-B, SHMD6-B, and SCMD6-B	9	16	6	8.25
with lug shields	9	24	6	8.25

MOLDED CASE CIRCUIT BREAKERS

# Molded Case Circuit Breakers

SMD 800A Frame Digital Solid State Sentron Sensitrip IV Series

Selection

Type SMD6

Blue Label

Type SHMD6-B

Black Label

Current Limiting

Type SCMD6-B

Red Label

Max Current Rating	3-Pole, 600V AC		3-Pole, 600V AC		3-Pole, 600V AC	
	Catalog Number (Advanced trip unit) <sup>③</sup>	Catalog Number (Basic trip unit)	Catalog Number (Advanced trip unit) <sup>③</sup>	Catalog Number (Basic trip unit)	Catalog Number (Advanced trip unit) <sup>③</sup>	Catalog Number (Basic trip unit)
600	SMD6A600LI	SMD6B600LI	SHMD6A600LI	SHMD6B600LI	SCMD6A600LI	SCMD6B600LI
700	SMD6A700LI	SMD6B700LI	SHMD6A700LI	SHMD6B700LI	SCMD6A700LI	SCMD6B700LI
800	SMD6A800LI	SMD6B800LI	SHMD6A800LI	SHMD6B800LI	SCMD6A800LI	SCMD6B800LI
600	SMD6A600LIG	SMD6B600LIG	SHMD6A600LIG	SHMD6B600LIG	SCMD6A600LIG	SCMD6B600LIG
700	SMD6A700LIG	SMD6B700LIG	SHMD6A700LIG	SHMD6B700LIG	SCMD6A700LIG	SCMD6B700LIG
800	SMD6A800LIG	SMD6B800LIG	SHMD6A800LIG	SHMD6B800LIG	SCMD6A800LIG	SCMD6B800LIG
600	SMD6A600LSI	SMD6B600LSI	SHMD6A600LSI	SHMD6B600LSI	SCMD6A600LSI	SCMD6B600LSI
700	SMD6A700LSI	SMD6B700LSI	SHMD6A700LSI	SHMD6B700LSI	SCMD6A700LSI	SCMD6B700LSI
800	SMD6A800LSI	SMD6B800LSI	SHMD6A800LSI	SHMD6B800LSI	SCMD6A800LSI	SCMD6B800LSI
600	SMD6A600LSIG	SMD6B600LSIG	SHMD6A600LSIG	SHMD6B600LSIG	SCMD6A600LSIG	SCMD6B600LSIG
700	SMD6A700LSIG	SMD6B700LSIG	SHMD6A700LSIG	SHMD6B700LSIG	SCMD6A700LSIG	SCMD6B700LSIG
800	SMD6A800LSIG	SMD6B800LSIG	SHMD6A800LSIG	SHMD6B800LSIG	SCMD6A800LSIG	SCMD6B800LSIG

## SMD 800A Frame – 100% Rated<sup>①</sup>

Type SMD6-B

Blue Label

Type SHMD6-B

Black Label

Current Limiting

Type SCMD6-B

Red Label

Max Current Rating	3-Pole, 600V AC		3-Pole, 600V AC		3-Pole, 600V AC	
	Catalog Number (Advanced trip unit) <sup>③</sup>	Catalog Number (Basic trip unit)	Catalog Number (Advanced trip unit) <sup>③</sup>	Catalog Number (Basic trip unit)	Catalog Number (Advanced trip unit) <sup>③</sup>	Catalog Number (Basic trip unit)
600	SMD6A600LIH	SMD6B600LIH	SHMD6A600LIH	SHMD6B600LIH	SCMD6A600LIH	SCMD6B600LIH
700	SMD6A700LIH	SMD6B700LIH	SHMD6A700LIH	SHMD6B700LIH	SCMD6A700LIH	SCMD6B700LIH
800	SMD6A800LIH	SMD6B800LIH	SHMD6A800LIH	SHMD6B800LIH	SCMD6A800LIH	SCMD6B800LIH
600	SMD6A600LIGH	SMD6B600LIGH	SHMD6A600LIGH	SHMD6B600LIGH	SCMD6A600LIGH	SCMD6B600LIGH
700	SMD6A700LIGH	SMD6B700LIGH	SHMD6A700LIGH	SHMD6B700LIGH	SCMD6A700LIGH	SCMD6B700LIGH
800	SMD6A800LIGH	SMD6B800LIGH	SHMD6A800LIGH	SHMD6B800LIGH	SCMD6A800LIGH	SCMD6B800LIGH
600	SMD6A600LSIH	SMD6B600LSIH	SHMD6A600LSIH	SHMD6B600LSIH	SCMD6A600LSIH	SCMD6B600LSIH
700	SMD6A700LSIH	SMD6B700LSIH	SHMD6A700LSIH	SHMD6B700LSIH	SCMD6A700LSIH	SCMD6B700LSIH
800	SMD6A800LSIH	SMD6B800LSIH	SHMD6A800LSIH	SHMD6B800LSIH	SCMD6A800LSIH	SCMD6B800LSIH
600	SMD6A600LSIGH	SMD6B600LSIGH	SHMD6A600LSIGH	SHMD6B600LSIGH	SCMD6A600LSIGH	SCMD6B600LSIGH
700	SMD6A700LSIGH	SMD6B700LSIGH	SHMD6A700LSIGH	SHMD6B700LSIGH	SCMD6A700LSIGH	SCMD6B700LSIGH
800	SMD6A800LSIGH	SMD6B800LSIGH	SHMD6A800LSIGH	SHMD6B800LSIGH	SCMD6A800LSIGH	SCMD6B800LSIGH

7 MOLDED CASE CIRCUIT BREAKERS

### Ordering Information

Pricing information for all Digital Sentron Series MD frames is for complete breaker only. Price requires lugs or lug kits as separate items. Lugs are suitable for 75°C wire or as noted. Connector wire ranges and cavities are established in conjunction with Table 6.1.4.2.1 of UL 489 standards. Choose actual connector for circuit breakers based on customer requirements.

### Recommended Terminal Connectors

Breaker Frame	Ampere Rating	Connector or Connector Kit
MD	500-600	TA2K500
MD	700-800	TA3K500

Types SMD6-B, SHMD6-B and SCMD6-B are acceptable for reverse connection applications

### Lugs for 75°C Wire<sup>②</sup>

Catalog Number	Cables per Lug	Wire Range	Each kit contains the following:
TA2K500	2	#1-500 kcmil Cu/Al	
TA3K500	3	#1-500 kcmil Cu/Al	
TC2K500	2	#1-500 kcmil Cu	
TC3K350	3	#1-350 kcmil Cu	3TA3N8750 - 3 connectors plus 1 NDTs end barrier
Kits (3 lugs/kit)			
3TA4N8500	4	250-500 kcmil Cu/Al	3TA2N8750 - 3 connectors plus 1 NDTs end barrier
3TA4P8500	4	250-500 kcmil Cu/Al	
3TA2N8750	2	500-750 kcmil Cu/Al	3TA3N8750 - 3 connectors plus 1 NDTs end barrier
3TA3N8750	3	500-750 kcmil Cu/Al	

### Trip Unit Adjustable Functions

Suffix Letter Code	Trip Type	Cont Current Setting	Long Time Delay	Instantaneous Pick Up	Short Time Pick Up	Short Time Delay	Ground Fault Pick Up	Ground Fault Delay
LI	LI	✓	✓	✓				
LIG	LIG	✓	✓	✓			✓	✓
LSI	LSI	✓	✓	✓	✓	✓		
LSIG	LSIG	✓	✓	✓	✓	✓	✓	✓

**Note:** "G" suffix in catalog number denotes circuit breaker for 3-phase, 3-wire circuits. For 3-phase, 4-wire, order correct 4th wire (neutral) transformer as separate and additional item.

All breakers built to order. Allow 2-3 weeks for delivery.

① Use 2-3TA4P8500 for 3-pole. These kits are rated for 90°C wire. 90°C Cu only cable must be used, and sized per 75°C ampacity.

② For additional information, see **Note: A**, page 7-135.

③ Advanced trip unit equipped with DAS / Maintenance Mode. Requires customer-supplied 24V external power supply, maintenance switch and light.

### Interrupting Ratings

Breaker Type	RMS Symmetrical kA UL 489 (File E10848)		
	240V AC	480V AC	600V AC
SMD6-B	65	50	25
SHMD6-B	100	65	50
SCMD6-B	200	100	65

### Neutral Transformers

Ampere Rating	Catalog Number
600	N06SMDA
700	N07SMDA
800	N08SMDA

Enclosures Section 6  
Accessories pages 7-113 and 7-142 to 7-147



# Molded Case Circuit Breakers

## Internal Accessories

## Selection

Accessories for:

MD/SMD 800A Frame  
ND/SND 1200A Frame  
PD/SPD 1600A Frame  
RD 2000A Frame



**S01MN6**

Accessory modules can mount in either left hand or right hand poles of all circuit breakers, including solid state. Exception: when mechanical interlock is used. Accessories cannot be mounted in left pole.

## Shunt Trip Combinations

Control Voltage		1 Shunt Trip	1 Shunt Trip and 1 Auxiliary Switch
AC	DC	Catalog Number	Catalog Number
120		S01MN6	S01MN64A
208		S02MN6▲	—
240		S03MN6	S03MN64A▲
277		S15MN6▲	S15MN64A▲
480		S04MN6▲	S04MN64A▲
600		S06MN6▲	—
	12	S16MN6▲	S16MN64A▲
	24	S07MN6	S07MN64A
	48	S09MN6▲	—
	125	S11MN6	S11MN64A▲
	250	S13MN6▲	S13MN64A▲

## Undervoltage Trip Combinations

Control Voltage		1 Undervoltage Trip	1 Undervoltage Trip and 1 Auxiliary Switch	1 Undervoltage Trip and 2 Auxiliary Switches
AC	DC	Catalog Number	Catalog Number	Catalog Number
120		U01MN6	U01MN64A	U01MN64AA
208		U02MN6▲	U02MN64A▲	U02MN64AA▲
240		U03MN6▲	U03MN64A▲	U03MN64AA▲
277		U15MN6▲	U15MN64A▲	U15MN64AA▲
480		U04MN6▲	U04MN64A▲	U04MN64AA▲
600		U06MN6▲	—	—
	24	U07MN6	U07MN64A	U07MN64AA
	48	U09MN6▲	U09MN64A▲	U09MN64AA▲
	125	U11MN6▲	U11MN64A▲	U11MN64AA▲
	250	U13MN6▲	U13MN64A▲	U13MN64AA▲

## Auxiliary Switch Combinations

Maximum Voltage		1 Form C	2 Form C
AC	DC	Catalog Number	Catalog Number
480	250	A01MN64	A02MN64
—	12	A01MNDLV▲	A02MNDLV▲

## Alarm Switch Combinations

Maximum Voltage		1 Alarm Switch	1 Alarm Switch and 1 Auxiliary Switch	1 Alarm Switch and 2 Auxiliary Switches
AC	DC	Catalog Number	Catalog Number	Catalog Number
480	250	B00MN64	A01MN64B	A02MN64B

## ETU Testing Unit

Breaker Type	Description	Catalog Number
SJD, SLD, SMD, SND, SPD	Power Stick	EPSP18V
	Spare cable for Power Stick	COMPCA

The EPSP18V Power Stick is a hand-held, battery-operated power supply that can be used for trip testing the Sensitrip IV electronic trip units. Requires two 9V batteries.

▲ Built to order. Allow 6–8 weeks for delivery.

# Molded Case Circuit Breakers

ND 1200A Frame Sentron Series

Selection

Type NXD6<sup>①③</sup>

Blue Label

## Non-Interchangeable Trip (Assembled Circuit Breaker Without Lugs)

Continuous Current Rating @ 40°C	2-Pole 600V AC/250V DC	3-Pole 600V AC/500V DC
	Catalog Number	Catalog Number
900	NXD62B900■	NXD63B900
1000	NXD62B100■	NXD63B100
1200	NXD62B120■	NXD63B120

Type ND6<sup>⑧</sup>

Blue Label

## Interchangeable Trip

Continuous Current Rating @ 40°C	Complete Breaker Unassembled with Lugs	Frame Only	Trip Unit Only
	Catalog Number	Catalog Number	Catalog Number

### 2-Pole 600V AC, 250V DC<sup>②</sup>

Continuous Current Rating @ 40°C	Complete Breaker Unassembled with Lugs	Frame Only	Trip Unit Only
800	ND62B800■	ND62F120	MD62T800■
900	ND62B900■		ND62T900■
1000	ND62B100■		ND62T100■
1200	ND62B120		ND62T120

### 3-Pole 600V AC, 500V DC<sup>③</sup>

Continuous Current Rating @ 40°C	Complete Breaker Unassembled with Lugs	Frame Only	Trip Unit Only
800	ND63B800	ND63F120	MD63T800
900	ND63B900		ND63T900
1000	ND63B100		ND63T100
1200	ND63B120		ND63T120

## Interrupting Ratings

Breaker Type	RMS Symmetrical Amperes (KA)										
	UL 489 A IR					IEC 947-2 <sup>④</sup>					
	Volts AC			Volts DC		Volts AC (50/60HZ)					
	240	480	600	250	500 <sup>⑤</sup>	220/240		380/415		500	
					(lcu)	(lcs)	(lcu)	(lcs)	(lcu)	(lcs)	
ND6, NXD6	65	50	25	30 (2-P)	25 (3-P)	65	33	40	20	—	—
HND6, HNXD6	100	65	50	30 (2-P)	50 (3-P)	100	50	65	33	—	—
CND6	200	100	65	—	50 (3-P)	—	—	—	—	—	—

## Instantaneous Adjustment Trip Range

Breaker Ampere Rating	Nominal Instantaneous Values							
	±20% Tolerance Low	2	3	4	5	6	7	±20% Tolerance High
	800	4000	4570	5140	5710	6280	6850	7420
900-1200	5000	5715	6430	7145	7860	8575	9290	10000

■ Built to order. Allow 2-3 weeks for delivery.

①NXD6 circuit breakers are UL listed for reverse connection applications.

②2-pole units available in 3-pole width only.

③When wired as shown on page 7-4, this circuit breaker is UL listed and rated for use on 500VDC ungrounded UPS systems only.

④Use 2 – 3TA4P8500 kits for 3-pole, or 2 – 2TA4P8500 kits for 2-pole. Rated for 90° C cable. Use for 100% rated breakers.

⑤Use 2 – 3TA4N8500 for 3-pole or 2 – 2TA4N8500 for 2-pole. Rated for 75°C cable.

⑥See **Note: A**, page 7-135.

⑦80% rated breakers with the CE mark will also be marked in the 100% rated version.

⑧HACR rated.

⑨ Only applicable to interchangeable trip unit types: NXD6, HNXD6.

**Note:** ND frame qualified to UL489 supplement B "NAVAL". See page 7-138 for additional information.

## Ordering Information

### Complete Breaker Unassembled with Lugs

Prices of ND6 and HND6 breakers include frame, trip, and both line and load lugs (3TA4N8500). These catalog numbers are the frame, trip and lugs separately packaged. For applications requiring different lugs, order individual items as needed.

### Complete Breaker Assembled without Lugs

Prices of NXD6, HNXD6, and CND6 include frame with non-interchangeable trip units installed only. Order required terminal connectors separately. For line and load lugs (3TA4N8500) installed, add suffix "L" to catalog number (add 2 times list price of lug kit).

### 100% Rated (3-Pole only)<sup>⑦</sup>

Types NXD6, HNXD6 and CND6 breakers are available with 100% ratings. To order, add suffix "H" to catalog number, and add 10% to list price. 100% rated ND breakers require 90°C Cu cable sized at 75°C ampacity and lug kit 3TA4P8500 or 3TA3N8750.

50°C Applications see page 7-138.

400Hz Applications see page 7-138.

## Lugs<sup>⑥</sup>

Catalog Number	Cables per Lug	Wire Range
TA2K500	2	#1-500 kcmil Cu/Al
TA3K500	3	#1-500 kcmil Cu/Al
TC2K500	2	#1-500 kcmil Cu
TC3K350	3	#1-350 kcmil Cu

### Kits (2 Kits required per breaker)

2TA4P8500 <sup>⑧</sup>	4	250-500 kcmil Cu/Al
3TA4P8500 <sup>⑧</sup>		
2TA4N8500 <sup>⑧</sup>	4	250-500 kcmil Cu/Al
3TA4N8500 <sup>⑧</sup>		
2TA2N8750	2	500-750 kcmil Cu/Al
3TA2N8750		
2TA3N8750	3	500-750 kcmil Cu/Al
3TA3N8750		

## Enclosures

Type	Catalog Number
1	MND61
3R	MND63
12	MND612■
Neutral	W63623

Modifications page 7-138

Enclosures Section 6

Accessories pages 7-117 and 7-142 to 7-147

# Molded Case Circuit Breakers

ND 1200A Frame Sentron Series

Selection/Dimensions

## Type HNXD6<sup>①④</sup>

**Black Label**

Non-Interchangeable Trip (Assembled Circuit Breaker Without Lugs)		
Continuous Current Rating @ 40°C	2-Pole	3-Pole
	Catalog Number	Catalog Number
900	For 2-pole application use outside poles of 3-pole circuit breaker	HNXD63B900
1000		HNXD63B100
1200		HNXD63B120

## Type HND6<sup>④</sup>

**Black Label**

Interchangeable Trip			
Continuous Current Rating @ 40°C	Complete Breaker Unassembled with Lugs	Frame Only	Trip Unit Only
	Catalog Number	Catalog Number	Catalog Number
800	For 2-pole application use outside poles of 3-pole circuit breaker	HND63F120	MD63T800
900			ND63T900
1000			ND63T100
1200			ND63T120

### 2-Pole 600V AC, 250V DC<sup>②</sup>

800	For 2-pole application use outside poles of 3-pole circuit breaker
900	
1000	
1200	

### 3-Pole 600V AC, 500V DC<sup>③</sup>

800	HND63B800	HND63F120	MD63T800
900	HND63B900		ND63T900
1000	HND63B100		ND63T100
1200	HND63B120		ND63T120

## Type CND6<sup>①④</sup>

Fuseless Current Limiting

**Red Label**

Non-Interchangeable Trip (Assembled Circuit Breaker)		
Continuous Current Rating @ 40°C	2-Pole	3-Pole
	Catalog Number	Catalog Number
900	For 2-pole application, use outside poles of 3-pole circuit breaker	CND63B900
1000		CND63B100
1200		CND63B120

## Shipping Weights

Number of Poles	Number per Carton	Shipping Weight (lbs.)
<b>ND6, HND6, NXD6, HNXD6, CND6 Assembled Breaker (less terminals)</b>		
2	1	53
3	1	61.5
<b>ND6, HND6 Frame Only</b>		
2	1	42.25
3	1	46
<b>ND6, HND6 Trip Unit Only</b>		
2	1	4.5
3	1	6.5

For inches / millimeters conversion, see Application Data section.

■ Built to order. Allow 2-3 weeks for delivery.

① HNXD6 and CND6 circuit breakers are UL Listed for reverse connection applications.

② 2-pole units available in 3-pole width only.

③ When wired as shown on page 7-4, this circuit breaker is UL listed and rated for use on 500V DC ungrounded UPS systems only.

④ HACR rated.



NXD63B120

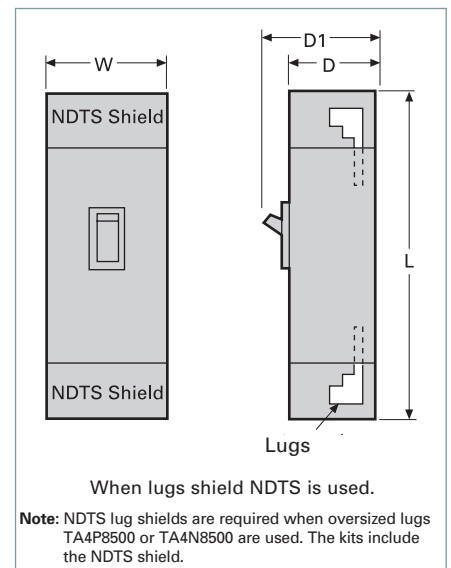

## Dimensions (in inches)

Breaker Type	W	L	D	D1
ND6, NXD6, HND6, HNXD6, CND6, SND6-B, SHND6-B, and SCND6-B	9	16	6	8.25
with NDTS lug shield	9	24	6	8.25

MOLDED CASE CIRCUIT BREAKERS

# Molded Case Circuit Breakers

SND 1200A Frame Digital Solid State Sentron Sensitrip IV Series<sup>②</sup>

Selection

Type SND6-B

Blue Label

Type SHND6-B

Black Label

Current Limiting

Type SCND6-B

Red Label

Max Current Rating	3-Pole, 600V AC		3-Pole, 600V AC		3-Pole, 600V AC	
	Catalog Number (Advanced trip unit) <sup>③</sup>	Catalog Number (Basic trip unit)	Catalog Number (Advanced trip unit) <sup>③</sup>	Catalog Number (Basic trip unit)	Catalog Number (Advanced trip unit) <sup>③</sup>	Catalog Number (Basic trip unit)
800	SND6A800LI	SND6B800LI	SHND6A800LI	SHND6B800LI	SCND6A800LI	SCND6B800LI
1000	SND6A100LI	SND6B100LI	SHND6A100LI	SHND6B100LI	SCND6A100LI	SCND6B100LI
1200	SND6A120LI	SND6B120LI	SHND6A120LI	SHND6B120LI	SCND6A120LI	SCND6B120LI
800	SND6A800LIG	SND6B800LIG	SHND6A800LIG	SHND6B800LIG	SCND6A800LIG	SCND6B800LIG
1000	SND6A100LIG	SND6B100LIG	SHND6A100LIG	SHND6B100LIG	SCND6A100LIG	SCND6B100LIG
1200	SND6A120LIG	SND6B120LIG	SHND6A120LIG	SHND6B120LIG	SCND6A120LIG	SCND6B120LIG
800	SND6A800LSI	SND6B800LSI	SHND6A800LSI	SHND6B800LSI	SCND6A800LSI	SCND6B800LSI
1000	SND6A100LSI	SND6B100LSI	SHND6A100LSI	SHND6B100LSI	SCND6A100LSI	SCND6B100LSI
1200	SND6A120LSI	SND6B120LSI	SHND6A120LSI	SHND6B120LSI	SCND6A120LSI	SCND6B120LSI
800	SND6A800LSIG	SND6B800LSIG	SHND6A800LSIG	SHND6B800LSIG	SCND6A800LSIG	SCND6B800LSIG
1000	SND6A100LSIG	SND6B100LSIG	SHND6A100LSIG	SHND6B100LSIG	SCND6A100LSIG	SCND6B100LSIG
1200	SND6A120LSIG	SND6B120LSIG	SHND6A120LSIG	SHND6B120LSIG	SCND6A120LSIG	SCND6B120LSIG

## SND 1200A Frame – 100% Rated<sup>①</sup>

Type SND6-B

Blue Label

Type SHND6-B

Black Label

Current Limiting

Type SCND6-B

Red Label

Max Current Rating	3-Pole, 600V AC		3-Pole, 600V AC		3-Pole, 600V AC	
	Catalog Number (Advanced trip unit) <sup>③</sup>	Catalog Number (Basic trip unit)	Catalog Number (Advanced trip unit) <sup>③</sup>	Catalog Number (Basic trip unit)	Catalog Number (Advanced trip unit) <sup>③</sup>	Catalog Number (Basic trip unit)
800	SND6A800LIH	SND6B800LIH	SHND6A800LIH	SHND6B800LIH	SCND6A800LIH	SCND6B800LIH
1000	SND6A100LIH	SND6B100LIH	SHND6A100LIH	SHND6B100LIH	SCND6A100LIH	SCND6B100LIH
1200	SND6A120LIH	SND6B120LIH	SHND6A120LIH	SHND6B120LIH	SCND6A120LIH	SCND6B120LIH
800	SND6A800LIGH	SND6B800LIGH	SHND6A800LIGH	SHND6B800LIGH	SCND6A800LIGH	SCND6B800LIGH
1000	SND6A100LIGH	SND6B100LIGH	SHND6A100LIGH	SHND6B100LIGH	SCND6A100LIGH	SCND6B100LIGH
1200	SND6A120LIGH	SND6B120LIGH	SHND6A120LIGH	SHND6B120LIGH	SCND6A120LIGH	SCND6B120LIGH
800	SND6A800LSIH	SND6B800LSIH	SHND6A800LSIH	SHND6B800LSIH	SCND6A800LSIH	SCND6B800LSIH
1000	SND6A100LSIH	SND6B100LSIH	SHND6A100LSIH	SHND6B100LSIH	SCND6A100LSIH	SCND6B100LSIH
1200	SND6A120LSIH	SND6B120LSIH	SHND6A120LSIH	SHND6B120LSIH	SCND6A120LSIH	SCND6B120LSIH
800	SND6A800LSIGH	SND6B800LSIGH	SHND6A800LSIGH	SHND6B800LSIGH	SCND6A800LSIGH	SCND6B800LSIGH
1000	SND6A100LSIGH	SND6B100LSIGH	SHND6A100LSIGH	SHND6B100LSIGH	SCND6A100LSIGH	SCND6B100LSIGH
1200	SND6A120LSIGH	SND6B120LSIGH	SHND6A120LSIGH	SHND6B120LSIGH	SCND6A120LSIGH	SCND6B120LSIGH

## Trip Unit Adjustable Functions

Suffix Letter Code	Trip Type	Cont Current Setting	Long Time Delay	Instantaneous Pick Up	Short Time Pick Up	Short Time Fixed Pick Up	Short Time I <sup>2</sup> t Delay	Ground Fault Pick Up	Ground Fault Delay
LI	LI	✓	✓	✓					
LIG	LIG	✓	✓	✓				✓	✓
LSI	LSI	✓	✓	✓	✓	✓	✓		
LSIG	LSIG	✓	✓	✓	✓	✓	✓	✓	✓

## Interrupting Ratings

Breaker Type	RMS Symmetrical kA UL 489 (File E10848)		
	240V AC	480V AC	600V AC
SND6-B	65	50	25
SHND6-B	100	65	50
SCND6-B	200	100	65

## Neutral Transformers

Ampere Rating	Catalog Number
800	N08SMDA
1000	N10SNDA
1200	N12SNDA

For inches / millimeters conversion, see Application Data section.

For ordering information and terminal connectors, and enclosures, see page 7-114.

**Note:** "G" suffix in catalog number denotes circuit breaker for 3-phase, 3-wire circuits.  
For 3-phase, 4-wire, order correct 4th wire (neutral) transformer as separate and additional item.

All breakers built to order. Allow 2–3 weeks for delivery.

① Use 2-3TA4P8500 for 3-pole. These kits are rated for 90°C wire. 90°C Cu only cable must be used, and sized per 75°C ampacity.

② SND6, SHND6 and SCND6 circuit breakers are UL Listed for reverse connection applications.

③ Advanced trip unit equipped with DAS / Maintenance Mode. Requires customer-supplied 24V external power supply, maintenance switch and light.

# Molded Case Circuit Breakers

## Internal Accessories

## Selection

Accessories for:

MD/SMD 800A Frame  
ND/SND 1200A Frame  
PD/SPD 1600A Frame  
RD 2000A Frame



S01MN6

Accessory modules can mount in either left hand or right hand poles of all circuit breakers, including solid state. Exception: when mechanical interlock is used. Accessories cannot be mounted in left pole.

## Shunt Trip Combinations

Control Voltage		1 Shunt Trip	1 Shunt Trip and 1 Auxiliary Switch
AC	DC	Catalog Number	Catalog Number
120		S01MN6	S01MN64A
208		S02MN6▲	—
240		S03MN6	S03MN64A▲
277		S15MN6▲	S15MN64A▲
480		S04MN6▲	S04MN64A▲
600		S06MN6▲	—
	12	S16MN6▲	S16MN64A▲
	24	S07MN6	S07MN64A
	48	S09MN6▲	—
	125	S11MN6	S11MN64A▲
	250	S13MN6▲	S13MN64A▲

## Undervoltage Trip Combinations

Control Voltage		1 Undervoltage Trip	1 Undervoltage Trip and 1 Auxiliary Switch	1 Undervoltage Trip and 2 Auxiliary Switches
AC	DC	Catalog Number	Catalog Number	Catalog Number
120		U01MN6	U01MN64A	U01MN64AA
208		U02MN6▲	U02MN64A▲	U02MN64AA▲
240		U03MN6▲	U03MN64A▲	U03MN64AA▲
277		U15MN6▲	U15MN64A▲	U15MN64AA▲
480		U04MN6▲	U04MN64A▲	U04MN64AA▲
600		U06MN6▲	—	—
	24	U07MN6	U07MN64A	U07MN64AA
	48	U09MN6▲	U09MN64A▲	U09MN64AA▲
	125	U11MN6▲	U11MN64A▲	U11MN64AA▲
	250	U13MN6▲	U13MN64A▲	U13MN64AA▲

## Auxiliary Switch Combinations

Maximum Voltage		1 Form C	2 Form C
AC	DC	Catalog Number	Catalog Number
480	250	A01MN64	A02MN64
—	12	A01MNDLV▲	A02MNDLV▲

## Alarm Switch Combinations

Maximum Voltage		1 Alarm Switch	1 Alarm Switch and 1 Auxiliary Switch	1 Alarm Switch and 2 Auxiliary Switches
AC	DC	Catalog Number	Catalog Number	Catalog Number
480	250	B00MN64	A01MN64B	A02MN64B

## ETU Testing Unit

Breaker Type	Description	Catalog Number
SJD, SLD, SMD, SND, SPD	Power Stick	EPSP18V
	Spare cable for Power Stick	COMPCA

The EPSP18V Power Stick is a hand-held, battery-operated power supply that can be used for trip testing the Sensitrip IV electronic trip units. Requires two 9V batteries.

▲ Built to order. Allow 6–8 weeks for delivery.

# Molded Case Circuit Breakers

PD 1600A Frame Sentron Series

Selection

## Type PXD6<sup>2</sup> Non-Interchangeable Trip<sup>5</sup>

3-Pole 600V AC, 250-500V DC<sup>1</sup>

Blue Label

Continuous Current Rating @ 40°C	Complete Breaker Assembled (Frame/Trip Unit Only)	Mounting Assembly	Lugs (6 required)
	Catalog Number	Catalog Number	Catalog Number
1200	PXD63B120■	MB9301	TA5P600
1400	PXD63B140■	-or-	
1600	PXD63B160	MBR9302	

## Type PD6 Interchangeable Trip<sup>5</sup>

3-Pole 600V AC, 250-500V DC<sup>1</sup>

Blue Label

Continuous Current Rating @ 40°C	Complete Breaker Unassembled	Frame Only	Trip Unit Only	Mounting Assembly	Lugs (6 required)
	Catalog Number	Catalog Number	Catalog Number	Catalog Number	Catalog Number
1200	PD63B120■	PD63F160	PD63T120■	MB9301	TA5P600
1400	PD63B140		PD63T140	-or-	
1600	PD63B160		PD63T160	MBR9302	

## Type HPXD6<sup>2</sup> Non-Interchangeable Trip<sup>5</sup>

3-Pole 600V AC, 250-500V DC<sup>1</sup>

Blue Label

Continuous Current Rating @ 40°C	Complete Breaker Assembled (Frame/Trip Unit Only)	
	Catalog Number	
1200	HPXD63B120■	
1400	HPXD63B140■	
1600	HPXD63B160	

## Type HPD6 Interchangeable Trip<sup>5</sup>

3-Pole 600V AC, 250-500V DC<sup>1</sup>

Black Label

Continuous Current Rating @ 40°C	Complete Breaker Unassembled	Frame Only	Trip Unit Only	Mounting Assembly	Lugs (6 required)
	Catalog Number	Catalog Number	Catalog Number	Catalog Number	Catalog Number
1200	HPD63B120■	HPD63F160	PD63T120■	MB9301	TA5P600
1400	HPD63B140		PD63T140	-or-	
1600	HPD63B160		PD63T160	MBR9302	

## Type CPD6 Non-Interchangeable Trip<sup>5</sup>

Fuseless Current Limiting

3-Pole 600V AC, 250-500V DC<sup>1</sup>

Red Label

Continuous Current Rating @ 40°C	Complete Breaker Assembled (Frame/Trip Unit Only)	
	Catalog Number	
1200	CPD63B120■	
1400	CPD63B140■	
1600	CPD63B160■	

## Interrupting Ratings

Breaker Type	UL 489 A IR				
	RMS Symmetrical KA				
	Volts AC			Volts DC <sup>3</sup>	
	240	480	600	250	500
PD6, PXD6	65	50	25	30 (2P)	25 (3P)
HPD6, HPXD6	100	65	50	30 (2P)	50 (3P)
CPD6	200	100	65	30 (2P)	50 (3P)

■ Built to order. Allow 2-3 weeks for delivery.

▲ Built to order. Allow 6-8 weeks for delivery.

① Use two outside poles of a 3-pole circuit breaker for 250V

② When wired as shown on page 7-4, this circuit breaker is

UL listed and rated for use on 500V DC ungrounded UPS systems only.

③ PXD6, HPXD6 and CPD6 type circuit breakers are UL Listed for reverse feed applications.

④ For additional information See **Note: A**, page 7-135.

## Ordering Instructions

### Complete Breaker Unassembled with Lugs

Prices of PD6, HPD6, RD6, and HRD6 type breakers include frame, trip, mounting base (MB9301), and both line and load lugs (PD Frame – TA5P600, RD Frame – TC5R600). When ordered by these catalog numbers, the customer will receive the frame, trip, mounting assembly and lugs separately packaged. For applications requiring different mounting base or lugs, order individual items as needed.

### Complete Breaker Assembled without Lugs

Prices of PXD6, HPXD6, RXD6, HRXD6 and CPD6 type breakers include frame with non-interchangeable trip unit installed only. Order required mounting base and lugs separately.

### 100% Rated (3-Pole only)

Types PXD6, HPXD6 breakers are available with 100% ratings. To order add suffix "H" to catalog number, and 10% to list price. 100% PD breakers require 90° C cable sized at 75° C ampacity and TC5R600 lugs. RD 2000A Frames not available with 100% ratings.

50°C Applications see page 7-138.

400HZ Applications see page 7-138.

## Lugs (6 required per breaker)<sup>4</sup>

Catalog Number	No of Cables per Connector	Wire Range
TA5P600	1-5	300-600 kcmil Cu/Al
TC5R600	1-5	300-600 kcmil Cu only
TA4P750▲	1-4	600-750 kcmil Cu/Al
TA6R600	1-6	300-600 kcmil Cu/Al

④ HACR rated.

**Note:** PD frame qualified to UL489 supplement B "NAVAL". See page 7-138 for additional information.

# Molded Case Circuit Breakers

SPD 1600A Frame Digital Solid State Sentron Sensitrip IV Series

Selection/Dimensions

## Type SPD6-B

Blue Label

## Type SHPD6-B

Black Label

Max Current Rating	3-Pole, 600V AC		3-Pole, 600V AC	
	Catalog Number (Advanced trip unit) <sup>③</sup>	Catalog Number (Basic trip unit)	Catalog Number (Advanced trip unit) <sup>③</sup>	Catalog Number (Basic trip unit)
1400	SPD6A140LI	SPD6B140LI	SHPD6A140LI	SHPD6B140LI
1600	SPD6A160LI	SPD6B160LI	SHPD6A160LI	SHPD6B160LI
1400	SPD6A140LIG	SPD6B140LIG	SHPD6A140LIG	SHPD6B140LIG
1600	SPD6A160LIG	SPD6B160LIG	SHPD6A160LIG	SHPD6B160LIG
1400	SPD6A140LSI	SPD6B140LSI	SHPD6A140LSI	SHPD6B140LSI
1600	SPD6A160LSI	SPD6B160LSI	SHPD6A160LSI	SHPD6B160LSI
1400	SPD6A140LSIG	SPD6B140LSIG	SHPD6A140LSIG	SHPD6B140LSIG
1600	SPD6A160LSIG	SPD6B160LSIG	SHPD6A160LSIG	SHPD6B160LSIG

## Ordering Information

Pricing information for all Digital Sentron Series PD frame unit is for breaker only. Price required mounting block assembly and necessary terminal connectors as separate items.

**SPD6-B and SHPD6-B are acceptable for reverse connection applications.**

## Lugs<sup>①</sup>

Catalog Number	No. of cables per connector	Wire Range
TA5P600	1-5 pcs.	300-600 kcmil Cu/Al
TC5R600	1-5 pcs.	300-600 kcmil Cu Only
TA6R600	1-6 pcs.	300-600 kcmil Cu/Al

## Neutral Transformers

Ampere Rating	Catalog Number
1400	N14SPD
1600	N16SPD

## Enclosure

Type	Catalog Number
1	PRD6N1

## Trip Unit Adjustable Functions

Suffix Letter Code	Trip Type	Cont Current Setting	Long Time Delay	Instantaneous Pick Up	Short Time Pick Up	Short Time Fixed Delay	Short Time I <sup>2</sup> t Delay	Ground Fault Pick Up	Ground Fault Delay
LI	LI	✓	✓	✓					
LIG	LIG	✓	✓	✓				✓	✓
LSI	LSI	✓	✓	✓	✓	✓	✓		
LSIG	LSIG	✓	✓	✓	✓	✓	✓	✓	✓

## Interrupting Ratings

Breaker Type	RMS Symmetrical kA UL 489		
	240V AC	480V AC	600V AC
SPD6-B	65	50	25
SHPD6-B	100	65	50

## Mounting Block (Required)<sup>②</sup>

Catalog Number
MB9301
MBR9302

## All PD, RD Frames:

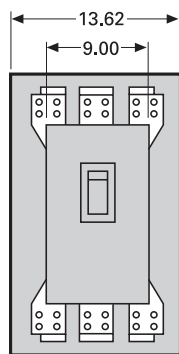

MB9301 (shown)  
MBR9302

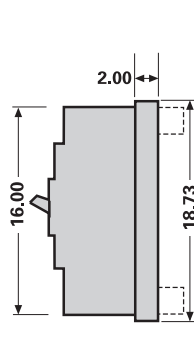

MBR9302

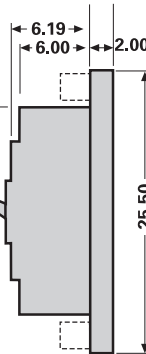

MB9301



MBR9302



MB9301

For inches / millimeters conversion, see Application Data section.

**Note:** "G" suffix in catalog number denotes circuit breaker for 3-phase, 3-wire circuits.  
For 3-phase, 4-wire, order correct 4th wire (neutral) transformer as separate and additional item.

All breakers built to order. Allow 2-3 weeks for delivery.  
<sup>①</sup> For additional information, see **Note: A**, page 7-135.  
<sup>②</sup> The PD frame circuit breaker requires the use of a connect-all mounting assembly to allow for placing into service.

<sup>③</sup> Advanced trip unit equipped with DAS / Maintenance Mode. Requires customer-supplied 24V external power supply, maintenance switch and light.

# Molded Case Circuit Breakers

## Internal Accessories

## Selection

Accessories for:

MD/SMD 800A Frame  
ND/SND 1200A Frame  
PD/SPD 1600A Frame  
RD 2000A Frame



S01MN6

Accessory modules can mount in either left hand or right hand poles of all circuit breakers, including solid state. Exception: when mechanical interlock is used. Accessories cannot be mounted in left pole.

## Shunt Trip Combinations

Control Voltage		1 Shunt Trip	1 Shunt Trip and 1 Auxiliary Switch
AC	DC	Catalog Number	Catalog Number
120		S01MN6	S01MN64A
208		S02MN6▲	—
240		S03MN6	S03MN64A▲
277		S15MN6▲	S15MN64A▲
480		S04MN6▲	S04MN64A▲
600		S06MN6▲	—
	12	S16MN6▲	S16MN64A▲
	24	S07MN6	S07MN64A
	48	S09MN6▲	—
	125	S11MN6	S11MN64A▲
	250	S13MN6▲	S13MN64A▲

## Undervoltage Trip Combinations

Control Voltage		1 Undervoltage Trip	1 Undervoltage Trip and 1 Auxiliary Switch	1 Undervoltage Trip and 2 Auxiliary Switches
AC	DC	Catalog Number	Catalog Number	Catalog Number
120		U01MN6	U01MN64A	U01MN64AA
208		U02MN6▲	U02MN64A▲	U02MN64AA▲
240		U03MN6▲	U03MN64A▲	U03MN64AA▲
277		U15MN6▲	U15MN64A▲	U15MN64AA▲
480		U04MN6▲	U04MN64A▲	U04MN64AA▲
600		U06MN6▲	—	—
	24	U07MN6	U07MN64A	U07MN64AA
	48	U09MN6▲	U09MN64A▲	U09MN64AA▲
	125	U11MN6▲	U11MN64A▲	U11MN64AA▲
	250	U13MN6▲	U13MN64A▲	U13MN64AA▲

## Auxiliary Switch Combinations

Maximum Voltage		1 Form C	2 Form C
AC	DC	Catalog Number	Catalog Number
480	250	A01MN64	A02MN64
—	12	A01MNDLV▲	A02MNDLV▲

## Alarm Switch Combinations

Maximum Voltage		1 Alarm Switch	1 Alarm Switch and 1 Auxiliary Switch	1 Alarm Switch and 2 Auxiliary Switches
AC	DC	Catalog Number	Catalog Number	Catalog Number
480	250	B00MN64	A01MN64B	A02MN64B

## ETU Testing Unit

Breaker Type	Description	Catalog Number
SJD, SLD, SMD, SND, SPD	Power Stick	EPSP18V
	Spare cable for Power Stick	COMPCA

The EPSP18V Power Stick is a hand-held, battery-operated power supply that can be used for trip testing the Sensitrip IV electronic trip units. Requires two 9V batteries.

▲ Built to order. Allow 6–8 weeks for delivery.



# Molded Case Circuit Breakers

RD 2000A Frame Sentron Series

Selection

## Type RXD6<sup>④</sup>

3-Pole 600V AC, 250-500V DC<sup>①</sup>

Blue Label

Non-Interchangeable Trip (Assembled Circuit Breaker Only Without Lugs)			
Continuous Current Rating @ 40°C	Complete Breaker Assembled (Frame/ Trip Unit Only) Catalog Number	Mounting Assembly Catalog Number	Lugs (6 required) Catalog Number
1600	RXD63B160	MB9301	TC5R600
1800	RXD63B180	-or-	
2000	RXD63B200	MBR9302	

## Type RD6<sup>④</sup>

3-Pole 600V AC, 250-500V DC<sup>①</sup>

Blue Label

Interchangeable Trip (Unassembled Circuit Breaker with Lugs)					
Continuous Current Rating @ 40°C	Complete Breaker Unassembled Catalog Number	Frame Only Catalog Number	Trip Unit Only Catalog Number	Mounting Assembly Catalog Number	Lugs (6 required) Catalog Number
1600	RD63B160■	RD63F200	RD63T160■	MB9301	TC5R600
1800	RD63B180		RD63T180	-or-	
2000	RD63B200		RD63T200	MBR9302	

## Type HRXD6<sup>④</sup>

Black Label

Continuous Current Rating @ 40°C	Complete Breaker Assembled (Frame/Trip Unit Only)	
	Catalog Number	
1600	HRXD63B160■	
1800	HRXD63B180■	
2000	HRXD63B200	

## Type HRD6<sup>④</sup>

Black Label

Continuous Current Rating @ 40°C	Complete Breaker Unassembled Catalog Number	Frame Only Catalog Number	Trip Unit Only Catalog Number	Mounting Assembly Catalog Number	Lugs (6 required) Catalog Number
1600	HRD63B160■	HRD63F200	RD63T160■	MB9301	TC5R600
1800	HRD63B180		RD63T180	-or-	
2000	HRD63B200		RD63T200	MBR9302	

## Interrupting Ratings

Breaker Type	UL 489 A IR					
	RMS Symmetrical KA					
	Volts AC			Volts DC <sup>①</sup>		
	240	480	600	250	500	
RD6, RXD6	65	50	25	30 (2P)	25 (3P)	
HRD6, HRXD6	100	65	50	30 (2P)	50 (3P)	

## Instantaneous Adjustment Trip Range (PD / RD Frames)

Breaker Ampere Rating	Nominal Instantaneous Values							±20% Tolerance High
	±20% Tolerance Low	2	3	4	5	6	7	
	1200-2000	5000	5715	6430	7145	7860	8575	

■ Built to order. Allow 2-3 weeks for delivery.

▲ Built to order. Allow 6-8 weeks for delivery.

① Use two outside poles of a 3-pole circuit breaker for 250V DC applications.

④ When wired as shown on page 7-4, this circuit breaker is UL listed and rated for use on 500V DC ungrounded UPS systems only.

⑤ RXD6 and HRXD6 type circuit breakers are UL Listed for reverse feed applications.

⑥ HACR rated.

⑦ For additional information See Note: A, page 7-135.

Note: RD frame qualified to UL489 supplement B "NAVAL". See page 7-138 for additional information.

⑧ For required mounting base (MB9301 or MBR9302) see page 7-119.



RXD63B200

## Mounting Block<sup>⑧</sup>

Catalog Number	Connection Points
MB9301	Front
MBR9302	Rear

## Shipping Weights

Number of Poles	Number per Carton	Shipping Weight (lbs.)
PXD6, HPXD6, RXD6, HRXD6, CPD6 Assembled Breakers		
3	1	61.5
PD6, HPD6, RD6, HRD6 Frame Only		
3	1	55.0
PD6, RD6 Trip Unit Only		
3	1	6.5
Mounting Assembly		
MB9301	1	53.0
MBR9302	1	50.9

## Lugs (6 required per breaker)<sup>⑧</sup>

Catalog Number	No of Cables per Connector	Wire Range
TC5R600	1-5	300-600 kcmil Cu only
TA6R600	1-6	300-600 kcmil Cu/Al

7 MOLDED CASE CIRCUIT BREAKERS

# Molded Case Circuit Breakers

Magnetic Trip Only — ETI Motor Circuit Protector

Selection

Breaker Type	Ampere Rating	Instantaneous Trip Range <sup>②</sup>		Complete Circuit Breaker Without Lugs <sup>③</sup>		
		Minimum <sup>③</sup>	Maximum <sup>③</sup>	Catalog Number 2-Pole	Catalog Number 3-Pole	
<b>HEM</b>	3	9	33	—	HEM3M003L	
	7	21	77	—	HEM3M007L	
	15	45	165	—	HEM3M015L	
	30	90	330	—	HEM3M030L	
	50	150	550	—	HEM3M050L	
	70	210	770	—	HEM3M070L	
	100	300	1100	—	HEM3M100L	
SHIPPING:					3.7 lbs. each	
<b>ED6-A</b> 600V AC 250V DC	1	2.6	9	—	ED63A001	
	2	7	22	—	ED63A002	
	3	10	35	—	ED63A003	
	5	16	54	—	ED63A005	
	10	30	100	—	ED63A010	
	25	55	180	—	ED63A025	
	30	80	270	—	ED63A030	
	40	115	375	—	ED63A040	
	50	180	600	—	ED63A050	
	100	315	1000	—	ED63A100	
	125	500	1250	—	ED63A125	
	SHIPPING:					3.8 lbs. each
	<b>CED6-A</b> 600V AC 250V DC	1	2.6	9	—	CED63A001■
2		7	22	—	CED63A002■	
3		10	35	—	CED63A003■	
5		16	54	—	CED63A005■	
10		30	100	—	CED63A010■	
25		55	180	—	CED63A025■	
30		80	270	—	CED63A030■	
40		115	375	—	CED63A040■	
50		180	600	—	CED63A050■	
100		315	1000	—	CED63A100■	
125	500	1250	—	CED63A125■		
SHIPPING:					6 lbs. each	
<b>FXD6</b> <sup>④</sup> 600V AC 250V DC	150	400	800	—	FXD63L150■	
	150	800	1500	—	FXD63A150	
	150	1100	2500	—	FXD63H150	
	250	1100	2500	—	FXD63A250	
SHIPPING:					9 lbs. each	
<b>CFD6</b> <sup>④</sup> 600V AC 250V DC	150	400	800	—	CFD63L150■	
	150	800	1500	—	CFD63A150■	
	150	1100	2500	—	CFD63H150■	
	250	1100	2500	—	CFD63A250■	
SHIPPING:					12 lbs. each	
<b>JXD6(A)</b> <sup>①</sup> 600V AC 250V DC	400	1250	2500	—	JXD63L400	
	400	2000	4000	JXD62H400■	JXD63H400	
SHIPPING:					16 lbs. each	
<b>CJD6</b> <sup>①</sup> 600V AC 250V DC	400	1250	2500	—	CJD63L400■	
	400	2000	4000	—	CJD63H400■	
SHIPPING:					29.5 lbs. each	
<b>LXD6(A)</b> <sup>①</sup> 600V AC 250V DC	600	2000	4000	LXD62L600■	LXD63L600■	
	600	3000	6000	—	LXD63H600	
SHIPPING:					20 lbs. each	
<b>CLD6</b> <sup>①</sup> 600V AC 250V DC	600	2000	4000	—	CLD63L600■	
	600	3000	6000	—	CLD63H600■	
SHIPPING:					31.5 lbs. each	
<b>LMXD6</b> <sup>④</sup> 600V AC 250V DC	800	2800	6000	—	LMXD63L800■	
	800	3200	8000	—	LMXD63A800	
SHIPPING:					35 lbs. each	
<b>MXD6</b> <sup>④</sup> 600V AC 250V DC	800	3000	6000	—	MXD63L800■	
	800	4000	8000	—	MXD63A800■	
	800	5000	10000	—	MXD63H800	
SHIPPING:					33 lbs. each	
<b>CMD6</b> <sup>④</sup> 600V AC 250V DC	800	3000	6000	—	CMD63L800■	
	800	4000	8000	—	CMD63A800■	
	800	5000	10000	—	CMD63H800■	
SHIPPING:					80 lbs. each	

## Important Information

ETI interrupting ratings are determined through combination tests with properly sized overload relays and contactors.

③ Connectors included when ordering by circuit breaker catalog number for HEM, ED and CED6 ETIs. Order ETI circuit breaker and lugs (2 per pole) separately for the FXD6, CFD6, MXD6, CMD6, JXD6, CJD6, LXD6 and CLD6 ETI's.

■ Built to order. Allow 2-3 weeks for delivery.

④ 2-pole available in 3-pole width only.

② When applied on DC Circuits — Trip levels will increase approximately +15 to 20%.

③ Tolerance -20%/+30% for lowest setting. All other set-

tings are -20%/+20%

④ For 2-pole application use outside poles of 3-pole circuit breaker.

Lug Information pages 7-135 to 7-137  
Enclosures Section 6  
Accessories pages 7-142 to 7-147  
Application data pages 7-123 to 7-124

# Molded Case Circuit Breakers

## Motor Circuits

## Application

### General

#### Protection of Motor Circuits

Molded case circuit breakers are used in motor circuits as a disconnecting means and for short-circuit protection. They should be used in conjunction with motor-running, over-current-protection devices, and should permit the motor to start without nuisance tripping from motor-inrush current. The circuit breaker should have a continuous-current rating of not less than 115% of the motor full-load current.

The recommended motor circuit protectors (Siemens ETI instantaneous only circuit breakers) listed have

continuous-current ratings of at least 115% of motor full-load currents. The trip-setting positions are approximately 11 times motor full-load currents. The suggested trip settings may have to be adjusted upward to no higher than 1300% of full-load current for non-design E type motors, and no greater than 1700% of full load current for design E motors, to allow for motor start-up due to inrush currents.

#### Breaker Mounted Immediately Ahead of Motor Starter

Siemens ETI motor circuit protectors are recommended for use in combination motor starters to provide selective short-circuit protection for the motor

branch circuit. The adjustable instantaneous-trip feature of the Siemens ETI motor circuit protector provides for a trip setting slightly above the peak motor-inrush current. With this setting, no delay is introduced in opening the circuit when a fault occurs. This circuit breaker has no time-delay trip element. Therefore it must be used in conjunction with, and immediately ahead of, the motor-running overcurrent protective device.

Important: The information below does not apply to all motor applications: it is recommended that the user refer to the National Electrical Code (NEC) for specific needs.

**Table 1 (When Breaker is Mounted Immediately Ahead of Motor Starter)**

3-Phase Induction Type Motors (Siemens ETI motor circuit protectors for branch circuit use with alternating-current combination, full voltage motor starters).

Motor Full Load Amperes	Catalog Number	ETI Trip Setting	
		Adjustment	Amperes
0.69 - 0.91 1.1 - 1.3 1.6 - 1.7 2.0 - 2.2 2.3 - 2.5 2.6 - 2.8	HEM3M003L	A (min)	9
		B	15
		C	21
		D	27
		E	30
		F (max)	33
1.5 - 2.0 2.6 - 3.1 3.7 - 3.9 4.8 - 5.2 5.3 - 5.7 5.8 - 6.1	HEM3M007L	A (min)	21
		B	35
		C	49
		D	63
		E	70
		F (max)	77
3.4 - 4.5 5.7 - 6.8 8.0 - 9.1 10.4 - 11.4 11.5 - 12.6 12.7 - 13.0	HEM3M015L	A (min)	45
		B	75
		C	100
		D	135
		E	150
		F (max)	165
3.9 - 9.1 11.5 - 13.7 16.1 - 18.3 20.7 - 22.9 23.0 - 25.2 25.3 - 26.1	HEM3M030L	A (min)	90
		B	150
		C	210
		D	270
		E	300
		F (max)	330
11.5 - 15.2 19.2 - 22.9 26.9 - 30.6 34.6 - 38.3 38.4 - 42.1 42.2 - 43.5	HEM3M050L	A (min)	150
		B	250
		C	350
		D	450
		E	500
		F (max)	550
16.1 - 30.6 26.9 - 32.2 37.6 - 42.9 48.4 - 53.7 53.8 - 59.1 59.2 - 60.9	HEM3M070L	A (min)	210
		B	350
		C	490
		D	630
		E	700
		F (max)	770
23.0 - 30.9 38.4 - 46.0 53.8 - 61.4 69.2 - 76.8 76.9 - 84.5 84.6 - 87.0	HEM3M100L	A (min)	300
		B	500
		C	700
		D	900
		E	1000
		F (max)	1100
.20 - .33 .34 - .45 .46 - .56 .57 - .68 .69 - .81	ED63A001 CED63A001	Low	2.6
		2	4.5
		3	6
		4	7.5
		High	9
		.53 - .83 .84 - 1.14 1.15 - 1.45 1.46 - 1.68 1.69 - 2.00	ED63A002 CED63A002
2	11		
3	15		
4	19		
High	22		
.76 - 1.29 1.30 - 1.75 1.76 - 2.29 2.30 - 2.68 2.69 - 3.18	ED63A003 CED63A003		
		2	17
		3	23
		4	30
		High	35

Motor Full Load Amperes	Catalog Number	ETI Trip Setting	
		Adjustment	Amperes
1.23 - 1.99 2.00 - 2.75 2.76 - 3.52 3.53 - 4.14 4.15 - 4.90	ED63A005 CED63A005	Low	16
		2	26
		3	36
		4	46
		High	54
		2.30 - 3.83 3.84 - 5.37 5.38 - 6.52 6.53 - 7.68 7.69 - 9.10	ED63A010 CED63A010
2	50		
3	70		
4	85		
High	100		
4.23 - 6.91 6.92 - 9.61 9.62 - 11.91 11.92 - 13.83 13.84 - 16.40	ED63A025 CED63A025		
		2	90
		3	125
		4	155
		High	180
		6.15 - 10.37 10.38 - 14.22 14.23 - 18.06 18.07 - 20.75 20.76 - 24.50	ED63A030 CED63A030
2	135		
3	185		
4	235		
High	270		
8.84 - 14.22 14.23 - 19.60 19.61 - 24.99 25.00 - 28.83 28.84 - 34.00	ED63A040 CED63A040		
		2	185
		3	255
		4	325
		High	375
		13.84 - 23.06 23.07 - 31.52 31.53 - 39.99 40.00 - 46.14 46.15 - 54.50	ED63A050 CED63A050
2	300		
3	410		
4	520		
High	600		
24.23 - 41.52 41.53 - 56.91 56.92 - 68.45 68.46 - 76.91 76.92 - 90.90	ED63A100 CED63A100		
		2	540
		3	740
		4	890
		High	1000
		38.46 - 55.37 55.38 - 70.75 70.76 - 84.60 84.61 - 96.14 96.15 - 113.60	ED63A125 CED63A125
2	720		
3	920		
4	1100		
High	1250		
30.76 - 35.37 35.38 - 39.99 44.51 - 49.23 53.84 - 58.45 58.46 - 63.06 63.07 - 74.50	FXD63L150 CFD63L150		
		2	460
		4	580
		6	700
		7	760
		High	820
61.53 - 69.22 69.23 - 76.91 84.61 - 92.29 100.00 - 108.00 108.00 - 115.00 115.00 - 136.00	FXD63A150 CFD63A150	Low	800
		2	900
		4	1100
		6	1300
		7	1400
		High	1500
85.00 - 100.00 100.00 - 115.00 131.00 - 146.00 162.00 - 177.00 177.00 - 192.00 192.00 - 227.00	FXD63A250 CFD63A250	Low	1100
		2	1300
		4	1700
		6	2100
		7	2300
		High	2500

Motor Full Load Amperes	Catalog Number	ETI Trip Setting	
		Adjustment	Amperes
95.00 - 110.00 110.00 - 124.00 138.00 - 151.00 165.00 - 178.00 178.00 - 192.00 192.00 - 227.00	JXD63L400 CJD63L400	Low	1250
		2	1430
		4	1790
		6	2140
		7	2320
		High	2500
		154.00 - 176.00 176.00 - 198.00 220.00 - 242.00 264.00 - 285.00 285.00 - 308.00 308.00 - 326.00	JXD63H400 CJD63H400
2	2290		
4	2860		
6	3430		
7	3710		
High	4000		
155.00 - 176.00 176.00 - 198.00 220.00 - 242.00 264.00 - 285.00 285.00 - 308.00 308.00 - 326.00	LXD63L600 CLD63L600		
		2	2290
		4	2860
		6	3430
		7	3710
		High	4000
		231.00 - 264.00 264.00 - 292.00 330.00 - 362.00 395.00 - 428.00 428.99 - 462.00 462.00 - 490.00	LXD63H600 CLD63H600
2	3430		
4	4290		
6	5140		
7	5570		
High	6000		
215.00 - 238.00 238.00 - 261.00 261.00 - 284.00 308.00 - 369.00 369.00 - 423.00 423.00 - 462.00 462.00 - 490.00	LTXD63L800		
		2	3100
		3	3400
		5	4000
		6	4800
		7	5500
		High	6000
246.00 - 269.00 269.00 - 284.00 284.00 - 323.00 362.00 - 492.00 492.00 - 562.00 562.00 - 616.00 616.00 - 660.00	LTXD63A800	Low	3200
		2	3500
		3	3700
		5	4700
		6	6400
		7	7300
		High	8000
231.00 - 264.00 264.00 - 292.00 292.00 - 330.00 362.00 - 395.00 428.00 - 462.00 462.00 - 490.00	MXD63L800 CMD63L800	Low	3000
		2	3430
		3	3800
		5	4710
		7	5570
		High	6000
		308.00 - 352.00 352.00 - 442.00 442.00 - 447.00 483.00 - 527.00 571.00 - 616.00 616.00 - 660.00	MXD63A800 CMD63A800
2	4570		
3	5740		
5	6280		
7	7240		
High	8000		
385.00 - 440.00 495.00 - 550.00 605.00 - 660.00 660.00 - 695.00	MXD63H800 CMD63H800		
		3	6430
		5	7860
		6	8575

Note: Lowest instantaneous settings have a -20%/+30% tolerance and all other settings have a -20%/+20% tolerance.

MOLDED CASE  
CIRCUIT BREAKERS

# Molded Case Circuit Breakers

## Motor Circuits

## Application

### Breaker Mounted at a Distance From Motor Starter

ET thermal-magnetic circuit breakers conform to the National Electrical Code table 430-52 requirements for motor branch and feeder circuit protection when properly applied in conjunction with motor-running overcurrent protective devices. The recommended

circuit-breaker ratings in Table 2 provide adequate time delay for starting the majority of three phase induction motors.

To determine the ampere ratings of the ET breaker to protect a motor feeder, add the rating of the ET breaker used to protect the largest motor branch circuit in the group to the full-load currents of the remaining motors in the group.

### Interrupt Ratings

For normal commercial purposes, available fault current can conveniently be obtained in the Interrupting Selector Tables.

**Table 2 (When Breaker is Mounted at a Distance From Motor Starter)**

3-Phase Induction Type Motors (EQ and ET circuit breakers (thermal-magnetic trip) for branch breaker use with alternating-current combination motor starters).

Motor Horsepower Rating	200 and 208V Motors			230V Motors			460V Motors			575V Motors		
	240V Circuit Breaker Data <sup>①</sup>			240V Circuit Breaker Data <sup>①</sup>			480V Circuit Breaker Data <sup>①</sup>			600V Circuit Breaker Data <sup>①</sup>		
	Breaker Type	Catalog Number	Ampere Rating	Breaker Type	Catalog Number	Ampere Rating	Breaker Type	Catalog Number	Ampere Rating	Breaker Type	Catalog Number	Ampere Rating
1/2	BQ <sup>®</sup>	BQ3B015	15	BQ <sup>®</sup>	BQ3B015	15	ED4	ED43B015	15	ED6	ED63B015	15
3/4		BQ3B015	15		BQ3B015	15		ED43B015	15		ED63B015	15
1		BQ3B015	15		BQ3B015	15		ED43B015	15		ED63B015	15
1 1/2		BQ3B015	15		BQ3B015	15		ED43B015	15		ED63B015	15
2		BQ3B020	20		BQ3B015	15		ED43B015	15		ED63B015	15
3		BQ3B030	30		BQ3B020	20		ED43B015	15		ED63B015	15
5	BQ <sup>®</sup>	BQ3B040	40	BQ <sup>®</sup>	BQ3B030	30	ED4	ED43B015	15	ED6	ED63B015	15
7 1/2		BQ3B060	60		BQ3B050	50		ED43B030	30		ED63B020	20
10		BQ3B070	70		BQ3B070	70		ED43B030	30		ED63B030	30
15		BQ3B100	100		BQ3B090	90		ED43B040	40		ED63B035	35
20					BQ3B100	100		ED43B050	50		ED63B050	50
25	FXD6	FXD63B125	125	FXD6	FXD63B125	125	FXD6	FXD63B090	90	FXD6	FXD63B060	60
30		FXD63B150	150		FXD63B150	150		FXD63B100	100		FXD63B070	70
40		FXD63B175	175		FXD63B175	175		FXD63B125	125		FXD63B090	90
50		FXD63B200	200		FXD63B200	200		FXD63B150	150		FXD63B100	100
		FXD63B225	225									
60	JXD2	JXD23B300	300	—	—	—	FXD6, FD6	FXD63B150	150	FXD6	FXD63B100	100
75	JXD2	JXD23B400	400	JXD2	JXD23B350	350	FXD6, FD6	FXD63B200	200	FXD6, FD6	FXD63B125	125
100	JXD2	JXD23B400	400	JXD2	JXD23B400	400	FD6 <sup>®</sup> JD6 <sup>®</sup>	FD63B250 JD63B250	250 250	FXD6, FD6	FD63B175	175
125	LD6 <sup>®</sup> or LMD6	LD63B600 LMD63B600	600	LD6 <sup>®</sup> or LMD6	LD63B500 or LMD63B500	500	JD6 <sup>®</sup>	JD63B300	300	FXD6, FD6 OR JD6 <sup>®</sup>	FXD63B200 JD63B200	200 200
150	LD6 <sup>®</sup> or LMD6	LD63B600 or LMD63B600	600	LMD6	LD63B600 or LMD63B600	600	JD6 <sup>®</sup>	JD63B300	300	FXD6 or JD6 <sup>®</sup>	FXD63B225 JD63B225	225 225
200	LMD6	LMD63B800	800	LMD6	LMD63B800	800	JD6 <sup>®</sup>	JD63B350	350	JD6 <sup>®</sup>	JD63B300	300
250	—	—	—	—	—	—	JD6 <sup>®</sup>	JD63B400	400	JD6 <sup>®</sup>	JD63B400	400
300	—	—	—	—	—	—	LD6 <sup>®</sup> or LMD6	LD63B600 or LMD63B600	600	JD6 <sup>®</sup>	JD63B400	400
350	—	—	—	—	—	—	LMD6	LMD63B700	700	LD6 <sup>®</sup> or LMD6	LD63B500 or LMD63B500	500
400	—	—	—	—	—	—	LMD6	LMD63B800	800	LD6 <sup>®</sup> or LMD6	LD63B600 or LMD63B600	600
500	—	—	—	—	—	—	—	—	—	LMD6	LMD63B800	800

①The selection of breakers for this table is in accordance with Article 430, 2005 National Electric Code. Recommended circuit breakers are for full voltage starting, special consideration is necessary for reduced voltage starting.

②For panelboard applications, substitute the BL breaker for the BQ, ED2 circuit breakers may also be used.

③For non-interchangeable trip applications, substitute the FXD6 for the FD6, the JXD6 for the JD6, or the LXD6 for the LD6.



# Molded Case Circuit Breakers

## Adjustable Instantaneous Magnetic Trip Settings

## Application

Breaker Type	Maximum Continuous Amperes	Nominal AC Adjustable Trip Range								ETI Motor Circuit Protector Catalog Number			Thermal Magnetic Catalog Number		
		Low	2	3	4	5	6	7	High	3-Pole	2-Pole	3-Pole			
JXD2(A)	200	1250	1430	1610	1790	1960	2140	2320	2500	—	JXD22B200	JXD23B200			
	225	1250	1430	1610	1790	1960	2140	2320	2500	—	JXD22B225	JXD23B225			
	250	1250	1430	1610	1790	1960	2140	2320	2500	—	JXD22B250	JXD23B250			
	300	1250	1430	1610	1790	1960	2140	2320	2500	—	JXD22B300	JXD23B300			
	350	2000	2290	2570	2860	3140	3430	3710	4000	—	JXD22B350	JXD23B350			
	400	2000	2290	2570	2860	3140	3430	3710	4000	—	JXD22B400	JXD23B400			
JXD6(A)	200	1250	1430	1610	1790	1960	2140	2320	2500	—	JXD62B200	JXD63B200			
	225	1250	1430	1610	1790	1960	2140	2320	2500	—	JXD62B225	JXD63B225			
	250	1250	1430	1610	1790	1960	2140	2320	2500	—	JXD62B250	JXD63B250			
	300	1250	1430	1610	1790	1960	2140	2320	2500	—	JXD62B300	JXD63B300			
	350	2000	2290	2570	2860	3140	3430	3710	4000	—	JXD62B350	JXD23B350			
	400	2000	2290	2570	2860	3140	3430	3710	4000	—	JXD62B400	JXD23B400			
JD6(A)	200	1250	1430	1610	1790	1960	2140	2320	2500	—	JD62B200	JD63B200			
	225	1250	1430	1610	1790	1960	2140	2320	2500	—	JD62B225	JD63B225			
	250	1250	1430	1610	1790	1960	2140	2320	2500	—	JD62B250	JD63B250			
	300	1250	1430	1610	1790	1960	2140	2320	2500	—	JD62B300	JD63B300			
	350	2000	2290	2570	2860	3140	3430	3710	4000	—	JD62B350	JD63B350			
	400	2000	2290	2570	2860	3140	3430	3710	4000	—	JD62B400	JD63B400			
HJD6(A)	200	1250	1430	1610	1790	1960	2140	2320	2500	—	HJD62B200	HJD63B200			
	225	1250	1430	1610	1790	1960	2140	2320	2500	—	HJD62B225	HJD63B225			
	250	1250	1430	1610	1790	1960	2140	2320	2500	—	HJD62B250	HJD63H250			
	300	1250	1430	1610	1790	1960	2140	2320	2500	—	HJD62B300	HJD63B300			
	350	2000	2290	2570	2860	3140	3430	3710	4000	—	HJD62B350	HJD63B350			
	400	2000	2290	2570	2860	3140	3430	3710	4000	—	HJD62H400	HJD63B400			
HHJD6	200	1250	1430	1610	1790	1960	2140	2320	2500	—	HHJD62B200	HHJD63B200			
	225	1250	1430	1610	1790	1960	2140	2320	2500	—	HHJD62B225	HHJD63B225			
	250	1250	1430	1610	1790	1960	2140	2320	2500	—	HHJD62B250	HHJD63B250			
	300	1250	1430	1610	1790	1960	2140	2320	2500	—	HHJD62B300	HHJD63B300			
	350	2000	2290	2570	2860	3140	3430	3710	4000	—	HHJD62B350	HHJD63B350			
	400	2000	2290	2570	2860	3140	3430	3710	4000	—	HHJD62B400	HHJD63B400			
CJD6	200	1250	1430	1610	1790	1960	2140	2320	2500	—	—	CJD63B200			
	225	1250	1430	1610	1790	1960	2140	2320	2500	—	—	CJD63B225			
	250	1250	1430	1610	1790	1960	2140	2320	2500	—	—	CJD63B250			
	300	1250	1430	1610	1790	1960	2140	2320	2500	—	—	CJD63B300			
	350	2000	2290	2570	2860	3140	3430	3710	4000	—	—	CJD63B350			
	400	2000	2290	2570	2860	3140	3430	3710	4000	—	—	CJD63B400			
LXD6(A)	450	2000	2290	2570	2860	3140	3430	3710	4000	—	LXD62B450	LXD63B450			
	500	3000	3430	3860	4290	4710	5140	5570	6000	—	LXD62B500	LXD63B500			
	600	3000	3430	3860	4290	4710	5140	5570	6000	—	LXD62B600	LXD63B600			
	250	1250	1430	1610	1790	1960	2140	2320	2500	—	LD62B250	LD63B250			
	300	1250	1430	1610	1790	1960	2140	2320	2500	—	LD62B300	LD63B300			
	350	2000	2290	2570	2860	3140	3430	3710	4000	—	LD62B350	LD63B350			
LD6(A)	400	2000	2290	2570	2860	3140	3430	3710	4000	—	LD62B400	LD63B400			
	450	2000	2290	2570	2860	3140	3430	3710	4000	—	LD62B450	LD63B450			
	500	3000	3430	3800	4290	4710	5140	5570	6000	—	LD62B500	LD63B500			
	600	2000	2290	2570	2860	3140	3430	3710	4000	—	—	—			
	600	3000	3430	3800	4290	4710	5140	5570	6000	—	LXD63L600	—			
	600	3000	3430	3800	4290	4710	5140	5570	6000	—	LXD63H600	LD63B600			
HLD6(A)	250	1250	1430	1610	1790	1960	2140	2320	2500	—	HLD62B250	HLD63B250			
	300	1250	1430	1610	1790	1960	2140	2320	2500	—	HLD62B300	HLD63B300			
	350	2000	2290	2570	2860	3140	3430	3710	4000	—	HLD62B350	HLD63B350			
	400	2000	2290	2570	2860	3140	3430	3710	4000	—	HLD62B400	HLD63B400			
	450	2000	2290	2570	2860	3140	3430	3710	4000	—	HLD62B450	HLD63B450			
	500	3000	3430	3860	4290	4710	5140	5570	6000	—	HLD62B500	HLD63B500			
HHL6	250	1250	1430	1610	1790	1960	2140	2320	2500	—	HHL62B250	HHL63B250			
	300	1250	1430	1610	1790	1960	2140	2320	2500	—	HHL62B300	HHL63B300			
	350	2000	2290	2570	2860	3140	3430	3710	4000	—	HHL62B350	HHL63B350			
	400	2000	2290	2570	2860	3140	3430	3710	4000	—	HHL62B400	HHL63B400			
	450	2000	2290	2570	2860	3140	3430	3710	4000	—	HHL62B450	HHL63B450			
	500	3000	3430	3860	4290	4710	5140	5570	6000	—	HHL62B500	HHL63B500			
CLD6	250	1250	1430	1610	1790	1960	2140	2320	2500	—	—	CJD63B250			
	300	1250	1430	1610	1790	1960	2140	2320	2500	—	—	CJD63B300			
	350	2000	2290	2570	2860	3140	3430	3710	4000	—	—	CJD63B350			
	400	2000	2290	2570	2860	3140	3430	3710	4000	—	—	CLD63B400			
	450	2000	2290	2570	2860	3140	3430	3710	4000	—	—	CLD63B450			
	500	3000	3430	3860	4290	4710	5140	5570	6000	—	—	CLD63B500			
LMXD6	500	3000	3430	3860	4290	4710	5140	5570	6000	—	—	LMXD63B500			
	600	3000	3430	3860	4290	4710	5140	5570	6000	—	—	LMXD63B600			
	700	3200	3500	3700	4200	4700	6400	7300	8000	—	LMXD62B600	LMXD63B700			
	800	2800	3100	3400	3700	4000	4800	5500	6000	—	LMXD62B700	LMXD63B800			
	800	3200	3500	3700	4200	4700	6400	7300	8000	—	LMXD62B800	LMXD63B800			
	800	3200	3500	3700	4200	4700	6400	7300	8000	—	—	—			
LMD6	500	3000	3430	3860	4290	4710	5140	5570	6000	—	LMD62B500	LMD63B500			
	600	3000	3430	3860	4290	4710	5140	5570	6000	—	LMD62B600	LMD63B600			
	700	3200	3500	3700	4200	4700	6400	7300	8000	—	LMD62B700	LMD63B700			
	800	3200	3500	3700	4200	4700	6400	7300	8000	—	LMD62B800	LMD63B800			

# Molded Case Circuit Breakers

## Adjustable Instantaneous Magnetic Trip Settings

Application

Breaker Type	Maximum Continuous Amperes	Nominal AC Adjustable Trip Range								ETI Motor Circuit Protector Catalog Number	Thermal Magnetic Catalog Number		
		Low	2	3	4	5	6	7	High		3-Pole	2-Pole	3-Pole
HLMXD6	500	3000	3430	3860	4290	4710	5140	5570	6000	—	—	—	HLMXD63B500
	600	3000	3430	3860	4290	4710	5140	5570	6000	—	—	—	HLMXD63B600
	700	3200	3500	3700	4200	4700	6400	7300	8000	—	—	—	HLMXD63B700
	800	3200	3500	3700	4200	4700	6400	7300	8000	—	—	—	HLMXD63B800
HLMD6	500	3000	3430	3860	4290	4710	5140	5570	6000	—	—	—	HLMD62B500
	600	3000	3430	3860	4290	4710	5140	5570	6000	—	—	—	HLMD62B600
	700	3200	3500	3700	4200	4700	6400	7300	8000	—	—	—	HLMD62B700
	800	3200	3500	3700	4200	4700	6400	7300	8000	—	—	—	HLMD62B800
MD6	500	3000	3430	3860	4290	4710	5140	5570	6000	—	—	—	MD62B500
	600	3000	3430	3860	4290	4710	5140	5570	6000	—	—	—	MD62B600
	700	4000	4570	5140	5710	6280	6850	7420	8000	—	—	—	MD62B700
	800	3000	3430	3860	4280	4710	5140	5570	6000	MXD63L800	—	—	—
	800	4000	4570	5140	5710	6280	6850	7420	8000	MXD63A800	—	—	—
800	5000	5715	6430	7145	7860	8575	9290	10000	MXD63H800	—	—	—	MD62B800
MXD6	500	3000	3430	3860	4280	4710	5140	5570	6000	—	—	—	MXD62B500
	600	3000	3430	3860	4280	4710	5140	5570	6000	—	—	—	MXD62B600
	700	4000	4570	5140	5710	6280	6850	7420	8000	—	—	—	MXD62B700
	800	3000	3430	3860	4280	4710	5140	5570	6000	MXD63L800	—	—	—
	800	4000	4570	5140	5710	6280	6850	7420	8000	MXD63A800	—	—	—
800	5000	5715	6430	7145	7860	8575	9290	10000	MXD63H800	—	—	—	MXD62B800
HMD6	500	3000	3430	3860	4280	4710	5140	5570	6000	—	—	—	HMD62B500
	600	3000	3430	3860	4280	4710	5140	5570	6000	—	—	—	HMD62B600
	700	4000	4570	5140	5710	6280	6850	7420	8000	—	—	—	HMD62B700
	800	4000	4570	5140	5710	6280	6850	7420	8000	—	—	—	HMD62B800
HMXD6	500	3000	3430	3860	4280	4710	5140	5570	6000	—	—	—	—
	600	3000	3430	3860	4280	4710	5140	5570	6000	—	—	—	—
	700	4000	4570	5140	5710	6280	6850	7420	8000	—	—	—	—
	800	4000	4570	5140	5710	6280	6850	7420	8000	—	—	—	—
CMD6	400	3000	3430	3860	4280	4710	5140	5570	6000	—	—	—	—
	500	3000	3430	3860	4280	4710	5140	5570	6000	—	—	—	—
	600	3000	3430	3860	4280	4710	5140	5570	6000	—	—	—	—
	700	4000	4570	5140	5710	6280	6850	7420	8000	—	—	—	—
	800	3000	3430	3860	4280	4710	5140	5570	6000	—	—	—	—
	800	4000	4570	5140	5710	6280	6850	7420	8000	—	—	—	—
800	5000	5715	6430	7145	7860	8575	9290	10000	—	—	—	—	
ND6	800	4000	4570	5140	5710	6280	6850	7420	8000	—	—	—	ND62B800
	900	5000	5715	6430	7145	7860	8575	9290	10000	—	—	—	ND62B900
	1000	5000	5715	6430	7145	7860	8575	9290	10000	—	—	—	ND62B100
	1200	5000	5715	6430	7145	7860	8575	9290	10000	—	—	—	ND62B120
NXD6	900	5000	5715	6430	7145	7860	8575	9290	10000	—	—	—	NXD62B900
	1000	5000	5715	6430	7145	7860	8575	9290	10000	—	—	—	NXD62B100
	1200	5000	5715	6430	7145	7860	8575	9290	10000	—	—	—	NXD62B120
HND6	800	4000	4570	5140	5710	6280	6850	7420	8000	—	—	—	HND62B800
	900	5000	5715	6430	7145	7860	8575	9290	10000	—	—	—	HND62B900
	1000	5000	5715	6430	7145	7860	8575	9290	10000	—	—	—	HND62B100
	1200	5000	5715	6430	7145	7860	8575	9290	10000	—	—	—	HND62B120
HNXD6	900	5000	5715	6430	7145	7860	8575	9290	10000	—	—	—	—
	1000	5000	5715	6430	7145	7860	8575	9290	10000	—	—	—	—
	1200	5000	5715	6430	7145	7860	8575	9290	10000	—	—	—	—
CND6	800	4000	4570	5140	5710	6280	6850	7420	8000	—	—	—	CND63B800
	900	5000	5715	6430	7145	7860	8575	9290	10000	—	—	—	CND63B900
	1000	5000	5715	6430	7145	7860	8575	9290	10000	—	—	—	CND63B100
	1200	5000	5715	6430	7145	7860	8575	9290	10000	—	—	—	CND63B120
PD6	1200	5000	5715	6430	7145	7860	8575	9290	10000	—	—	—	—
	1400	5000	5715	6430	7145	7860	8575	9290	10000	—	—	—	PD63B120
	1600	5000	5715	6430	7145	7860	8575	9290	10000	—	—	—	PD63B140
PXD6	1200	5000	5715	6430	7145	7860	8575	9290	10000	—	—	—	—
	1400	5000	5715	6430	7145	7860	8575	9290	10000	—	—	—	—
	1600	5000	5715	6430	7145	7860	8575	9290	10000	—	—	—	—
HPD6	1200	5000	5715	6430	7145	7860	8575	9290	10000	—	—	—	—
	1400	5000	5715	6430	7145	7860	8575	9290	10000	—	—	—	—
	1600	5000	5715	6430	7145	7860	8575	9290	10000	—	—	—	—
HPXD6	1200	5000	5715	6430	7145	7860	8575	9290	10000	—	—	—	—
	1400	5000	5715	6430	7145	7860	8575	9290	10000	—	—	—	—
	1600	5000	5715	6430	7145	7860	8575	9290	10000	—	—	—	—
CPD6	1200	5000	5715	6430	7145	7860	8575	9290	10000	—	—	—	—
	1400	5000	5715	6430	7145	7860	8575	9290	10000	—	—	—	—
	1600	5000	5715	6430	7145	7860	8575	9290	10000	—	—	—	—
RD6	1800	5000	5715	6430	7145	7860	8575	9290	10000	—	—	—	—
	2000	5000	5715	6430	7145	7860	8575	9290	10000	—	—	—	—
RXD6	1800	5000	5715	6430	7145	7860	8575	9290	10000	—	—	—	—
	2000	5000	5715	6430	7145	7860	8575	9290	10000	—	—	—	—
HRD6	1800	5000	5715	6430	7145	7860	8575	9290	10000	—	—	—	—
	2000	5000	5715	6430	7145	7860	8575	9290	10000	—	—	—	—
HRXD6	1800	5000	5715	6430	7145	7860	8575	9290	10000	—	—	—	—
	2000	5000	5715	6430	7145	7860	8575	9290	10000	—	—	—	—

7  
MOLDED CASE  
CIRCUIT BREAKERS

# Molded Case Circuit Breakers

## Molded Case Switch — Circuit Disconnect

Selection

Maximum Frame Amp Rating	2-Pole	3-Pole	Self-Protective Instantaneous Override $\pm 20\%$ <sup>③</sup>
	Catalog Number	Catalog Number	
100	BQ2S060■	BQ3S060■	1000
	BQ2S100■	BQ3S100■	1000
125	ED22S100A■	ED23S100A	1000
	ED42S100A■	ED43S100A	1000
	ED42S125A■	ED43S125A	1000
	ED62S100A■	ED63S100A	1000
	—	ED63S125A	1000
	CED62S100A■	CED63S100A■	1000
	CED62S125A■	CED63S125A■	1000
	—	HES3S100L	1250
	—	HES3S125L	1250
	250	—	HQR23S250HA
FXD62S250A		FXD63S250A	3200
HFXD62S250A■		HFXD63S250A■	3200
①		CFD63S250A■	3200
400	JXD22S400A■	JXD23S400A	6000
	—	JXD63S400A	6000
	—	HJXD63S400A■	6000
	①	CJD63S400A■	6000
600	—	LXD63S600A	6000
	—	HLXD63S600A■	6000
	①	CLD63S600A■	6000
800	—	LMXD63S800A■	8000
	—	MXD63S800A	8000
	①	CMD63S800A	8000
1200	—	NXD63S120A	10000
	①	CND63S120A■	10000
1600	①	PXD63S160A <sup>③</sup>	10000
2000	①	RXD63S200A■ <sup>③</sup>	10000

### Ordering Information

Order by catalog number. Switches include frame and self protective trip unit only. Order lugs separately from pages 7-135 to 7-137.

■ Built to order. Allow 2–3 weeks for delivery.

① For 2-pole application use outside poles of 3-pole circuit breaker.

② For additional lugs see pages 7-135 to 7-137.

③ Molded case switches up to R frame contain a self protecting instantaneous element, which may open circuit above their override set point.

④ UL file E57556 Volume 1, section 2 and CSA LR 42022-51.

⑤ Requires mounting block MB9301 or MBR9302.

Lugs pages 7-135 to 7-137  
 Enclosures Section 6  
 Accessories pages 7-142 to 7-147



# Molded Case Circuit Breakers

## Digital Solid State Sentron Sensitrip IV Series

Technical

The Sentron Sensitrip IV circuit breaker is a true RMS current sensing device. Digital microprocessor circuitry within the electronic trip unit provides more precise control over the circuit breaker functions. This control allows circuit coordination flexibility not available with thermal magnetic circuit breakers.

### Functions available in Sentron Sensitrip circuit breakers

Catalog Number Suffix	Trip Type	Cont Current Setting	Long Time Delay	Instantaneous Pickup	Short Time Pickup	Short Time Fixed Delay	Short Time I <sup>2</sup> t Delay	Ground Fault Pickup	Ground Fault Delay
LI	LI	✓	✓	✓					
LIG	LIG	✓	✓	✓				✓	✓
LSI	LSI	✓	✓	✓	✓	✓	✓		
LSIG	LSIG	✓	✓	✓	✓	✓	✓	✓	✓

### Typical Trip Unit Labeling and Adjustment Positions for the Sentron Sensitrip Circuit Breaker.

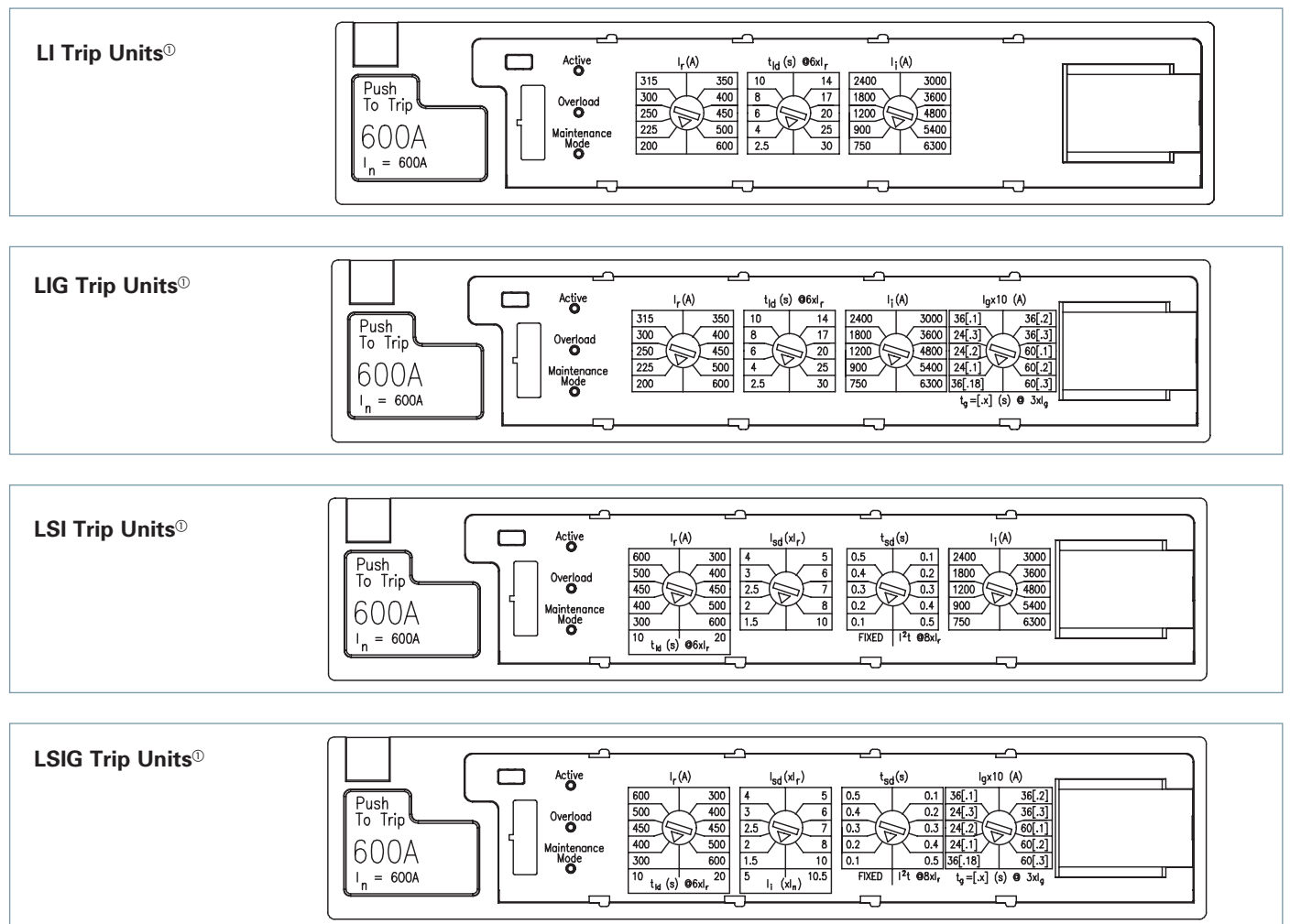

- $I_n$  = Maximum circuit breaker ampere rating
- $I_r$  = Continuous current rating expressed in amperes
- $I_i$  = Instantaneous pickup expressed in amperes
- $I_{sd}$  = Short time pickup expressed in multiples of  $I_r$

- $I_g$  = Ground fault pickup expressed in amperes
- $t_{sd}$  = Short time delay - either fixed or  $I^2t$  time delay function
- $t_{ld}$  = Long time delay -  $I^2t$  time delay function
- $t_g$  = Ground fault delay -  $I^2t$  time delay function

NOTE: Frame rating ( $I_n$ ) of 600A shown as an example. Trip unit settings will vary based on the specific frame rating ( $I_n$ ) of the device.

① Schematic of advanced trip unit shown. Basic trip units are identical but do not include DAS / Maintenance Mode functionality.

7  
MOLDED CASE  
CIRCUIT BREAKERS

# Molded Case Circuit Breakers

Digital Solid State Sentron Sensitrip IV Series

Technical

**A. Adjustable "Continuous Amps" Rating Switch**  
All Sensitrip IV solid state molded case circuit breakers have an adjustable ampere rating switch. Adjustments made to this switch change the continuous current rating of the breaker.

**B. Adjustable "Long Time Delay" Switch**  
All Sensitrip IV circuit breakers have an adjustable long time delay switch to allow for selection of long time delays of fixed time intervals at six times the setting of the adjustable "continuous amps" rating switch.

**C. Adjustable "Instantaneous Pick-Up" Switch**  
Sensitrip IV circuit breakers with an adjustable instantaneous pick up switch allow selection of a specific instantaneous trip setting.

**D. Adjustable "Short Time Pick-Up" Switch (Optional)**  
Sensitrip IV circuit breakers with an adjustable short time pick-up switch allow for selection of short time pick-up in a range from 1.5 to 10 times the setting of the maximum current rating.

**E. Adjustable "Short Time Delay" Switch (Optional)**  
Sensitrip IV circuit breakers with an adjustable short time delay switch also contain a switch for adjustment in time delay. The adjustable short time delay switch allows for either of two modes of short time delays. One range of settings enables the breaker to be set for fixed time delays and the other range of settings enables the breaker to be set for short time delays based on I<sup>2</sup>t curves.

**Adjustable "Ground Fault Pick-Up" Switch**  
Sensitrip IV circuit breakers containing the optional equipment ground fault protection have a ground fault pick-up setting. The ground fault pick-up settings allow for one of three time delays based on I<sup>2</sup>t curves.  
For 3-phase, 4-wire systems, an external neutral transformer is required with an ampere rating equal to the trip unit ampere rating.

**Legend:**  
 $I_n$  = Maximum circuit breaker ampere rating  
 $I_r$  = Continuous current rating expressed in amperes  
 $I_i$  = Instantaneous pickup expressed in amperes  
 $I_{sd}$  = Short time pickup expressed in multiples of  $I_r$   
 $I_g$  = Ground fault pickup expressed in amperes  
 $t_{sd}$  = Short time delay - either fixed or I<sup>2</sup>t time delay function  
 $t_{ld}$  = Long time delay - I<sup>2</sup>t time delay function  
 $t_g$  = Ground fault delay - I<sup>2</sup>t time delay function

## Examples of Adjustment Settings

### Catalog Number SLD6A600LI

	Frame Rating ( $I_n$ )	Switch 1 Continuous Current Setting ( $I_r$ )	Switch 2 Long Time Delay Setting ( $t_{ld}$ )	Switch 3 Instantaneous Pickup Setting ( $I_i$ )
<b>Setting</b>	600A	200	2.5	750
<b>Description</b>	600A max current rating	200A	2.5 sec to trip @ $6 \times I_r$ [ $6 \times 200A = 1200A$ ]	750A

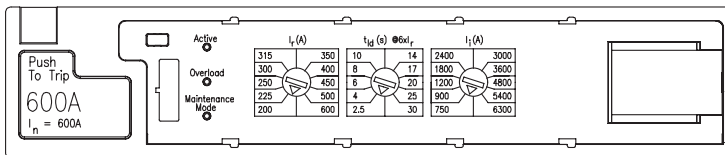

### Catalog Number SLD6A600LSIG

	Frame Rating ( $I_n$ )	Switch 1		Switch 2		Switch 3	Switch 4	
		Cont. Current Setting ( $I_r$ )	Long Time Delay Setting ( $t_{ld}$ )	Short Time Pickup Setting ( $I_{sd}$ )	Instantaneous Pickup Setting ( $I_i$ )	Short Time Delay Setting ( $t_{sd}$ )	Ground Fault Pickup Setting ( $I_g$ )	Ground Fault Delay Setting ( $t_g$ )
<b>Setting</b>	600A	300	10	1.5	5	0.1	36 [.18]	36 [.18]
<b>Description</b>	600A max current rating	300A	10 sec @ $6 \times I_r$ [ $6 \times 300A = 1800A$ ]	1.5 x $I_r$ [ $1.5 \times 200A = 300A$ ]	5 x $I_n$ [ $5 \times 600A = 3,000A$ ]	0.1 sec	$I_g = 36 \times 10$ [ $36 \times 10 = 360A$ ]	0.18 sec @ $3 \times I_g$ [ $3 \times 360 = 1,080A$ ]

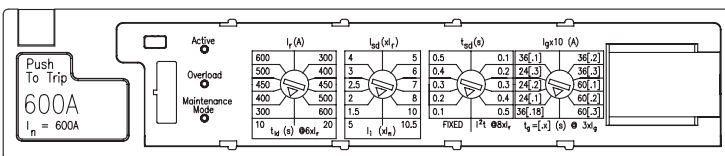

7  
MOLDED CASE  
CIRCUIT BREAKERS

## Breaker Description

The ever-increasing use of plant and energy management systems has intensified the demand for circuit breakers supporting multiple open protocols to monitor and control the flow of energy in the power system. The extensive and modular WL family of circuit breakers and accessories provides this for applications from 200A to 6000A.

### Applications

WL breakers can be applied as main, tie, feeder or distribution breakers in low-voltage electrical power systems.

### Versions

- Frame ratings: 800A to 6000A
- 3 physical frame sizes
- Rated nominal operating voltage up to 635VAC
- Seven interrupting classes from 50kA to 200kA at 480V
- Circuit breaker or non-automatic switch
- WL Circuit Breakers are delivered as complete assembled breakers or individual frames, guide frames, and accessories

### Installation Types

Fixed-mounted or Draw-out version.

### Standards

- WL ANSI / UL 1066 Circuit Breakers will satisfy: C37.13, C37.16, C37.17, C37.50, NEMA SG3
- WL UL 489 Circuit Breakers will satisfy: UL 489
- WL Circuit Breakers are suitable for use in UL 1558 LV Switchgear and UL 891 LV Switchboards

### Conditions of Application

WL Circuit Breakers are designed to meet standard Industrial and Commercial application requirements.

### Uniform Dimensions

WL Circuit Breaker dimensions differ only in the device width, which varies by frame size. With the exception of the 200kA ANSI Frame Size II which has an additional 5" in depth to accommodate integral fuses and the UL489 Frame Size I which measures only 15" in height to allow six-high stacking in switchboards.

### Minimal Space Requirements

The WL design is extremely compact without sacrificing performance and does not use energy-wasting heat sinks.

### Trip Units

The electronic, micro processor-based trip unit is auxiliary voltage-independent for all protective functions and enables adaptation to the different protection requirements of distribution systems, motors, transformers and generators.

### Non-Automatic Switch

A special version of the circuit breaker is used as a non-automatic switch.

The non-automatic switch is constructed without a trip unit and has no protective function. A possible application is for use as a tie in systems with parallel feeds.

### Main Bus Connectors

Breakers are equipped with standard vertical main bus connections. Horizontal bus connections are available as an option in Frame Size 1 and 2 up to 2000A.

### Communication Capability

MODBUS or PROFIBUS communications transmit the acquired and metered data, such as current values, breaker status, trip log, etc. to a central monitoring computer. With a factory installed metering function option, the WL acquires data useful for power management and can contribute to a significant savings in energy costs. A new, internal circuit breaker bus enables the expansion of breaker functionality through the integration of many secondary functions which were previously separate, including:

- Control of analog displays
- Options for testing the communication setup
- Display of breaker status and reason for trip
- Input modules for reading other external signals and transmitting these signals via PROFIBUS or MODBUS communication
- A selection of output modules to provide contact closures based on events or measured-value setpoints. It is not only possible to monitor the breaker remotely, it is also possible to open and close the breaker as well as setting parameters remotely

### Operating Mechanisms

Circuit breakers can be optionally delivered with different operating mechanisms, including:

- Manual operating mechanism with mechanical closing (standard)

- Manual operating mechanism with mechanical and electrically interlocked closing
- Motorized operating mechanism with mechanical and electrically interlocked closing. Operating mechanisms with electrically interlocked closing are suitable for synchronizing tasks

### Auxiliary Contacts

Auxiliary switches can be added according to the type of installation. They are easily mounted via front, top mounted terminal blocks.

### Modularity

Common guide frames for the draw-out version make them completely interchangeable between the UL 489 and ANSI / UL 1066 rated circuit breakers. Components, such as auxiliary releases, motorized operating mechanisms, trip units, current sensors, auxiliary signal switches, automatic reset devices or interlocks can be used to modify or retrofit any circuit breaker to meet changing requirements. The main contacts can be replaced to extend the life of the circuit breaker and feature integrated contact wear indicators.

### Electronic Trip Unit Modularity

Modularity is the outstanding feature of the new WL Circuit Breakers. The trip units themselves can be retrofitted with special LCDs, ground fault modules, rating plugs and communication modules. 100% Rated Circuit Breaker WL circuit breakers are designed for continuous operation at 100% of their current rating without the need for external heat sinks.

### Conditions of Application

WL Circuit Breakers are designed to meet standard Industrial and Commercial application requirements.



# WL Power Circuit Breakers

Communication Information

General

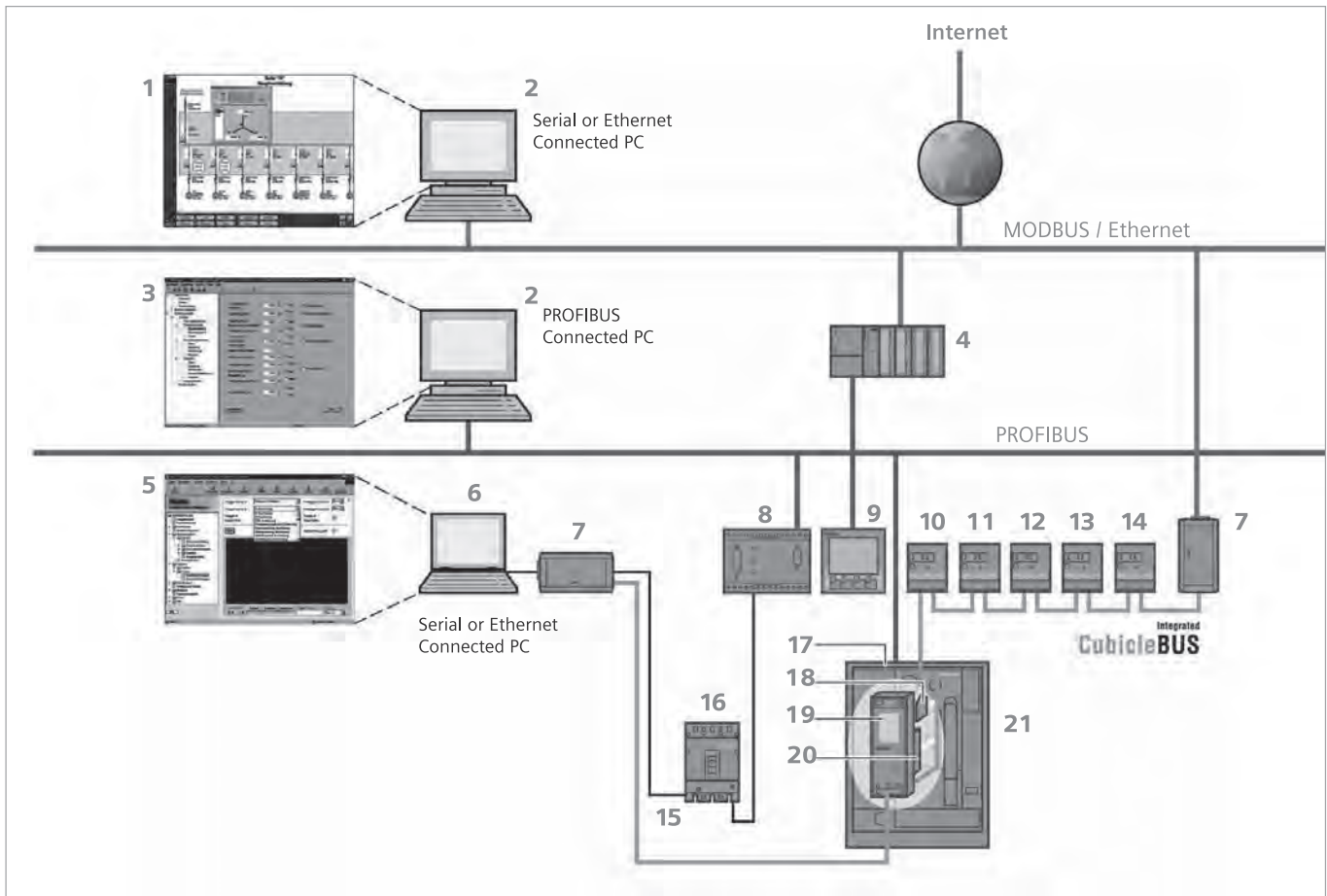

7  
MOLDED CASE  
CIRCUIT BREAKERS

## A spectrum of power distribution communication

- |   |  |
|---|--|
| <ul style="list-style-type: none"> <li>1 WinPM.Net software</li> <li>2 Server or desktop PC</li> <li>3 Switch ES power software</li> <li>4 PLC</li> <li>5 BDA web server</li> <li>6 Portable PC</li> <li>7 Breaker data adapter (BDA)</li> <li>8 COM10 PROFIBUS module or COM11 MODBUS module</li> <li>9 Power metering device</li> <li>10 Zone selective interlock</li> <li>11 Digital input module</li> </ul> | <ul style="list-style-type: none"> <li>12 Analog output module</li> <li>13 Digital output module</li> <li>14 Relay output module</li> <li>15 VL CubicleBus network</li> <li>16 VL feeder breaker</li> <li>17 Input power and communication terminals</li> <li>18 Breaker status sensor (BSS)</li> <li>19 Trip unit display</li> <li>20 Metering function</li> <li>21 WL power breaker</li> </ul> |
|---|--|

# WL Power Circuit Breakers

## Electronic Trip Units

General



### Trip Unit Functions

Basic Protective Functions		ETU745	ETU748	ETU776
Long-time overcurrent protection	L	●	●	●
Short-time delayed overcurrent protection	S	●	●	●
Instantaneous overcurrent protection	I	●	●	●
Neutral conductor protection	N	●	●	●
Ground fault protection	G	○	○	○
Additional Functions				
Selectable neutral protection		●	●	●
Defeatable short-time protection		●	—	●
Defeatable instantaneous protection		●	—	●
Selectable thermal memory		●	●	●
Zone selective interlocking		●	●	●
Selectable I2t or fixed short-time delay		●	●	●
Adjustable instantaneous pick-up		●	—	●
Selectable I2t or I4t long-time delay		●	●	●
Adjustable short-time delay and pick-up		●	●	●
Selectable and adjustable neutral protection		●	●	●
Dual protective setting capability		—	—	●
Dynamic arc-flash sentry		—	—	●
Extended instantaneous protection		●	●	●
Parameterization and Displays				
Parameterization by rotary switches (10 steps)		●	●	—
Parameterization by communication (absolute values)		—	●	●
Parameterization by menu/keypad (absolute values)		—	—	●
Remote parameterization of the basic functions		—	—	●
Remote parameterization of the additional functions		—	—	●
Alphanumeric LCD		○	○	—
Graphical LCD		—	—	●
Metering Function				
Metering function		○	○	○
Metering function Plus		○	○	○
Communication				
CubicleBUS		●	●	●
Communication via PROFIBUS-DP		○	○	○
Communication via the MODBUS		○	○	○
Communication via the Ethernet (BDA)		○	○	○

● Standard    — Not available    ○ Optional

## Rating Plug

It is no longer necessary to replace the current transformer to change the rated current of the breaker. Instead, you simply replace the rating plug which is easily accessible on the front of the trip unit. The circuit breaker is set to the new rated current quickly and is already correctly labeled.

## Long Time Overcurrent Protection with Switchable I2t/I4t Characteristics

The long time overcurrent protection in the ETU745, ETU755 and ETU776 trip units can be switched between an I2t and I4t characteristic to improve coordination between upstream circuit breakers and fuses.

## Front Panel

The front panel is designed so that it can be accessed through a cutout in the door, which means that all controls and displays are accessible even when the cubicle door is closed. The front panels of all Frame Size II and Frame Size III circuit breakers are identical, and allow for two different through-door access designs: Trip unit and front panel controls or front panel controls only. The degree of protection of the front panel is IP 20.

## Environmental Protection

The plastics used are halogen-free and recyclable.

## Safety and Reliability

In order to help protect the electrical distribution system and circuit breaker against unauthorized breaker operations,

a wide range of locking devices can be installed or retrofit, including:

- Lockable drawout version to protect against unauthorized removal (standard)
- High degree of protection through Plexiglas cover
- Mechanical reclosing lockout after long-time, short-time or instantaneous trip (optional)
- Devices with trip unit ETU745 or higher are equipped with temperature sensors on the BSS and COM15/COM16 (standard)
- Lock provision for locking the breaker in the OPEN position
- Lockable covers for the CLOSE button
- Lockable racking handle prevents moving the breaker
- Lockable charging handle prevents charging the springs

## Standard Version Features

WL Circuit Breakers have the following standard equipment:

- Mechanical CLOSE and mechanical OPEN push buttons
- Manual operating mechanism with mechanical closing
- Contact position indicator
- Front panel ready-to-close indicator

- Spring charge indicator
- Rear vertical main contacts
- Main contact replacement flag
- Auxiliary plug system with bare wire pressure screw terminals. Delivery includes all auxiliary plugs necessary for both factory installed and future field installed accessories
- Mechanical trip indicator of the overcurrent release system
- Automatic reset after trip
- The front panel cannot be removed if the circuit breaker closed
- Laminated main contact fingers as part of the breaker contact strip on the drawout circuit breaker
- Breaker position display in the operator's panel
- Captive crank handle for racking out the breaker
- Guide frame with guide rails for easy handling of draw-out version
- Breaker cannot be moved in the CLOSED state
- Rated current coding between the guide frame and the breaker
- Suitable for reverse feed applications
- The breaker is always equipped with the required number of secondary disconnect blocks

## Exclusive Features

### Generator/Utility Protection Sets

24/7/365 power availability is critical for some systems. On-site generation capability is growing more and more common in many systems. All of the WL digital electronic trip units allow the system designer to precisely tailor trip settings for the most demanding requirements. However, the 776 trip unit allows one set of trip settings for a fully loaded utility feed and with a simple contact closure, the trip unit toggles to a second trip set tailored to provide optimal generator protection. The wide range of settings allows the WL to provide protection for a minimal generator capacity for only essential loads, through full backup for an entire facility. This dual utility/generator protection capability in a single circuit breaker allows the system designer unparalleled, cost effective, flexibility.

### Dynamic Arc-Flash Sentry

A unique feature of the WL trip unit allows the system designer to achieve lower levels of arc flash energy and delayed tripping for selective trip coordination purposes.

Dynamic Arc-Flash Sentry (DAS) employs the unique dual protective setting capability of the 776 trip unit, coupled with the ability to easily toggle to a lower arc flash parameter set. A normal operation parameter set can be optimized for selective trip coordination, while the second set is optimized for lower arc flash energy levels. The dynamic action comes from the ability to switch from the normal operation set to the arc flash limiting set based on the presence of personnel as they approach the flash protection boundary. A wide variety of switching methods may be used based on the needs of a particular facility. The capabilities range from fully automatic switching using appropriate occupancy sensors to manual switching via a key operation.

### Extended Instantaneous Protection

Extended Instantaneous protection (EIP), another unique feature of the WL trip unit, allows the system designer to achieve full selective trip coordination up to the short-time rating of the frame while also allowing application of the breaker up to the interrupting rating of the frame. The typical power circuit breaker with an 'LS' trip unit, or when

the instantaneous function is switched off on an 'LSI' trip unit, can only be applied up to its short-time rating, commonly 85kA or less. For application on systems with levels of available fault current above the short-time rating, the typical 'LS' power circuit breaker cannot be applied or must employ an instantaneous override. This instantaneous override is set at as much as 20% below the short-time rating and can seriously compromise selective trip coordination with downstream breakers.

The WL, equipped with EIP, overcomes these limitations by providing full withstand capability, and full coordination, with a minus 0% short-time band tolerance up to 85kA on frame Size II and 100kA on Size III. Above fault currents of 20% higher than the full short-time rating, the WL breaker is self-protecting, and the EIP function will trip the breaker instantly to protect the frame and the system from these extremely high currents, as high as 150kA on frame Size III. One added benefit is that arc flash energy is greatly reduced in this high current region due to the instantaneous trip response that EIP provides.

# Lug Information

For Use With Type(s)	Circuit Breaker Ampere Rating	Cables Per Lug	Lug Wire Range	Catalog Number
BQ, BQH, BQHF, BQE, BQF, BL, BLH, HBL, HBQ, Switching Neutrals, BG, BLG	<b>Line Side</b>			
	15-40	1 1	#14-#6 AWG Cu #12-#6 AWG Al	TC1Q1 <sup>①②</sup>
	45-125	1 1	#8-#1 AWG Cu #6-#1/0 AWG Al	TA1Q1 <sup>②</sup>
	<b>Load Side</b>			
	15-20	1 1	#14-#10 AWG Cu #12-#10 AWG Al	Lugs are integral to Circuit Breaker
	25-35	1 1	#14-#6 AWG Cu #12-#6 AWG Al	Lugs are integral to Circuit Breaker
	40-50	1 1	#8-#6 AWG Cu #8-#4 AWG Al	Lugs are integral to Circuit Breaker
	55-70 *exceptions in Table A	1 1	#8-#4 AWG Cu #8-#2 AWG Al	Lugs are integral to Circuit Breaker
	80-100	1 1	#4-#1/0 AWG Cu #2-#1/0 AWG Al	Lugs are integral to Circuit Breaker
	110-125	1 1	#2-#1/0 AWG Cu #1/0-#2/0 AWG Al	Lugs are integral to Circuit Breaker
BQD, CQD, BQD6, CQD6	<b>Line Side (CQD, CQD6) &amp; Load Side</b>			
	15-40	1	#14-#6 AWG Cu #12-#6 AWG Al	Integral
	45-100	1	#8-#1 AWG Cu #6-#1/0 AWG Al	Integral
NGG, HGG, LGG	15-30	1	#14-#6 AWG Cu #12-#6 AWG Al	TC1Q1
	15-30	1	#14-#6 AWG Cu #12-#6 AWG Al	3TC1Q1 (pkg. of 3)
	35-125	1	#8-#1/0 AWG Cu #8-#2/0 AWG Al	3TC1GG20 (pkg. of 3)
	15-125	—	NUT KEEPER PLATE	TNKG3 <sup>③</sup> (pkg. of 3)
NEG, HEG	15-125	1	#14-3/0 AWG Cu	3TW1EG30 (pkg. of 3)
	15-125	1	#14-1/0 AWG Cu/Al	3TA1EG10 (pkg. of 3)
	15-125	1	#6-3/0 AWG Cu/Al	3TA1EG30 (pkg. of 3)
	15-125	—	Nut Keeper Kit (3-pole)	TNKE3 (pkg. of 3)
	15-125	—	Nut Keeper Kit (4-pole)	TNKE4 (pkg. of 4)

Connector wire ranges and cavities are established in conjunction with Table 6.1.4.2.1 of UL 489 standards.

**Table A**

For Use With Type(s)	Circuit Breaker Ampere Rating	Cables Per Lug	Lug Wire Range	Number of Poles
<b>Load Side</b>				
BQ, BL, QP	55-60	1	#8-#4 AWG Cu-Al #3 AWG requires 22 or 65 kAIC	This exception is applicable to 1- and 2-pole only

**Note:**

(A) Molded case circuit breakers having a rated ampacity of 125 amperes or less are to be connected with 60 or 75°C wire. Circuit breakers having a rated ampacity greater than 125 amperes shall only be cabled with 75°C cable unless otherwise indicated on the circuit breaker label. Exceptions to this rule are outlined in article 110-14 C(1)(2) of the 2005 National Electrical Code.

(B) Connector wire ranges and cavities are established in conjunction with Table 6.1.4.2.1 of UL 489 standards.

- ① Lug is steel.
- ② Sold in package of six.
- ③ One nut keeper plate is required with each lug on the NGG breaker.

## Lug Information

## Aluminum Body Lugs for Copper or Aluminum Wire

Selection

For Use With Type(s)	Circuit Breaker Ampere Rating	Cables Per Lug	Lug Wire Range	Catalog Number
QR2, QR2H, HQR2, HQR2H	100-250	1	#3-300 Kcmil Al/C	3TA1QR300 (3 lugs per kit)
All 2, 3-pole ED2, ED4, ED6, ED6 ETI, HED4, HHED6	15-25	1	#14-#10 AWG (Cu) #12-#10 AWG (Al)	SA1E025
	30-100	1	#10-#1/0 (Cu or Al)	LN1E100
	110-125	1	#3-3/0 (Cu) #1-2/0 (Al)	TA1E6125
CED6 All 1-pole ED, HED	30-60	1	#10-4 (Cu or Al)	LD1E060 (Load Side)
	70-100	1	#4-#1/0 (Cu or Al)	LD1E100 (Load Side)
FXD6-A, FD6-A, HFD6, CFD6 HHFD6	70-250	1	#6 AWG-350 kcmil (Cu) #4 AWG-350 kcmil (Al)	TA1FD350A
SJD6-B, SHJD6-B SCJD6-B	65-200	1-2	#4 AWG-3/0 (Cu or Al)	TA2J630
JXD2(A), JXD6(A), JD6(A), SJD6-B, HJD6(A), HJXD6(A) HHJXD6, HHJD6, SHJD6-B, CJD6, SCJD6-B	200-400	1-2	3/0-500 kcmil (Cu) 4/0-500 kcmil (Al)	TA2J6500
LXD6(A), LD6(A), SLD6-B, HLD6(A), HLXD6(A), HHLXD6, HHL6, SHLD6-B, CLD6, SCLD6-B	250-600	1-2	3/0-500 kcmil (Cu) 4/0-500 kcmil (Al)	TA2J6500
LMD6 <sup>①</sup> , LMXD6 <sup>①</sup> , HLM6 <sup>①</sup> , HLMXD6 <sup>①</sup> , MD6, MXD6, SMD6-B, HMD6, HMXD6, SHMD6-B, CMD6, SCMD6-B	500-600	1-2	#1-500 kcmil (Cu or Al)	TA2K500
		1-3	1/0-500 kcmil (Cu or Al)	TA3K500
	500-800	1-2	500-750 kcmil (Cu or Al)	TA2N750 <sup>②</sup>
ND6, NXD6, SND6-B, HND6, HNXD6, SHND6-B, CND6, SCND6-B	800-1200	1-4	250-500 kcmil (Cu or Al)	2TA4P8500 <sup>③</sup> 3TA4P8500 <sup>④</sup>
			250-500 kcmil (Cu or Al)	2TA4N8500 <sup>③</sup> 3TA4N8500 <sup>④</sup>
PD6, HPD6, CPD6 PXD6, HPXD6, SPD6-B, SHPD6-B	1200-1600	1-5	300-600 kcmil (Cu or Al)	TA5P600
PD6, PXD6, HPD6, HPXD6, SPD6-B, SHPD6-B, RD6, RXD6, HRD6, HRXD6, STD	1200-2000	1-6	300-600 kcmil (Cu or Al)	TA6R600

① Use TA2K500 or TA3K500 only.  
 ② Used for 100% rated MD/ND frame breakers.  
 Rated for 90° C cable.

③ Contains 2 connectors plus 1 NDTs end barrier.  
 ④ Contains 3 connectors plus 1 NDTs end barrier.



# Lug information

## Optional Mechanical Lugs

Selection

For Use With Type	Circuit Breaker Ampere Rating	Cables Per Lug	Lug Material	Lug Wire Range	Qty Per Catalog No	Catalog Number
QR2, QR2H, HQR2, HQR2H	100-250	1	Cu	#3 - 300 Kcmil Cu ONLY)	3	3TC1QR2520 (3 lugs per kit)
ED, HED 1, 2 & 3-pole	1, 2 & 3-pole 30-125	1	Cu	#10-#1/0 (Cu)	1	TC1ED6150
HFD6, HHFD6, CFD6, F(X)D6-A	70-250	1	Cu	#6 AWG-350 kcmil (Cu)	1	TC1FD350
J(X)D2(A), J(X)D6(A), HJD6(A), HHJD6, SHJD6-B, L(X)D6(A), HHL6, SCD6-B, HLD6(A), SHLD6-B, CJD6, CLD6, SCJD6-B, SCLD6-B	200-600	1 1-2	Cu	3/0-600 kcmil (Cu) 3/0-500 kcmil (Cu)	1 1	TC1J6600 <sup>①</sup> TC2J6500 <sup>①</sup>
	250-600	1 1	Al	500-750 kcmil (Al) 500-600 kcmil (Cu)	1	TA1L6750
SMD6-B, M(X)D6, HM(X)D6, HMD6,	500-600	1-2	Cu	#1 AWG-500 kcmil (Cu)	1	TC2K500
		1-3	Cu	#1 AWG-350 kcmil (Cu)	1	TC3K350
CMD6, SCMD6-B, SND6-B, N(X)D6, HN(X)D6,	700-800	1-2	Al	500-750 kcmil (Cu)	2	2TA2N8750
				500-750 kcmil (Al)	3	3TA2N8750
SHND6-B, CND6, SCND6-B	800-1200	1-3	Al	500-750 kcmil (Cu)	2	2TA3N8750
				500-750 kcmil (Al)	3	3TA3N8750
R(X)D6, HR(X)D6	1600-2000	1-5	Cu	300-600 kcmil (Cu)	1	TC5R600
P(X)D6, HP(X)D6, CPD6, SPD6-B, SHPD6-B	1200-1600	1-4	Al	600-750 kcmil (Cu/Al)	1	TA4P750▲

## Compression Lugs

For Circuit Breaker Types	Ampere Rating	Poles	Lugs Per Kit	Lug Wire Size	Catalog Number
Lugs (contains indicated number of lugs and necessary hardware per kit)					
ED2, ED4, ED6, HED4, HHED6, CED6	15-125	1, 2, 3	1	#2/0 AWG Cu/Al	CCE125
QR2, QR2H, HQR2, HQR2H	100-250	2-3	1	#6 - 350kcmil Al/Cu	CCQ250
F(X)D6-A, HF(X)D6, HHF(X)D6, CFD6	125-250	2, 3	1	350 kcmil	CCF250
JXD2-A, J(X)D6-A, HJ(X)D6-A, HHJ(X)D6-A, CJD6, SJD6-B, SHJD6-B, SCJD6-B, L(X)D6-A, HL(X)D6-A, CLD6, SLD6-B, SHLD6-B, SCLD6-B	200-600	2, 3	1	500 kcmil	CCL600
Kits (contain lugs and hardware for complete line or load end of 2 or 3-pole breaker)					
M(X)D6, HM(X)D6, CMD6, SMD6-B, SHMD6-B, SCMD6-B	500-800		2	500 kcmil	CCM800K2
			3		CCM800K3
N(X)D6, HN(X)D6, CND6, SND6-B, SHND6-B, SCND6-B	900-1200		2	500 kcmil	CCN1200K2
			3		CCN1200K3

## Distribution Lugs<sup>②</sup>

For Circuit Breaker Types	Ampere Rating	Poles	Lugs Per kit	Wires Per Lug	Lug Wire Size	Catalog Number
NGG, HGG, LGG	15-125	1,2,3	1	6	#6-#4 AL #14-#4 Cu	TA6GG04
NEG, HEG	15-125	1,2,3	3	3	#14-#2 AWG Cu	3TA3EG02
NEG, HEG	15-125	1,2,3	3	6	#14-#6 AWG Cu	3TA6EG06
ED2, ED4, ED6, HED4, HHED6, CED6	15-125	1,2,3	1	6	#14-#4 AWG Cu #6-#4 AWG Al	TA6ED06
F(X)D6-A, HF(X)D6, HHF(X)D6, CFD6	70-250	2,3	1	6	#14-#4 AWG Cu #6-#4 AWG Al	TA6FD04
JXD2-A, J(X)D6-A, HJ(X)D6-A, HHJ(X)D6-A, CJD6-A, SJD6-B, SHJD6-B, SCJD6-B, L(X)D6-A, HL(X)D6-A, CLD6-A, SLD6-B, SHLD6-B, SCLD6-B	200-600	2,3	1	6	#14-2/0 AWG Cu #6-2/0 AWG Al	TA6JD20

▲ Built to order. Allow 6-8 weeks for delivery.

① Used for 100% rated JD/LD frame circuit breakers.

② Special purpose wire connectors, not for general use.

# Molded Case Circuit Breakers

## Modifications

## General/Selection

A variety of internal and external accessories, as well as modifications, are available to adapt Siemens circuit breakers to special installation requirements. UL listed internal accessories for 100 through 2000A circuit breakers are field-addable.

Internal accessories fine tune an electrical distribution system, allowing control of the circuit breakers to meet special application requirements. For example, emergency situations may dictate tripping critically placed circuit breakers quickly. Shunt trips accomplish this conveniently and efficiently. Or, when voltage drops are a concern, undervoltage trips automatically open the circuit breaker at a predetermined voltage level.

A wide range of external operating and mounting accessories is also available. For example, face, shallow, and back mounting plates are ideal for tailoring BQ circuit breakers to OEM applications. A complete line of operating handles and handle-blocking devices meet switchboard, enclosure and safety needs. Plug-in mounting assemblies, which simplify switchboard mounting of circuit breakers and permit breaker removal without disconnecting bus or cable connections, are available.

**50°C Ambient Calibration — Not UL listed and not available for solid state, 100% rated breakers or 400HZ calibrated breakers.**

- For BL Type Circuit Breakers
  - Add suffix 'M' to catalog number (Example: B120M).....No Charge
- For BQ and ED Frame Circuit Breakers
  - Replace 'B' in catalog number with 'M' .....No Charge (Example: BQ3M060, ED63M060)
- For FD, JD, LD, LMD, MD, ND, PD, and RD Frame Circuit Breakers
  - Non-Interchangeable Trip (3-pole only) .....No Charge
  - Replace 'B' in catalog number with 'M' (Example: FXD63M225, JXD63M400)

**400 HZ Calibration**

- UL Listed (5KA IR)
- For BQ & BL Type Circuit Breakers (200A max.).....Add 25% to list price
  - Add suffix 'Y' to catalog number
- Not UL Listed
- For all other Circuit Breakers, see derating tables on page 7-149 and order standard circuit breakers.

**Fungus Proofing**

- All BQD, CQD, GB, GG, ED, FD, JD, LD, LMD, MD, ND, PD, RD, DG, FG, JG, LG, MG, NG, and PG Frame Circuit Breakers are inherently fungus resistant and do not require special treatment.
- For BL, and BQ Type Circuit Breakers.....Add \$10.00 net per pole
  - Consult Sales Office for Availability
- For all other Circuit Breaker Types.....Add \$160.00 net per device
  - Consult Sales Office for Availability

**Certificate of Compliance with Test Report (catalog number CERT OF COMP.)** Add \$210.00 net  
 Certificate of compliance testing must be performed on the actual device being shipped. The certificate cannot be provided after initial shipment. Order for devices with COC requirement must be placed directly with the factory by the sales office and shipped directly to the end user.

## UL 489 Supplement SB Naval Use Breakers

Breakers tested to UL 489 Supplement SB are qualified for use on non combat and auxiliary naval vessels.

Various Siemens molded case breakers can be labeled "NAVAL" in compliance with UL 489 Supplement SB. See table to the right for specific breaker types and UL file references.

Supplement SB testing comprises two sets of vibration tests. The first is to find mechanical resonances in the product and to subject the breaker to extreme testing at each resonant frequency. The second is a swept frequency test, in which the frequency of excitation is changed in intervals of 1Hz, and held at each frequency for five minutes. The excitation frequencies run from 4 to 33Hz, and the test is conducted in each of the three orthogonal axes of the breaker.

During these tests, the breaker must not trip from the closed position, nor may the contacts touch from the open position. Calibration and insulation resistance are also verified during the test.

For detailed information, refer to UL 489, Supplement SB.

### Ordering Information

For "NAVAL" label, add **\$75.** net per catalog number per order. Order must be placed directly with the factory by Siemens Sales Office.

Breaker Type	UL File
BL	E82615, Vol 1, Sec 1 & 4
NGB	E10848, Vol 10, Sec 3
CED6	E10848, Vol 4, Sec 13
HED4, ED6	E10848, Vol 4, Sec 11
FXD6, HFD6, HHFD6	E10848, Vol 4, Sec 17
HHJD6	E10848, Vol 4, Sec 20

# Molded Case Circuit Breakers

## Feature Combinations

The available feature combinations are shown in the chart below. For applications requiring combinations of features not listed in this chart, consult the sales office for availability.

Breakers	Modules Per Breaker	Avail. On Breaker Poles	ST	ST/AUX	ST/ALSW	ST/AUX/ALSW	UVT	UVT/AUX	UVT/ALSW	UVT/AUX/ALSW	AUX	AUX/ALSW	ALSW	Elect. Bell Alarm	Ground fault	Grd fault w/Bell
QP, BQ, BL <sup>①</sup>	1	1, 2, 3	1	—	—	—	—	—	—	—	1,2	—	—	—	—	—
BQD, CQD, GB, GG	1	2, 3	1	1/1	—	—	—	—	—	—	1,2	1/1	1	—	—	—
QR	1, 2	2, 3	1	1/1	—	—	—	—	—	—	2	—	—	—	—	—
All ED	1	1, 2, 3	1	1/1,1/2	1/1	1/1/1	1	1/1, 1/2	1/1	1/1/1	1, 2	1/1, 2/1	1	—	1	1
All FD	2	2, 3	1	—	—	—	1	1/1	—	—	1, 2	1/1	1	—	—	—
All JD, LD, LMD <sup>②</sup>	2	2, 3	1	1	—	—	1	1/1, 1/2	—	—	1, 2	1/1, 1/2	1, 2	—	—	—
SJD, SHJD, SCJD,SLD, SHLD, SCLD <sup>③</sup>	1	3	1	1	—	—	1	1/1, 1/2	—	—	1, 2	1/1, 1/2	1, 2	—	—	—
All MD, ND, PD, RD Including Electronic trip <sup>④</sup>	2	2, 3	1	1/1	—	—	1	1/1, 1/2	—	—	1, 2	1/1, 2/1	1, 2	—	—	—
STD <sup>⑤</sup>	6	3	1	—	—	—	1	—	—	—	1 NC / 1 NO, 2 NC / 2 NO, 3 NC / 3 NO, 4 NC / 4 NO, 5 NC / 5 NO, 6 NC / 6 NO	—	1	1	—	—

### Shunt Trip (ST)

One or all critical circuit breakers may be tripped from a distant control point by use of a shunt trip device. A shunt trip operates through an auxiliary switch contact; when the breaker opens, current is not maintained on the shunt trip coil.

### Undervoltage Trip (UVT)

When voltage drops to a value below 35% of the nominal coil rating, the undervoltage trip device automatically opens the breaker. The operation is instantaneous, and the circuit breaker cannot be reclosed until the

voltage returns to 85% of line voltage. The undervoltage trip, which is continuously energized, must be energized before the circuit breaker can be closed.

### Auxiliary Switch (AUX)

For applications requiring remote “on” or “off” indication (or electrical interlocking), auxiliary switches are available. Each switch comprises an “A” (open when circuit breaker is open) and a “B” (closed when circuit breaker is open) contact with a common connection. (Form C)

### Alarm Switch (ALSW)

The alarm switch contact is closed when the circuit breaker is opened automatically by an overload, short circuit, shunt trip or undervoltage trip. The alarm switch contact is open when the circuit breaker is reset.



For ED Frames



For FD Frames



For JD and LD Frames

①Factory assembled only

②If mechanical interlock is installed, no accessory module can be installed in the right pocket.

③If mechanical interlock is installed, no accessory module can be installed.

④If mechanical interlock is installed, no accessory module can be installed in the left pocket.

⑤One module per column.

# Circuit Breakers

## Circuit Breaker Accessories

### Circuit Breaker Accessories ④⑤⑥⑦⑧⑨

Catalog Number	For Use With Breaker Type	Number of Poles	Standard Package
<b>Padlocking Device</b> For locking breaker in "OFF" position. Note "ON" position does not affect breaker functionally			
ECPLD1	Type QP, BL, QAF2, QPF2, QE, QT-Duplex, BQ, BQXD	1P	3 Pieces
ECPLD1R	Type QP, BL, QAF2, QPF, QE, QT-Duplex, BQ, BQXD (Red Color)	1P	3 Pieces
ECPLD2	Type QP, BL, QAF2, QPF, QE, QT-Triplex & Quadplex, BQ, BQXD	2P	3 Pieces
ECPLD2R	Type QP, BL, QAF2, QPF, QE, QT-Triplex & Quadplex, BQ, BQXD (Red Color)	2P	3 Pieces
ECPLD3	Type QP, BL, QAF2, QPF, QE, BQ	3P	1 Piece
US2:ECPLD3R	Type QP, BL, QAF2, QPF, QE, BQ (Red Color)	3P	1 Piece
ECQLD3	Type QP, BL, BQ, BQXD	1P	10 Pieces
ECQLD4	Type QT-Duplex	QT-Duplex Breakers	10 Pieces
ECQLN3 <sup>②</sup>	150-225 MBKA, QN, QNR	n/a	1 Piece
ECQTH4	Type QP, BL, BQH	Designed for (3) 1P Breakers	1 Piece
<b>Handle Tie</b> Provide simultaneous swiching of 2 adjacent handles.			
ECQTH2	Type QT Duplex	Designed for (2) QT Duplex Breakers	25 Pieces
ECQTH3	Type QP, BL	2P	50 Pieces
<b>Mechanical Interlock<sup>①</sup></b>			
ECQML12	Type QP, BL, BQ Interlock Bracket	Designed for 1" Breaker	10 Pieces
<b>Handle Blocking Device</b> For holding breaker in "ON" or "OFF" position. Not a lockout/tagout device			
ECQTH2	Type QP, BL, BQ, BQXD	1P	10 Pieces
ECQTH3	Type QT-Duplex	1/2" Breakers	10 Pieces
<b>Main Breaker Retainer</b>			
ECMBR1 <sup>③</sup>	EQ Load Centers		1 Piece
ECMBR2	Ultimate Load Centers		1 Piece
<b>Mounting Accessories</b>			
MB120	Type BQ, BQH Mounting Clips	1P	20 Pieces
FP9508	Type BQ, BQH FACE MOUNT PLATE	1P	10 Pieces
FP9555	Type BQ, BQH FACE MOUNT PLATE	2P	10 Pieces
FP9556	Type BQ, BQH FACE MOUNT PLATE	3P	10 Pieces
SMB6R	Type BQ MOUNTING BRACKET	1P, 2P, 3P	6 Pieces
TCH65K	Type BQ MOUNTING ADAPTER		500 Pieces
BR2	Type BQ, BQH, BQXD Back Mounting Plates	2P	10 Pieces
BR3	Type BQ, BQH, BQXD Back Mounting Plates	3P	10 Pieces
BR4	Type BQ, BQH, BQXD Back Mounting Plates	4P	10 Pieces
I0204ML1125CU	Type QP Back Mounting Plates	1P, 2P	10 Pieces
I0303ML3100CU	Type QP Back Mounting Plates	3P	10 Pieces
<b>Replacement Lugs</b>			
TA1Q1	Type BQ, NGG 100A AI Cu LGS	n/a	6 Pieces
TC1Q1	Type BQ, NGG 40A AI Cu LUGS	n/a	6 Pieces
<b>Finger Shield</b>			
BQFS1K	Type BQXD Finger Shield (Bulk Pack)	n/a	1000 Pieces
BQFS2	Type BQXD Finger Shield	n/a	2 Pieces
<b>Filler Plate</b>			
ECQF3	1" Filler Plate	n/a	5 Pieces

① For a complete list of standby power mechanical interlock kits, see page 1-25

② For use with Ultimate Load Center Main Breakers

③ Not suitable for use on 15-50A, 10 AIC Type QP Circuit Breakers

④ QP Type includes QPH, HQP

⑤ BL Type includes BLH, HBL

⑥ BQ Type includes BQH, HBO

⑦ QAF2 Type includes QAFH2, BAF2, BAFH2, QFGA2, QFGAH2, BFGA2, BFGAH2

⑧ QPF Type includes QPHF, BLF, BLHF

⑨ QE Type includes QEH, BLE, BLEH

## Padlocking Device



ECPLD1

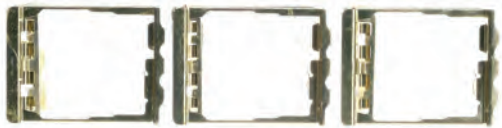

ECPLD2



ECPLD1R/2R/3R (Single pole pictured. 2-/3-pole available)



ECQLD3

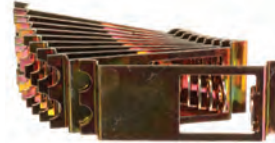

ECQLD4



ECQTH4

## Handle Tie



ECQTH2



ECQTH3

## Handle Blocking Device

ECQL1



ECBX231M



## Main Breaker Retainer



ECMBR1



ECMBR2

## Mechanical Interlock

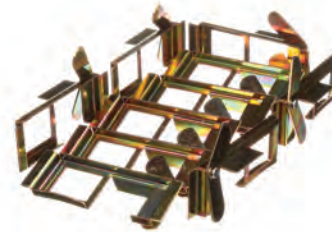

ECQML12

## Mounting Accessories



MB120



SMB6R



I0204ML1125



FP9508



FP9555



FP9556

# Molded Case Circuit Breakers

## External Accessories

Selection

### Handle Ties with Padlock Device

Provide simultaneous switching of 2 or 3 adjacent handles.  
Do not provide common trip.

For Use With Breaker Frame(s)	Catalog Number	Standard Package	Wt Lb/Std Pkg
BQD, NGB, HGB, LGB	BQDHT2	10	½
	BQDHT3	10	½

### Padlocking Devices

For locking breaker in "OFF" position.

All QR	HPLQR	1	¼
All BQD, CQD, NGB, HGB, LGB	BQDPLD	1	⅞
NGG, HGG, LGG	HPLG	1	¼
EB, 1- thru 3-pole	HPLEB	1	⅞
EG, 3- and 4-pole only	HPLE	1	¼
All ED	ED2HPL	1	¼
All FD	FD6PL1	1	¼
All JD, LD, LMD	JD6HPL	1	¼
All MD, ND, PD, RD	MN6PLD	1	¼



### Handle Blocking Devices

For holding breaker in "ON" or "OFF" position.  
Not a lockout/tagout device.

All QR	HBLQR	1	1
All BQD, CQD, GG, GB	BQDHBD	1	¼
EG	HBDE	1	¼
All ED	E2HBL	1	¼
All FD	FD6HB1	1	½
All JD, LD, LMD	JD6HBL	1	½
All MD, ND, PD, RD	MN6BL	1	½



### Handle Extensions

For replacement. One extension shipped with breaker.

All MD, ND, PD, RD	EX11	1	2
--------------------	------	---	---



### Terminal Shields

Breaker Type	Poles	Catalog Number	Standard Package
NGG	3	TSSG3A	1
	1	TSSG61	1
HGG, LGG	2	TSSG62	1
	3	TSSG63	1
JD, LD	3	JDTERMSHIELD	1
MD, ND, PD, RD	3	MDTERMSHIELD	1

■ Built to order. Allow 2-3 weeks for delivery.

Ⓞ Sold only in standard package quantities.

# Molded Case Circuit Breakers

## Face Mounting Plates

For Use With Breaker Frame(s)	Number of Poles	Catalog Number	Standard Package	Wt Lb/Std Pkg
CQD, CQD6	1	CQDFMB1	1	¼
	2	CQDFMB2■	1	¼
	3	CQDFMB3■	1	¼
NGG, HGG, LGG	1	FMPG1	1	¼
	2	FMPG2	1	¼
	3	FMPG3	1	¼

## Back Mounting Plates

ED2, ED4, ED6, HED4, HED6	1	E2BMB	1	¼
---------------------------	---	-------	---	---

## Mounting Screw Kits

CQD, CQD6	CQDSMK <sup>①</sup>	1	1¼
NGG, HGG, LGG	MSKG4 <sup>②</sup>	1	¼
All QR	MSQR3	1	½
All ED (CED6 requires 2 kits)	MSE6 <sup>③</sup>	1	¼
	MSE6100 <sup>④</sup>	100 <sup>④</sup>	1
All FD (CFD6 requires 2 kits)	MSF6 <sup>③</sup>	1	¼
	MSF650 <sup>④</sup>	50 <sup>④</sup>	1
All EG 1-pole	MSKE1	—	—
All EG 2-pole	MSKE2	—	—
All EG 3 or 4-pole	MSKE4	—	—
All JD, LD	MSJ6 <sup>⑤</sup>	1	¼
All LMD	MSLMD	1	¼
All MD, ND,	MSMN	1	¼
All PD, RD	MSPR6	1	2



## "MI" Mechanical Interlocks

For Use With Breaker Type(s)	Panel <sup>⑦</sup> Mounted	Plug-in Mounted	Standard Package	Wt Lb Std Pkg
All EG (Sliding Bar)	HSBE	—	1	—
All QR (Sliding Bar)	SBMIQR	—	1	1½
All FD	MI5444	MI5444	1	—
All JD, LD	MI5413 <sup>④</sup>	—	1	1
All LMD	MI5406 <sup>④</sup> ■	—	1	1
All MD	MI5404 <sup>⑤</sup> ■	—	1	3
All ND	MI5404 <sup>⑤</sup> ■	—	1	3
All PD, RD	MI5405 <sup>⑤</sup> ▲	—	—	—

■ Built to order. Allow 2–3 weeks for delivery.  
▲ Built to order. Allow 6–8 weeks for delivery.  
① Kit consists of 4 screws and washers.  
② Consists of 1 screw and washers (order 100).  
③ Consists of 1 screw and washers (order 50).

④ With mechanical interlock in place, no accessory can be installed into circuit breaker right pole.  
⑤ Addition of the mechanical interlock will prevent accessory installation in the left pole.  
⑥ Sold only in standard package quantities. Multiply List Price Each times package quantity for full price.

⑦ Mechanical interlock is not designed for use within Siemens panelboards.

# Molded Case Circuit Breakers

External Accessories

Selection

## Rotary Door Mounted Operating Handles

Types 1, 3, 3R, 12, 4 4X

For Use With Breaker Frames	Complete Mechanism		Handle Only	Breaker Operator	Shaft Only	
	Catalog Number				Catalog Number	Length (inches)
	Standard Depth	Variable Depth				
EG	RHVE64X	RHVE124X	—	—	—	—
ED <sup>①</sup>	CRHOESD	CRHOEVD	CRHOH <sup>③</sup>	RHOEBO	2	RHOSSD
FD	CRHOFSD	CRHOFVD		RHOFBO	12	RHOSVD
JD, LD	CRHOJSD	CRHOJVD		RHOJBO	16	RHOSXD
LMD	CRHOLMSD	CRHOLMVD		RHOLMBO		
MD, ND PD, RD	RHONSD	RHONVD	RHOH <sup>③</sup>	RHONBO <sup>④</sup>	3 12 24	RHONSSD▲ RHONSVD RHONSXD

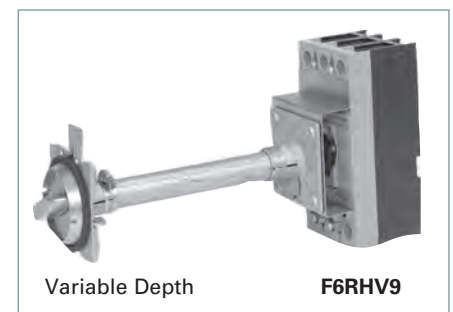
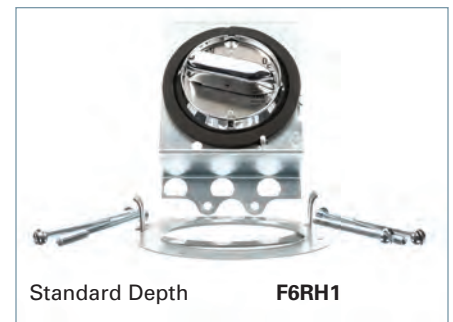

## Rotary Door Mounted Operating Handles

Types 1 & 12

For Use With Breaker Frames	Standard Depth Catalog Number	Variable Depth Catalog Number	Handle and Shaft Catalog Number	Breaker Operator Catalog Number
CQD, NGG, HGG, LGG	—	RHOCQVD	RHOH62 <sup>⑤</sup>	CQDOP
ED	D11CEU1	D11CEU2	—	—
FD	D11CFU1▲	D11CFU2	—	—
JD, LD	—	D11CJU2	—	—

For CQD, NGG, HGG and LGG red emergency handle, order assembly RHOCQVDE (includes handle and operator).▲  
For CQD, NGG, HGG and LGG in a NEMA 3R enclosure, order CQDOP34 operator, RHOH handle and RHOSVD shaft.  
For CQD, NGG, HGG and LGG in a NEMA 4 or 4X enclosure, order CQDOP34 operator, RHOH4 handle and RHOSVD shaft.

## Through Door Mounted Operating Handles<sup>②</sup>

Types 1 & 12

For Use With Breaker Frames	Standard Depth	Variable Depth
	Catalog Number	Catalog Number
CQD, NGG, HGG, LGG	FMHOS	—
EG (3 & 4-Pole only)	RHFESD	—
EG (red handle)	RHFESDEM	—
ED	E2RH1	E2RHV9
FD	F6RH1	F6RHV9

## Door Latch Kits

Type	Catalog Number	
	Right Hand	Left Hand
2 point latch	DKR2	DKL2■
3 point latch	DKR3	DKL3■

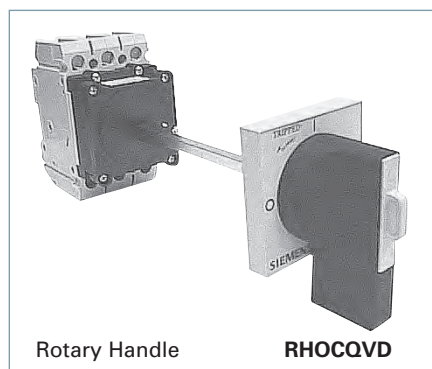

- Built to order. Allow 2-3 weeks for delivery.
- ▲ Built to order. Allow 6-8 weeks for delivery.
- ① For use on 3-pole ED frame only.

- ② Meets the requirements of NFPA 79, section 5.3.3.1 for locking external operator disconnecting devices.
- ③ For 3 or 3R, order shaft and breaker operator as shown, and handle RHOH. For 4 & 4X, order handle RHOH4. Consult sales office for additional EG operator shaft lengths.

- ④ For extended shaft support order catalog number RHONSB2.
- ⑤ Length of shaft is 300mm (11.8 inches).



# Molded Case Circuit Breakers

## External Accessories

## Selection

### Max-Flex™, Flange Mounted Variable Depth Operators<sup>③</sup>

Frames	NEMA Type	Complete Kit Catalog Number	Handle Only Catalog Number	Breaker Operator Catalog Number	36" Cable Catalog Number
GG	1, 3 (R), 12	MFKG3R3	MFHG3R	MFMG	MFCF036
	4 (x)	MFKG4X3	MFHG4X		
EG	1, 3 (R), 12	MFKE3 <sup>④</sup>	—	—	—
	4 (x)	MFKE4X3	—		
ED	1, 3 (R), 12	FHOE036 <sup>①</sup>	FHOH	FHOEBO <sup>①</sup>	FHOEC036
	4 (x)	—	FHOH4		
FD	1, 3 (R), 12	FHOF036	FHOH	FHOFBO	FHOFC036
	4 (x)	—	FHOH4		
JD, LD, SJD, SLD	1, 3 (R), 12	FHOJ036	FHOH	FHOJBO	FHOJC036
	4 (x)	—	FHOH4		
LMD	1, 3 (R), 12	FHOLM036	FHOH	FHOLMBO	FHOJC036
	4 (x)	—	FHOH4		
MD, ND, PD, RD, SMD, SND, SPD	1, 3 (R), 12	FHON048	FHOHN	FHONBO	FHONC048 <sup>②</sup>
	4 (x)	—	FHOHN4		



Max-Flex™ handles are available with solid black handles instead of the customary “red for on” flange handle. These are preferred for use in IEC markets, where red handles have specific meaning. Order components separately, appending the letter “i” to the catalog number (e.g. FHOHi).

### Alternate Length Cable Only

	ED	FD	JD/LD/LMD	MD/ND/PD/RD
Inches	Catalog Number	Catalog Number	Catalog Number	Catalog Number
48	FHOEC048	FHOFC048	FHOJC048	FHONC048
60	FHOEC060	FHOFC060	FHOJC060	FHONC060
72	FHOEC072	FHOFC072	FHOJC072	FHONC072
96	FHOEC096	FHOFC096	FHOJC096	FHONC096
120	FHOEC120▲	FHOFC120	FHOJC120▲	FHONC120▲
144	FHOEC144▲	FHOFC144▲	FHOJC144▲	FHONC144▲

### Handle Auxiliary Switch

For use with Max-Flex and Rotary Door operators (FHOH and RHOH). 1 NO and 1 NC contact (Form C).

For Use With	Catalog Number
ED, FD, JD, LD, LMD, ND, PD, RD, SD, Max Flex	HAS1

### Fixed Depth Flange Mounting

Frames	Minimum Enclosure Depth	NEMA Type	Left Hand Mount	Right Hand Mount
			Catalog Number	Catalog Number
ED <sup>⑤</sup>	6.44	1, 3R, 12	DFBEL▲	DFBER▲
		4, 4X	DFBEL4▲	DFBER4▲
FD	6.44	1, 3R, 12	DFBFL▲	DFBFR▲
		4, 4X	DFBFL4▲	DFBFR4▲

Max-Flex™ handles are available with solid black handles instead of the customary “Red On” flange handle. These are preferred for use in IEC markets, where red handles have specific meaning. Order components separately, appending the letter “i” to the catalog number (e.g. FHOHi).

④Consult sales office for additional cable lengths for EG Flex Shaft Operators. For 3-Pole only.  
⑤3-Pole ED only.

▲ Built to order. Allow 6–8 weeks for delivery.

①For 1- or 2-pole breaker order FHOED036 complete kit or FHOEBO breaker operator only. Use MFHM3R handle.

②48 inch cable is standard length for M through R frame Max-Flex operators.

③Meets requirements of NFPA 79, section 5.3.3.1 for locking external operator disconnecting devices

# Molded Case Circuit Breakers

External Accessories

Selection/Dimensions

## Telemand® Motor Operator

Breaker Frame	AC Voltage	Hinged to Open Down Catalog Number
ED except CED	120	MOE6120
	240	MOE6240▲

ED motor operator opens downward.

Breaker Frame	DC Voltage	Hinged to Open Right Catalog Number	AC Voltage	Hinged to Open Right Catalog Number
FD	24	MOF6024DC▲	120	MOF6120
	48	MOF6048DC▲	240	MOF6240
	125	MOF6125DC▲		
JD, LD	24	MOJ6024DC▲	120	MOJ6120
	48	MOJ6048DC▲	240	MOJ6240
	125	MOJ6125DC▲		
LMD	24	MOLMD6024DC▲	120	MOLMD6120
	48	MOLMD6048DC▲	240	MOLMD6240
	125	MOLMD6125DC▲		
MD, ND, PD, RD	—	—	120	EMOPL120MN
	—	—	240	EMOPL240MN

To order FD through RD motor operators with Left side hinges, add "L" to catalog number (e.g. MOF6120L). List prices are the same.▲



Telemand Motor Operator

FD, JD, LD, LMD, MD, ND, PD, RD Frames

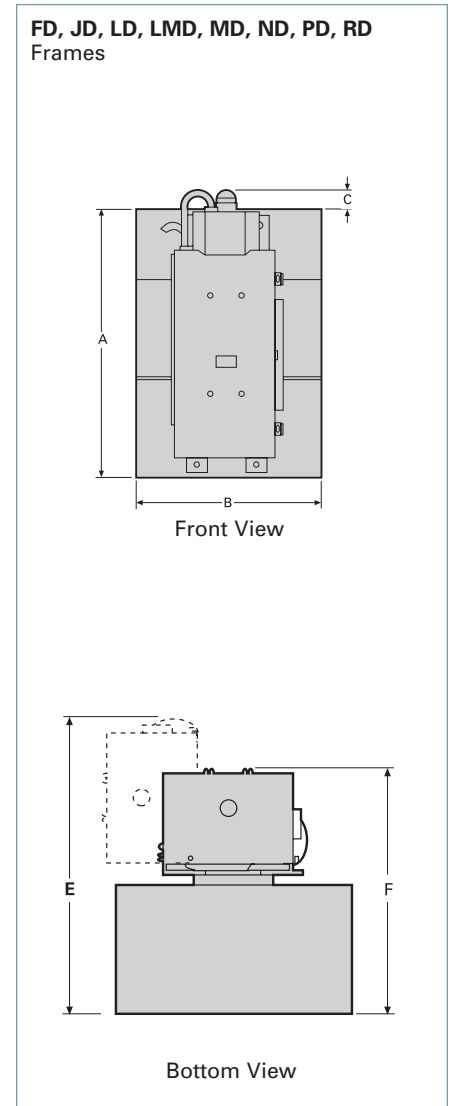

## Dimensions

Frame	A	B	C	D	E	F
ED	7.04	4.31	—	4.31	13.84	8.84
FD	9.50	4.55	1.60	6.84	9.70	7.58
JD, LD, LMD	11.00	7.50	0.79	8.34	9.85	7.74
MD, ND, PD, RD	16.00	9.00	—	9.83	13.13	10.13

## Operating Currents

Catalog Number	On			Off			Reset (Amps)
	In-Rush (Amps)	Running (Amps)	Time (msec)	In-Rush (Amps)	Running (Amps)	Time (msec)	
MOE6120	10.25	2.3	550	10	2.3	400	2.3
MOE6240	5.2	1.1	500	5	1	330	1.1
MOF6120/L	13.6	5.5	200	13.6	5.5	175	5.5
MOF6240/L	7.6	3.5	200	7.6	3.5	185	3.5
MOLMD6120/L	13.6	6	210	13.6	6	185	6
MOJ6120/L	13.6	6	210	13.6	6	185	6
MOJ6240/L	7.6	3.5	217	7.6	3.5	185	3.5
EMOPL120MN	15	5.5	500	15	5.5	500	5.5
EMOPL240MN	7.6	3.25	500	7.6	3.25	500	3.25

For inches / millimeters conversion, see Application Data section.

▲ Built to order. Allow 6-8 weeks for delivery.

# Molded Case Circuit Breakers

## External Accessories

## Selection

### Plug-In Mounting Assemblies, Including Base and Tulip Assemblies

For Use With Breaker Frames	Poles	Line Side	Load Side	Steel Switchboard Mounting Plate <sup>①</sup> Catalog Number
		Catalog Number <sup>②</sup>	Catalog Number <sup>②</sup>	
EG	3	PCBERC3 <sup>③</sup>	—	—
	4	PCBERC4 <sup>③</sup>	—	
All ED except CED	2	PC2637▲	PC2638▲	PL2616
	3	PC2657	PC2658	
CED	2	PC2637▲	PC2638▲	PL2617
	3	PC2657	PC2658	
All FD except CFD	2	PC4753▲	PC4753▲	PL4762
	3	PC4754	PC4754	
CFD	2	PC4753▲	PC4753▲	PL4763
	3	PC4754	PC4754	
All JD except CJD	2	PC5777▲	PC5777▲	PL5796
	3	PC5778	PC5778	
Kit CJD, SCJD	3	PCCJD	PCCJD	PL5797
All LD except CLD	2	PC5660▲	PC5660▲	PL5680
	3	PC5661	PC5661	
Kit CLD, SCLD	3	PCCLD	PCCLD	PL5797
All MD	2	PC5662▲	PC5662▲	PL9698
	3	PC5663	PC5663	
All ND	2	PC5664 <sup>③</sup> ▲	PC5664 <sup>③</sup> ▲	PL9699
	3	PC5666 <sup>③</sup>	PC5666 <sup>③</sup>	

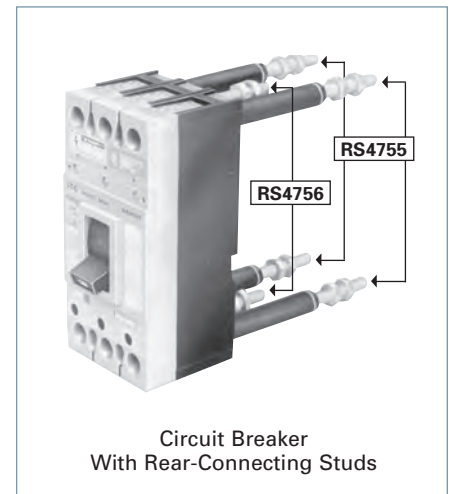
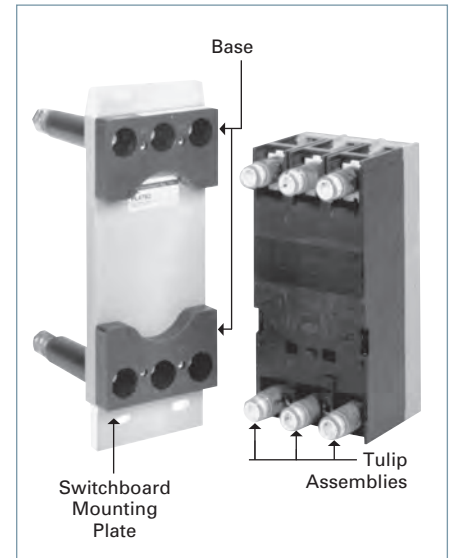

### Tulip Assemblies Separately

For Frame	2-Pole	3-Pole
	Catalog Number	Catalog Number
ED	TCE2▲	TCE3▲
FD	TCF2▲	TCF3▲
JD	TCJ2▲	TCJ3▲
LD	TCL2▲	TCL3▲
MD	TCM2▲	TCM3▲
ND	TCN2▲	TCN3▲

### Rear-Connecting Studs

For Use With Breaker Frames	Ampere Rating	Description	Extension Behind Breaker (inches)	Line Side	Load Side
				Catalog Number <sup>④</sup>	Catalog Number <sup>④</sup>
All ED	100	Line Side (Short)	2.38	RS2643 <sup>⑤</sup> ▲	—
	100	Load Side (Short)	2.38	—	RS2644 <sup>⑤</sup> ▲
	100	Line Side (Long)	4.88	RS2641 <sup>⑤</sup> ▲	—
	100	Load Side (Long)	4.88	—	RS2642 <sup>⑤</sup> ▲
All FD	250	Short	3.12	RS4756 <sup>⑤</sup> ▲	RS4756 <sup>⑤</sup> ▲
	250	Long	7.06	RS4755 <sup>⑤</sup> ▲	RS4755 <sup>⑤</sup> ▲
All JD	400	Short	5.85	RS5774▲	RS5774▲
	400	Long	11.20	RS5773▲	RS5773▲
All LD	600	Short	5.85	RS5784▲	RS5784▲
	600	Long	11.20	RS5783▲	RS5783▲
CJD, SCJD CLD, SCLD	Add required shield kit.				CLRSJL3
LM(X)D6, HLM(X)D6	800	Short	5.85	RS5788▲	RS5788▲
		Long	11.20	RS5787▲	RS5787▲
All MD, ND	1200	Short	5.50	RS5786▲	RS5786▲
		Long	8.00	RS5785▲	RS5785▲

▲ Built to order. Allow 6–8 weeks for delivery.

① Must be ordered separately with other plug-in assemblies.

② Each piece catalog number consists of (1) mounting block assembly and required tulip assemblies (2) for 2-pole, (3) for 3-pole

③ For vertical bus mounting — for horizontal, substitute PC5665 for PC5664 and PC5667 for PC5666.

④ Price includes one current stud, insulating tube, stud nuts and terminal shields, when required.

⑤ For proper electrical clearance, studs must alternate between short and long stud lengths on circuit breaker poles (e.g. SLSLSL or LSLLSL).

⑥ Plug-in assembly for EG breakers include line and load side in one assembly.

# Molded Case Circuit Breakers

## Unusual Operating Conditions

Reference

**Note:** The information provided on this and the next page is intended for reference and recommendation only. Because several variables can act on a circuit breaker's performance at the same time, the data below is based less on controlled testing, than on experience and engineering judgment. Contact Siemens for further information on special conditions and treatment.

### High Ambient Temperatures

Because thermal-magnetic trip breakers are temperature sensitive and calibrated for a specific ambient of 40°C (104°F) (average enclosure temperature), a higher ambient will cause the breaker to trip at lower current than its nameplate rating, in other words, causing the breaker to "derate" (see Table 1). Similarly, the current carrying capacity of a circuit conductor is based upon a certain ambient temperature, a higher ambient will reduce its current carrying capacity, causing it to "derate." Thus, with a fluctuating temperature, a thermal-magnetic breaker will derate nearly parallel with its connected circuit conductors and maintain close circuit protection. If the application temperature exceeds 40°C (104°F) and is known, either a breaker specially calibrated for the higher ambient or one oversized according to Table 1 may be selected. In a case such as this, the circuit conductors should be oversized as well.

Siemens Sensitrip® IV and Type SB Encased Systems Breakers are insensitive to temperature changes. However, they do include circuitry to protect the components from abnormally high temperatures.

### Moisture — Corrosion

For atmospheres having high moisture content and / or where fungus growth is prevalent, a special preventive treatment may be required.

Where the air is heavily laden with corrosive elements, breakers made with special corrosion-resistant finishes may be required.

### Altitude

Reduced air density at altitudes greater than 6600 ft. (2000 meters) affects the ability of a molded case circuit breaker to transfer heat and interrupt faults. Therefore, circuit breakers applied at these altitudes should have interrupting, insulation and continuous currents derated as indicated in Figure 1.

**Table 1 — Temperature Derating Data for Thermal-Magnetic Breakers**

Reference Ampere Rating at 40°C (104°F)	Ampere Rating at:		Siemens Breaker Frames
	50°C (122°F)	60°C (140°F)	
15	13	11	BQ, BL, BQD, CQD, GG, GB, ED
20	18	16	
25	23	21	
30	28	26	
35	30	28	
40	37	34	
50	46	42	
60	56	52	
70	65	60	
90	84	78	
100	94	87	
125	114	100	
150	136	120	
175	159	140	
200	182	160	
225	205	180	
250	235	220	
300	276	252	
350	325	301	
400	372	340	
500	468	435	
600	564	525	
700	658	613	
800	754	704	
900	828	749	
1000	900	825	
1200	1090	1000	
1400	1304	1148	
1600	1500	1320	
1800	1690	1485	
2000	1880	1650	
			QR
			FD
			JD
			LD
			MD
			ND
			PD
			RD

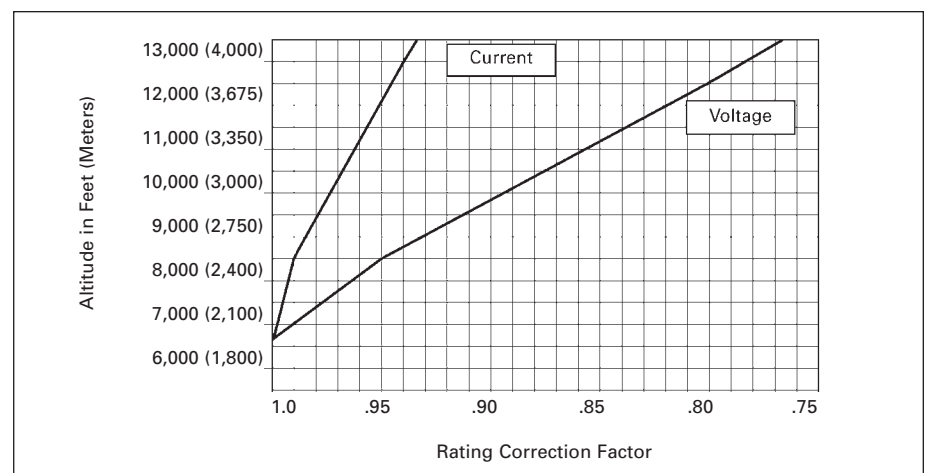

Figure 1 — Altitude Adjustment

# Molded Case Circuit Breakers

## 400 Hz Systems<sup>①</sup>

Siemens molded case circuit breakers can be applied for overcurrent protection on 400Hz systems, commonly used to power computer installations, aircraft, military and other specialty equipment. Below are basic guidelines.

### Circuit Breaker Derating Required

This table lists the maximum continuous current carrying capacity for Siemens breakers at 400Hz. Due to the increased resistance of the copper sections resulting from the skin effect produced by eddy currents at these frequencies, circuit breakers in many cases require derating. The thermal derating on these devices is based upon 100%, three phase application in open air in a maximum of 40°C (104°F) with 48 in. (1219 mm) of the specified cable or bus at the line and load side. Additional derating of not less than 20% will be required if the circuit breaker is to be utilized in an enclosure. Further derating may be required if the enclosure

ambient temperature exceeds 40°C (104°F).

### Cable and Bus Sizing

The cable and bus sizes to be utilized at 400Hz are not based on standard National Electric Codes tables for 60Hz application. Larger cross sections are necessary at 400Hz. All bus bars specified are based upon mounting the bars in the vertical plane to allow maximum air flow. All bus bars are spaced at a minimum of 0.25 in. (6 mm) apart. Mounting of bus bars in the horizontal plane will necessitate additional drafting. Edgewise orientation of the bus may change the maximum ratings indicated. If additional information is required for other connections of cable or bus, contact Siemens for information.

### Application Recommendations

It is recommended that temperatures be measured on the line and load terminals or T-connectors of the center pole. These

are usually the hottest terminals with a balanced load. A maximum temperature of 75°C (35°C over a maximum ambient of 40°C) would verify the particular application. Temperature profiles taken on these breakers can be correlated to ensure that the hottest points within the breaker are within the required temperature limits.

### Factory Configuration

When required, molded case circuit breakers may be factory calibrated for 400Hz application. These breakers are specially labeled for 400Hz usage and their nameplate current rating will include the necessary derating factory. The highest "Maximum Continuous Amperes" rating at 400Hz, found in the table below approximates the highest specially calibrated 400Hz nameplate ampere rating available for a given frame size. Contact Siemens for ordering information on other breakers applied in 400Hz systems.

## 400Hz Breakers

Siemens Breaker Type	Maximum Continuous Ampere Rating At 40°C (104°F) <sup>②</sup>			75°C (167°F) Copper Cable per Pole	
	60HZ		Enclosed After Derating	No of Pieces	Wire Size
	Open Air	Open Air <sup>③</sup>			
ED2, ED4, ED6, BOD, HED4, HED6, CED6, GG, GB	15	15	12	1	#14
	20	20	16	1	#12
	25	25	20	1	#10
	30	30	24	1	#10
	35	35	28	1	#10
	40	40	32	1	#8
	45	43	34	1	#8
	50	48	38	1	#8
	60	57	46	1	#6
	70	67	54	1	#4
	80	76	61	1	#4
	90	86	69	1	#3
	100	95	76	1	#3
110	105	84	1	#2	
125	119	95	1	#1	
QR2, QR2H, HQR2, HQR2H, FD6, FXF6, HFD6, HFXD6, CFD6	70	63	50	1	#4
	80	72	58	1	#4
	90	80	64	1	#3
	100	90	72	1	#3
	110	95	75	1	#2
	125	105	84	1	#1
	150	125	100	1	#1/0
	175	140	112	1	#2/0
	200	160	128	1	#3/0
	225	180	144	1	#4/0
	250	200	160	1	250 kcmil
JXD2, JD6, JXD6, HJD6, HJXD6, HHJD6, HHJXD6, CJD6	200	170	136	1	#3/0
	225	190	152	1	#4/0
	250	210	168	1	250 kcmil
	300	240	192	1	350 kcmil
	350	260	208	1	500 kcmil
	400	300	240	2	#3/0
JD6, JXD6, HJD6, HJXD6 100% Rated	200	170	170	2	#3/0
	225	190	190	2	#4/0
	250	210	210	1	250 kcmil
	300	240	240	1	350 kcmil
	350	260	260	1	500 kcmil
400	300	300	2	#3/0	

Siemens Breaker Type	Maximum Continuous Ampere Rating At 40°C (104°F) <sup>②</sup>			75°C (167°F) Copper Cable per Pole	
	60HZ		Enclosed After Derating	No of Pieces	Wire Size
	Open Air	Open Air <sup>③</sup>			
LD6, LXD6, HLD6, HLXD6, HHL6, HHLXD6, CLD6	250	210	168	1	250 kcmil
	300	240	192	1	350 kcmil
	350	260	208	1	500 kcmil
	400	300	240	2	#3/0
	450	340	272	2	#4/0
	500	375	300	2	250 kcmil
	600	420	336	2	350 kcmil
	250	210	210	1	250 kcmil
LD6, LXD6, HLD6, HLXD6, 100% Rated	300	240	240	1	350 kcmil
	350	260	260	1	500 kcmil
	400	300	300	2	#3/0
	450	340	340	2	#4/0
	500	375	375	2	250 kcmil
	600	420	420	2	350 kcmil
	500	400	320	2	250 kcmil
	600	430	360	2	350 kcmil
MD6, MXD6, HMD6, HMXD6, CMD6	700	500	400	3	250 kcmil
	800	560	448	3	300 kcmil
	500	400	400	2	250 kcmil
	600	430	430	2	350 kcmil
MD6, MXD6, HMD6, HMXD6, CMD6 100% Rated	700	500	500	3	250 kcmil
	800	560	560	3	300 kcmil
	800	560	448	3	300 kcmil
	900	600	480	3	350 kcmil
ND6, NXD6, HND6, HNXD6, CND6	1000	650	520	3	400 kcmil
	1200	780	624	4	350 kcmil
	900	600	600	3	350 kcmil
	1000	650	650	3	400 kcmil
ND6, NXD6, HND6, HNXD6, CND6 100% Rated	1200	780	780	4	350 kcmil
	1200	780	624	4	400 kcmil
	1400	850	680	4	500 kcmil
	1600	960	768	5	500 kcmil
PD6, PXD6, HPD6, HFXD6, CPD6	1200	780	780	4	400 kcmil
	1400	850	850	4	500 kcmil
	1600	960	960	5	500 kcmil
	1600	960	768	5	500 kcmil
PD6, PXD6, HPD6, HFXD6, CPD6 100% Rated	1600	960	960	5	500 kcmil
	1600	960	768	5	500 kcmil
	1800	1080	864	5	500 kcmil
	2000	1200	960	6	500 kcmil

①The information provided on this page is intended for reference and recommendation only. Because several variables can act on a circuit breaker's performance at the same time, the data above is based less on

controlled testing, than on experience and engineering judgment. Contact Siemens for further information on special conditions and treatment.

②Additional derating may be required if the ambient

temperature is greater than 40°C (104°F).

③Calculated after derating to compensate for the heating of the copper conductor, caused by the skin effect generated by eddy currents produced at 400/415Hz.

# Molded Case Circuit Breakers

Notes

7

MOLDED CASE  
CIRCUIT BREAKERS

# VL Circuit Breakers

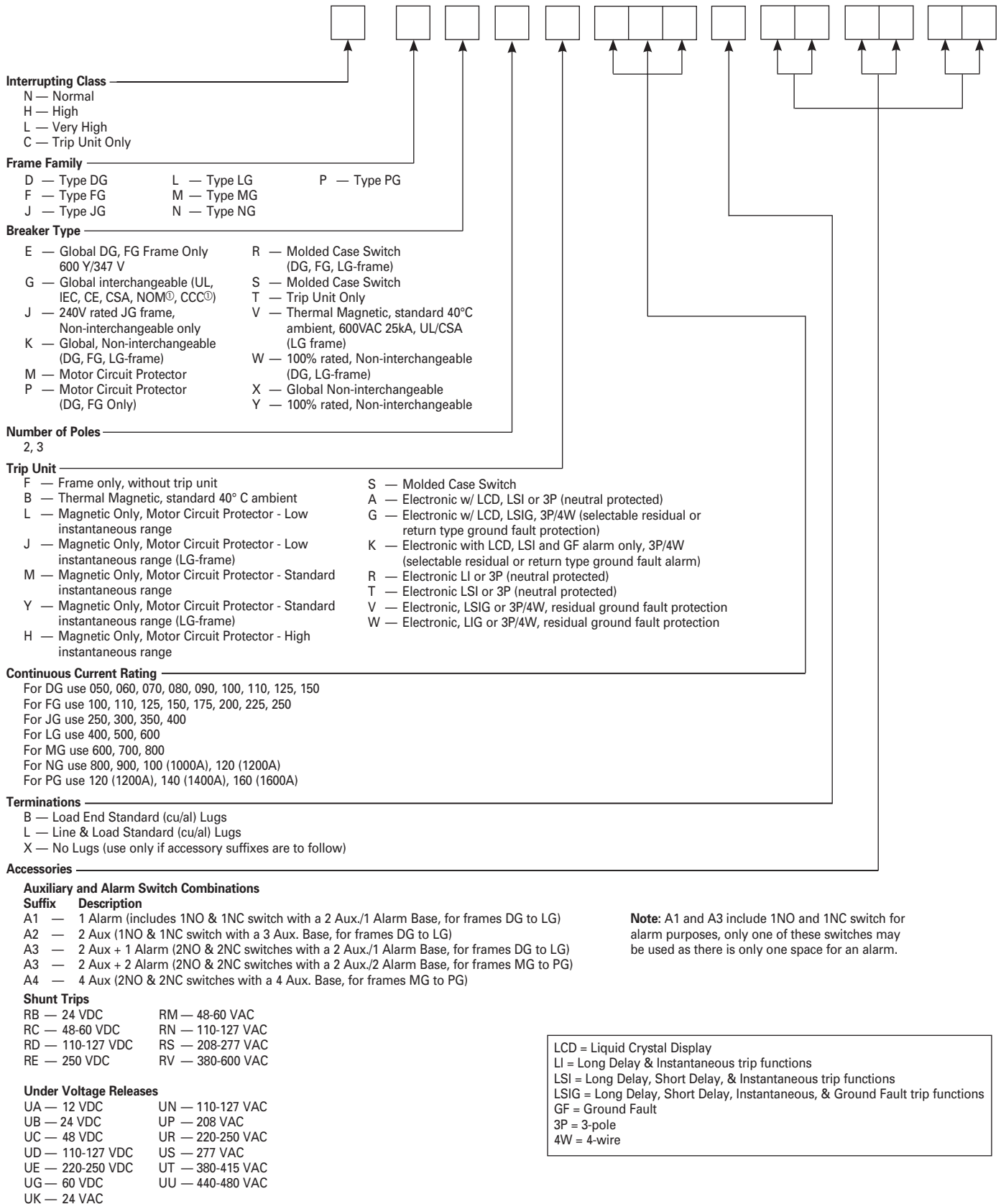

© Select Frames

# VL Circuit Breakers

## Catalog Numbering System

Selection

If ordering factory-installed accessories or special modifications, you must order a 15-digit catalog number. See the examples below for a detailed explanation. The 15 digit number is achieved by placing X's in positions not being occupied by an accessory/modification. Contact Siemens for circuit breakers configured with accessories.

### Auxiliary Switch Example:

**HFG3B200L A2 XXXX**

Standard 9-digit      Aux. Switch      Completes Cat #

### Shunt Trip / UVR Example:

**HFG3B200L XX UN XX**

Standard 9-digit      UVR      Completes Cat #

### Shunt Trip / Auxiliary Switch Example:

**HFG3B200L A2 RN XX**

Standard 9-digit      Aux. Switch      Shunt Trip      Completes Cat #

### Non-Interchangeable Trip Breakers Example:





**HFX3B200L**

Standard 9-digit



# VL Circuit Breakers

## Frame Summary and Ratings Table

Frame Family	DG	FG	JG	
				
<b>Continuous Ampere Range</b>	30 to 150A	40 to 250A	70 to 400A	
<b>Number of Poles</b>	2, 3	2, 3	2, 3	
<b>Maximum Voltage Rating</b>	600Y/347	600Y/347	600V	
<b>Type of Protection</b>				
Thermal-Magnetic	◆	◆	◆	
Electronic	◆	◆	◆	
Electronic with LCD	◆	◆	◆	
Motor Circuit Protector	◆	◆	◆	
Molded Case Switch	◆	◆	◆	
100% Rated Breaker	◆	◆	◆	
Interchangeable Trip Unit	—	—	◆	
 W In.(mm)	4.1 (105)	5.5 (139)		
H	7.3 (175)	11 (279)		
D	3.4 (81)	4.2 (102)		
D1	4.2 (107)	5.4 (138)		
<b>Type N – Normal</b> Interrupting Rating <sup>①</sup> , RMS Symmetrical Amperes (kA)				
UL	240Vac	65	65	65
	480Vac	35	35	35
	600Vac <sup>②</sup>	18	18	25
IEC (I <sub>cu</sub> /I <sub>cs</sub> )	240Vac	65/65	65/65	65/65
	415Vac	40/40	40/40	45/45
	690Vac	12/6	12/6	12/6
<b>DC Voltages – Interrupting Rating (kA)<sup>④</sup></b>				
	250Vdc - 2p	30	30	30
	500Vdc - 3p <sup>③</sup>	18	18	25
<b>Type H – High</b> Interrupting Rating <sup>①</sup> , RMS Symmetrical Amperes (kA)				
UL	240Vac	100	100	100
	480Vac	65	65	65
	600Vac <sup>②</sup>	18	18	25
IEC (I <sub>cu</sub> /I <sub>cs</sub> )	240Vac	100/75	100/75	100/75
	415Vac	70/70	70/70	70/70
	690Vac	12/6	12/6	15/8
<b>DC Voltages – Interrupting Rating (kA)<sup>④</sup></b>				
	250Vdc - 2p	30	30	30
	500Vdc - 3p <sup>③</sup>	18	25	35
	600Vdc - 3p <sup>②</sup>	42	42	65
<b>Type L – Very High</b> Interrupting Rating <sup>①</sup> , RMS Symmetrical Amperes (kA)				
UL	240Vac	200	200	200
	480Vac	100	100	100
	600Vac <sup>②</sup>	18	18	25
IEC (I <sub>cu</sub> /I <sub>cs</sub> )	240Vac	200/150	200/150	200/150
	415Vac	100/75	100/75	100/75
	690Vac	12/6	12/6	15/8
<b>DC Voltages – Interrupting Rating (kA)<sup>④</sup></b>				
	250Vdc - 2p	30	30	30
	500Vdc - 3p <sup>③</sup>	18	30	35





① UL does not recognize AIC ratings for Molded Case Switches or Motor Circuit Protectors.  
 ② For 600 VDC breakers see page 7-186.

③ 500Vdc nominal, 600Vdc max. for ungrounded DC UPS systems.  
 ④ DC Interruption Ratings do not apply to electronic trip circuit breakers.

⑤ DG & FG breakers are 600Y/347V.

# VL Circuit Breakers

## Frame Summary and Ratings Table — Continued

Frame Family	LG	MG	NG	PG	
					
<b>Continuous Ampere Range</b>	150 to 600A	200 to 800A	300 to 1200A	400 to 1600A	
<b>Number of Poles</b>	2, 3	2, 3	2, 3	3	
<b>Maximum Voltage Rating</b>	600V	600V	600V	600V	
<b>Type of Protection</b>					
Thermal-Magnetic	◆	◆	◆	◆	
Electronic	◆	◆	◆	◆	
Electronic with LCD	◆	◆	◆	◆	
Motor Circuit Protector	◆	◆	◆	—	
Molded Case Switch	◆	◆	◆	◆	
100% Rated	400/500 Amp	◆	◆	◆	
Interchangeable Trip Unit	—	◆	◆	◆ <sup>Ⓞ</sup>	
 W In.(mm)	5.5 (139)	7.5 (190)	9 (229)		
H	11 (279) <sup>Ⓞ</sup>	16 (406)	16 (406)		
D	4.2 (102)	4.7 (114)	6.2 (157)		
D1	5.4 (138)	5.9 (151)	8.1 (207)		
<b>Type N – Normal</b> Interrupting Rating <sup>①</sup> , RMS Symmetrical Amperes (kA)					
UL	240Vac	65	65	65	65
	480Vac	35	35	35	35
	600Vac	18	25	25	25
IEC (I <sub>cu</sub> /I <sub>cs</sub> )	240Vac	65/65	65/65	65/65	65/65
	415Vac	45/45	50/50	50/25	50/25
	690Vac	12/6	20/10	20/10	20/10
<b>DC Voltages – Interrupting Rating (kA)<sup>④</sup></b>					
	250Vdc - 2p	30	22	22	22
	500Vdc - 3p <sup>③</sup>	25	35	35	35
<b>Type H – High</b> Interrupting Rating <sup>①</sup> , RMS Symmetrical Amperes (kA)					
UL	240Vac	100	100	100	100
	480Vac	65	65	65	65
	600Vac	18 <sup>Ⓞ</sup>	35	35	35
IEC (I <sub>cu</sub> /I <sub>cs</sub> )	240Vac	100/75	100/75	100/75	100/50
	415Vac	70/70	70/70	70/35	70/35
	690Vac	15/8	30/15	30/15	30/15
<b>DC Voltages – Interrupting Rating (kA)<sup>④</sup></b>					
	250Vdc - 2p	30	25	25	25
	500Vdc - 3p <sup>③</sup>	35	50	50	50
	600Vdc - 3p <sup>⑤</sup>	65	65	65	65
<b>Type L – Very High</b> Interrupting Rating <sup>①</sup> , RMS Symmetrical Amperes (kA)					
UL	240Vac	200	200	200	200
	480Vac	100	100	100	100
	600Vac	18	50	65	65
IEC (I <sub>cu</sub> /I <sub>cs</sub> )	240Vac	200/150	200/150	200/150	200/150
	415Vac	100/75	100/75	100/75	100/75
	690Vac	15/8	35/17	35/17	35/17
<b>DC Voltages – Interrupting Rating (kA)<sup>④</sup></b>					
	250Vdc - 2p	30	42	42	42
	500Vdc - 3p <sup>③</sup>	35	65	65	65

① UL does not recognize AIC ratings for Molded Case Switches or Motor Circuit Protectors.  
 ② 25kA available in a special version. Standard breakers rated 18kA. See page 7-170.

③ 500Vdc nominal, 600Vdc max. for ungrounded DC UPS systems.  
 ④ DC Interruption Ratings do not apply to electronic trip circuit breakers.

⑤ For 600 VDC breakers see page 7-186.  
 ⑥ Thermal-magnetic available non-interchangeable only.  
 ⑦ 13.6" with extended shields.

# VL Circuit Breakers

## Trip Unit Overview

Selection

The interchangeability of the VL circuit breaker trip units allow for easy conversion from any of 3 types of protection. They are thermal-magnetic, electronic, or electronic with a built-in LCD. The thermal-magnetic trip unit features an adjustable magnetic trip setting. The electronic trip units are microprocessor based true RMS sensing devices and are available with a variety of adjustable trip settings, configurations, and infor-

mation menus. With precise control over the circuit breaker functions and access to system status, diagnostics, and information, these trip units allow for unsurpassed flexibility in circuit coordination.

An example of coordination is the out of the box Ground Fault function on the Model 555 trip units. The pick-up and time delay settings are set at the

factory for each frame and do not overlap with the settings on the other frames. Therefore, when VL breakers are used together in a system the GF protection is automatically coordinated. The user also has the ability to program a custom coordination scheme with adjustable settings on both the 555 and 586 trip units.

Trip Unit Functions	VL Trip Units							
	Model 525	Model 555				Model 586		
	Thermal-magnetic	Electronic LI	Electronic LIG	Electronic LSI	Electronic LSIG	Electronic with LCD LSI	Electronic with LCD LSIG	Electronic with LCD LSI + G alarm only
Continuous Current Setting ( $I_r$ )	Fixed	◆	◆	◆	◆	◆	◆	◆
Long Time Delay ( $t_r$ )	□	◆	◆	◆	◆	◆	◆	◆
Instantaneous Function	●	●	●	●	●	(ON/OFF)	(ON/OFF)	(ON/OFF)
Instantaneous Pickup ( $I_i$ )	◆	◆	◆	◆	◆	◆	◆	◆
Short Time Function	□	□	□	●	●	(ON/OFF)	(ON/OFF)	(ON/OFF)
Short Time Pick-up ( $I_{sd}$ )	□	□	□	◆	◆	◆	◆	◆
Short Time Delay ( $t_{sd}$ )	□	□	□	◆	◆	◆	◆	◆
Ground Fault Pick-up ( $I_g$ )	□	□	◆	□	◆	□	◆	□
Ground Fault Delay ( $t_g$ )	□	□	◆	□	◆	□	◆	□
Ground Fault Alarm Pick-up	□	□	□	□	□	□	◆	◆
Ground Fault Alarm Delay	□	□	□	□	□	□	◆	◆
Alarm & Status Indicator	□	●	●	●	●	●	●	●
Built-in Display (LCD)	□	□	□	□	□	●	●	●
Pre-Trip Alarm <sup>①</sup>	□	●	●	●	●	●	●	●
Last Trip Information	□	● <sup>①</sup>	● <sup>①</sup>	● <sup>①</sup>	● <sup>①</sup>	●	●	●
Zone Selective <sup>①</sup>	□	●	●	●	●	●	●	●
Communications <sup>①</sup>	□	●	●	●	●	●	●	●

◆ Adjustable setting  
 ● This feature is included  
 □ Feature is not included.  
 ① Requires a COMPRO20 or COMMOD21 module in a communication system.

### Continuous Amps Rating ( $I_r$ )

This setting is the continuous current that the breaker will carry without tripping. It can be set up to 100% of the trip unit's nominal rating ( $I_n$ ).

### Long Time Delay ( $t_r$ )

Sometimes referred to as the "overload" position, this function controls the breaker's "pause-in-tripping" time. It allows low level, temporary inrush currents such as those encountered when starting a motor to pass without tripping. The time delay begins when the current reaches  $6 \times I_r$ .

### Instantaneous Pick-up ( $I_i$ )

This function sets the breaker to trip instantaneously during high fault conditions. This function may be turned off on Model 586 trip units. Turning this function off will enable an instantaneous trip

override function to ensure self protection of circuit breaker.

### Short Time Pick-Up ( $I_{sd}$ )

This function controls the level of fault current the breaker will carry for a short time without tripping, thus allowing downstream devices to clear short circuits ahead of up-stream protection. It may be defeated (turned-off) on Model 586 trip units.

### Short Time Delay ( $t_{sd}$ )

This controls the interval of time the breaker will remain closed against a fault (at the Short Time Pick-up current level) without tripping. The time delay may be set at fixed points or at short time intervals based on  $I^2t$  curves. This function is used with the Short Time Pick-up to achieve selectivity and better system coordination.

### Ground Fault Pick-Up ( $I_g$ )

This setting controls the level of ground fault current that will cause the breaker to trip. Model 555 Electronic Trip Units act on the residual current to sense ground current. The Model 586 Electronic Trip Unit is programmable and allows the user to select either the residual current method or direct detection (via a separate current transformer) to detect ground current.

### Ground Fault Time Delay ( $t_g$ )

This controls the interval of time the breaker will remain closed after a ground fault is detected (at the Ground Fault Pick-up current level) without tripping.

# VL Circuit Breakers

**Thermal-Magnetic** trip units, Model 525, combine the inverse time element design for low level overloads, and instantaneous magnetic action for short circuit protection. The standard unit has preset overload protection and an adjustable instantaneous trip setting, with 6 set points. Thermal-Magnetic trip units are available throughout the VL family, from 50 to 1600A.

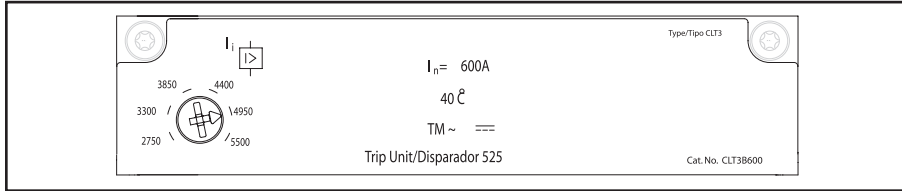

## Electronic Trip Units

Electronic trip units are available through the VL family, from 60A (which can be set as low as 30A) up through 1600A. They are also available in four trip configurations (LI, LIG, LSI, LSIG) and features can include a built-in LCD display.

microprocessor is in operating and another indicates an overload condition. For ease-of-use and to insure proper coordination, the set points for the continuous current are shown on the face of these trip units in amps.

On the Model 555 Electronic Trip Unit a flashing LED confirms that the

On the Model 586, the LCD version, the current in each phase is continuously shown on the display. Unlike many

displays, no secondary or auxiliary voltage is required as long as the breaker is energized and a minimal load current is present. These trip units can also indicate the "last trip" status (date, time, amps) when they're connected to a PC via one of our communications modules. Without being connected via a communication module, the last trip status can be viewed on Model 586 trip units (no time stamp).

## Typical Trip Unit Labeling and Adjustment Positions

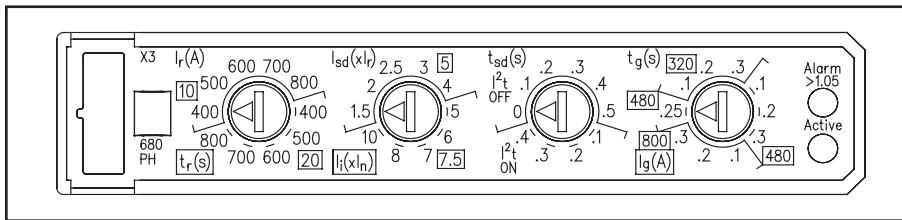

Model 555 Electronic Trip Unit with LSIG trip functions

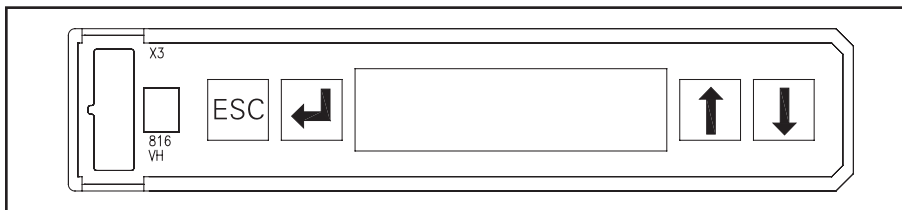

Model 586 Electronic Trip Unit has an LCD display

# VL Circuit Breakers

DG 150A Frame, VL Series

Selection

## Ordering Information

### Complete Assembled Breaker

A complete factory assembled DG breaker includes the frame, trip unit, and standard line and load connectors, all factory installed and shipped as a complete breaker. Assembled breakers are only available with standard connectors.

For DC applications, use thermal magnetic trip unit only.

Breakers are suitable for reverse feed applications.

For special applications, refer to page 7-206.

Mounting hardware is included with each frame or complete breaker.

For 100% rated breakers with a non-interchangeable trip unit, change the 3rd character of the catalog number to "W". Available in electronic and electronic with LCD only.

HACR rated.



## Interrupting Ratings

Interrupting Class	Breaker Type	RMS Symmetrical Amperes (KA)										
		UL 489					IEC 60947-2					
		Volts AC (50/60 Hz)			Volts DC		Volts AC (50/60 Hz)					
		240	480	600Y/347	250	500	220/240		380/415		690	
N	NDGB	65	35	18	30	18	65	65	40	40	12	6
H	HDGB	100	65	18	30	18	100	75	70	70	12	6
L	LDGB	200	100	18	30	18	200	150	100	75	12	6

## Dimensions, inches (mm)

Number of Poles	Width	Length	Depth	To Handle D1
2, 3	4.1 (105)	6.9 (175)	3.4 (81)	4.2(107)

## Connectors for 75°C Wire

Construction	Ampere Rating	Wire Range	No. of cables per connector	Catalog Number
Steel	30-150	#8-1/0 Cu	1	3TW1DG20 <sup>②</sup>
Aluminum	30-150	#6-3/0 Al/Cu	1	3TA1DG30 <sup>①②</sup>
Copper	30-150	#6-3/0 Cu	1	3TC1DG30 <sup>②④</sup>
<b>Distribution Lugs</b>				
	30-150	#14-#2 Al/Cu (3pcs. Max)	3	3TA3DG02 <sup>②</sup>
	30-150	#14-#4 Cu, #14-#6 Al	6	3TA6DG04 <sup>②</sup>
<b>Compression Lugs</b>				
	30-150	#14-2/0 kcmil Al/Cu	-	2CLD20 <sup>③</sup>
	30-150	#14-2/0 kcmil Al/Cu	-	3CLD20 <sup>②</sup>

① Standard connector supplied with complete breakers.

② Kit consists of 3 terminal connectors.

③ 2 Lugs for 2-pole breakers.

④ Required for 100% rated DG breakers. Requires 90°C Cu cable sized at 75°C ampacity

## Approx. Shipping Weight, lbs. (kg)

Poles	Frame	Trip Unit		Complete Breaker
		Thermal-Mag.	Electronic	
2, 3	3.7 (1.7)	2.2 (1.0)	2.6 (1.2)	5.9 (2.7)

## DG Thermal-Magnetic, Instantaneous Trip Adjustment Range

Trip Unit Continuous Amp Rating (I <sub>n</sub> )	Instantaneous Overcurrent Setting (I <sub>t</sub> )	
	Min.	Max.
50	450	600
60	450	600
70	450	700
80	450	800
90	500	1000
100	500	1000
110	550	1100
125	625	1250
150	800	1600

Note: Each breaker has 6 trip settings in this range.

External Accessories pages 7-187 through 7-201

# VL Circuit Breakers

DG 150A Thermal-Magnetic Trip Unit

Selection

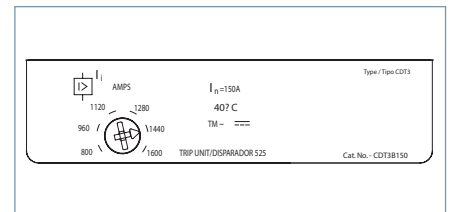

Model 525 Trip Unit

## DG 150A Frame 2-Pole with Thermal-Magnetic Trip Unit

Continuous Ampere Rating	COMPLETE FACTORY ASSEMBLED CIRCUIT BREAKER		
	N-Interrupting Class	H-Interrupting Class	L-Interrupting Class
	Catalog Number	Catalog Number	Catalog Number
50	NDK2B050L	HDK2B050L	LDK2B050L
60	NDK2B060L	HDK2B060L	LDK2B060L
70	NDK2B070L	HDK2B070L	LDK2B070L
80	NDK2B080L	HDK2B080L	LDK2B080L
90	NDK2B090L	HDK2B090L	LDK2B090L
100	NDK2B100L	HDK2B100L	LDK2B100L
110	NDK2B110L	HDK2B110L	LDK2B110L
125	NDK2B125L	HDK2B125L	LDK2B125L
150	NDK2B150L	HDK2B150L	LDK2B150L

## DG 150A Frame 3-Pole with Thermal-Magnetic Trip Unit

Continuous Ampere Rating	COMPLETE FACTORY ASSEMBLED CIRCUIT BREAKER		
	N-Interrupting Class	H-Interrupting Class	L-Interrupting Class
	Catalog Number	Catalog Number	Catalog Number
50	NDK3B050L	HDK3B050L	LDK3B050L
60	NDK3B060L	HDK3B060L	LDK3B060L
70	NDK3B070L	HDK3B070L	LDK3B070L
80	NDK3B080L	HDK3B080L	LDK3B080L
90	NDK3B090L	HDK3B090L	LDK3B090L
100	NDK3B100L	HDK3B100L	LDK3B100L
110	NDK3B110L	HDK3B110L	LDK3B110L
125	NDK3B125L	HDK3B125L	LDK3B125L
150	NDK3B150L	HDK3B150L	LDK3B150L

# VL Circuit Breakers

## DG 150A Electronic Trip Units

Selection

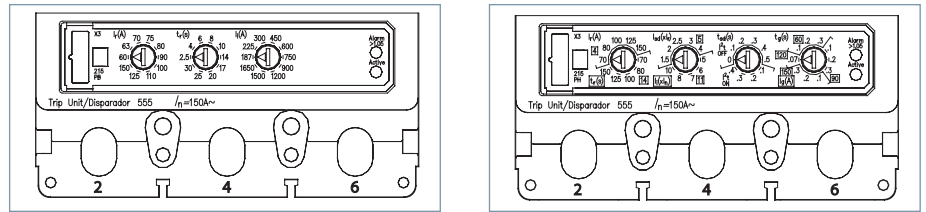

Model 555 Trip Units

## DG 150A Frame 3-Pole Electronic Trip Unit<sup>①</sup>

Continuous Ampere Rating	COMPLETE FACTORY ASSEMBLED CIRCUIT BREAKER		
	N-Interrupting Class	H-Interrupting Class	L-Interrupting Class
	Catalog Number	Catalog Number	Catalog Number
ELECTRONIC LI TRIP			
60	NDK3R060L	HDK3R060L	LDK3R060L
100	NDK3R100L	HDK3R100L	LDK3R100L
150	NDK3R150L	HDK3R150L	LDK3R150L
ELECTRONIC LSI TRIP			
60	NDK3T060L	HDK3T060L	LDK3T060L
100	NDK3T100L	HDK3T100L	LDK3T100L
150	NDK3T150L	HDK3T150L	LDK3T150L
ELECTRONIC LSIG TRIP			
60	NDK3V060L	HDK3V060L	LDK3V060L
100	NDK3V100L	HDK3V100L	LDK3V100L
150	NDK3V150L	HDK3V150L	LDK3V150L
ELECTRONIC LIG TRIP			
60	NDK3W060L	HDK3W060L	LDK3W060L
100	NDK3W100L	HDK3W100L	LDK3W100L
150	NDK3W150L	HDK3W150L	LDK3W150L

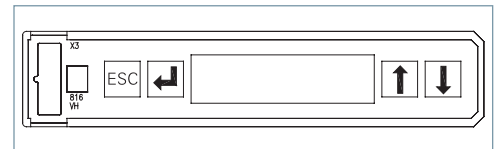

Model 586 Trip Unit

## DG 150A Frame 3-Pole Electronic LCD Trip Unit<sup>①</sup>

Continuous Ampere Rating	COMPLETE FACTORY ASSEMBLED CIRCUIT BREAKER		
	N-Interrupting Class	H-Interrupting Class	L-Interrupting Class
	Catalog Number	Catalog Number	Catalog Number
LCD ELECTRONIC LSI TRIP			
60	NDK3A060L	HDK3A060L	LDK3A060L
100	NDK3A100L	HDK3A100L	LDK3A100L
150	NDK3A150L	HDK3A150L	LDK3A150L
LCD ELECTRONIC LSIG TRIP			
60	NDK3G060L	HDK3G060L	LDK3G060L
100	NDK3G100L	HDK3G100L	LDK3G100L
150	NDK3G150L	HDK3G150L	LDK3G150L
LCD ELECTRONIC LSI TRIP + GF ALARM ONLY			
60	NDK3K060L	HDK3K060L	LDK3K060L
100	NDK3K100L	HDK3K100L	LDK3K100L
150	NDK3K150L	HDK3K150L	LDK3K150L

<sup>①</sup> Due to the location of the magnetic tripping solenoid, the left accessory pocket is not available for accessories.

7 MOLDED CASE CIRCUIT BREAKERS

# VL Circuit Breakers

Internal Accessories for DG 150A and FG 250A Frames

Selection

## Auxiliary Switch and Alarm Switch Combination Kits

Description	Mounting Pocket <sup>①</sup>	Catalog Number
1 Alarm Switch 1A/B <sup>③</sup> Bases AMBL2 & AMBL3	Left, Right <sup>②</sup>	ASKL1
2 Aux. Switches 1A + 1B Bases AMBL1	Left, Right	ASKL2
2 Aux. + 1 Alarm Switch 1A + 1B, 1A/B <sup>③</sup> Bases AMBL2 & AMBL3	Left, Right <sup>②</sup>	ASKL3

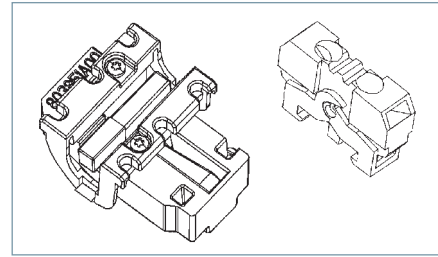

## Auxiliary/Alarm Switch Mounting Base Only

Description	Mounting Pocket	Catalog Number
Up to 3 Auxiliary Switches	Left, Right	AMBL1
2 Aux. + 1 Alarm Switch	Left Pocket Only	AMBL2
2 Aux. + 1 Alarm Switch	Right Pocket Only	AMBL3

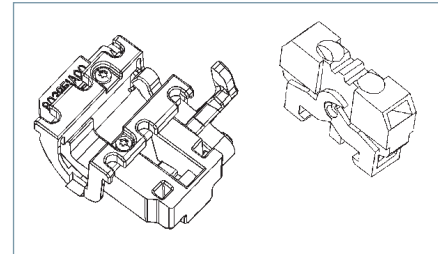

## Auxiliary/Alarm Switch Only Common to DG - PG Frames

Description	Catalog Number
1 Normally Open Contact (1A)	ASWPA
1 Normally Closed Contact (1B)	ASWPB

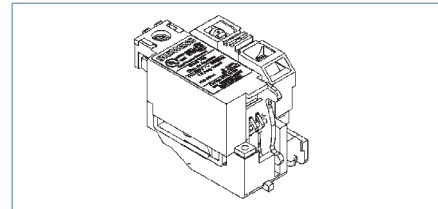

## Shunt Trips

Description	Mounting Pocket	Catalog Number
24 VDC	Right Pocket Only	STRLB24DC
48-60 VDC		STRLC60DC
110-127 VDC		STRLD125DC
220-250 VDC		STRLE250DC
48-60 VAC		STRLM60
110-127 VAC		STRLN120
208-277 VAC		STRLS277
380-600 VAC		STRLV600



## Undervoltage Release

Description	Mounting Pocket	Catalog Number
12 VDC	Right Pocket Only	UVRLA12DC
24 VDC		UVRLB24DC
48 VDC		UVRLC48DC
60 VDC		UVRLG60DC
110-127 VDC		UVRLD125DC
220-250 VDC		UVRLE250DC
24 VAC		UVRLI24
110-127 VAC		UVRLN120
220-240 VAC		UVRLR240
208 VAC		UVRLP208
277 VAC		UVRLS277
380-415 VAC		UVRLT415
440-480 VAC		UVRLU480

① Refer to the "Accessory Locations" chart on page 7-202 for guidelines and limitations about which pockets may be used for accessory combinations.

② These kits include two bases, one for mounting switches in the left pocket and another for mounting in the right.

③ Includes 1A and 1B contact for alarm purposes, only one of which may be installed at any time.

'A' refers to a normally open contact (open when the breaker contacts are open).

'B' refers to a normally closed contact (closed when the breaker contacts are open).

External Accessories pages 7-187 through 7-201



# VL Circuit Breakers

FG 250A Frame, VL Series

Selection/Dimensions

## Ordering Information

### Complete Assembled Breaker

A complete factory assembled FG breaker includes the frame, trip unit, and standard line and load connectors, all factory installed and shipped as a complete breaker. Assembled breakers are available only with standard connectors.

For DC applications, use thermal magnetic trip unit only.

Breakers are suitable for reverse feed applications.

For special applications, refer to page 7-206.

Mounting hardware is included with each frame or complete breaker.

HACR rated.



## Interrupting Ratings

Breaker Type	RMS Symmetrical Amperes (KA)										
	UL 489					IEC 60947-2					
	Volts AC (50/60 Hz)			Volts DC		Volts AC (50/60 Hz)					
	240	480	600Y/347	250	500	220/240		380/415		690	
					I <sub>CU</sub>	I <sub>CS</sub>	I <sub>CU</sub>	I <sub>CS</sub>	I <sub>CU</sub>	I <sub>CS</sub>	
NFG	65	35	18	30	18	65	65	40	40	12	6
HFG	100	65	18	30	18	100	75	70	70	12	6
LFG	200	100	18	30	18	200	150	100	75	12	6

## Connectors for 75°C Wire

Construction	Ampere Rating	Wire Range	No. of cables per connector	Catalog Number
Steel	50-250	#4-350 kcmil Cu	1	3TW1FG350 <sup>②</sup>
Aluminum <sup>①</sup>	50-250	#4-350 kcmil Al/Cu	1	3TAW1FG350 <sup>②</sup>
Copper	50-250	#4-350 kcmil Cu	1	3TCW1FG350 <sup>②</sup>
Distribution Lugs				
	50-250	#12-2/0 Cu/Al	3	3TA3FG20 <sup>②</sup>
	50-250	#14-#4 Cu/Al	6	3TA6FG04 <sup>②</sup>

<sup>①</sup> Standard connector supplied with complete breakers.

<sup>②</sup> Kit consists of 3 terminal connectors.

<sup>③</sup> 2 Lugs for 2-pole breakers.

<sup>④</sup> 3 Lugs for 3-pole breakers.

## FG Thermal-Magnetic, Instantaneous Trip Adjustment Range

Trip Unit Continuous Amp Rating (I <sub>n</sub> )	Instantaneous Overcurrent Setting (I <sub>a</sub> )	
	Min.	Max.
100	625	1250
110	800	1600
125	800	1600
150	800	1600
175	1000	2000
200	1000	2000
225	1250	2500
250	1250	2500

**Note:** Each breaker has 6 trip settings in this range.

## Dimensions, inches (mm)

Number of Poles	Width	Length	Depth	To Handle D1
2, 3	4.1 (105)	6.9 (175)	3.4 (81)	4.2 (107)

## Shipping Weight, lbs. (kg)

Poles	Frame	Trip Unit		Complete Breaker
		Thermal-Mag.	Electronic	
2, 3	4.0 (1.8)	2.2 (1.0)	2.6 (1.2)	6.2 (2.8)

# VL Circuit Breakers

FG 250A Thermal-Magnetic Trip Unit

Selection

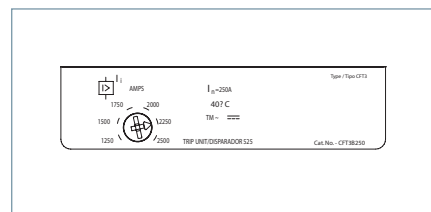

Model 525 Trip Unit

## FG 250A Frame 2-Pole with Thermal-Magnetic Trip Unit

Continuous Ampere Rating	COMPLETE FACTORY ASSEMBLED CIRCUIT BREAKER		
	N-Interrupting Class	H-Interrupting Class	L-Interrupting Class
	Catalog Number	Catalog Number	Catalog Number
100	NFK2B100L	HFK2B100L	LFK2B100L
110	NFK2B110L	HFK2B110L	LFK2B110L
125	NFK2B125L	HFK2B125L	LFK2B125L
150	NFK2B150L	HFK2B150L	LFK2B150L
175	NFK2B175L	HFK2B175L	LFK2B175L
200	NFK2B200L	HFK2B200L	LFK2B200L
225	NFK2B225L	HFK2B225L	LFK2B225L
250	NFK2B250L	HFK2B250L	LFK2B250L

## FG 250A Frame 3-Pole with Thermal-Magnetic Trip Unit

Continuous Ampere Rating	COMPLETE FACTORY ASSEMBLED CIRCUIT BREAKER		
	N-Interrupting Class	H-Interrupting Class	L-Interrupting Class
	Catalog Number	Catalog Number	Catalog Number
100	NFK3B100L	HFK3B100L	LFK3B100L
110	NFK3B110L	HFK3B110L	LFK3B110L
125	NFK3B125L	HFK3B125L	LFK3B125L
150	NFK3B150L	HFK3B150L	LFK3B150L
175	NFK3B175L	HFK3B175L	LFK3B175L
200	NFK3B200L	HFK3B200L	LFK3B200L
225	NFK3B225L	HFK3B225L	LFK3B225L
250	NFK3B250L	HFK3B250L	LFK3B250L

7  
MOLDED CASE  
CIRCUIT BREAKERS

# VL Circuit Breakers

FG 250A Electronic Trip Units

Selection

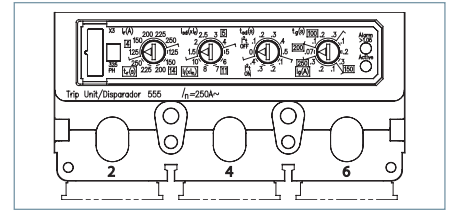
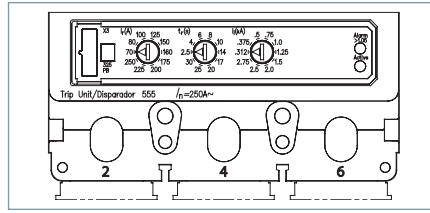

Model 555 Trip Units

## FG 250A Frame 3-Pole Electronic Trip Unit<sup>①</sup>

Continuous Ampere Rating	COMPLETE FACTORY ASSEMBLED CIRCUIT BREAKER		
	N-Interrupting Class	H-Interrupting Class	L-Interrupting Class
	Catalog Number	Catalog Number	Catalog Number
ELECTRONIC LI TRIP			
100	NFK3R100L	HFK3R100L	LFK3R100L
150	NFK3R150L	HFK3R150L	LFK3R150L
250	NFK3R250L	HFK3R250L	LFK3R250L
ELECTRONIC LSI TRIP			
100	NFK3T100L	HFK3T100L	LFK3T100L
150	NFK3T150L	HFK3T150L	LFK3T150L
250	NFK3T250L	HFK3T250L	LFK3T250L
ELECTRONIC LSIG TRIP			
100	NFK3V100L	HFK3V100L	LFK3V100L
150	NFK3V150L	HFK3V150L	LFK3V150L
250	NFK3V250L	HFK3V250L	LFK3V250L
ELECTRONIC LIG TRIP			
100	NFK3W100L	HFK3W100L	LFK3W100L
150	NFK3W150L	HFK3W150L	LFK3W150L
250	NFK3W250L	HFK3W250L	LFK3W250L

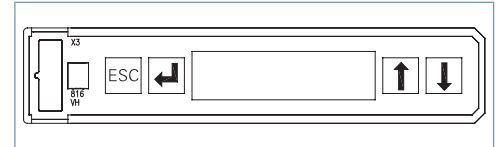

Model 586 Trip Unit

## FG 250A Frame 3-Pole Electronic LCD Trip Unit<sup>①</sup>

Continuous Ampere Rating	COMPLETE FACTORY ASSEMBLED CIRCUIT BREAKER		
	N-Interrupting Class	H-Interrupting Class	L-Interrupting Class
	Catalog Number	Catalog Number	Catalog Number
LCD ELECTRONIC LSI TRIP			
100	NFK3A100L	HFK3A100L	LFK3A100L
150	NFK3A150L	HFK3A150L	LFK3A150L
250	NFK3A250L	HFK3A250L	LFK3A250L
LCD ELECTRONIC LSIG TRIP			
100	NFK3G100L	HFK3G100L	LFK3G100L
150	NFK3G150L	HFK3G150L	LFK3G150L
250	NFK3G250L	HFK3G250L	LFK3G250L
LCD ELECTRONIC LSI TRIP + GF ALARM ONLY			
100	NFK3K100L	HFK3K100L	LFK3K100L
150	NFK3K150L	HFK3K150L	LFK3K150L
250	NFK3K250L	HFK3K250L	LFK3K250L

<sup>①</sup> Due to the location of the magnetic tripping solenoid, the left accessory pocket is not available for accessories.

MOLDED CASE  
CIRCUIT BREAKERS

# VL Circuit Breakers

Internal Accessories for DG 150A and FG 250A Frames

Selection

## Auxiliary Switch and Alarm Switch Combination Kits

Description	Mounting Pocket <sup>①</sup>	Catalog Number
1 Alarm Switch 1A/B <sup>③</sup> Bases AMBL2 & AMBL3	Left, Right <sup>②</sup>	ASKL1
2 Aux. Switches 1A + 1B Bases AMBL1	Left, Right	ASKL2
2 Aux. + 1 Alarm Switches 1A + 1B, 1A/B <sup>③</sup> Bases AMBL2 & AMBL3	Left, Right <sup>②</sup>	ASKL3

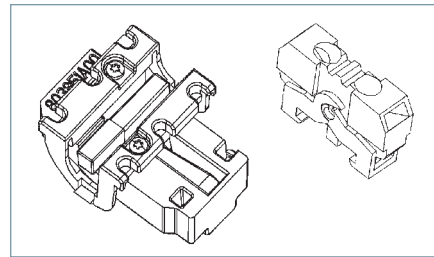

## Auxiliary/Alarm Switch Mounting Base Only

Description	Mounting Pocket	Catalog Number
Up to 3 Auxiliary Switches	Left, Right	AMBL1
2 Aux. + 1 Alarm Switch	Left Pocket Only	AMBL2
2 Aux. + 1 Alarm Switch	Right Pocket Only	AMBL3

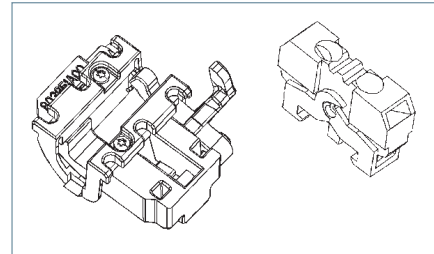

## Auxiliary/Alarm Switch Only

Common to DG - PG Frames

Description	Catalog Number
1 Normally Open Contact (1A)	ASWPA
1 Normally Closed Contact (1B)	ASWPB

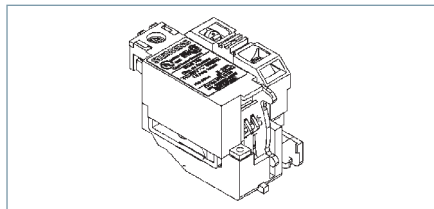

## Shunt Trips

Description	Mounting Pocket	Catalog Number
24 VDC	Right Pocket Only	STRLB24DC
48-60 VDC		STRLC60DC
110-127 VDC		STRLD125DC
220-250 VDC		STRLE250DC
48-60 VAC		STRLM60
110-127 VAC		STRLN120
208-277 VAC		STRLS277
380-600 VAC		STRLV600



## Undervoltage Release

Description	Mounting Pocket	Catalog Number
12 VDC	Right Pocket Only	UVRLA12DC
24 VDC		UVRLB24DC
48 VDC		UVRLC48DC
60 VDC		UVRLG60DC
110-127 VDC		UVRLD125DC
220-250 VDC		UVRLE250DC
24 VAC		UVRL24
110-127 VAC		UVRLN120
220-240 VAC		UVRLR240
208 VAC		UVRLP208
277 VAC		UVRLS277
380-415 VAC		UVRLT415
440-480 VAC		UVRLU480

① Refer to the "Accessory Locations" chart on page 7-202 for guidelines and limitations about which pockets may be used for accessory combinations.  
 ② These kits include two bases, one for mounting switches in the left pocket and another for mounting in the right.  
 ③ Includes 1A and 1B contact for alarm purposes, only one of which may be installed at any time.  
 'A' refers to a normally open contact (open when the breaker contacts are open).  
 'B' refers to a normally closed contact (closed when the breaker contacts are open).

External Accessories pages 7-187 through 7-201

# VL Circuit Breakers

JG 400A Frame, VL Series

Selection/Dimensions

## Ordering Information

### Complete Assembled Breaker

A complete factory assembled JG breaker includes the frame, trip unit, and standard line and load connectors, all factory installed and shipped as a complete breaker. Assembled breakers are available only with standard connectors.

For any other configuration, order the frame, trip unit, and terminals as separate items.

For DC applications, use thermal magnetic trip unit only.

For reverse feed applications, select non-interchangeable trip breakers only. For non-interchangeable trip breakers, change the third digit of the catalog number to "X" for standard breakers.

For 100% rated breakers with a non-interchangeable trip unit, change the 3<sup>rd</sup> character of the catalog number to "Y" (3-pole only).

For special applications, refer to page 7-206.

Mounting hardware is included with each frame or complete breaker. HACR rated.



Dimensions, inches (mm)

Number of Poles	Width	Length	Depth	To Handle D1
2, 3	5.5 (139)	11 (279)	4.2 (102)	5.4 (138)

Shipping Weight, lbs. (kg)

Poles	Frame	Trip Unit		Complete Breaker
		Thermal-Mag.	Electronic	
2, 3	9.3 (4.2)	4.0 (1.8)	4.0 (1.8)	12.6 (5.7)

## Interrupting Ratings

Interrupting Class	Breaker Type	RMS Symmetrical Amperes (KA)										
		UL 489 AIR (File E10848)					IEC 60947-2					
		Volts AC (50/60 Hz)			Volts DC		Volts AC (50/60 Hz)					
		240	480	600	250	500	220/240		380/415		690	
					I <sub>cu</sub>	I <sub>cs</sub>	I <sub>cu</sub>	I <sub>cs</sub>	I <sub>cu</sub>	I <sub>cs</sub>		
N	NJGA	65	35	25	30	25	65	65	45	45	12	6
H	HJGA	100	65	25	30	35	100	75	70	70	15	8
L	LJGA	200	100	25	30	35	200	150	100	75	15	8

## Connectors for 75°C Wire

Construction	Ampere Rating	Wire Range	No. of cables per connector	Catalog Number
Steel	70-400	1/0-600 kcmil Cu	1	3TW1JG600 <sup>②</sup>
Aluminum	70-400	3/0-250 kcmil Al/Cu	2	3TA2JG250 <sup>①②</sup>
Aluminum	70-400	250-750 kcmil Al	1	3TA1JG750 <sup>②</sup>
Aluminum	70-400	3/0-600 kcmil Cu	1	3TA1JG750 <sup>②</sup>
Copper	70-400	3/0-600 kcmil Cu	1	TC1JG750 <sup>③</sup>
Copper	70-400	3/0-250 kcmil Cu	2	TC2JG250 <sup>③</sup>
<b>Distribution Lugs</b>				
	70-400	#14-4 Cu	12	3TA12JG04 <sup>②</sup>
	70-400	#14-2/0 Al/Cu	6	3TA6JG20 <sup>②</sup>
<b>Compression Lugs</b>				
	70-400	#6-350 kcmil	—	3CLJ350 <sup>②</sup>
	70-400	250-600 kcmil	—	3CLJ600 <sup>②</sup>

① Standard construction supplied for each breaker.

② Kit consists of 3 terminal connectors.

③ Required for 100% rated JG breakers. Requires 90°C Cu cable sized at 75°C ampacity.

## JG Thermal-Magnetic, Instantaneous Trip Adjustment Range

Trip Unit Continuous Amp Rating (I <sub>n</sub> )	Instantaneous Overcurrent Setting (I <sub>i</sub> )	
	Min.	Max.
250	1250	2500
300	1500	3000
350	1750	3500
400	2000	4000

Note: Each breaker has 6 trip settings in this range.

7 MOLDED CASE CIRCUIT BREAKERS

External Accessories pages 7-187 through 7-201

# VL Circuit Breakers

JG 400A Thermal-Magnetic Trip Unit

Selection

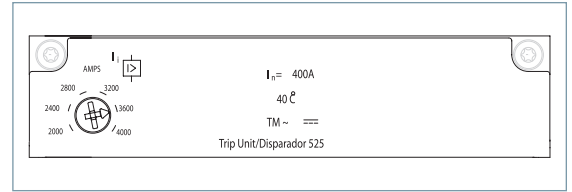

Model 525 Trip Unit

## JG 400A Frame 2-Pole with Thermal-Magnetic Trip Unit

Continuous Ampere Rating	N-Interrupting Class	H-Interrupting Class	L-Interrupting Class	Catalog Number
	Catalog Number	Catalog Number	Catalog Number	
	FRAME ONLY			
	NJG2F400	HJG2F400	LJG2F400	
	COMPLETE FACTORY ASSEMBLED CIRCUIT BREAKER			TRIP UNIT ONLY
250	NJG2B250L	HJG2B250L	LJG2B250L	CJT2B250
300	NJG2B300L	HJG2B300L	LJG2B300L	CJT2B300
350	NJG2B350L	HJG2B350L	LJG2B350L	CJT2B350
400	NJG2B400L	HJG2B400L	LJG2B400L	CJT2B400

## JG 400A Frame 3-Pole with Thermal-Magnetic Trip Unit

Continuous Ampere Rating	N-Interrupting Class	H-Interrupting Class	L-Interrupting Class	Catalog Number
	Catalog Number	Catalog Number	Catalog Number	
	FRAME ONLY			
	NJG3F400	HJG3F400	LJG3F400	
	COMPLETE FACTORY ASSEMBLED CIRCUIT BREAKER			TRIP UNIT ONLY
250	NJG3B250L	HJG3B250L	LJG3B250L	CJT3B250
300	NJG3B300L	HJG3B300L	LJG3B300L	CJT3B300
350	NJG3B350L	HJG3B350L	LJG3B350L	CJT3B350
400	NJG3B400L	HJG3B400L	LJG3B400L	CJT3B400

## JJ 400A Frame 240V max., 2-pole with Thermal-Magnetic Non-Interchangeable Trip Unit<sup>①</sup>

Continuous Ampere Rating	N-Interrupting Class
	Catalog Number
	COMPLETE BREAKER
250	NJJ2B250
300	NJJ2B300
350	NJJ2B350
400	NJJ2B400

## JJ 400A Frame 240V max., 3-pole with Thermal-Magnetic Non-Interchangeable Trip Unit<sup>①</sup>

Continuous Ampere Rating	N-Interrupting Class
	Catalog Number
	COMPLETE BREAKER
250	NJJ3B250
300	NJJ3B300
350	NJJ3B350
400	NJJ3B400

<sup>①</sup> Terminal connectors must be ordered separately.  
Breaker Type NJJA.

# VL Circuit Breakers

JG 400A Electronic Trip Units

Selection

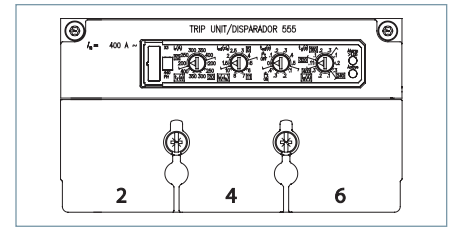
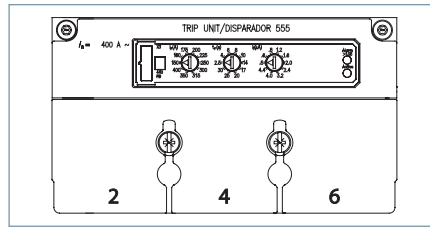

Model 555 Trip Units

## JG 400A Frame 3-Pole Electronic Trip Unit

Continuous Ampere Rating	N-Interrupting Class	H-Interrupting Class	L-Interrupting Class	Catalog Number
	Catalog Number	Catalog Number	Catalog Number	
	FRAME ONLY			
	NJG3F400	HJG3F400	LJG3F400	
COMPLETE FACTORY ASSEMBLED CIRCUIT BREAKER				TRIP UNIT ONLY
ELECTRONIC LI TRIP				
250	NJG3R250L	HJG3R250L	LJG3R250L	CJT3R250
400	NJG3R400L	HJG3R400L	LJG3R400L	CJT3R400
ELECTRONIC LSI TRIP				
250	NJG3T250L	HJG3T250L	LJG3T250L	CJT3T250
400	NJG3T400L	HJG3T400L	LJG3T400L	CJT3T400
ELECTRONIC LSIG TRIP				
250	NJG3V250L	HJG3V250L	LJG3V250L	CJT3V250
400	NJG3V400L	HJG3V400L	LJG3V400L	CJT3V400
ELECTRONIC LIG TRIP				
250	NJG3W250L	HJG3W250L	LJG3W250L	CJT3W250
400	NJG3W400L	HJG3W400L	LJG3W400L	CJT3W400

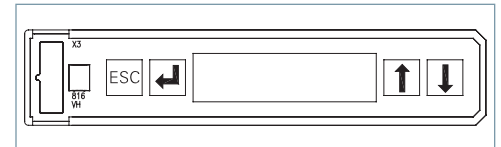

Model 586 Trip Unit

## JG 400A Frame 3-Pole Electronic LCD Trip Unit

Continuous Ampere Rating	N-Interrupting Class	H-Interrupting Class	L-Interrupting Class	Catalog Number
	Catalog Number	Catalog Number	Catalog Number	
	FRAME ONLY			
	NJG3F400	HJG3F400	LJG3F400	
COMPLETE FACTORY ASSEMBLED CIRCUIT BREAKER				TRIP UNIT ONLY
LCD ELECTRONIC LSI TRIP				
250	NJG3A250L	HJG3A250L	LJG3A250L	CJT3A250
400	NJG3A400L	HJG3A400L	LJG3A400L	CJT3A400
LCD ELECTRONIC LSIG TRIP				
250	NJG3G250L	HJG3G250L	LJG3G250L	CJT3G250
400	NJG3G400L	HJG3G400L	LJG3G400L	CJT3G400
LCD ELECTRONIC LSI TRIP + GF ALARM ONLY				
250	NJG3K250L	HJG3K250L	LJG3K250L	CJT3K250
400	NJG3K400L	HJG3K400L	LJG3K400L	CJT3K400

7  
MOLDED CASE  
CIRCUIT BREAKERS

# VL Circuit Breakers

Internal Accessories for JG 400A and LG 600A Frames

Selection

## Auxiliary Switch and Alarm Switch Combination Kits

Description	Mounting Pocket <sup>①</sup>	Catalog Number
1 Alarm Switch 1A/B <sup>③</sup> Bases AMBL2 & AMBL3	Left, Right <sup>②</sup>	ASKL1
2 Aux. Switches 1A + 1B Bases AMBL1	Left, Right	ASKL2
2 Aux. + 1 Alarm Switches 1A + 1B, 1A/B Bases AMBL2 & AMBL3	Left, Right <sup>②</sup>	ASKL3

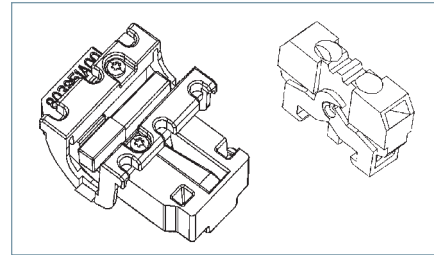

## Auxiliary/Alarm Switch Mounting Base Only

Description	Mounting Pocket	Catalog Number
Up to 3 Auxiliary Switches	Left, Right	AMBL1
2 Aux. + 1 Alarm Switch	Left Pocket Only	AMBL2
2 Aux. + 1 Alarm Switch	Right Pocket Only	AMBL3

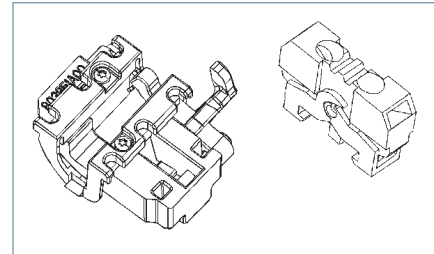

## Auxiliary/Alarm Switch Only

Common to DG - PG Frames

Description	Catalog Number
1 Normally Open Contact (1A)	ASWPA
1 Normally Closed Contact (1B)	ASWPB

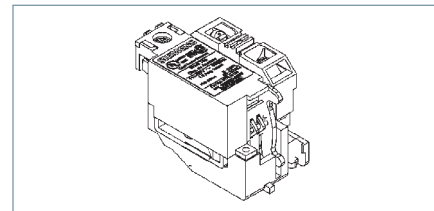

## Shunt Trips

Description	Mounting Pocket	Catalog Number
24 VDC	Right Pocket Only	STRLB24DC
48-60 VDC		STRLC60DC
110-127 VDC		STRLD125DC
220-250 VDC		STRLE250DC
48-60 VAC		STRLM60
110-127 VAC		STRLN120
208-277 VAC		STRLS277
380-600 VAC		STRLV600



UVRLN120

## Undervoltage Release

Description	Mounting Pocket	Catalog Number
12 VDC	Right Pocket Only	UVRLA12DC
24 VDC		UVRLB24DC
48 VDC		UVRLC48DC
60 VDC		UVRLG60DC
110-127 VDC		UVRLD125DC
220-250 VDC		UVRLE250DC
24 VAC		UVRLL24
110-127 VAC		UVRLN120
220-240 VAC		UVRLR240
208 VAC		UVRLP208
277 VAC		UVRLS277
380-415 VAC		UVRLT415
440-480 VAC		UVRLU480

7 MOLDED CASE CIRCUIT BREAKERS

① Refer to the "Accessory Locations" chart on page 7-202 for guidelines and limitations about which pockets may be used for accessory combinations.

② Includes 1A and 1B contact for alarm purposes, only one of which may be installed at any time. 'A' refers to a normally open contact (open when the breaker contacts are open).

'B' refers to a normally closed contact (closed when the breaker contacts are open).

External Accessories pages 7-187 through 7-201



# VL Circuit Breakers

LG 600A Frame, VL Series

Selection/Dimensions

## Ordering Information

### Complete Assembled Breaker

A complete factory assembled LG breaker includes the frame, trip unit, and standard line and load lugs, all factory installed and shipped as a complete breaker. Assembled breakers are available only with standard connectors.

For DC applications, use thermal magnetic trip unit only.

Breakers are suitable for reverse feed applications.

For special applications, refer to page 7-206.

Mounting hardware is included with each breaker.

For 100% rated breakers, change the 3rd character of the catalog number to "W". Available on 400/500 Amp only (3-pole only).

HACR rated.



## Dimensions, inches (mm)

Number of Poles	Width	Length	Depth	To Handle D1
2, 3	5.5 (139)	11 (279)	4.2 (102)	5.4 (138)
Ext. Shield		13.6 (345.5)		

## Shipping Weight, lbs. (kg)

Poles	Frame	Trip Unit		Complete Breaker
		Thermal-Mag.	Electronic	
2, 3	17.4 (7.9)	3.5 (1.6)	4.2 (1.9)	20.9 (9.5)

## Interrupting Ratings

Interrupting Class	Breaker Type	RMS Symmetrical Amperes (KA)										
		UL 489					IEC 60947-2					
		Volts AC (50/60 Hz)			Volts DC		Volts AC (50/60 Hz)					
		240	480	600	250	500	220/240		380/415		690	
						I <sub>cu</sub>	I <sub>cs</sub>	I <sub>cu</sub>	I <sub>cs</sub>	I <sub>cu</sub>	I <sub>cs</sub>	
N	NLGB	65	35	18	30	25	65	65	45	45	12	6
H	HLGB	100	65	18 <sup>①</sup>	30	35	100	75	70	70	15	8
L	LLGB	200	100	18	30	35	200	150	100	75	15	8

① Special 600Vac 25kA thermal-magnetic version (Type HLGC) available, see page 7-170.

## Connectors for 75°C Wire

Construction	Ampere Rating	Wire Range	No. of cables per connector	Catalog Number <sup>③</sup>
Aluminum	150-600	#2-600 kcmil Al/Cu	2 (load side)	3TA2LG600LD <sup>②</sup>
Aluminum	150-600	#2-600 kcmil Al/Cu	2 (line side)	3TA2LG600LN <sup>②</sup>
Copper	150-600	#2-600 kcmil Cu	2 (load side)	3TC2LG600LD <sup>⑤</sup>
Copper	150-600	#2-600 kcmil Cu	2 (line side)	3TC2LG600LN <sup>⑤</sup>
Compression Lugs				
	150-600	#6-350 kcmil Al/Cu	—	6CLL350 <sup>④</sup>
	150-600	250-750 kcmil Al/Cu	—	3CLL750 <sup>③</sup>
	150-600	250-600 kcmil Al/Cu	—	6CLL600 <sup>⑤</sup>

② Standard construction supplied for each breaker.

③ Kit consists of 3 terminal connectors.

④ Kit consists of 6 lugs for Line or Load end.

⑤ Required for 100% rated LG breakers. Requires 90°C Cu cable sized at 75°C ampacity.

## LG Thermal-Magnetic, Instantaneous Trip Adjustment Range

Trip Unit Continuous Amp Rating (I <sub>n</sub> )	Instantaneous Overcurrent Setting (I <sub>t</sub> )	
	Min.	Max.
400	2000	4000
500	2500	5000
600	2750	5500

Note: Each breaker has 6 trip settings.

7  
MOLDED CASE  
CIRCUIT BREAKERS

External Accessories pages 7-187 through 7-201

# VL Circuit Breakers

LG 600A Thermal-Magnetic Trip Unit

Selection

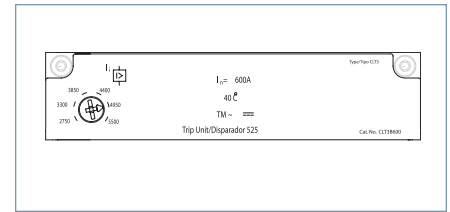

Model 525 Trip Unit

## LG 600A Frame 2-Pole with Thermal-Magnetic Trip Unit

Continuous Ampere Rating	N-Interrupting Class	H-Interrupting Class	L-Interrupting Class
	Catalog Number	Catalog Number	Catalog Number
	COMPLETE FACTORY ASSEMBLED CIRCUIT BREAKER		
400	NLK2B400L	HLK2B400L	LLK2B400L
500	NLK2B500L	HLK2B500L	LLK2B500L
600	NLK2B600L	HLK2B600L	LLK2B600L

## LG 600A Frame 3-Pole with Thermal-Magnetic Trip Unit<sup>①</sup>

Continuous Ampere Rating	N-Interrupting Class	H-Interrupting Class	L-Interrupting Class
	Catalog Number	Catalog Number	Catalog Number
	COMPLETE FACTORY ASSEMBLED CIRCUIT BREAKER		
400	NLK3B400L	HLK3B400L	LLK3B400L
500	NLK3B500L	HLK3B500L	LLK3B500L
600	NLK3B600L	HLK3B600L	LLK3B600L

## Type HLCG 600A Frame 2-Pole with Thermal-Magnetic Trip Unit , 600Vac 25kA only<sup>②</sup>

Continuous Ampere Rating	N-Interrupting Class	H-Interrupting Class	L-Interrupting Class
	Catalog Number	Catalog Number	Catalog Number
	COMPLETE FACTORY ASSEMBLED CIRCUIT BREAKER		
400	—	HLV2B400L	—
500	—	HLV2B500L	—
600	—	HLV2B600L	—

## Type HLCG 600A Frame 3-Pole with Thermal-Magnetic Trip Unit , 600Vac 25kA only<sup>①②</sup>

Continuous Ampere Rating	N-Interrupting Class	H-Interrupting Class	L-Interrupting Class
	Catalog Number	Catalog Number	Catalog Number
	COMPLETE FACTORY ASSEMBLED CIRCUIT BREAKER		
400	—	HLV3B400L	—
500	—	HLV3B500L	—
600	—	HLV3B600L	—

① For 100% rated 400A or 500A versions, change the third character of the catalog number to "Z".

② Consult sales office for availability.

# VL Circuit Breakers

LG 600A Electronic Trip Units

Selection

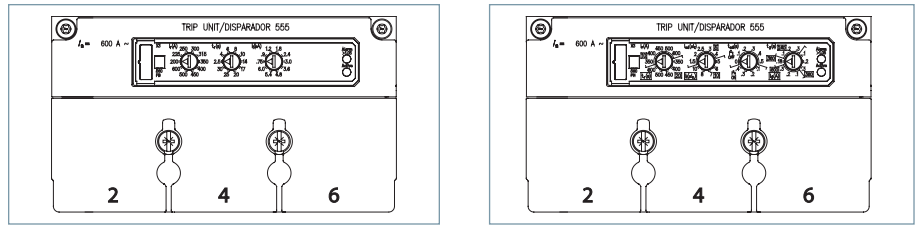

Model 555 Trip Unit

## LG 600A Frame 3-Pole Electronic Trip Unit

Continuous Ampere Rating	N-Interrupting Class	H-Interrupting Class	L-Interrupting Class
	Catalog Number	Catalog Number	Catalog Number
<b>COMPLETE FACTORY ASSEMBLED CIRCUIT BREAKER</b>			
<b>ELECTRONIC LI TRIP</b>			
400	NLK3R400L	HLK3R400L	LLK3R400L
600	NLK3R600L	HLK3R600L	LLK3R600L
<b>ELECTRONIC LSI TRIP</b>			
400	NLK3T400L	HLK3T400L	LLK3T400L
600	NLK3T600L	HLK3T600L	LLK3T600L
<b>ELECTRONIC LSIG TRIP</b>			
400	NLK3V400L	HLK3V400L	LLK3V400L
600	NLK3V600L	HLK3V600L	LLK3V600L
<b>ELECTRONIC LIG TRIP</b>			
400	NLK3W400L	HLK3W400L	LLK3W400L
600	NLK3W600L	HLK3W600L	LLK3W600L

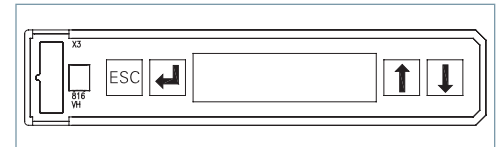

Model 586 Trip Unit

## LG 600A Frame 3-Pole Electronic LCD Trip Unit

Continuous Ampere Rating	N-Interrupting Class	H-Interrupting Class	L-Interrupting Class
	Catalog Number	Catalog Number	Catalog Number
<b>COMPLETE FACTORY ASSEMBLED CIRCUIT BREAKER</b>			
<b>ELECTRONIC LSI TRIP</b>			
400	NLK3A400L	HLK3A400L	LLK3A400L
600	NLK3A600L	HLK3A600L	LLK3A600L
<b>ELECTRONIC LSIG TRIP</b>			
400	NLK3G400L	HLK3G400L	LLK3G400L
600	NLK3G600L	HLK3G600L	LLK3G600L
<b>ELECTRONIC LSI TRIP + GF ALARM ONLY</b>			
400	NLK3K400L	HLK3K400L	LLK3K400L
600	NLK3K600L	HLK3K600L	LLK3K600L

7  
MOLDED CASE  
CIRCUIT BREAKERS

# VL Circuit Breakers

Internal Accessories for JG 400A and LG 600A Frames

Selection

## Auxiliary Switch and Alarm Switch Combination Kits

Description	Mounting Pocket <sup>①</sup>	Catalog Number
1 Alarm Switch 1A/B <sup>③</sup> Bases AMBL2 & AMBL3	Left, Right <sup>②</sup>	ASKL1
2 Aux. Switches 1A + 1B Bases AMBL1	Left, Right	ASKL2
2 Aux. + 1 Alarm Switches 1A + 1B, 1A/B Bases AMBL2 & AMBL3	Left, Right <sup>②</sup>	ASKL3

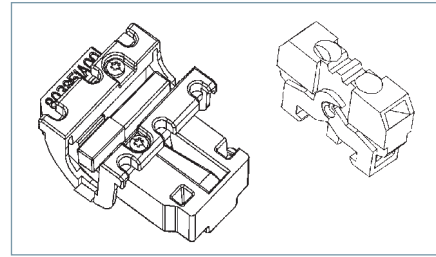

## Auxiliary/Alarm Switch Mounting Base Only

Description	Mounting Pocket	Catalog Number
Up to 3 Auxiliary Switches	Left, Right	AMBL1
2 Aux. + 1 Alarm Switch	Left Pocket Only	AMBL2
2 Aux. + 1 Alarm Switch	Right Pocket Only	AMBL3

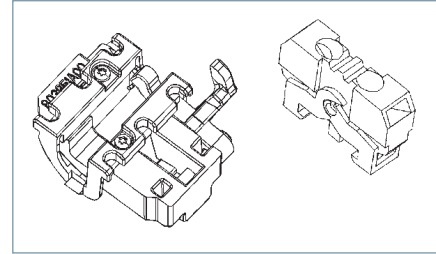

## Auxiliary/Alarm Switch Only

Common to DG - PG Frames

Description	Catalog Number
1 Normally Open Contact (1A)	ASWPA
1 Normally Closed Contact (1B)	ASWPB

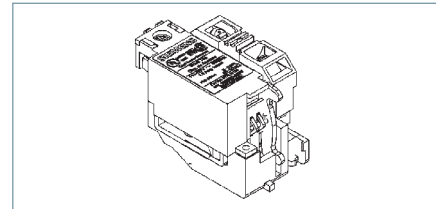

## Shunt Trips

Description	Mounting Pocket	Catalog Number
24 VDC	Right Pocket Only	STRLB24DC
48-60 VDC		STRLC60DC
110-127 VDC		STRLD125DC
220-250 VDC		STRLE250DC
48-60 VAC		STRLM60
110-127 VAC		STRLN120
208-277 VAC		STRLS277
380-600 VAC		STRLV600



## Undervoltage Release

Description	Mounting Pocket	Catalog Number
12 VDC	Right Pocket Only	UVRLA12DC
24 VDC		UVRLB24DC
48 VDC		UVRLC48DC
60 VDC		UVRLG60DC
110-127 VDC		UVRLD125DC
220-250 VDC		UVRLE250DC
24 VAC		UVRL24
110-127 VAC		UVRLN120
220-240 VAC		UVRLR240
208 VAC		UVRLP208
277 VAC		UVRLS277
380-415 VAC		UVRLT415
440-480 VAC		UVRLU480

① Refer to the "Accessory Locations" chart on page 7-202 for guidelines and limitations about which pockets may be used for accessory combinations.  
 ② Includes 1A and 1B contact for alarm purposes, only one of which may be installed at any time.  
 'A' refers to a normally open contact (open when the breaker contacts are open).  
 'B' refers to a normally closed contact (closed when the breaker contacts are open).

External Accessories pages 7-187 through 7-201

# VL Circuit Breakers

MG 800A Frame, VL Series

Selection/Dimensions

## Ordering Information

### Complete Assembled Breaker

A complete factory assembled MG breaker includes the frame, trip unit, and standard line and load lugs, all factory installed and shipped as a complete breaker. Assembled breakers are available only with standard connectors.

For any other configuration, order the frame, trip unit, and terminals as separate items.

For DC applications, use thermal magnetic trip unit only.

For reverse feed applications, select non-interchangeable trip breakers only. For non-interchangeable trip breakers, change the third digit of the catalog number to "X" for standard breakers.

For 100% rated breakers with a non-interchangeable trip unit, change the 3<sup>rd</sup> character of the catalog number to "Y".

For special applications, refer to page 7-206.

Mounting hardware is included with each frame or complete breaker.  
HACR rated.



Dimensions, inches (mm)

Number of Poles	Width	Length	Depth	To Handle D1
2, 3	7.5 (190)	16 (406)	4.7 (119)	5.9 (151)

Shipping Weight, lbs. (kg)

Poles	Frame	Trip Unit	Complete Breaker
2, 3	31.3 (14.2)	4.0 (1.8)	35.3 (16.0)

## Interrupting Ratings

Interrupting Class	Breaker Type	RMS Symmetrical Amperes (KA)										
		UL 489					IEC 60947-2					
		Volts AC (50/60 Hz)			Volts DC		Volts AC (50/60 Hz)					
		240	480	600	250	500	220/240		380/415		690	
					I <sub>cu</sub>	I <sub>cs</sub>	I <sub>cu</sub>	I <sub>cs</sub>	I <sub>cu</sub>	I <sub>cs</sub>		
N	NMG	65	35	25	22	35	65	65	50	50	20	10
H	HMG	100	65	35	25	50	100	75	70	70	30	15
L	LMG	200	100	50	42	65	200	150	100	75	35	17

## Connectors for 75°C Wire

Construction	Ampere Rating	Wire Range	No. of cables per connector	Catalog Number
Aluminum	200-800A	1/0-500 kcmil Al/Cu	3	3TA3MG500 <sup>①②</sup>
Aluminum	200-800A	500-750 kcmil Al/Cu	2	3TA2MG750 <sup>②</sup>
Copper	200-800A	1/0-500 kcmil Cu	3	TC3MG500 <sup>③⑤</sup>
Aluminum	200-800A	#2-600 kcmil Al/Cu	3	3TA3MG600 <sup>②④</sup>

① Standard connector supplied with complete breakers.

② Kit consists of 3 terminal connectors.

③ Consists of one terminal.

④ Includes extended terminal cover.

⑤ Required for 100% rated MG breakers. Requires 90°C Cu cable sized at 75°C ampacity.

## MG Thermal-Magnetic, Instantaneous Trip Adjustment Range

Trip Unit Continuous Amp Rating (I <sub>n</sub> )	Instantaneous Overcurrent Setting (I <sub>t</sub> )	
	Min.	Max.
600	3000	6000
700	3250	6500
800	3250	6500

Note: Each breaker has 6 trip settings.

7  
MOLDED CASE  
CIRCUIT BREAKERS

External Accessories pages 7-187 through 7-201

# VL Circuit Breakers

MG 800A Thermal-Magnetic Trip Unit

Selection

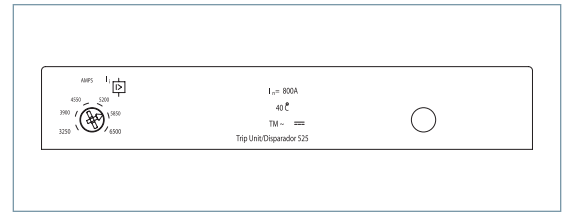

Model 525 Trip Unit

## MG 800A Frame 2-Pole with Thermal-Magnetic Trip Unit

Continuous Ampere Rating	N-Interrupting Class	H-Interrupting Class	L-Interrupting Class	TRIP UNIT ONLY	
	Catalog Number	Catalog Number	Catalog Number		Catalog Number
	FRAME ONLY				
	NMG2F800	HMG2F800	LMG2F800		
	COMPLETE FACTORY ASSEMBLED CIRCUIT BREAKER				
600	NMG2B600L	HMG2B600L	LMG2B600L	CMT2B600	
700	NMG2B700L	HMG2B700L	LMG2B700L	CMT2B700	
800	NMG2B800L	HMG2B800L	LMG2B800L	CMT2B800	

## MG 800A Frame 3-Pole with Thermal-Magnetic Trip Unit

Continuous Ampere Rating	N-Interrupting Class	H-Interrupting Class	L-Interrupting Class	TRIP UNIT ONLY	
	Catalog Number	Catalog Number	Catalog Number		Catalog Number
	FRAME ONLY				
	NMG3F800	HMG3F800	LMG3F800		
	COMPLETE FACTORY ASSEMBLED CIRCUIT BREAKER				
600	NMG3B600L	HMG3B600L	LMG3B600L	CMT3B600	
700	NMG3B700L	HMG3B700L	LMG3B700L	CMT3B700	
800	NMG3B800L	HMG3B800L	LMG3B800L	CMT3B800	

7

MOLDED CASE  
CIRCUIT BREAKERS

# VL Circuit Breakers

MG 800A Electronic Trip Units

Selection

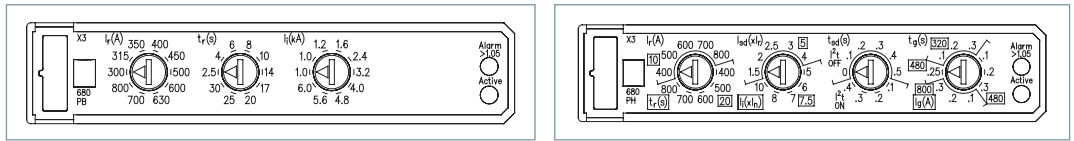

Model 555 Trip Units

## MG 800A Frame 3-Pole Electronic Trip Unit

Continuous Ampere Rating	N-Interrupting Class	H-Interrupting Class	L-Interrupting Class	Catalog Number
	Catalog Number	Catalog Number	Catalog Number	
	FRAME ONLY			
	NMG3F800	HMG3F800	LMG3F800	
COMPLETE FACTORY ASSEMBLED CIRCUIT BREAKER				TRIP UNIT ONLY
ELECTRONIC LI TRIP				
600	NMG3R600L	HMG3R600L	LMG3R600L	CMT3R600
800	NMG3R800L	HMG3R800L	LMG3R800L	CMT3R800
ELECTRONIC LSI TRIP				
600	NMG3T600L	HMG3T600L	LMG3T600L	CMT3T600
800	NMG3T800L	HMG3T800L	LMG3T800L	CMT3T800
ELECTRONIC LSIG TRIP				
600	NMG3V600L	HMG3V600L	LMG3V600L	CMT3V600
800	NMG3V800L	HMG3V800L	LMG3V800L	CMT3V800
ELECTRONIC LIG TRIP				
600	NMG3W600L	HMG3W600L	LMG3W600L	CMT3W600
800	NMG3W800L	HMG3W800L	LMG3W800L	CMT3W800

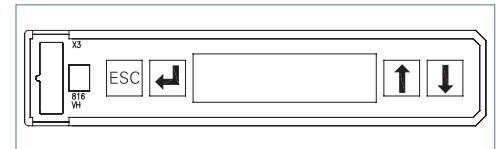

Model 586 Trip Unit

## MG 800A Frame 3-Pole Electronic LCD Trip Unit

Continuous Ampere Rating	N-Interrupting Class	H-Interrupting Class	L-Interrupting Class	Catalog Number
	Catalog Number	Catalog Number	Catalog Number	
	FRAME ONLY			
	NMG3F800	HMG3F800	LMG3F800	
COMPLETE FACTORY ASSEMBLED CIRCUIT BREAKER				TRIP UNIT ONLY
LCD ELECTRONIC LSI TRIP				
600	NMG3A600L	HMG3A600L	LMG3A600L	CMT3A600
800	NMG3A800L	HMG3A800L	LMG3A800L	CMT3A800
LCD ELECTRONIC LSIG TRIP				
600	NMG3G600L	HMG3G600L	LMG3G600L	CMT3G600
800	NMG3G800L	HMG3G800L	LMG3G800L	CMT3G800
LCD ELECTRONIC LSI TRIP + GF ALARM ONLY				
600	NMG3K600L	HMG3K600L	LMG3K600L	CMT3K600
800	NMG3K800L	HMG3K800L	LMG3K800L	CMT3K800

7  
MOLDED CASE  
CIRCUIT BREAKERS

# VL Circuit Breakers

Internal Accessories for MG 800A, NG 1200A and PG 1600A Frames

Selection

## Auxiliary Switch and Alarm Switch Combination Kits

Description	Mounting Pocket <sup>①</sup>	Catalog Number
2 Aux. + 2 Alarm Switches 2A + 2B Bases AMBP2	Left Pocket Only	ASKP3
4 Aux. Switches 2A + 2B Bases AMBP1	Left, Right	ASKP4

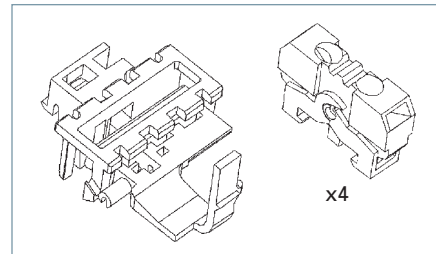

## Auxiliary/Alarm Switch Mounting Base Only

Description	Mounting Pocket	Catalog Number
Up to 4 Auxiliary Switches	Left, Right	AMBP1
2 Aux. + 2 Alarm Switches	Left Pocket Only	AMBP2

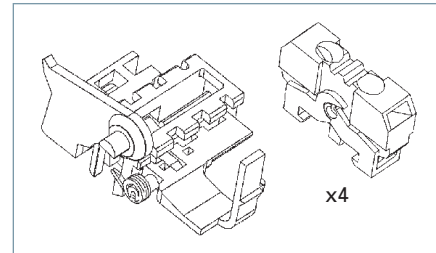

## Auxiliary/Alarm Switch Only

Common to DG - PG Frames

Description	Catalog Number
1 Normally Open Contact (1A)	ASWPA
1 Normally Closed Contact (1B)	ASWPB

## Shunt Trips

Description	Mounting Pocket	Catalog Number
24 VDC	Right Pocket Only	STRPB24DC
48-60 VDC		STRPC60DC
110-127 VDC		STRPD125DC
220-250 VDC		STRPE250DC
48-60 VAC		STRPM60
110-127 VAC		STRPN120
208-277 VAC		STRPS277
380-600 VAC		STRPV600



## Undervoltage Release

Description	Mounting Pocket	Catalog Number
12 VDC	Right Pocket Only	UVRPA12DC
24 VDC		UVRPB24DC
48 VDC		UVRPC48DC
60 VDC		UVRPG60DC
110-127 VDC		UVRPD125DC
220-250 VDC		UVRPE250DC
110-127 VAC		UVRPN120
220-240 VAC		UVRPR240
208 VAC		UVRPP208
277 VAC		UVRPS277
380-415 VAC		UVRPT415
440-480 VAC		UVRPU480

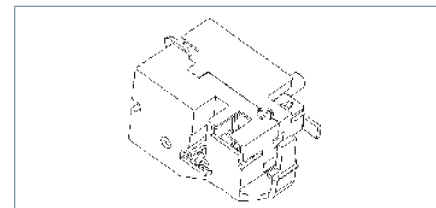

<sup>①</sup> Refer to the "Accessory Locations" chart on page 7-202 for guidelines and limitations about which pockets may be used for accessory combinations.

'A' refers to a normally open contact (open when the breaker contacts are open).

'B' refers to a normally closed contact (closed when the breaker contacts are open).



# VL Circuit Breakers

NG 1200A Frame, VL Series

Selection/Dimensions

## Ordering Information

### Complete Assembled Breaker with Lugs

A complete factory assembled NG breaker includes the frame, trip unit, and standard line and load lugs, all factory installed and shipped as a complete breaker. Assembled breakers are available only with standard connectors.

For any other configuration, order the frame, trip unit, and terminals as separate items.

For DC applications, use thermal magnetic trip unit only.

For reverse feed applications, select non-interchangeable trip breakers only. For non-interchangeable trip breakers, change the third digit of the catalog number to "X" for standard breakers.

For 100% rated breakers with a non-interchangeable trip unit, change the 3<sup>rd</sup> character of the catalog number to "Y".

For special applications, refer to page 7-206.

Mounting hardware is included with each frame or complete breaker.

A Toggle Handle Extension is included with each frame or complete breaker.

HACR rated.



## Dimensions, inches (mm)

Number of Poles	W	L	D	To Handle D1
2, 3	9 (229)	16 (406)	6 (152)	8.1 (207)

## Shipping Weight, lbs. (kg)

Poles	Frame	Trip Unit	Complete Breaker
2, 3	46.3 (21.0)	8.8 (4.0)	55.1 (25.0)

## Interrupting Ratings

Interrupting Class	Breaker Type	RMS Symmetrical Amperes (KA)										
		UL 489					IEC 60947-2					
		Volts AC (50/60 Hz)			Volts DC		Volts AC (50/60 Hz)					
		240	480	600	250	500	220/240		380/415		690	
						I <sub>cu</sub>	I <sub>cs</sub>	I <sub>cu</sub>	I <sub>cs</sub>	I <sub>cu</sub>	I <sub>cs</sub>	
N	NNG	65	35	25	22	35	65	35	50	25	20	10
H	HNG	100	65	35	25	50	100	50	70	35	30	15
L	LNG	200	100	65	42	65	200	100	100	50	35	17

## Connectors for 75°C Wire

Construction	Ampere Rating	Wire Range	No. of cables per connector	Catalog Number
Aluminum	300-1200A	1/0-500 kcmil Al/Cu	4	3TA4NG500 <sup>③④</sup>
Aluminum	300-1200A	500-750 kcmil Al/Cu	3	3TA3NG750 <sup>④</sup>
Copper	300-1200A	1/0-500 kcmil Cu	4	3TC4NG500 <sup>②④</sup>
Aluminum	300-1200A	1/0-500 kcmil Al/Cu	4	3TA4NG500H <sup>②④</sup>
Compression Lugs				
	300-1200A	1/0-500 kcmil Al/Cu	—	12CLN500 <sup>①</sup>

① Total of 12 connectors (4 per phase Line or Load).

② For 100% rated NG breakers. Requires 90°C Cu cable sized at 75°C ampacity.

③ Standard connector provided with complete breakers.

④ Kit consists of 3 terminal connectors.

## NG Thermal-Magnetic, Instantaneous Trip Adjustment Range

Trip Unit Continuous Amp Rating (I <sub>n</sub> )	Instantaneous Overcurrent Setting (I <sub>b</sub> )	
	Min.	Max.
800	4000	8000
900	5000	10000
1000	5000	10000
1200	7000	12000

Note: Each breaker has 6 trip settings.

7 MOLDED CASE CIRCUIT BREAKERS

External Accessories pages 7-187 through 7-201

# VL Circuit Breakers

NG 1200A Thermal-Magnetic Trip Unit

Selection

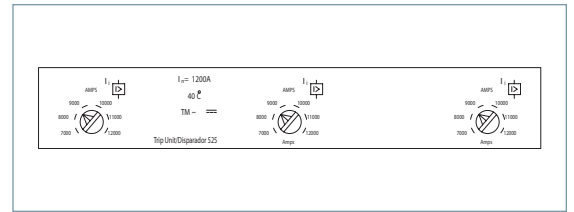

Model 525 Trip Unit

## NG 1200A Frame 2-Pole with Thermal-Magnetic Trip Unit

Continuous Ampere Rating	N-Interrupting Class	H-Interrupting Class	L-Interrupting Class	
	Catalog Number	Catalog Number	Catalog Number	Catalog Number
	FRAME ONLY			TRIP UNIT ONLY
	NNG2F120	HNG2F120	LNG2F120	
	COMPLETE FACTORY ASSEMBLED CIRCUIT BREAKER			
800	NNG2B800L	HNG2B800L	LNG2B800L	CNT2B800
900	NNG2B900L	HNG2B900L	LNG2B900L	CNT2B900
1000	NNG2B100L	HNG2B100L	LNG2B100L	CNT2B100
1200	NNG2B120L	HNG2B120L	LNG2B120L	CNT2B120

## NG 1200A Frame 3-Pole with Thermal-Magnetic Trip Unit

Continuous Ampere Rating	N-Interrupting Class	H-Interrupting Class	L-Interrupting Class	
	Catalog Number	Catalog Number	Catalog Number	Catalog Number
	FRAME ONLY			TRIP UNIT ONLY
	NNG3F120	HNG3F120	LNG3F120	
	COMPLETE FACTORY ASSEMBLED CIRCUIT BREAKER			
800	NNG3B800L	HNG3B800L	LNG3B800L	CNT3B800
900	NNG3B900L	HNG3B900L	LNG3B900L	CNT3B900
1000	NNG3B100L	HNG3B100L	LNG3B100L	CNT3B100
1200	NNG3B120L	HNG3B120L	LNG3B120L	CNT3B120

# VL Circuit Breakers

## NG 1200A Electronic Trip Units

Selection

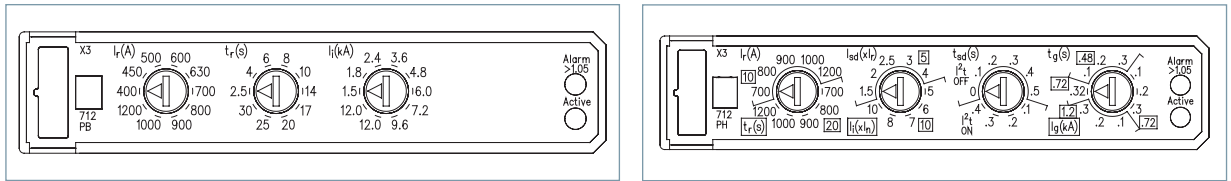

Model 555 Trip Units

## NG 1200A Frame 3-Pole Electronic Trip Unit

Continuous Ampere Rating	N-Interrupting Class	H-Interrupting Class	L-Interrupting Class	Catalog Number
	Catalog Number	Catalog Number	Catalog Number	
	FRAME ONLY			
	NNG3F120	HNG3F120	LNG3F120	
COMPLETE FACTORY ASSEMBLED CIRCUIT BREAKER				TRIP UNIT ONLY
<b>ELECTRONIC LI TRIP</b>				
800	NNG3R800L	HNG3R800L	LNG3R800L	CNT3R800
1000	NNG3R100L	HNG3R100L	LNG3R100L	CNT3R100
1200	NNG3R120L	HNG3R120L	LNG3R120L	CNT3R120
<b>ELECTRONIC LSI TRIP</b>				
800	NNG3T800L	HNG3T800L	LNG3T800L	CNT3T800
1000	NNG3T100L	HNG3T100L	LNG3T100L	CNT3T100
1200	NNG3T120L	HNG3T120L	LNG3T120L	CNT3T120
<b>ELECTRONIC LSIG TRIP</b>				
800	NNG3V800L	HNG3V800L	LNG3V800L	CNT3V800
1000	NNG3V100L	HNG3V100L	LNG3V100L	CNT3V100
1200	NNG3V120L	HNG3V120L	LNG3V120L	CNT3V120
<b>ELECTRONIC LIG TRIP</b>				
800	NNG3W800L	HNG3W800L	LNG3W800L	CNT3W800
1000	NNG3W100L	HNG3W100L	LNG3W100L	CNT3W100
1200	NNG3W120L	HNG3W120L	LNG3W120L	CNT3W120

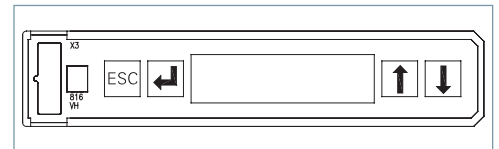

Model 586 Trip Unit

## NG 1200A Frame 3-Pole Electronic LCD Trip Unit

Continuous Ampere Rating	N-Interrupting Class	H-Interrupting Class	L-Interrupting Class	Catalog Number
	Catalog Number	Catalog Number	Catalog Number	
	FRAME ONLY			
	NNG3F120	HNG3F120	LNG3F120	
COMPLETE FACTORY ASSEMBLED CIRCUIT BREAKER				TRIP UNIT ONLY
<b>LCD ELECTRONIC LSI TRIP</b>				
800	NNG3A800L	HNG3A800L	LNG3A800L	CNT3A800
1000	NNG3A100L	HNG3A100L	LNG3A100L	CNT3A100
1200	NNG3A120L	HNG3A120L	LNG3A120L	CNT3A120
<b>LCD ELECTRONIC LSIG TRIP</b>				
800	NNG3G800L	HNG3G800L	LNG3G800L	CNT3G800
1000	NNG3G100L	HNG3G100L	LNG3G100L	CNT3G100
1200	NNG3G120L	HNG3G120L	LNG3G120L	CNT3G120
<b>LCD ELECTRONIC LSI TRIP + GF ALARM ONLY</b>				
800	NNG3K800L	HNG3K800L	LNG3K800L	CNT3K800
1000	NNG3K100L	HNG3K100L	LNG3K100L	CNT3K100
1200	NNG3K120L	HNG3K120L	LNG3K120L	CNT3K120

7 MOLDED CASE CIRCUIT BREAKERS

# VL Circuit Breakers

Internal Accessories for MG 800A, NG 1200A, and PG 1600A Frames

Selection

## Auxiliary Switch and Alarm Switch Combination Kits

Description	Mounting Pocket <sup>①</sup>	Catalog Number
2 Aux. + 2 Alarm Switches 2A + 2B Base AMBP2	Left Pocket Only	<b>ASKP3</b>
4 Aux. Switches 2A + 2B Base AMBP1	Left, Right	<b>ASKP4</b>

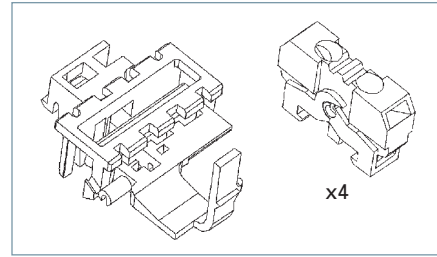

## Auxiliary/Alarm Switch Mounting Base Only

Description	Mounting Pocket <sup>①</sup>	Catalog Number
Up to 4 Auxiliary Switches 2 Aux. + 2 Alarm Switches	Left, Right Left Pocket Only	<b>AMBP1</b> <b>AMBP2</b>

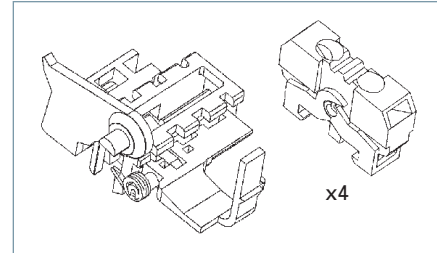

## Auxiliary/Alarm Switch Only

Common to DG-PG Frames

Description	Catalog Number
1 Normally Open Contact (1A)	<b>ASWPA</b>
1 Normally Closed Contact (1B)	<b>ASWPB</b>

## Shunt Trips

Description	Mounting Pocket	Catalog Number
24 VDC	Right Pocket Only	<b>STRPB24DC</b>
48-60 VDC		<b>STRPC60DC</b>
110-127 VDC		<b>STRPD125DC</b>
220-250 VDC		<b>STRPE250DC</b>
48-60 VAC		<b>STRPM60</b>
110-127 VAC		<b>STRPN120</b>
208-277 VAC		<b>STRPS277</b>
380-600 VAC		<b>STRPV600</b>



## Undervoltage Release

Description	Mounting Pocket	Catalog Number
12 VDC	Right Pocket Only	<b>UVRPA12DC</b>
24 VDC		<b>UVRPB24DC</b>
48 VDC		<b>UVRPC48DC</b>
60 VDC		<b>UVRPG60DC</b>
110-127 VDC		<b>UVRPD125DC</b>
220-250 VDC		<b>UVRPE250DC</b>
110-127 VAC		<b>UVRPN120</b>
220-240 VAC		<b>UVRPR240</b>
208 VAC		<b>UVRPP208</b>
277 VAC		<b>UVRPS277</b>
380-415 VAC		<b>UVRPT415</b>
440-480 VAC		<b>UVRPU480</b>

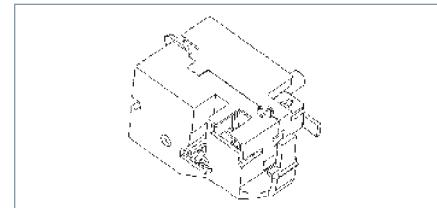

① Refer to the "Accessory Locations" chart on page 7-202 for guidelines and limitations about which pockets may be used for accessory combinations.

'A' refers to a normally open contact (open when the breaker contacts are open).

'B' refers to a normally closed contact (closed when the breaker contacts are open).

# VL Circuit Breakers

PG 1600A Frame, VL Series & Thermal-Magnetic Trip Unit

Selection/Dimensions

## Ordering Information

A complete factory assembled PG breaker includes the frame and trip unit only. The connectors must be ordered as separate items.

PG thermal-magnetic breakers sold as non-interchangeable only.

For any other configuration, order the frame, trip unit, and connectors as separate items.

Connectors require a Breaker Lug Mounting Assembly or Breaker Mounting Base and must be ordered as a separate item.

For DC applications, use Thermal magnetic trip unit only.

For reverse feed applications select non-interchangeable trip breakers only. Change the third digit of the catalog number to "X" for non-interchangeable trip breakers.

For 100% rated breakers with a non-interchangeable trip unit, change the 3<sup>rd</sup> character of the catalog number to "Y".

For special applications, refer to page 7-206.

Mounting hardware is included with each frame or complete breaker.

A Toggle Handle Extension is included with each frame or complete breaker.



Dimensions, inches (mm)

Number of Poles	W	L	D	To Handle D1
2, 3	9 (229)	16 (406)	6 (152)	8.1 (207)

Shipping Weight, lbs. (kg)

Poles	Frame	Trip Unit	Complete Breaker
2, 3	60.2 (27.3)	8.8 (4.0)	69.0 (31.3)

PG Thermal-Magnetic, Instantaneous Trip Adjustment Range

Trip Unit Continuous Amp Rating (I <sub>n</sub> )	Instantaneous Overcurrent Setting (I <sub>t</sub> )	
	Min.	Max.
1200	7000	12000
1400	7000	12000
1600	7000	12000

Note: Each breaker has 6 trip settings in this range.

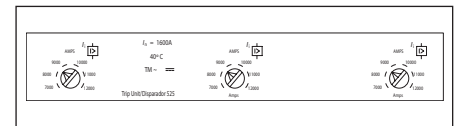

Model 525 Trip Unit

## Interrupting Ratings

Interrupting Class	Breaker Type	RMS Symmetrical Amperes (KA)										
		UL 489					IEC 60947-2 <sup>®</sup> (ETU only)					
		Volts AC (50/60 Hz)			Volts DC		Volts AC (50/60 Hz)					
		240	480	600	250	500	220/240		380/415		690	
					I <sub>cu</sub>	I <sub>cs</sub>	I <sub>cu</sub>	I <sub>cs</sub>	I <sub>cu</sub>	I <sub>cs</sub>		
N	NPG	65	35	25	22	35	65	35	50	25	20	10
H	HPG	100	65	35	25	50	100	50	70	35	30	15
L	LPG	200	100	65	42	65	200	100	100	50	35	17

## Connectors for 75°C Wire

Construction	Ampere Rating	Wire Range	No. of cables per phase	Catalog Number
Aluminum	1200-1600A	1/0-750 kcmil Al/Cu	6	3TA6PG750 <sup>①③</sup>
Aluminum	1200-1600A	300-600 kcmil Al/Cu	5	TA5P600 <sup>②④</sup>
Aluminum	1200-1600A	600-750 kcmil Al/Cu	4	TA4P750 <sup>②④</sup>
Aluminum	1200-1600A	300-600 kcmil Al/Cu	6	TA6R600 <sup>②④</sup>
Copper	1200-1600A	300-600 kcmil Cu	5	TC5R600 <sup>②④⑤</sup>

## Mounting Arrangement

Description	Catalog Number
Lug Mounting Assembly	LMAP1600
Breaker Mounting Base (Front Connect)	MBPG1600
Breaker Mounting Base (Rear Connect)	MBPG1601

## PG 1600A Frame 3-Pole with Thermal-Magnetic Trip Unit<sup>®</sup>

Continuous Ampere Rating	N-Interrupting Class	H-Interrupting Class	L-Interrupting Class
	Catalog Number	Catalog Number	Catalog Number
	COMPLETE FACTORY ASSEMBLED CIRCUIT BREAKER		
1200	NPX3B120	HPX3B120	LPX3B120
1400	NPX3B140	HPX3B140	LPX3B140
1600	NPX3B160	HPX3B160	LPX3B160

① Requires Lug Mounting Assembly LMAP1600.  
 ② Requires Breaker Mounting Base MBPG1600 Kit or MBPG1601.  
 ③ Consists of 3 connectors.

④ Consists of 1 connector.  
 ⑤ Required for 100% rated PG breakers. Requires 90°C cable sized at 75°C ampacity.  
 ⑥ IEC 60947-2: ONLY applies to Electronic Trip Units (ETUs).

External Accessories pages 7-187 through 7-201

# VL Circuit Breakers

PG 1600A Electronic Trip Units

Selection

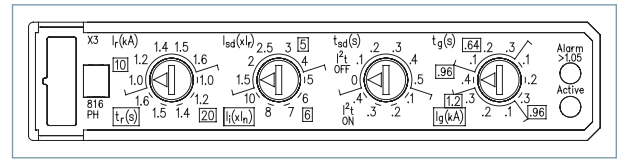
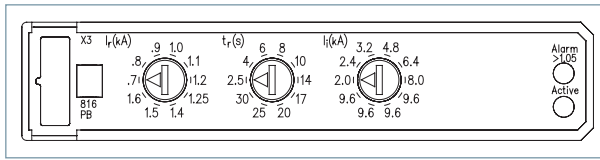

Model 555 Trip Unit

## PG 1600A Frame 3-Pole Electronic Trip Unit

Continuous Ampere Rating	N-Interrupting Class	H-Interrupting Class	L-Interrupting Class	Catalog Number
	Catalog Number	Catalog Number	Catalog Number	
	FRAME ONLY			
	NPG3F160	HPG3F160	LPG3F160	
COMPLETE FACTORY ASSEMBLED CIRCUIT BREAKER				TRIP UNIT ONLY
<b>ELECTRONIC LI TRIP</b>				
1200	NPG3R120	HPG3R120	LPG3R120	CPT3R120
1600	NPG3R160	HPG3R160	LPG3R160	CPT3R160
<b>ELECTRONIC LSI TRIP</b>				
1200	NPG3T120	HPG3T120	LPG3T120	CPT3T120
1600	NPG3T160	HPG3T160	LPG3T160	CPT3T160
<b>ELECTRONIC LSIG TRIP</b>				
1200	NPG3V120	HPG3V120	LPG3V120	CPT3V120
1600	NPG3V160	HPG3V160	LPG3V160	CPT3V160
<b>ELECTRONIC LIG TRIP</b>				
1200	NPG3W120	HPG3W120	LPG3W120	CPT3W120
1600	NPG3W160	HPG3W160	LPG3W160	CPT3W160

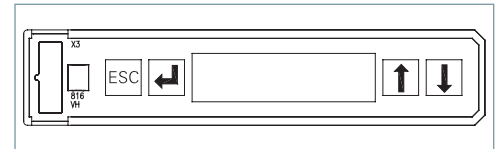

Model 586 Trip Unit

## PG 1600A Frame 3-Pole Electronic LCD Trip Unit

Continuous Ampere Rating	N-Interrupting Class	H-Interrupting Class	L-Interrupting Class	Catalog Number
	Catalog Number	Catalog Number	Catalog Number	
	FRAME ONLY			
	NPG3F160	HPG3F160	LPG3F160	
COMPLETE FACTORY ASSEMBLED CIRCUIT BREAKER				TRIP UNIT ONLY
<b>LCD ELECTRONIC LSI TRIP</b>				
1200	NPG3A120	HPG3A120	LPG3A120	CPT3A120
1600	NPG3A160	HPG3A160	LPG3A160	CPT3A160
<b>LCD ELECTRONIC LSIG TRIP</b>				
1200	NPG3G120	HPG3G120	LPG3G120	CPT3G120
1600	NPG3G160	HPG3G160	LPG3G160	CPT3G160
<b>LCD ELECTRONIC LSI TRIP + GF ALARM ONLY</b>				
1200	NPG3K120	HPG3K120	LPG3K120	CPT3K120
1600	NPG3K160	HPG3K160	LPG3K160	CPT3K160

7  
MOLDED CASE  
CIRCUIT BREAKERS

# VL Circuit Breakers

Internal Accessories for MG 800A, NG 1200A, and PG 1600A Frames

Selection

## Auxiliary Switch and Alarm Switch Combination Kits

Description	Mounting Pocket <sup>①</sup>	Catalog Number
2 Aux. + 2 Alarm Switches 2A + 2B Base AMBP2	Left Pocket Only	<b>ASKP3</b>
4 Aux. Switches 2A + 2B Base AMBP1	Left, Right	<b>ASKP4</b>

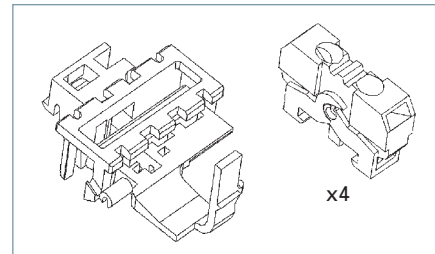

## Auxiliary/Alarm Switch Mounting Base Only

Description	Mounting Pocket <sup>①</sup>	Catalog Number
Up to 4 Auxiliary Switches 2 Aux. + 2 Alarm Switches	Left, Right Left Pocket Only	<b>AMBP1</b> <b>AMBP2</b>

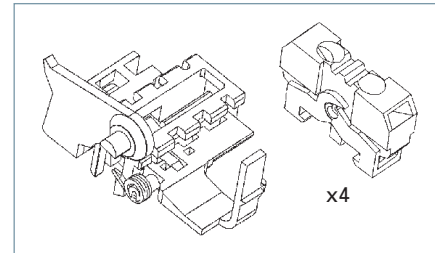

## Auxiliary/Alarm Switch Only

Common to DG-PG Frames

Description	Catalog Number
1 Normally Open Contact (1A)	<b>ASWPA</b>
1 Normally Closed Contact (1B)	<b>ASWPB</b>

## Shunt Trips

Description	Mounting Pocket	Catalog Number
24 VDC	Right Pocket Only	<b>STRPB24DC</b>
48-60 VDC		<b>STRPC60DC</b>
110-127 VDC		<b>STRPD125DC</b>
220-250 VDC		<b>STRPE250DC</b>
48-60 VAC		<b>STRPM60</b>
110-127 VAC		<b>STRPN120</b>
208-277 VAC		<b>STRPS277</b>
380-600 VAC		<b>STRPV600</b>



## Undervoltage Release

Description	Mounting Pocket	Catalog Number
12 VDC	Right Pocket Only	<b>UVRPA12DC</b>
24 VDC		<b>UVRPB24DC</b>
48 VDC		<b>UVRPC48DC</b>
60 VDC		<b>UVRPG60DC</b>
110-127 VDC		<b>UVRPD125DC</b>
220-250 VDC		<b>UVRPE250DC</b>
110-127 VAC		<b>UVRPN120</b>
220-240 VAC		<b>UVRPR240</b>
208 VAC		<b>UVRPP208</b>
277 VAC		<b>UVRPS277</b>
380-415 VAC		<b>UVRPT415</b>
440-480 VAC		<b>UVRPU480</b>

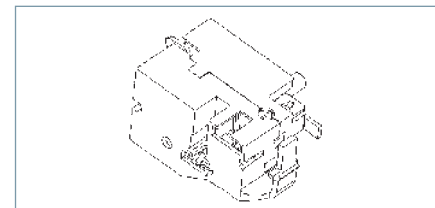

① Refer to the "Accessory Locations" chart on page 7-202 for guidelines and limitations about which pockets may be used for accessory combinations.

'A' refers to a normally open contact (open when the breaker contacts are open).

'B' refers to a normally closed contact (closed when the breaker contacts are open).

# VL Circuit Breakers

## Molded Case Switch

## Selection

### General

Typically a molded case switch is used when a compact load-break switch is needed for disconnect purposes. The VL line of molded case switches from Siemens is made of the same materials and components as the VL circuit breakers but do not provide overcurrent protection. Each molded case

switch has a fixed instantaneous self-protecting trip element which may open the switch under high fault conditions.

### Application Note

Overcurrent protection must be provided by an appropriate overcurrent protective device located upstream from

the molded case switch. Also, the short-circuit current rating of the switch is limited to the interrupting rating of the upstream protective device or the ratings in the table below, **whichever is less.**

### Ordering Information

Each type VL molded case switch accepts the same terminals and accessories as the equivalent VL circuit breakers.

All type VL molded case switches are suitable for reverse feed applications.

Mounting hardware and standard line and load terminals are included on ratings through 250A. For 400 – 1600A ratings, order the lugs separately.

All ratings are UL listed and CSA certified.

## Molded Case Switch

Maximum Ampere Rating / Frame	2-Pole	3-Pole	Short-Circuit Current Rating <sup>①</sup>			Self Protective Instantaneous Override
	Catalog Number	Catalog Number	240V	480V	600V	
150A / DG	<b>HDR2S150</b>	<b>HDR3S150</b>	100k	65k	20k	2,500A
250A / FG	<b>HFR2S250</b>	<b>HFR3S250</b>	100k	65k	20k	3,500A
400A / JG	<b>HJS2S400</b>	<b>HJS3S400</b>	100k	65k	25k	4,400A
600A / LG	<b>HLR2S600</b>	<b>HLR3S600</b>	100k	65k	18k	5,500A
800A / MG	<b>HMS2S800</b>	<b>HMS3S800</b>	100k	65k	35k	6,500A
1200A / NG	<b>HNS2S120</b>	<b>HNS3S120</b>	100k	65k	35k	12,000A
1600A / PG	—	<b>HPS3S160</b>	100k	65k	35k	14,000A

Maximum Ampere Rating / Frame	3-Pole	Short-Circuit Current Rating <sup>①</sup>			Self Protective Instantaneous Override
	Catalog Number	240V	480V	600V	
250A / FG	<b>LFR3S250</b>	200k	100k	25k	3,500A
400A / JG	<b>LJS3S400</b>	200k	100k	25k	4,400A
600A / LG	<b>LLR3S600</b>	200k	100k	18k	5,500A
800A / MG	<b>LMS3S800</b>	200k	100k	65k	6,500A
1200A / NG	<b>LNS3S120</b>	200k	100k	65k	12,000A
1600A / PG	<b>LPS3S160</b>	200k	100k	65k	14,000A

<sup>①</sup>The Short-Circuit Current Rating is the maximum available current of the circuit where the switch is used, when protected by an appropriate overcurrent protective device.



# VL Circuit Breakers

## General

### Protection of Motor Circuits

Molded case circuit breakers are used in motor circuits as a disconnecting means and for short-circuit protection. They should be used in conjunction with motor-running, over-current protection devices, and should permit the motor to start without nuisance tripping from motor-inrush current. The circuit breaker should have a continuous current rating of not less than 115% of the motor full-load current.

The recommended motor circuit protectors listed have continuous-current ratings of at least 115% of motor full-load currents. The trip setting positions are approximately 11 times motor full-load current. The suggested trip settings may need to be adjusted upward to no higher than 1300% of full-load current for non-design E type motors, and no greater than 1700% of full-load current for design E motors, to allow for motor startup due to in-rush current.

### Breaker Mounted Immediately Ahead of Motor Starter

Siemens motor circuit protectors are recommended for use in combination motor starters to provide selective short-circuit protection for the motor branch circuit. The adjustable instantaneous trip feature of the Siemens motor circuit protector provides for a trip setting slightly above the peak motor in-rush current. With this setting, no delay is introduced in opening the circuit when a fault occurs. This circuit breaker has no time-delay trip element. Therefore it must be used in conjunction with, and immediately ahead of, the motor-running overcurrent protection device.

Important: The information below does not apply to all motor applications: it is recommended that the user refer to the National Electrical Code (NEC) for specific needs.

**Table 1 (When Breaker is Mounted Immediately Ahead of Motor Starter)**

3-Phase Induction Type Motors (Siemens motor circuit protectors for branch circuit use with alternating-current combination, full voltage motor starters)

Motor Full Load Amperes	Trip Setting (A)	Catalog Number <sup>①</sup>
35-50	450	HDP3L150L
42-60	540	
48-70	630	
55-80	720	
62-90	810	
69-100	900	
58-83	750	HDP3M150L
69-100	900	
81-117	1050	
92-133	1200	
104-150	1350	
115-150 <sup>②</sup>	1500	
96-139	1250	HDP3H150L
115-150 <sup>②</sup>	1500	
135-150 <sup>②</sup>	1750	
135-150 <sup>②</sup>	2000	
135-150 <sup>②</sup>	2250	
135-150 <sup>②</sup>	2500	
46-67	600	HFP3L250L
55-80	720	
65-93	840	
74-107	960	
83-120	1080	
92-133	1200	
77-111	1000	HFP3M250L
92-133	1200	
108-156	1400	
123-178	1600	
138-200	1800	
154-222	2000	
135-194	1750	HFP3H250L
162-210	2100	
188-220	2450	
215-241	2800	
242-250 <sup>②</sup>	3150	
242-250 <sup>②</sup>	3500	

① Motor circuit protectors rated 150A and 250A are supplied with line and load lugs installed. If lugs are required on 400A to 1200A motor circuit breakers, order required lugs separately.

Motor Full Load Amperes	Trip Setting (A)	Catalog Number <sup>①</sup>
96-139	1250	HJM3L400
115-167	1500	
135-194	1750	
154-222	2000	
173-250	2250	
192-278	2500	
154-222	2000	HJM3M400
185-267	2400	
215-311	2800	
246-356	3200	
277-400	3600	
308-400 <sup>②</sup>	4000	
154-222	2000	HLM3J600
185-267	2400	
215-311	2800	
246-356	3200	
277-400	3600	
308-444	4000	
212-306	2750	HLM3Y600
254-367	3300	
296-428	3850	
338-489	4400	
381-550	4950	
423-600	5500	
250-361	3250	HMM3M800
292-422	3800	
335-483	4350	
385-556	5000	
442-638	5740	
500-722	6500	
385-556	5000	HNM3M120
462-667	6000	
538-778	7000	
615-889	8000	
692-1000	9000	
769-1111	10,000	

② These settings are provided for starting currents greater than 11X but not to exceed 17X. Full Load Amps (FLA) not to exceed ampere rating of MCP.

7  
MOLDED CASE  
CIRCUIT BREAKERS

# VL Circuit Breakers

## 600 Volt DC Circuit Breakers

Selection

### General

Siemens UL Listed non-interchangeable trip DC Thermal/magnetic Molded Case Circuit Breakers shown below are for use in grounded & ungrounded general DC circuits and ungrounded battery supply circuits of UPS systems. These breakers are rated at 600Vdc closed circuit and feature rated interruption levels from 42,000 to 65,000 amperes as indicated in

the table. This family of circuit breakers is rated from 100 to 1600 Amperes.

Types HFGD through HPGD circuit breakers are provided with an adjustable magnetic over-current function located on the face of the circuit breaker. Contact Siemens for specific magnetic over-current values.

To properly use these UL Listed circuit breakers at 600Vdc and the indicated

interruption level, it is necessary to connect the terminals of the 3 pole circuit breaker in a series configuration as shown in the diagram below.

Types HFGD through HPGD use the same internal and external accessories as the standard FG through PG frames and associated types. Consult the individual frame section for accessory information.

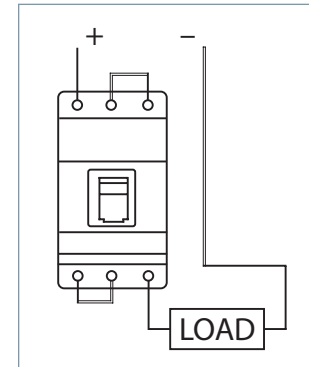

Frame	Type	Continuous Ampere Rating	Catalog Number (3-pole) <sup>①</sup>	Short-Circuit Current Rating 600VDC <sup>②</sup>
FG	HFGD	100	HFC3B100	42K
		150	HFC3B150	42K
		175	HFC3B175	42K
		200	HFC3B200	42K
		250	HFC3B250	42K
JG	HJGD	250	HJC3B250	65K
		300	HJC3B300	65K
		350	HJC3B350	65K
		400	HJC3B400	65K
LG	HLGD	400	HLC3B400	65K
		500	HLC3B500	65K
		600	HLC3B600	65K
MG	HMGD	600	HMC3B600	65K
		700	HMC3B700	65K
		800	HMC3B800	65K
NG	HNGD	800	HNC3B800	65K
		900	HNC3B900	65K
		1000	HNC3B1000	65K
		1200	HNC3B1200	65K
PG	HPCGD	1200	HPC3B1200	65K
		1400	HPC3B1400	65K
		1600	HPC3B1600	65K

<sup>①</sup> Terminal connectors must be ordered separately; see page 7-196.

<sup>②</sup> Standard VL breakers DG - PG feature DC ratings up to 500V for ungrounded UPS applications. Consult the individual frame section for more information.

## Modularity To Support All Your Application Needs Modules and More: VL Circuit Breakers with Optional Accessories

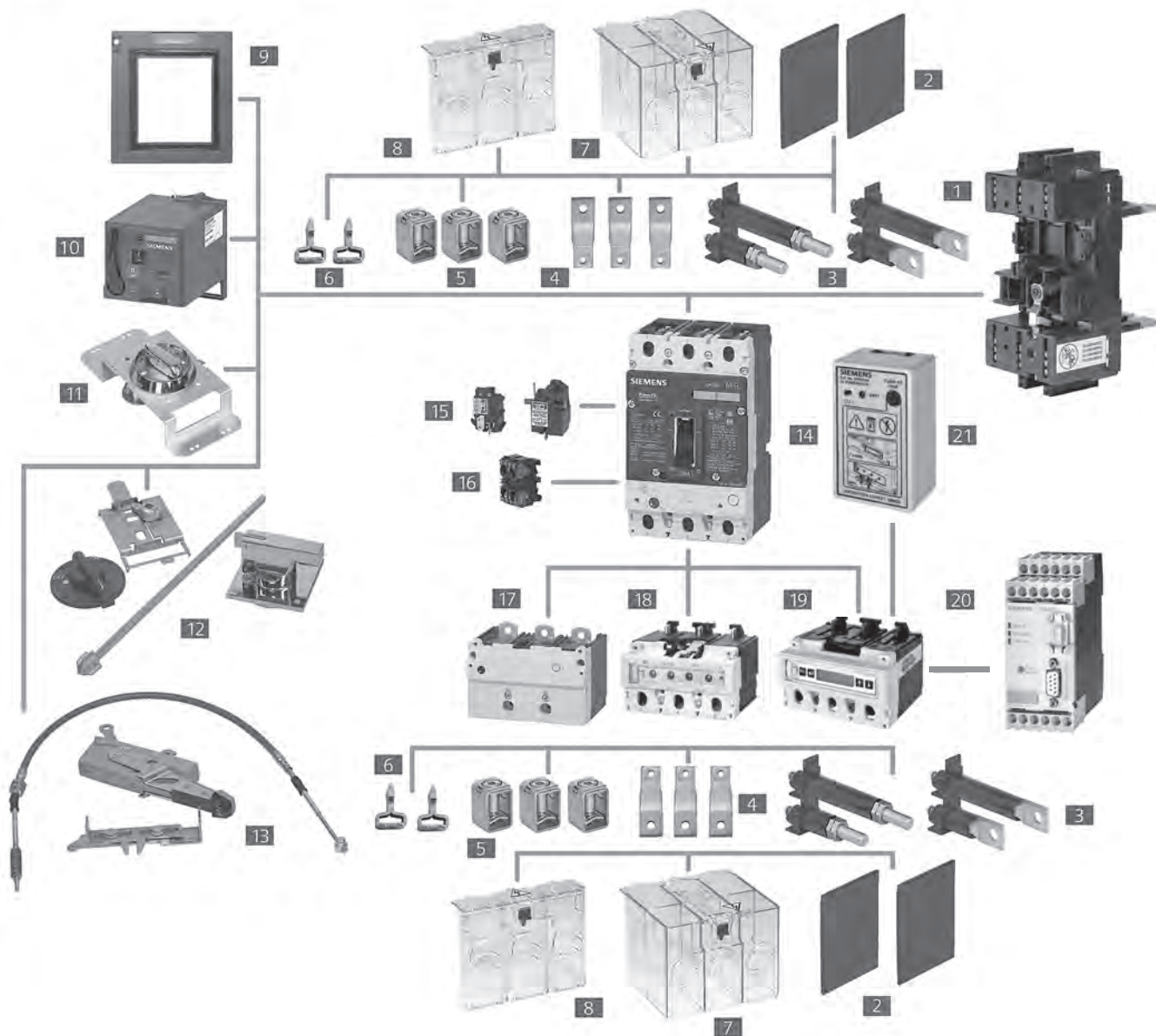

- |  |   |  |
|--|---|--|
| <b>1</b> Base for Plug-In or Draw-Out    | <b>9</b> Cover Frame for Door Cutout          | <b>17</b> Thermal Magnetic Trip Unit (525)                 |
| <b>2</b> Interphase Barriers             | <b>10</b> Stored Energy Operator              | <b>18</b> Electronic Trip Unit (555)                       |
| <b>3</b> Rear Terminals – Flat and Round | <b>11</b> Rotary Handle Operator              | <b>19</b> Elec. Trip Unit with LCD (586)                   |
| <b>4</b> Bus Extensions                  | <b>12</b> Variable Depth Rotary Operator      | <b>20</b> Communication Module with ZSI                    |
| <b>5</b> Terminal Connectors             | <b>13</b> Max Flex Operator                   | <b>21</b> Electronic Trip Unit Tester and LCD Power Supply |
| <b>6</b> Plug-In Terminal Blades         | <b>14</b> Circuit Breaker                     |  |
| <b>7</b> Extended Terminal Shield        | <b>15</b> Shunt Trip or Undervoltage Releases |  |
| <b>8</b> Standard Terminal Shield        | <b>16</b> Auxiliary/Alarm Switches            |  |

# External Accessories

## Operating Mechanisms

RHFF



RHVF12



RHVFBM



RHVM3RH



RHVMS12



RHVM12H



For DG to FG Frame  
150 to 250 A

For JG to LG Frame  
400 A to 600 A

**Description**

**Catalog Number**

**Catalog Number**

**Through-Door Rotary Handle Operator Kit**

Fixed depth and the handle is mounted directly on the circuit breaker. Lockable knob (for up to 3 padlocks). NEMA 1, 12

RHFF

RHFL

Red Handle Version with red knob, yellow indicator plate NEMA 1, 12

RHFFEM

RHFLEM

**Door-Mounted Rotary Handle Operator Kit**

Variable depth, door mounted handle. Includes knob with masking frame, indicator plate, detachable door coupling, 12" shaft, and breaker mounted rotary operator. Lockable knob (for up to 3 padlocks). NEMA 1, 12

RHVF12

RHVL12

**Auxiliary Switch Kits**

For Direct or Extended Rotary Handle Operators (RHF and RHV). Form C, Early Break type2 Aux. Switch Kit<sup>Ⓞ</sup>

Includes 1 switch with 5' wire For Door-Mounted Operator For Through-Door Operator

—  
RHSFA1F

RHSLA1  
RHSLA1F

Includes 2 switches with 5' wire For Door-Mounted Operator For Through-Door Operator

—  
RHSFA2F

RHSLA2  
RHSLA2F

**Door-Mounted Rotary Operator Mechanism**

Breaker mechanism only

RHVFBM

RHVLBM

**Door-Mounted Rotary Handle Only**

Standard version NEMA 1, 12 NEMA 3R NEMA 4X

RHVM12H  
RHVM3RH  
RHVM4XH  
RHVMEMH

RHVM12H  
RHVM3RH  
RHVM4XH  
RHVMEMH

Red Handle version

**NFPA-79 Handle Kit**

Intermediate handle for NFPA-79 compliance with door-mounted rotary operator

RHVF79H

RHVM79H

**Extension Shaft Only, for Door Mounted Operator**

2 inches (50.8mm)  
3 inches (76.2mm)  
12 inches (304.8 mm)  
16 inches (406.4 mm)  
24 inches (609.6mm) w/ support bracket

RHVMS02  
—  
RHVMS12  
RHVMS16  
RHVMS24

RHVMS02  
—  
RHVMS12  
RHVMS16  
RHVMS24

<sup>Ⓞ</sup> During manual operation, Early Break auxiliary switch contacts open before the breaker opens.

Description	For MG Frame 800 A	For NG to PG Frame 1200 to 1600 A	
	Catalog Number	Catalog Number	
<b>Through-Door Rotary Handle Operator Kit</b> Fixed depth, breaker mounted. For direct fitting to the circuit breaker. Lockable with up to 3 padlocks. NEMA 1, 12	—	—	—
Red Handle version with red knob, yellow indicator plate NEMA 1, 12	—	—	—
<b>Door-Mounted Rotary Handle Operator Kit</b> Variable depth, door mounted handle. Includes knob with masking frame, indicator plate, detachable door coupling, 12" shaft, and breaker mounted rotary operator. Lockable knob (for up to 3 padlocks). NEMA 1, 12	<b>RHVM12</b>	—	—
<b>Auxiliary Switch Kits</b> For Direct or Extended Rotary Handle Operators (RHF and RHV). Early Break type2 Aux. Switch Kit Includes 1 switch with 5' wire For Door-Mounted Operator For Through-Door Operator	<b>RHSMA1</b> —	<b>RHSPA1</b> —	—
Includes 2 switches with 5' wire For Door-Mounted Operator For Through-Door Operator	<b>RHSMA2</b> —	<b>RHSPA2</b> —	—
<b>Door-Mounted Rotary Operator Mechanism</b> Breaker mechanism only	<b>RHVMBM</b>	<b>RHVPBM</b>	
<b>Door-Mounted Rotary Handle Only</b> Standard version NEMA 1, 12 NEMA 3R NEMA 4X Red Handle version	<b>RHVM12H</b> <b>RHVM3RH</b> <b>RHVM4XH</b> <b>RHVMEMH</b>	<b>RHVP3RH</b> <b>RHVP3RH</b> <b>RHVP4XH</b> <b>RHVPEMH</b>	
<b>NFPA-79 Handle Kit</b> Intermediate handle for NFPA-79 compliance with door-mounted rotary operator	<b>RHVM79H</b>	<b>RHVP79H</b>	
<b>Extension Shaft Only, for Door Mounted Operator</b> 2 inches (50.8mm) 3 inches (76.2mm) 12 inches (304.8 mm) 16 inches (406.4 mm) 24 inches (609.6mm) w/ support bracket	<b>RHVMS02</b> — <b>RHVMS12</b> <b>RHVMS16</b> <b>RHVMS24</b>	— <b>RHVPS03</b> <b>RHVPS12</b> — <b>RHVPS24</b>	— — — —

# External Accessories

## Operating Mechanisms

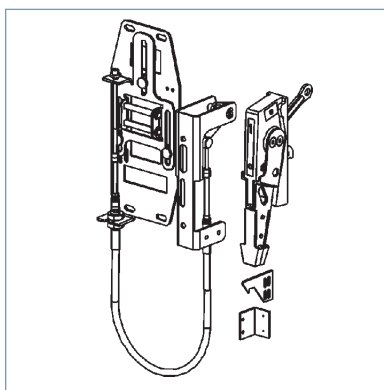
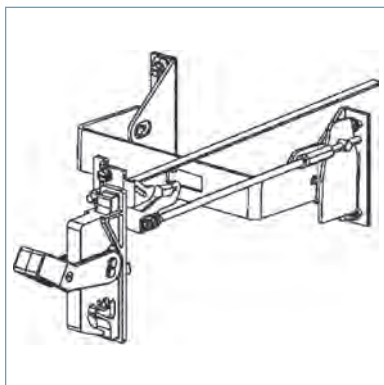

Description	For DG and FG Frame 150 to 250 A	For JG and LG Frame 400 to 600 A
	Catalog Number	Catalog Number
<b>Variable Depth Flange Mounted Operator Kit</b> Adjustable from 8" to 16" Complete kit, includes handle and variable depth operator. NEMA 1, 3R, 12 NEMA 4X IEC Black Handle NEMA 1, 3R, 12 NEMA 4X	FHVF3R FHVF4X FHVF3RB FHVF4XB	FHVL3R FHVL4X FHVL3RB FHVL4XB
<b>Max-Flex™, Variable Depth Flange Mounted Operator Kit</b> Complete kit, includes plastic handle, breaker operator, and cable. NEMA 1, 3R, 12 For DG and FG operators, the cable is 36", all others are 48" May be right- or left-hand mounted	MFKF3R	MFKL3R
<b>Handle Only, for Max-Flex™ Variable Depth</b> NEMA 1, 3R, 12 Plastic NEMA 1, 3R, 12 Steel - epoxy coated NEMA 4, 4X Steel - chrome plated Solid color (all gray) Plastic <sup>①</sup> NEMA 1, 3R, 12 Solid color (black handle) Steel epoxy coated <sup>①</sup> NEMA 1, 3R, 12	MFHM3R MFHM3RS MFHM4X MFHM3RB MFHM3RSB	MFHM3R MFHM3RS MFHM4X MFHM3RB MFHM3RSB
<b>Breaker Operator Mechanism Only, for Max-Flex™</b>	MFMF	MFML
<b>Cable Only, for Max-Flex™ Variable Depth</b> 36" 48" 60" 72" 84" 96" 120" 144"	MFCF036 MFCF048 MFCF060 MFCF072 MFCF084 MFCF096 MFCF120 MFCF144	MFCM036 MFCM048 MFCM060 MFCM072 MFCM084 MFCM096 MFCM120 MFCM144
<b>Handle Auxiliary Switch</b> Form C (1NO - 1NC), early break <sup>②</sup> 1 Aux. switch 2 Aux. switch	MFSFA1 MFSFA2	MFSLA1 MFSLA2

① Max-Flex™ handles are available with solid gray or black handles instead of the customary "Red for On" flange handle.

The black handle is preferred for IEC markets, where red handles have a specific meaning.

② During manual operation, Early Break aux. contacts open before the breaker opens.

Description	For MG Frame 800 A	For NG Frame 1200 A	For PG Frame 1600 A
	Catalog Number	Catalog Number	Catalog Number
<b>Variable Depth Flange Mounted Operator Kit</b> Adjustable from 8" to 16" Complete kit, includes handle and variable depth operator.			
NEMA 1, 3R, 12	—	—	
NEMA 4X	—	—	
IEC Black Handle NEMA 1, 3R, 12	—	—	
NEMA 4X	—	—	
<b>Max-Flex™, Variable Depth Flange Mounted Operator Kit</b> Complete kit, includes plastic handle, breaker operator, and cable. NEMA 1, 3R, 12 For DG and FG operators, the cable is 36", all others are 48" May be right- or left-hand mounted	<b>MFKM3R</b>	<b>MFKP3RS</b>	<b>MFKP3RS</b>
<b>Handle Only, for Max-Flex™ Variable Depth</b>			
NEMA 1, 3R, 12 Plastic	<b>MFHM3R</b>	—	—
NEMA 1, 3R, 12 Steel - epoxy coated	<b>MFHM3RS</b>	<b>MFHP3RS</b>	<b>MFHP3RS</b>
NEMA 4, 4X Steel - chrome plated	<b>MFHM4X</b>	<b>MFHP4X</b>	<b>MFHP4X</b>
Solid color (all gray) Plastic <sup>①</sup>			
NEMA 1, 3R, 12	<b>MFHM3RB</b>	—	—
Solid color (black handle) Steel epoxy coated <sup>①</sup>			
NEMA 1, 3R, 12	<b>MFHM3RSB</b>	<b>MFHP3RSB</b>	<b>MFHP3RSB</b>
<b>Breaker Operator Mechanism Only, for Max-Flex™</b>	<b>MFMM</b>	<b>MFMP</b>	<b>MFMP</b>
<b>Cable Only, for Max-Flex™ Variable Depth</b>			
36"	<b>MFCM036</b>	—	—
48"	<b>MFCM048</b>	<b>MFCP048</b>	<b>MFCP048</b>
60"	<b>MFCM060</b>	<b>MFCP060</b>	<b>MFCP060</b>
72"	<b>MFCM072</b>	<b>MFCP072</b>	<b>MFCP072</b>
84"	<b>MFCM084</b>	—	—
96"	<b>MFCM096</b>	<b>MFCP096</b>	<b>MFCP096</b>
120"	<b>MFCM120</b>	<b>MFCP120</b>	<b>MFCP120</b>
144"	<b>MFCM144</b>	<b>MFCP144</b>	<b>MFCP144</b>
<b>Handle Auxiliary Switch</b> Form C (1NO - 1NC), early break <sup>②</sup> 1 Aux. switch 2 Aux. switch	<b>MFSPA1</b> <b>MFSPA2</b>	<b>MFSPA1</b> <b>MFSPA2</b>	<b>MFSPA1</b> <b>MFSPA2</b>

① Max-Flex™ handles are available with solid gray or black handles instead of the customary "Red for On" flange handle.

The black handle is preferred for IEC markets, where red handles have a specific meaning.

② During manual operation, Early Break aux. contacts open before the breaker opens.

# External Accessories

## Operating Mechanisms

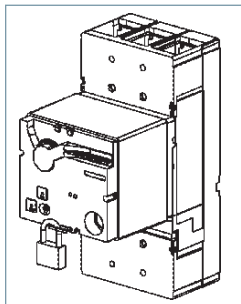

Description	For DG to FG Frame 150 to 250 A	
	Catalog Number	
<b>Stored Energy and Motor Operators</b> Lockable with up to 3 padlocks.		
AC Voltage   DC Voltage	Stored Energy Type	
—   24	SEAFB	
42-48   42-48	SEAFM	
60   60	SEAFY	
110-127   110-127	SEAFN	
220-250   220-250	SEAFR	
<b>Cylinder Locks for Field Installation</b>	CLKF	

## Plug-In and Draw-Out Bases



Description	For DG Frame 150 A	For FG Frame 250 A
	Catalog Number	Catalog Number
<b>Plug-in Mounting Base Assembly</b> Includes base, terminal blade kit, sec. terminal block assembly, base trip interlock, and mounting hardware.		
<b>Rear Connected</b> 3-pole	PCBDR3	PCBFR3
<b>Front Connected</b> 3-pole	PCBDF3	PCBFF3
<b>Draw-out Assembly</b> Includes base, position indicator switch, socket, base trip interlock, crank handle, connectors, and necessary shields.		
<b>Rear Connected</b> 3-pole	DCADR3	DCAFR3
<b>Front Connected</b> 3-pole (Draw-out assembly includes side plates and all hardware)	DCADFC3	DCAFFC3
<b>Hex Wrench</b> for racking draw-out assembly and position indicator	DCHP	DCHP
<b>Position Indicator Switch</b> Form "C" switch to indicate breaker engaged/de-engaged position. <sup>①</sup>	DCIP	DCIP
<b>Secondary Terminal Block Assy.</b> Accessory connections for plug-in or draw-out breakers. Pre-wired plug and block with 8 terminal points. <sup>②</sup>	PCTF83	PCTF83
<b>Plug-In Spare Breaker Kit</b> Set of 6 terminal blades, 2 terminal shield, & 1 trip interlock	PCXD3	PCXF3
<b>Draw-out Spare Breaker Kit</b> Set of 6 terminal blades, & 1 trip interlock	DCXD3	DCXF3
<b>Spare Breaker Trip Interlock</b>	PCXFT	PCXFT

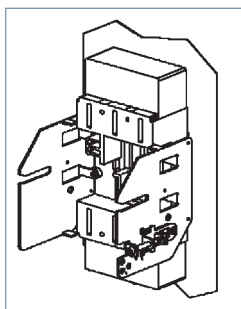
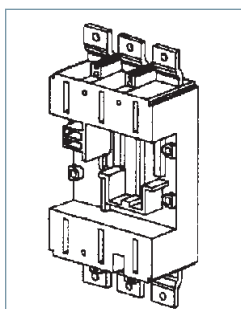

7  
MOLDED CASE  
CIRCUIT BREAKERS

① Up to 2 position indicator switches may be mounted per plug-in or draw-out base.

② Up to 2 plugs per breaker (16 terminal points) may be mounted on DG, and FG breakers. Up to 3 plugs per breaker (24 terminal points) may be mounted on JG, LG, MG, NG, and PG breakers.



For JG to LG Frame  
400 to 600 A

For MG Frame  
800 A

For NG to PG Frame  
1200 to 1600 A

Catalog Number

Catalog Number

Catalog Number

Stored Energy Type

SEALB  
SEALM  
SEALY  
SEALN  
SEALR  
CLKP

Stored Energy Type

SEAMB  
SEAMM  
SEAMY  
SEAMN  
SEAMR  
CLKP

Motor Operator Type

MTRPB  
MTRPM  
MTRPY  
MTRPN  
MTRPR  
CLKP

For JG Frame  
400 A

For LG Frame  
600 A

For MG Frame  
800 A

For NG Frame  
1200 A

For PG Frame  
1600 A

Catalog Number

Catalog Number

Catalog Number

Catalog Number

Catalog Number

PCBJRC3  
PCBJFC3

PCBLRC3  
PCBLFC3

PCBMRC3  
—

PCBNRC3  
—

—  
—

DCAJRC3  
DCAJFC3

DCALRC3  
DCALFC3

—  
—

—  
—

—  
—

DCHP

DCHP

—

—

—

DCIP

DCIP

—

—

—

PCTL83

PCTL83

—

—

—

PCXJ3

PCXL3

—

—

—

DCXJ3

DCXL3

—

—

—

PCXLT

PCXLT

—

—

—

# External Accessories

## Connections

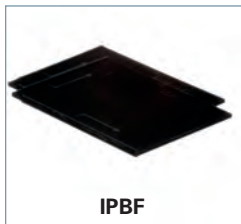
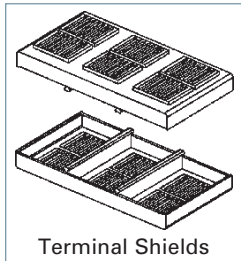
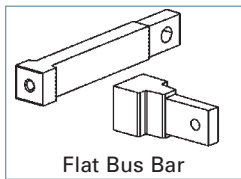
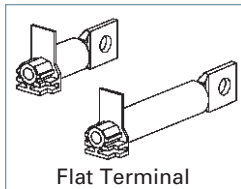
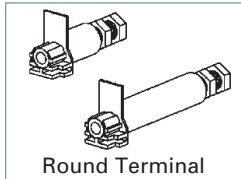
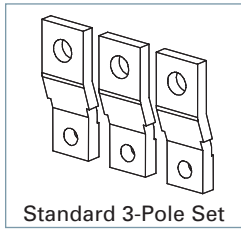

Description	For DG Frame 150 A	For FG Frame 250 A
	Catalog Number	Catalog Number
<b>Front Bus Bar Connections</b> Includes nut keeper plates and shield. Standard (straight) 3-Pole Set Bus Bar Connection Strap Kit Includes 6 - Bus Bars, 6 Nut Keepers & Shields 100% rated applications	FBCE3 — —	FBCE3 — —
<b>Rear-Connecting Studs</b> Short length round term. (1piece) Long length round term. (1piece) 3-Pole round term. kit, 2 short + 1 long Short length flat term. (1piece) Long length flat term. (1piece) 3-Pole flat term. kit, 2 short + 1 long Flat bus bar type (1 piece) 3-Pole set of flat bus bar	RTLDSR RTLDLR SRTDR3 RTLDSF RTLDLF SRTDF3 — —	RTLFSR RTLFLR SRTFR3 RTLFSF RTLFLF SRTFF3 — —
<b>Terminal Shields</b> Includes 2 terminal shields. 3-Pole Standard Shield 3-Pole Extended Shield	TSSF3 TSLF3	TSSF3 TSLF3
<b>Interphase Barriers</b> Set of 2 barriers Also fits plug-in and draw-out bases.	IPBF	IPBF
<b>Lug Mounting Assy.</b>	—	—
<b>Breaker Mounting Base</b> Front connected Rear connected	— —	— —

7  
MOLDED CASE  
CIRCUIT BREAKERS

For JG Frame 400 A	For LG Frame 600 A	For MG Frame 800 A	For NG Frame 1200 A	For PG Frame 1600 A
Catalog Number	Catalog Number	Catalog Number	Catalog Number	Catalog Number
FBCJ3 —	FBCL3 —	FBCM3 —	SSBP SSBPH	SSBP SSBPH
RTLJSR RTLJLR SRTJR3 RTLJSF RTLJLF SRTJF3 — —	— — — — — — RTLLSF SRTL3F3	— — — — — — RTLMSF SRTMF3	— — — — — — RTLNSF SRTNF3	— — — — — — — —
TSSL3 TSLL3	— —	TSSM3 TSLM3	TSSP3 TSLP3	TSSP3 TSLP3
IPBM	IPBM	IPBM	IPBP	IPBP
—	—	—	—	LMAP1600 <sup>®</sup>
— —	— —	— —	— —	MBPG1600 MBPG1601

① Not for use with standard AI terminals. Use Standard Shield for rear connection and Extended Shield for bus-bar connection.

② Kit includes connection for one side of breaker only. Order quantity 2 if connecting line and load side.

# External Accessories

## Connections

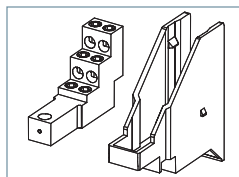
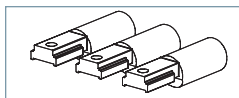
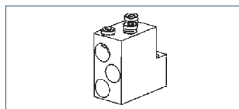
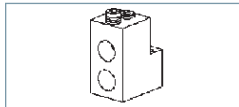
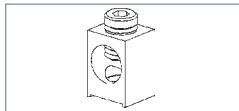
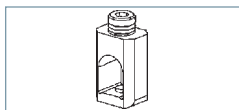
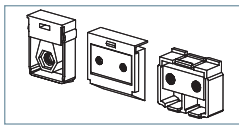

Note: pictures provide graphical representations only.

Description	For DG Frame 150 A	For FG Frame 250 A
	Catalog Number	Catalog Number
<b>Nut Keeper Plates</b> For ring/tongue terminal or bus bar connections. (For metric threads on other than the JG frame, change "TNK" to "TMK") 1 Nut Keeper Plate Kit of 3	<b>TNKD</b> <b>TNKD3</b>	<b>TNKF</b> <b>TNKF3</b>
<b>Mechanical Lugs</b> <i>Steel Wrap Around Body (Cu Wire Only)</i> Cable Size; (cables per phase) Single Lug Kit of 3	#8-1/0; 1-hole <b>TW1DG20</b> <b>3TW1DG20</b>	#4-350 kcmil; 1-hole <b>TW1FG350</b> <b>3TW1FG350</b>
<i>Aluminum Body (Al or Cu Wire)</i> Cable Size; (cables per phase) Single Lug Kit of 2  Kit of 3  Cable Size; (cables per phase)  Single Lug Kit of 2 Kit of 3  Cable Size; (cables per phase) Single Lug	#6-3/0; 1-hole <b>TA1DG30</b> —  <b>3TA1DG30</b>  — — — — —	#4-350 kcmil; 1-hole <b>TAW1FG350</b> —  <b>3TAW1FG350</b>  — — — — —
<i>Copper Body (Cu Wire Only)</i> Cable Size; (cables per phase) Single Lug Kit of 2  Kit of 3  Cable Size; (cables per phase) Single Lug	#6-3/0; 1-hole <b>TC1DG30</b> <sup>Ⓞ</sup> —  <b>3TC1DG30</b> <sup>Ⓞ</sup>  — —	#4-350 kcmil; 1-hole <b>TCW1FG350</b> <sup>Ⓞ</sup> —  <b>3TCW1FG350</b> <sup>Ⓞ</sup>  — —
<b>Compression Lugs</b> Cable Size; (cables per phase) Kit of 2 Kit of 3  Cable Size; (cables per phase) Kit of 2 Kit of 3  Cable Size; (cables per phase) Kit of 3	#14-2/0; 1-cable <b>2CLD20</b> <b>3CLD20</b>  — — —	#4-350 kcmil; 1-cable — <b>3CLF350</b>  — — —
<b>Distribution Lugs (Cu Wire Only)</b> Cable Size; (cables per phase) Single Lug Kit of 3 Cable Size; (cables per phase) Single Lug Kit of 3	#14-#2; 3-hole <b>TA3DG02</b> <b>3TA3DG02</b> #14-#4; 6-hole <b>TA6DG04</b> <b>3TA6DG04</b>	#14-#1; 2-hole and #14-2/0; 1-hole <b>TA3FG20</b> <b>3TA3FG20</b> #14-#4; 6-hole <b>TA6FG04</b> <b>3TA6FG04</b>
<b>Control Wire Terminals</b> Control Wire Terminal (Single) Control Wire Terminal (Kit of 3)	— —	— —

Ⓞ Required for 100% rated breakers. Requires 90°C cable sized at 75°C ampacity.

For JG Frame 400 A	For LG Frame 600 A	For MG Frame 800 A	For NG Frame 1200 A	For PG Frame 1600 A
Catalog Number	Catalog Number	Catalog Number	Catalog Number	Catalog Number
<b>TMKJ</b> <b>TMKJ3</b> <i>metric only</i>	<b>TNKL</b> <b>TNKL3</b>	<b>TNKM</b> <b>TNKM3</b>	<b>TNKP</b> <b>TNKP3</b>	<b>TNKP</b> <b>TNKP3</b>
1/0-600 kcmil; 1-hole <b>TW1JG600</b> <b>3TW1JG600</b>	— — —	— — —	— — —	— — —
3/0-250 kcmil; 2-hole <b>TA2JG250</b> — <b>3TA2JG250</b>  AL: 250-750 kcmil CU: 3/0-600 kcmil; 1-hole <b>TA1JG750</b> — <b>3TA1JG750</b> — — —	#2-600 kcmil; 2-hole — — <b>3TA2LG600LD</b> <sup>①</sup> <b>3TA2LG600LN</b> <sup>②</sup>  AL: 250-750 kcmil CU: 3/0-600 kcmil; 1-hole <b>TA1JG750</b> (400A max) <b>3TA1JG750</b> (400A max) — — —	1/0-500 kcmil; 3-hole <b>TA3MG500</b> <b>3TA3MG500</b>  500 -750 kcmil; 2-hole <b>TA2MG750</b> — <b>3TA2MG750</b>  #2-600 kcmil; 3-hole — <b>3TA3MG600</b> <sup>③</sup> (Kit of 3)	1/0-500 kcmil; 4-hole — <b>2TA4NG500</b>  <b>3TA4NG500</b> <b>3TA4NG500H</b> <sup>④</sup>  500 -750 kcmil; 3-hole <b>2TA3NG750</b> <b>3TA3NG750</b> —	1/0-750 kcmil; 6-hole — <b>3TA6PG750</b> <sup>⑤</sup>  600-750 kcmil; 4-hole <b>TA4P750</b> <sup>⑥</sup> — 300-600 kcmil; 5; 6-hole <b>TA5P600</b> <sup>⑥</sup> <b>TA6R600</b> <sup>⑥</sup> —
3/0-250 kcmil; 2-hole <b>TC2JG250</b> <sup>③</sup> — —  3/0-750 kcmil; 1-hole <b>TC1JG750</b> <sup>③</sup>	#2-600 kcmil; 2-hole — — <b>3TC2LG600LD</b> <sup>①③</sup> <b>3TC2LG600LN</b> <sup>②③</sup> — —	1/0-500 kcmil; 3-hole <b>TC3MG500</b> <sup>③</sup> — — — —	1/0-500 kcmil; 4-hole — — <b>3TC4NG500</b> <sup>③</sup>  — —	— — —  300-600 kcmil; 5-hole <b>TC5R600</b> <sup>③④</sup>
#6-350 kcmil; 1-cable — <b>3CLJ350</b>  250-600 kcmil; 1-cable <b>3CLJ600</b> — —	#6-350 kcmil; 2-cable <b>6CLL350</b> (kit of 6)  250-750 kcmil; 1-cable <b>3CLL750</b> — 250-600 kcmil; 2-cable <b>6CLL600</b> (kit of 6) —	— — — — — —	1/0-500 kcmil; 4-cable — <b>12CLN500</b> (kit of 12)  — — — — —	— — — — — —
#14-#4; 12-hole <b>TA12JG04</b> <b>3TA12JG04</b> #14-2/0; 6-hole <b>TA6JG20</b> <b>3TA6JG20</b>	— — — — —	— — — — —	— — — — —	— — — — —
<b>TA2JG250PT</b> —	— <b>3TA2LG600LNPT</b>	<b>TA3MG500PT</b> —	— <b>3TA4NG500PT</b>	— —

**7**  
 MOLDED CASE  
 CIRCUIT BREAKERS

All lug kits include the nut keepers.  
 ① Mounted on Load Side Only.  
 ② Mounted on Line Side Only.

③ Required for 100% rated breakers. Requires 90°C cable sized at 75°C ampacity.  
 ④ Requires extended modified shield.

⑤ Used only with LMAP1600 mounting base.  
 ⑥ Used only with MBPG1600 or MBPG1601 mounting base.

# External Accessories

## General

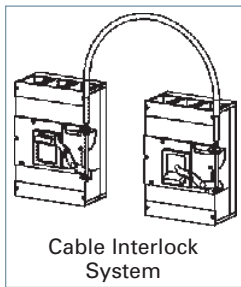
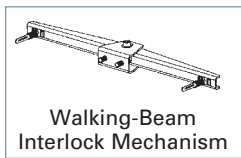
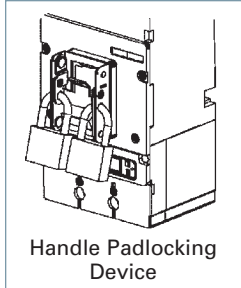

Description	For DG Frame 150 A	For FG Frame 250 A
	Catalog Number	Catalog Number
<b>Handle Padlocking Device</b> To padlock breaker toggle in the "OFF" position. Accepts up to 3 padlocks with 5–8 mm shackles.	HPLF	HPLF
<b>Handle Blocking Device</b> For holding the handle in the "ON" position. Not a lockout/tagout device.	HBDF	HBDF
<b>Walking-Beam Interlock Mechanism</b> Provides mechanical interlocking between two adjacent circuit breakers. Fixed mounted breakers	WBMFFM	WBMFFM
Note: Both breakers must be of the same frame size.		
<b>Cable Interlock Mechanism</b> Provides mechanical interlocking between 2 circuit-breakers - includes operator mechanism for one circuit breaker only. Combination with the next larger or smaller frame size is possible.	CBTF	CBTF
<b>Interlock Cable</b> Cable only, to connect 2 circuit breakers. Cable length 18 in. .46m (recommended up to 250A) Cable length 36 in. .91m (recommended from 400–800A) Cable length 54 in. 1.37m (recommended from 1200–1600A)	CBCF18 CBCM36 CBCP54	CBCF18 CBCM36 CBCP54
<b>Mounting Screw Kit</b> Includes the necessary hardware to mount a circuit breaker to the user's prepared surface Kit with 2 screws (SAE thread) Kit with 4 screws (SAE thread)	MSKF2 MSKF4	MSKF2 MSKF4
<b>Trip Adjustment Sealing Cover</b> Includes a trip unit cover to prevent tampering or adjustment of trip settings. Seal not included. Thermal-Magnetic Trip Units	3VL97008BL00 TSCFTM	3VL97008BL00 TSCFTM

7

MOLDED CASE  
CIRCUIT BREAKERS

For JG Frame 400 A	For LG Frame 600 A	For MG Frame 800 A	For NG Frame 1200 A	For PG Frame 1600 A
Catalog Number	Catalog Number	Catalog Number	Catalog Number	Catalog Number
HPLL	HPLL	HPLM	HPLP	HPLP
HBDL	HBDL	HBDM	HBDP	HBDP
WBMLFM	WBMLFM	WBMMFM	WBMPFM	WBMPFM
CBTL	CBTL	CBTM	CBTP	CBTP
— CBCM36 CBCP54	— CBCM36 CBCP54	— CBCM36 CBCP54	— — CBCP54	— — CBCP54
— MSKL4	— MSKL4	— MSKM4	— MSKP4	— MSKP4
3VL97008BL00 TSLTLM	3VL97008BL00 TSLTLM	3VL97008BL00 TSCMTM	3VL97008BL00 —	3VL97008BL00 —

# External Accessories

## Ground Sensors & Electronic Accessories

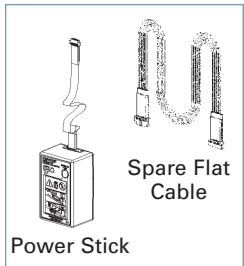

Description	For DG Frame 150 A	For FG Frame 250 A
	Catalog Number	Catalog Number
<b>Neutral Current Transformer (Ground Sensor, N-pole)</b>		
Neutral = 35/60A	NGSD060	—
Neutral = 100A	NGSF100	NGSF100
Neutral = 150A	NGSF150	NGSF150
Neutral = 250A	—	NGSJ250
Neutral = 400A	—	—
Neutral = 600A	—	—
Neutral = 800A	—	—
Neutral = 1000/1200A	—	—
Neutral = 1600A	—	—
<b>Communications &amp; Electronics</b>		
Power Stick - Hand held, battery operated power supply for LCD trip units. (Requires two 9V batteries.) Trip testing for both 555 & 586 trip units.	EPSP18V	EPSP18V
Spare flat cable for Power Stick.	COMPCA	COMPCA
COM20 Profibus Communications Module with ZSI for electronic trip units (order cable separately)	COMPRO20	COMPRO20
COM21 Modbus Communications Module with ZSI for electronic trip units (order cable separately)	COMM0D21	COMM0D21
Cable for COM20/21, 1.5 m (4.9 ft)	COMKIT3	COMKIT3
Cable for COM20/21, 3.0 m (9.8 ft)	COMKIT6	COMKIT6
Addressing Plug - assigns a field bus address without a PC by plugging into COM20/21	3UF79100AA000	3UF79100AA000

## Door Cutouts & Extensions

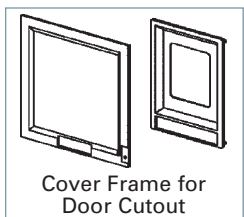

<b>Cover Frame for Door Cutout</b> For fixed or plug-in mounted circuit breakers. (IP30) 2-Pole & 3-Pole	BZLF3	BZLF3
For breakers with stored energy operator. (IP40)  Circuit-breaker draw-out mounted and toggle handle operated. Kit includes cover frame (bezel) and escutcheon as needed. (IP40) (not for use with rotary handle or stored energy operator)	BZLFRHSE	BZLFRHSE
<b>Toggle Handle Extension</b> For spare or replacement. (One is included with each NG - PG frame.)	—	—



For JG Frame 400 A	For LG Frame 600 A	For MG Frame 800 A	For NG Frame 1200 A	For PG Frame 1600 A
Catalog Number	Catalog Number	Catalog Number	Catalog Number	Catalog Number
— — — NGSJ250 NGSL400 — — — —	— — — — NGSL400 NGSM600 — — — —	— — — — — NGSM600 NGSN800 — — —	— — — — — — NGSN800 NGSP120 —	— — — — — — — NGSP120 NGSP160
EPSP18V	EPSP18V	EPSP18V	EPSP18V	EPSP18V
COMPCA	COMPCA	COMPCA	COMPCA	COMPCA
COMPRO20	COMPRO20	COMPRO20	COMPRO20	COMPRO20
COMMODO21	COMMODO21	COMMODO21	COMMODO21	COMMODO21
COMKIT4	COMKIT4	COMKIT5	COMKIT5	COMKIT5
COMKIT7	COMKIT7	COMKIT8	COMKIT8	COMKIT8
3UF79100AA000	3UF79100AA000	3UF79100AA000	3UF79100AA000	3UF79100AA000
BZLL3	BZLL3	BZLM3	BZLP3	BZLP3
BZLLRHSE	BZLLRHSE	BZLMRHSE	BZLPRHSE	BZLPRHSE
BZLLBDC	BZLLBDC	BZLMBDC	BZLPBDC	BZLPBDC
THEL	THEL	THEM	THEP	THEP

7  
MOLDED CASE  
CIRCUIT BREAKERS

# VL Circuit Breakers

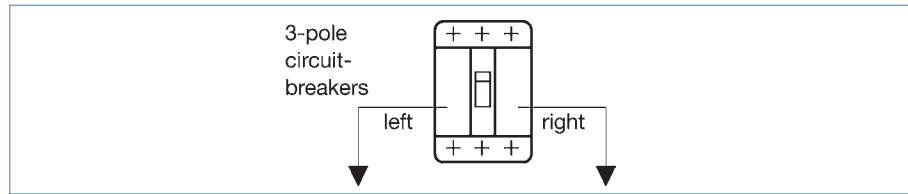

## Locations of Internally Mounted Accessories

Frame Family	Left Pocket	Right Pocket
<b>DG*, FG*, JG, LG</b> 150 to 600A	Up to 3 Auxiliary Switches	Shunt Trip <b>or</b> UVR <b>or</b> up to 3 Auxiliary Switches <b>or</b> up to 2 Auxiliary Switches + 1 Alarm Switch
	Up to 2 Auxiliary Switches + 1 Alarm Switch	Shunt Trip <b>or</b> UVR <b>or</b> up to 3 Auxiliary Switches <b>or</b> up to 2 Auxiliary Switches + 1 Alarm Switch
<b>MG, NG, PG</b> 800 to 1600A	Up to 4 Auxiliary Switches	Shunt Trip <b>or</b> UVR <b>or</b> up to 4 Auxiliary Switches
	Up to 2 Auxiliary Switches + 2 Alarm Switches	Shunt Trip <b>or</b> UVR <b>or</b> up to 4 Auxiliary Switches

\* Except DG and FG breakers with Electronic Trip Units. Due to the location of the Magnetic Latch, the Left Pocket is not available for accessories.

### Accessory Information

- Aux. Switch is an Auxiliary Switch, 1A or 1B contact
- Alarm Switch has 1A or 1B contact
- UVR is an Undervoltage Release
- The standard location for factory mounted Auxiliary and Alarm Switches is the Left Pocket

### Accessory Maximums

#### DG, FG, JG, LG Maximum Accessories:

- Maximum of six (6) switches total
- DG, FG Maximum of two (2) Alarm Switches, one each in the Left and Right Pockets. JG, LG Max. of 1 Alarm, Left only

#### MG, NG, PG Maximum Accessories:

- Maximum of eight (8) switches total
- Maximum of two (2) Alarm Switches, Left Pocket only

### For applications using COMMOD20 and COMMOD21 for communication using Modbus or Profibus

#### DG, FG

COMKIT3 & COMKIT6 provide auxiliary contact kit. May add only one or two contact blocks for Alarm or Auxiliary function.

#### JG, LG

COMKIT4 & COMKIT7 provide auxiliary contact kit mounted in left pole pocket. One contact block can be added for Auxiliary function. Right pole pocket available for other release or an additional Auxiliary contact kit.

#### MG, NG, PG

COMKIT5 & COMKIT8 provide auxiliary contact kit mounted in Left pole pocket. Two contact blocks can be added for Auxiliary function and one for Alarm function. Right pole pocket available for other release or an additional Auxiliary Contact kit.

## Suffix for factory mounted Switch Combinations

If the frame is:	And you need these functions:	Then add this suffix:	Device Catalog Number
DG, FG, JG or LG	1 Alarm Switch 1 NO Alarm 1 NC Alarm	A1	ASKL1
DG, FG, JG or LG	2 Aux. Switches 1 NO + 1 NC Aux. Contacts	A2	ASKL2
DG, FG, JG or LG	2 Aux. + 1 Alarm Switches 1NO + 1NC Aux. and 1NC Alarm 2NO Aux. and 1NC Alarm	A3	ASKL3
MG, NG or PG	2 Aux. + 2 Alarm Switches 1NO + 1NC Aux. and 1NO + 1NC Alarm 2NO Aux. and 2NC Alarm 2NC Aux. and 2NO Alarm	A3	ASKP3
MG, NG or PG	4 Aux. Switches 2NO + 2NC Aux.	A4	ASKP4

## Suffix for factory mounted Shunt Trips

If the frame is:	And you need these functions:	Then add this suffix:	Device Catalog Number
DG, FG, JG or LG	24V DC 48-60V DC 110-127V DC 220-250V DC 48-60V AC 110-127V AC 208-277V AC 380-600V AC	RB RC RD RE RM RN RS RV	STRLB24DC STRLC60DC STRLD125DC STRLE250DC STRLM60 STRLN120 STRLS277 STRLV600
MG, NG or PG	24V DC 48-60V DC 110-127V DC 220-250V DC 48-60V AC 110-127V AC 208-277V AC 380-600V AC	RB RC RD RE RM RN RS RV	STRPB24DC STRPC60DC STRPD125DC STRPE250DC STRPM60 STRPN120 STRPS277 STRPV600

## Suffix for factory mounted Undervoltage Releases

If the frame is:	And you need these functions:	Then add this suffix:	Device Catalog Number
DG, FG, JG or LG	12V DC 24V DC 48V DC 60V DC 110-127V DC 220-250V DC 24V AC 110-127V AC 220-240V AC 208V AC 277V AC 380-415V AC 440-480V AC	UA UB UC UG UD UE UK UN UR UP US UT UU	UVRLA12DC UVRLB24DC UVRLC48DC UVRLG60DC UVRLD125DC UVRLE250DC UVRLL24 UVRLN120 UVRLR240 UVRLP208 UVRLS277 UVRLT415 UVR LU480
MG, NG or PG	12V DC 24V DC 48V DC 60V DC 110-127V DC 220-250V DC 110-127V AC 220-240V AC 208V AC 277V AC 380-415V AC 440-480V AC	UA UB UC UG UD UE UN UR UP US UT UU	UVRPA12DC UVRPB24DC UVRPC48DC UVRPG60DC UVRPD125DC UVRPE250DC UVRPN120 UVRPR240 UVRPP208 UVRPS277 UVRPT415 UVRPU480

# Technical Data

		DG	FG	JG	LG	MG	NG	PG
<b>Max rated continuous current</b>		150	250	400	600	800	1200	1600
Rated operational voltage								
NEMA	V AC	600	600	600	600	600	600	600
IEC	V AC	690	690	690	690	690	690	690
Rated Impulse Withstand Voltage								
Main conducting paths	kV	8	8	8	8	8	8	8
Auxiliary circuits	kV	4	4	4	4	4	4	4
Ambient Temperature Range	°C	-25 to +75	-25 to +75	-25 to +75	-25 to +75	-25 to +75	-25 to +75	-25 to +75
High Ambient Derating (thermal-mag.)	50°C	93%	93%	93%	93%	95%	95%	95%
	60°C	86%	86%	86%	86%	86%	86%	80%
	70°C	80%	80%	80%	80%	80%	80%	74%
Operating Cycles		20,000	20,000	20,000	10,000	5,000	3,000	3,000
Max switching rate (per hour)		120	120	120	60	60	30	30
Power loss (at max. rated current)								
Thermal-magnetic	W	15 – 48	32 – 80	60 – 175	85 – 230	170 – 250	150 – 220	200 – 260
Electronic trip unit	W	40	60	90	160	250	210	260
IEC <sup>①</sup>								
Time constant t = 10 ms								
1 current path								
2 current paths in series								
3 current paths in series								
Up to 250V DC		—	—	—	—	—	—	—
440V DC								
600V DC								
NEMA								
Time constant t = 8 ms								
2 poles switching								
1 current path								
250V DC Max. <sup>②</sup>		30	30	30	30	42	42	42
3 poles switching								
2 current paths in series								
500V DC Max. <sup>②</sup>		18	25	35	35	65	65	65
<b>Accessories</b>								
Auxiliary/ Alarm Switch								
Current rating (1 or 2 switches)		10	10	10	10	10	10	10
Current rating (3 or 4 same switch)	A	5	5	5	5	5	5	5
Shunt Trip								
Pick-up voltage	V	0.7 – 1.1	0.7 – 1.1	0.7 – 1.1	0.7 – 1.1	0.7 – 1.1	0.7 – 1.1	0.7 – 1.1
Power Consumption (short-time) at:								
48 – 60 V AC	VA	401 – 501	401 – 501	401 – 501	401 – 501	401 – 501	401 – 501	401 – 501
110 – 127 V AC	VA	424 – 489	424 – 489	424 – 489	424 – 489	424 – 489	424 – 489	424 – 489
208 – 277 V AC	VA	533 – 736	533 – 736	533 – 736	533 – 736	533 – 736	533 – 736	533 – 736
380 – 600 V AC	VA	408 – 645	408 – 645	408 – 645	408 – 645	408 – 645	408 – 645	408 – 645
24 V DC	W	594	594	594	594	594	594	594
48 – 60 V DC	W	740 – 925	740 – 925	740 – 925	740 – 925	740 – 925	740 – 925	740 – 925
110 – 127 V DC	W	559 – 648	559 – 648	559 – 648	559 – 648	559 – 648	559 – 648	559 – 648
220 – 250 V DC	W	722 – 820	722 – 820	722 – 820	722 – 820	722 – 820	722 – 820	722 – 820
Max. Operating time	ms	50	50	50	50	50	50	50

<sup>①</sup> Consult Siemens for short circuit values.

<sup>②</sup> Review individual frame and type values.

# Technical Data

		DG	FG	JG	LG	MG	NG	PG
<b>Undervoltage Trip</b>								
Drop voltage (percentage)	V	35% – 70%	35% – 70%	35% – 70%	35% – 70%	35% – 70%	35% – 70%	35% – 70%
Pick-up voltage (percentage)	V	70% – 85%	70% – 85%	70% – 85%	70% – 85%	70% – 85%	70% – 85%	70% – 85%
Power consumption (continuous) at:								
110 – 127 V AC	VA	1	1	1	1	1.1	1.1	1.1
220 – 250 V AC	VA	2.1	2.1	2.1	2.1	2.1	2.1	2.1
208 V AC	VA	1.2	1.2	1.2	1.2	1.2	1.2	1.2
277 V AC	VA	1.4	1.4	1.4	1.4	1.4	1.4	1.4
380 – 415 V AC	VA	1.9	1.9	1.9	1.9	1.9	1.9	1.9
440 – 480 V AC	VA	2.2	2.2	2.2	2.2	2.2	2.2	2.2
500 – 525 V AC	VA	2.5	2.5	2.5	2.5	2.5	2.5	2.5
600 V AC	VA	2.8	2.8	2.8	2.8	2.8	2.8	2.8
Max. opening time	ms	50	50	50	50	50	50	50
<b>Motorized Operating Mechanism</b>								
Motor with stored energy mechanism (synchronizable)		X	X	X	X			
Motor Operator						X	X	X
Max. switching rate (per hour)		120	120	120	60	60	30	30
Command duration	ms	20 – 50	20 – 50	20 – 50	20 – 50	20 – 50	—	—
Closing time	ms	<100	<100	<100	<100	<100	<5,000	<5,000
Charging time	s	<5	<5	<5	<5	<5	<5	<5
Break time	s	<5	<5	<5	<5	<5	<5	<5
Power consumption	VA/W	<100	<100	<200	<250	<250		
Inrush (A)								
Control Voltages								
		110 – 127 V AC						
		220 – 250 V AC						
		24 V DC						
		48 V DC						
		60 V DC						
Operating Range		85 – 110% of rated control voltage						

# Technical Data

## Unusual Operating Conditions

Reference

**Note:** The information provided on this and the next page is intended for reference and recommendation only. Because several variables can act on a circuit breaker's performance at the same time, the data below is based less on controlled testing, than on experience and engineering judgment. Contact Siemens for further information on special conditions and treatment.

### High Ambient Temperatures

Because thermal-magnetic trip breakers are temperature sensitive and calibrated for a specific ambient of 40° C (104° F) (average enclosure temperature), a higher ambient will cause the breaker to trip at lower current than its nameplate rating, in other words, causing the breaker to "derate" (see Table 1). Similarly, the current carrying capacity of a circuit conductor is based upon a certain ambient temperature, a higher ambient will reduce its current carrying capacity, causing it to "derate." Thus, with a fluctuating temperature, a thermal-magnetic breaker will derate nearly parallel with its connected circuit conductors and maintain close circuit protection. If the application temperature exceeds 40° C (104° F) and is known, either a breaker specially calibrated for the higher ambient or one oversized according to Table 1 may be selected. In a case such as this, the circuit conductors should be oversized as well.

Siemens Electronic Trip Unit Breakers are insensitive to temperature changes. However, they do include circuitry to protect the components from abnormally high temperatures.

### Altitude

Reduced air density at altitudes greater than 6600 ft. (2000 meters) affects the ability of a molded case circuit breaker to transfer heat and interrupt faults. Therefore, circuit breakers applied at these altitudes should have interrupting, insulation and continuous currents derated as indicated in Figure 1.

**Table 1 – Temperature derating data for thermal-magnetic breakers**

Reference Ampere Rating at 40° C (104° F)	Ampere Rating at:		Siemens Breaker Frames
	50° C (122° F)	60° C (140° F)	
50	46	42	DG
60	56	52	
70	65	60	
90	84	78	
100	94	87	
125	114	100	
150	136	120	
175	159	140	
200	182	160	
225	205	180	
250	235	220	
300	276	252	FG
350	325	301	
400	372	340	JG
500	468	435	
600	564	525	
700	658	613	LG
800	754	704	
900	828	749	MG
1000	900	825	
1200	1090	1000	NG
1400	1304	1148	
1600	1500	1320	PG

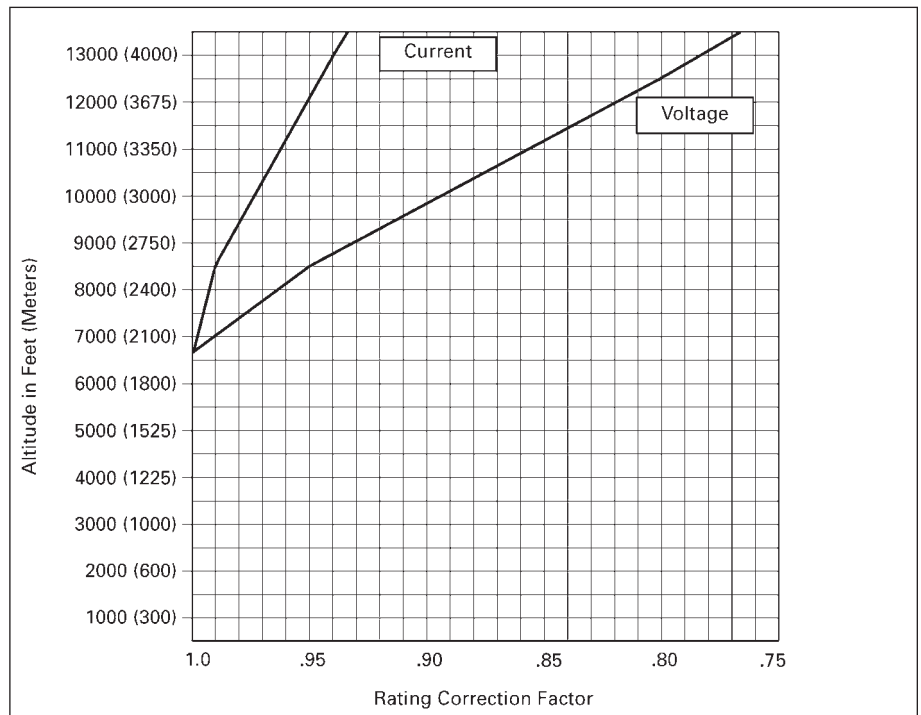

**Figure 1 – Altitude adjustment**

### Unusual Operating Conditions 400 Hz Systems

#### Circuit Breaker Derating Required

This table lists the maximum continuous current carrying capacity for Siemens breakers at 400Hz. Due to the increased resistance of the copper sections resulting from the skin effect produced by eddy currents at these frequencies, circuit breakers in many cases require derating. The thermal derating on these devices is based upon 100%, three phase application in open air in a maximum of 40°C (104° F) with 48 in. (1219 mm) of the specified cable or bus at the line and load side. Additional derating of not less than 20% will be required if the circuit breaker is to be utilized in an enclosure. Further derating may be required if the enclosure ambient temperature exceeds 40°C(104° F).

#### Cable and Bus Sizing

The cable and bus sizes to be utilized at 400Hz are not based on standard National Electric Codes tables for 60Hz application. Larger cross sections are necessary at 400Hz. All bus bars specified are based upon mounting the bars in the vertical plane to allow maximum air flow. All bus bars are spaced at a minimum of 0.25 in. (6 mm) apart. Mounting of bus bars in the horizontal plane will necessitate additional drafting. Edgewise orientation of the bus may change the maximum ratings indicated. If additional information is required for other connections of cable or bus, contact Siemens for information.

#### Application Recommendations

It is recommended that temperatures be measured on the line and load terminals or T-connectors of the center pole. These are usually the hottest terminals with a balanced load. A maximum temperature of 75°C (35°C over a maximum ambient of 40°C) would verify the particular application. Temperature profiles taken on these breakers can be correlated to ensure that the hottest points within the breaker are within the required temperature limits.

#### Interrupting Rating

Circuit breakers used in 400 Hz systems are limited to a 5000 A interrupting rating. If higher ratings are required, consult Siemens.

Breaker type	Maximum continuous ampere rating at 40°C (104°F)②			75°C (167F) Copper cable per pole	
	60HZ		Enclosed after derating	No of pieces	Wire size
	Open air	Open air③			
DG	50	48	38	1	#8
	60	57	46	1	#6
	70	63	50	1	#4
	80	72	58	1	#4
	90	80	64	1	#3
	100	90	72	1	#3
	110	95	75	1	#2
	125	105	84	1	#1
	150	125	100	1	#1/0
FG	100	90	72	1	#3
	110	95	75	1	#2
	125	105	84	1	#1
	150	125	100	1	#1/0
	175	140	112	1	#2/0
	200	160	128	1	#3/0
	225	180	144	1	#4/0
	250	200	160	1	250 kcmil
	250	210	168	1	250 kcmil
JG	300	240	192	1	350 kcmil
	350	260	208	1	500 kcmil
	400	300	240	2	#2/0
	400	300	240	2	#2/0
JG 100% Rated	250	210	210	1	250 kcmil
	300	240	240	1	350 kcmil
	350	260	260	1	500 kcmil
	400	300	300	2	#3/0
LG	400	300	240	2	#3/0
	500	375	300	2	250 kcmil
	600	420	336	2	350 kcmil

Breaker type	Maximum continuous ampere rating at 40°C (104°F)②			75°C (167F) Copper cable per pole	
	60HZ		Enclosed after derating	No of pieces	Wire size
	Open air	Open air③			
LG	400	300	240	2	#3/0
	500	375	300	2	250 kcmil
	600	420	336	2	350 kcmil
MG	600	430	360	2	350 kcmil
	700	500	400	3	250 kcmil
	800	560	448	3	300 kcmil
MG 100% Rated	600	430	430	2	350 kcmil
	700	500	500	3	250 kcmil
	800	560	560	3	300 kcmil
NG	800	560	448	3	300 kcmil
	900	600	480	3	350 kcmil
	1000	650	520	3	400 kcmil
	1200	780	624	4	350 kcmil
NG 100% Rated	900	600	600	3	350 kcmil
	1000	650	650	3	400 kcmil
	1200	780	780	4	350 kcmil
	1200	780	624	4	400 kcmil
PG	1400	850	680	4	500 kcmil
	1600	960	768	5	500 kcmil
	1200	780	780	4	400 kcmil
PG 100% Rated	1400	850	850	4	500 kcmil
	1600	960	960	5	500 kcmil

① The information provided on this page is intended for reference and recommendation only. Because several variables can act on a circuit breaker's performance at the same time, the data above is based less on controlled testing, than on experience and engineering

judgment. Contact Siemens for further information on special conditions and treatment.

② Additional derating may be required if the ambient temperature is greater than 40°C (104°F).

③ Calculated after derating to compensate for the heating of the copper conductor, caused by the skin effect generated by eddy currents produced at 400/415HZ.

# Molded Case Circuit Breakers

## Series Connected Short Circuit Ratings

General

The term "Series Connected Short Circuit Rating" refers to the application of series circuit breakers in a combination that allows downstream breakers to have lower individual interrupting ratings than the available fault current.

This is permitted as long as the series combination has been tested and certified by UL.

The tables on these pages list specific main and branch breaker combinations that may be used for the short circuit interrupting ratings shown.

No substitutions are permitted. All combinations shown have been tested and are UL Listed. This information is provided as a reference tool only. **For verification of specific combination ratings consult the UL Recognized Components Directory.**

### 240V Breaker Series Ratings

Series Rating kAIR	Main Breaker		Branch Breaker			
	Type	Max. Amperes	Type	Number of Poles	Voltage	Amperes
22000	QPH, BQH, BLH	70 (1P) 125 (2P) 100 (3P)	QP, BQ, BL	1	120/240	15-70
				2	240	15-125
				3	240	15-100
			QE, BLE, QPF, BLF	2	120/240	15-60
			QE, BLE, BE, QPF, BQF, BLF QPF2, BLF2	1	240	15-30
			QT	1, 2	120/240	15-40
			QG, BG, BLG	1, 2	120/240	15-30
			BAF, QAF, QAF2, BAF2, QFGA2, BFGA2	1	120	15-20
			BAF, QAF	2	120/240	15-20
	QPMH	200 (2P)	QP	1	120	15-25
				2	120/240	35-70
					15-25	
					35-125	
			QE, QPF	1	120/240	15-30
				2	120/240	15-60
	QJH2	225 (2P, 3P)	QP, BQ, BL	1	120/240	15-70
				2	240	15-125
				3	240	60-100
			QPF, BQF, BLF, BG, BLG	1	120	15-30
			QE, BE, BLE, QPF2, BLF2	1	120	15-30
			QPF, BLF, BG, BLG, QE, BE, BLE	2	120/240	15-60
	QPPH	225 (2P)	BAF, QAF, QAF2, BAF2	1	120	15-20
			BAF, QAF	2	120/240	15-20
			QT	1, 2	120/240	15, 20, 40
			QR2	2, 3	240	100-225
			QP, BQ, BL	1	120/240	15-70
				2	120/240	15-125
			QE, BLE, BE, QPF, BQF, BLF, QPF2, BLF2	1	120	15-30
			QE, BLE, BE, QPF, BLF	2	120/240	15-60
			BAF, QAF, QAF2, BAF2	1	120	15-20
			BAF, QAF	2	120/240	15-20
			QPP	2	120/240	125-200
QRH2	250 (2, 3P)	QP, BQ, BL	1	120/240	15-70	
			2	120/240	15-125	
			3	240	15-125	
			3	240	15-100	
		QG, BG, BLG	1	120	15-30	
			2	120/240	15-30	
		QT	1, 2	120/240	15-50	
		QFGA2, BFGA2, QAF2, BAF2, QAF, BAF	1	120	15-20	
		QAF, BAF	2	120/240	15-20	
		QPF2, BLF2, QPF, BQF, BLF, QE, BLE, BE	1	120	15-30	
		QPF, BLF, QE, BLE	2	120/240	15-60	
		QN, QNR	2	120/240	150-200	
		QS	2	120/240	100-225	
QR2	2	120/240	100-250			
42000	QJ2H	225 (2, 3P)	QP, BQ, BL	1	120/240	15-70
				2	120/240	15-125
				3	240	60-100
			QPH, BQH, BLH	1	120/240	15-70
				2	120/240	15-125
				3	240	15-100
65000	HQP, HBO, HBL	70 (1P) 125 (2P) 100 (3P)	QR2, QRH2	2, 3	240	100-225
			QJH2	2, 3	240	60-225
			QP, BQ, BL, QPH, BQH, BLH	1	120/240	15-70
				2	240	15-125
				3	240	15-100
			QPF, BQF, BLF, BE, QPHF, BQHF, BLHF, QEH, BLEH, QE, BLE, QPF2, BLF2, QPHF2, BLHF2, QPHF2, BLHF2	1	120	15-30
			QEH, BLEH, QE, QPHF, BLHF, BLE, QPF, BLF	2	120/240	15-60
			QT	1, 2	120/240	15-40
			QG, BG, BLG	1, 2	120/240	15-30

### 240V Breaker Series Ratings (continued)

Series Rating kAIR	Main Breaker		Branch Breaker					
	Type	Max. Amperes	Type	Number of Poles	Voltage	Amperes		
65000 (cont.)	HQP, HBO, HBL	70 (1P) 125 (2P) 100 (3P)	BAF, QAF, BQAF, QAF2, BAF2, QAFH2, BAFH2, QFGA2, BFGA2, QF-GAH2, BFGAH2	1	120	15-20		
			BAF, QAF	2	120/240	15-20		
			QP, BQ, BL	1	120/240	15-70		
	ED4, ED4, ED6	100 (1P) 125 (2P, 3P)	QPH, BQH, BLH	2	240	15-125		
				3	240	15-100		
			QPHF, BQHF, BLHF, QPF, BQF, BLF, QE, QEH, BLEH, BE, BLE, QPF2, BLF2, QPHF2, BLHF2	1	120	15-30		
			QEH, BLEH, QE, QPHF, BLHF, BLE, QPF, BLF	2	120/240	15-60		
			QAF2, BAF2, BAF, QAF, BQAF, QAFH2, BAFH2, QAFH, BQAFH, BAFH, QFGA2, BFGA2, QF-GAH2, BFGAH2	1	120	15-20		
			QAF, BAF, QAFH, BAFH	2	120/240	15-20		
			ED2	1, 2, 3	120/240	15-100		
			QT	1, 2	120/240	15-40		
			NDGA, NDGB	150 (2P, 3P)	QPH, BQH, BLH	1	120/240	15-70
				2	240	15-125		
				3	240	15-100		
			HQPP	225 (2P)	QP, BQ, BL, QPH, BQH, BLH	1	120/240	15-70
		2			120/240	15-125		
	QPF, BQF, BLF, QPHF, BQHF, BLHF, QEH, BLEH, QE, BLE, BE, BLF2, QPF2, QFGA2, BFGA2	1			120/240	15-30		
	QEH, BLEH, QE, QPHF, BLHF, BLE, QPF, BLF	2			120/240	15-60		
BAF, QAF, BQAF, QAF2, BAF2, QAFH2, BAFH2, QAFH, BQAFH, QFGAH2, BFGAH2	1	120			15-20			
BAF, QAF, QAFH, BAFH	2	120/240			15-20			
QT	1, 2	120			15-40			
QPPH, QPP	2	120/240			125-200			
FD6-A, FXD6-A	250 (2P, 3P)	QP, BQ, BL			1	120/240	15-70	
					2	120/240	15-125	
			3	240	15-100			
		QPF, QPHF, BLF, BLHF	1, 2	120/240	15-60			
		QPF2, BLF2, QPHF2, BLHF2	1	120	15-30			
			2	120/240	15-60			
		QAF, BAF, QAF2, BAF2, BQAF, QAFH2, BAFH2, QAFH, BQAFH, BAFH, QFGA2, BFGA2, QF-GAH2, BFGAH2	1	120	15-20			
		QAF, BAF, QAFH, BAFH	2	120/240	15-20			
		QR2, QRH2	2, 3	240	100-225			
		QJ2H, QJ2, QJH2	2, 3	240	60-225			
NFGA, NFGB	250 (2P, 3P)	QPPH	2	120/240	125-225			
		QPH, BQH, BLH	1	120/240	15-70			
			2	120/240	15-125			
			3	240	15-100			
		QR2, QRH2	2, 3	240	100-250			
		QP, BQ, BL	1	120/240	15-70			
HQR2			2	120/240	15-125			
			3	240	15-100			
		QT	1, 2	120/240	15-50			
		QFGA2, BFGA2, QAF2, BAF2, QAF, BAF	1	120	15-20			
		QAF, BAF	2	120/240	15-20			
		QPF2, BLF2, QPF, BQF, BLF, QE, BLE, BE	1	120	15-30			
		QPF, BLF, QE, BLE	2	120/240	15-60			
		QPH, BQH, BLH	1	120/240	15-70			
			2	120/240	15-125			
			3	240	15-100			



# Molded Case Circuit Breakers

## Series Connected Short Circuit Ratings

General

### 240V Breaker Series Ratings (continued)

Series Rating kAIR	Main Breaker		Branch Breaker						
	Type	Max. Amperes	Type	Number of Poles	Voltage	Amperes			
65000 (cont.)	HQR2 (cont.)	250 (2P, 3P)	QFGAH2, BFGAH2, QAFH2, BAFH2, QAFH, BAFH	1	120	15-20			
			QAFH, BAFH	2	120/240	15-20			
			QPHF, BLHF, QPHF2, BLHF2, QEH, BLEH	1	120	15-30			
			QEH, BLEH, QPHF, BLHF	2	120/240	15-60			
			QN, QNH, QNR, QNRH	2	120/240	150-200			
			QS, QSH, QSHH	2	120/240	100-225			
			QR2, QRH2	2,3	240	100-250			
	JXD2-A, JD6-A, JXD6-A	400 (2P, 3P)	QPH, BQH, BLH	1	120/240	15-70			
				2	120/240	15-125			
				3	240	15-100			
			QAF2, BAF2, QAFH2, BAFH2, QFGA2, BFGA2, QFGAH2, BFGAH2	1	120	15-20			
			QPF2, BLF2, QPHF2, BLHF2	1	120	15-30			
			QR2, QRH2	2,3	240	100-250			
			QJ2H, QJH2	2,3	240	60-225			
			NJGA, NJJA	400 (2P, 3P)	QPH, BQH, BLH	1	120/240	15-70	
						2	120/240	15-125	
						3	240	15-100	
	QR2, QRH2	2,3			240	100-250			
	QN, QNH	2			120/240	150-200			
	SJD6-A, SJD6-B	400 (2P, 3P)	QPH, BQH, BLH	1	120/240	15-70			
				2	120/240	15-125			
				3	240	15-100			
	HJD6-A, HJXD6	400 (2P, 3P)	QAF2, BAF2, QAFH2, BAFH2, QFGA2, BFGA2, QFGAH2, BFGAH2	1	120	15-20			
				QPF2, BLF2, QPHF2, BLHF2	1	120	15-30		
				QR2, QRH2	2,3	240	100-250		
			QPH	1	120/240	15-70			
				2	120/240	15-125			
	LD6-A, LXD6-A	600 (2P, 3P)	QPH, BQH, BLH	1	120/240	15-70			
				2	120/240	15-125			
				3	240	15-100			
			QR2, QRH2	2,3	240	100-250			
			QAF2, BAF2, QAFH2, BAFH2, QFGA2, BFGA2, QFGAH2, BFGAH2	600 (2P, 3P)	QPH, BQH, BLH	1	120	15-20	
						QPF2, BLF2, QPHF2, BLHF2	1	120	15-30
						QR2, QRH2	2,3	240	100-250
						QPH	1	120/240	15-70
							2	120/240	15-125
			NLGA, NLGB	600 (2P, 3P)	QPH, BQH, BLH	1	120/240	15-70	
						2	120/240	15-125	
						3	240	15-100	
					QR2, QRH2	2,3	240	100-250	
	QAF2, BAF2, QAFH2, BAFH2, QFGA2, BFGA2, QFGAH2, BFGAH2	1			120	15-20			
	SLD6-A, SLD6-B	600 (2P, 3P)	QPH, BQH, BLH	1	120/240	15-70			
				2	120/240	15-125			
				3	240	15-100			
			QAF2, BAF2, QAFH2, BAFH2, QFGA2, BFGA2, QFGAH2, BFGAH2	1	120	15-20			
			QPF2, BLF2, QPHF2, BLHF2	1	120	15-30			
	HLD6-A, HLXD6-A	600 (2P, 3P)	QPH, BQH, BLH	1	120/240	15-70			
2				120/240	15-125				
3				240	15-100				
QAF2, BAF2, QAFH2, BAFH2, QFGA2, BFGA2, QFGAH2, BFGAH2			600 (2P, 3P)	QPH	1	120	15-20		
					QPF2, BLF2, QPHF2, BLHF2	1	120	15-30	
MD6, MXD6	800 (2P, 3P)	QPH, BQH, BLH	1	120/240	15-70				
			2	120/240	15-125				
			3	240	15-100				
		QAF2, BAF2, QAFH2, BAFH2, QFGA2, BFGA2, QFGAH2, BFGAH2	1	120	15-20				
		QPF2, BLF2, QPHF2, BLHF2	1	120	15-30				
QR2, QRH2	2,3	240	100-250						

### 240V Breaker Series Ratings (continued)

Series Rating kAIR	Main Breaker		Branch Breaker					
	Type	Max. Amperes	Type	Number of Poles	Voltage	Amperes		
65000 (cont.)	NMG, HMG	800 (2P, 3P) (cont.)	QPH, BQH, BLH	1	120/240	15-70		
			2	120/240	15-125			
			3	240	15-100			
			QAF2, BAF2, QAFH2, BAFH2, QFGA2, BFGA2, QFGAH2, BFGAH2	1	120	15-20		
			QPF2, BLF2, QPHF2, BLHF2	1	120	15-30		
			QR2, QRH2	2,3	240	100-250		
			QN, QNH	2	120/240	150-200		
			QNR, QNRH	2	120/240	150-200		
			SMD6, SMD6-B	800 (2P, 3P) (cont.)	QPH, BQH, BLH	1	120/240	15-70
						2	120/240	15-125
	3	240				15-100		
	QAF2, BAF2, QAFH2, BAFH2, QFGA2, BFGA2, QFGAH2, BFGAH2	800 (2P, 3P) (cont.)	QPH	1	120	15-20		
				QPF2, BLF2, QPHF2, BLHF2	1	120	15-30	
				QR2, QRH2	2,3	240	100-250	
	HMXD6, HMD6	800 (2P, 3P) (cont.)	QPH	1	120/240	15-70		
				2	120/240	15-125		
				3	240	15-100		
	QAF2, BAF2, QAFH2, BAFH2, QFGA2, BFGA2, QFGAH2, BFGAH2	800 (2P, 3P) (cont.)	QPH	1	120	15-20		
				QPF2, BLF2, QPHF2, BLHF2	1	120	15-30	
				QR2, QRH2	2,3	240	100-250	
	ND6, NXD	1200 (2P, 3P)	QPH, BQH, BLH	1	120/240	15-70		
				2	120/240	15-125		
				3	240	15-100		
			QAF2, BAF2, QAFH2, BAFH2, QFGA2, BFGA2, QFGAH2, BFGAH2	1	120	15-20		
			QPF2, BLF2, QPHF2, BLHF2	1	120	15-30		
	NNG, HNG	1200 (2P, 3P)	QPH, BQH, BLH	1	120/240	15-70		
				2	120/240	15-125		
				3	240	15-100		
			QAF2, BAF2, QAFH2, BAFH2, QFGA2, BFGA2, QFGAH2, BFGAH2	1	120	15-20		
			QPF2, BLF2, QPHF2, BLHF2	1	120	15-30		
	SND6, SND6-B	1600 (2P, 3P)	QPH, BQH, BLH	1	120/240	15-70		
				2	120/240	15-125		
				3	240	15-100		
QAF2, BAF2, QAFH2, BAFH2, QFGA2, BFGA2, QFGAH2, BFGAH2			1	120	15-20			
QPF2, BLF2, QPHF2, BLHF2			1	120	15-30			
HND6, HNXD6	1600 (2P, 3P)	QPH, BQH, BLH	1	120/240	15-70			
			2	120/240	15-125			
			3	240	15-100			
		QAF2, BAF2, QAFH2, BAFH2, QFGA2, BFGA2, QFGAH2, BFGAH2	1	120	15-20			
		QPF2, BLF2, QPHF2, BLHF2	1	120	15-30			
SPD6, SPD6-B, PD6, PXD6	1600 (2P, 3P)	QPH, BQH, BLH	1	120/240	15-70			
			2	120/240	15-125			
			3	240	15-100			
		QR2, QRH2	2,3	240	100-250			
		NPG	1600 (2P, 3P)	QPH, BQH, BLH	1	120/240	15-70	
2	120/240				15-125			
3	240				15-100			
QR2, QRH2	2,3			240	100-250			
QN, QNH	2			120/240	150-200			
HPD6, HPXD6	1600 (2P, 3P)	QPH	1	120/240	15-70			
			2	120/240	15-125			
			3	240	15-100			
		QAF2, BAF2, QAFH2, BAFH2, QFGA2, BFGA2, QFGAH2, BFGAH2	1	120	15-20			
		QPF2, BLF2, QPHF2, BLHF2	1	120	15-30			
HRD6, HRXD6	2000 (2P, 3P)	QPH	1	120/240	15-70			
			2	120/240	15-125			
			3	240	15-100			
		QR2, QRH2	2,3	240	100-250			
		RD6, RXD6	2000 (2P, 3P)	QPH, BQH, BLH	1	120/240	15-70	
2	120/240				15-125			
3	240				15-100			
QAF2, BAF2, QAFH2, BAFH2, QFGA2, BFGA2, QFGAH2, BFGAH2	2000 (2P, 3P)			QPH	1	120	15-20	
					QPF2, BLF2, QPHF2, BLHF2	1	120	15-30
QR2, QRH2	2,3	240	100-250					

MOLDED CASE CIRCUIT BREAKERS

# Molded Case Circuit Breakers

## Series Connected Short Circuit Ratings

General

### 240V Breaker Series Ratings (continued)

Series Rating kAIR	Main Breaker		Branch Breaker					
	Type	Max. Amperes	Type	Number of Poles	Voltage	Amperes		
100000	HED4, HED6	100 (1P)	ED2, ED4	1	120	15-100		
			QP, BQ, BL, OPH, BOH, BLH, HQP, HBQ, HBL	1	120/240	15-70		
				2	240	15-125		
				3	240	15-100		
			QAF2, BAF2, QAF, BQAF, BAF, QAFH2, BAFH2, HQAF2, HBAF2, QAFH, BOAFH, BAFH, QFGA2, BFGA2, HQFGA2, HBF-GA2, QFGAH2, BFGAH2	1	120	15-20		
			QAF, BAF, QAFH, BAFH	2	120/240	15-20		
			QEH, BLEH, QE, BE, QPHF, BQHF, BLHF, QPF, BLF, BOF, BLE, QPF2, BLF2, QPHF2, BLHF2, HQPF2, HBLF2	1	120	15-30		
			QEH, BLEH, QPHF, QE, BLHF, QPF, BLF, BLE	2	120/240	15-60		
			ED2	1,2,3	120/240	15-100		
			ED4	1	120	15-100		
			ED4, ED6	2,3	240	15-125		
			OT	1,2	120/240	15-40		
			NGB, HGB, LBG	125 (2P, 3P)	QAF2, QAFH2, QAF, BQAF, BAF, BAFH2, HQAF2, HBAF2, QAFH, BOAFH, BAFH, QFGA2, BFGA2, HQFGA2, HBF-GA2, QFGAH2, BFGAH2	1	120	15-20
					QAF, BAF, QAFH, BAFH	2	120/240	15-20
					QPF, BQF, BLF, QPHF, BQHF, BLHF, QPF2, BLF2, QPHF2, BLHF2, HQPF2, HBLF2	1	120	15-30
	QPF, BLF	2			120/240	15-60		
	QP, BQ, BL, OPH, BQH, BLH, HQP, HBQ, HBL	1			120	15-70		
		2			120/240	15-125		
	NGB, HGB, LBG	150 (2P, 3P)	ED4, ED6	1	240	15-100		
			ED4, ED6	2,3	240	15-125		
			NDGA, NDGB	2,3	240	50-150		
	HQPPH	225 (2P)	QP, BO, BL, OPH, BQH, BLH, HQP, HBQ, HBL	1	120/240	15-70		
				2	120/240	15-125		
			HQPP, QPPH, QPP	2	120/240	125-225		
			QAF2, BAF2, QAF, BQAF, BAF, QAFH2, BAFH2, HQAF2, HBAF2, QAFH, BOAFH, BAFH, QFGA2, BFGA2, HQFGA2, HBF-GA2, QFGAH2, BFGAH2	1	120	15-20		
			QAF, BAF, QAFH, BAFH	2	120/240	15-20		
			QEH, BLEH, QE, BE, QPHF, BQHF, BLHF, QPF, BOF, BLF, BLE, QPF2, BLF2, QPHF2, BLHF2, HQPF2, HBLF2	1	120	15-30		
			QE, QEH, BLEH, QPHF, BLHF, QPF, BLF, BLE	2	120/240	15-60		
			QR2, QRH2, HQR2	2	120/240	100-225		
			OT	1,2	120/240	15-40		
HJQ2H			225 (2P, 3P)	QP, BP, QL	1	120/240	15-25	
					2	120/240	35-70	
					3	240	15-100	
				QR2, QRH2, HQR2	2,3	240	100-225	
				QPH, BQH, BLH, HQP, HBQ, HBL	1	120/240	15-70	
					2	120/240	15-125	
		3		240	15-100			
	QAF2, BAF2, QAF, BQAF, BAF, QAFH2, BAFH2, HQAF2, HBAF2, QAFH, BOAFH, BAFH, QFGA2, BFGA2, HQFGA2, HBF-GA2, QFGAH2, BFGAH2	1		120	15-20			
	QAF, BAF, QAFH, BAFH	2		120/240	15-20			
	QEH, BLEH, QE, BE, QPHF, BQHF, BLHF, QPF, BOF, BLF, BLE, QPF2, BLF2, HQPF2, HBLF2, QPHF2, BLHF2	1		120	15-30			
	QEH, BLEH, QPHF, BLE, BLHF, QE, QPF, BLF	2		120/240	15-60			
	OT	1		120/240	15-50			

### 240V Breaker Series Ratings (continued)

Series Rating kAIR	Main Breaker		Branch Breaker			
	Type	Max. Amperes	Type	Number of Poles	Voltage	Amperes
100000 (cont.)	HFD6, HFXD6	250 (2P, 3P)	QP, BQ, BL, OPH, BOH, BLH, HQP, HBQ, HBL	1	120/240	15-70
				2	120/240	15-125
				3	240	15-100
			QAF2, BAF2, QAF, BQAF, BAF, QAFH2, BAFH2, HQAF2, HBAF2, QAFH, BOAFH, BAFH, QFGA2, BFGA2, HQFGA2, HBF-GA2, QFGAH2, BFGAH2	1	120	15-20
			QAF, BAF, QAFH, BAFH	2	120/240	15-20
			QE, BE, BLE, QPHF, BQHF, BLHF, QPF, BOF, BLF, QEH, BLEH, QPF2, BLF2, HQPF2, HBLF2, QPHF2, BLHF2	1	120	15-30
			QPF, BLF, BLE, BLEH, QPHF, BLHF, QEH, QE	2	120/240	15-60
			ED4	1	120	15-100
			ED4, ED6	2,3	240	15-125
			FD6-A, FXD6-A	2,3	240	70-250
			QJ2, QJH2, QJ2H	2,3	240	60-225
			HQPP, QPPH, QPP	2	120/240	125-225
			QR2, QRH2, HQR2	2,3	240	100-250
			OT	1,2	120/240	15-40
			HFGA, HFGB	250 (2P, 3P)	NDGA, NDGB	2, 3
	NFGA, NFGB	2, 3			240	70-250
	ED4, ED6	1			240	15-100
	ED4, ED6	2,3			240	15-125
	NFGA, NFGB	2, 3			240	70-250
	QAF2, BAF2, QAFH2, BAFH2, HQAF2, HBAF2, QFGA2, BFGA2, HQFGA2, HBF-GA2, QFGAH2, BFGAH2	1			120	15-20
	QPF2, BLF2, HQPF2, HBLF2, QPHF2, BLHF2	1			120	15-30
	QR2, QRH2, HQR2	2,3			240	100-250
	FD6, FXD6	2, 3			240	70-250
	FD6-A, FXD6-A	2, 3			240	70-250
	QP, BQ, BL	1			120/240	15-70
		2			120/240	15-125
		3			240	15-100
	OT	1,2			120/240	15-50
	HQR2H	250 (2P, 3P)			QFGA2, BFGA2, QAF2, BAF2, QAF, BAF	1
			QAF, BAF	2	120/240	15-20
			QPF2, BLF2, QPF, BOF, BLF, QE, BLE, BE	1	120	15-30
			QPF, BLF, QE, BLE	2	120/240	15-60
			QPH, BQH, BLH	1	120/240	15-70
				2	120/240	15-125
				3	240	15-100
			QFGAH2, BFGAH2, QAFH2, BAFH2, HQFGA2, HBF-GA2, HQAF2, HBAF2, QAFH, BAFH	1	120	15-20
			QAFH, BAFH	2	120/240	15-20
			QPHF, BLHF, QPHF2, BLHF2, QEH, BLEH, HQPF2, HBLF2	1	120	15-30
			QEH, BLEH, QPHF, BLHF	2	120/240	15-60
			HQP, HBQ, HBL	1	120/240	15-70
				2	120/240	15-125
				3	240	15-100
			OS, OSH, QSHH, HOS	2	120/240	100-225
	QR2, QRH2, HQR2	2,3	240	100-250		
	HJD6-A, HJXD6-A	400 (2P, 3P)	ED4	1	120	15-100
ED4, ED6			2, 3	240	15-125	
QAF2, BAF2, QAFH2, BAFH2, HQAF2, HBAF2, QFGA2, BFGA2, HQFGA2, HBF-GA2, QFGAH2, BFGAH2			1	120	15-20	
QPF2, BLF2, HQPF2, HBLF2, QPHF2, BLHF2			1	120	15-30	
QR2, QRH2, HQR2			2,3	240	100-250	
FD6-A, FXD6-A			2, 3	240	70-250	
JD6-A, JXD6-A			2, 3	240	200-400	
JXD2-A, SJD6-A			2, 3	240	200-400	
NDGA, NDGB			2, 3	240	50-150	
NFGA, NFGB			2, 3	240	70-250	
NJGA, NJJA			2, 3	240	200-400	

# Molded Case Circuit Breakers

## Series Connected Short Circuit Ratings

General

### 240V Breaker Series Ratings (continued)

Series Rating kAIR	Main Breaker		Branch Breaker		
	Type	Max. Amperes	Type	Number of Poles	Voltage Amperes
100000 (cont.)	HJGA	400 (2P, 3P)	ED4, ED6	1	240 15-100
			ED4, ED6	2,3	240 15-125
			QAF2, BAF2, QAFH2, BAFH2, HQAF2, HBAF2, QFGA2, BFGA2 HQFGA2, HBFGA2, QFGAH2, BFGAH2	1	120 15-20
			QPF2, BLF2, HQPF2, HBLF2, QPHF2, BLHF2	1	120 15-30
			NFGA, NFGB	2, 3	240 70-250
			FD6, FXD6	2, 3	240 70-250
			FD6-A, FXD6-A	2, 3	240 70-250
			QR2, QRH2, HQR2	2,3	240 100-250
			NJGA, NJJA	2, 3	240 200-400
			JD6, JXD6	2, 3	240 200-400
			JD6-A, JXD6-A	2, 3	240 200-400
			ED4	1	120 15-100
			ED4, ED6	2, 3	240 15-125
			FD6-A, FXD6-A	2, 3	240 70-250
			JD6-A, JXD6-A	2, 3	240 200-400
			JXD2-A, SJD6-A, SJD6-B	2, 3	240 200-400
	SHJD6, SHJD6-A, SHJD6-B	400 (3P)	QAF2, BAF2, QAFH2, BAFH2, HQAF2, HBAF2, QFGA2, BFGA2 HQFGA2, HBFGA2, QFGAH2, BFGAH2	1	120 15-20
			QPF2, BLF2, HQPF2, HBLF2, QPHF2, BLHF2	1	120 15-30
			QR2, QRH2, HQR2	2,3	240 100-250
			NDGA, NDGB	2, 3	240 50-150
			NFGA, NFGB	2, 3	240 70-250
			NJGA, NJJA	2, 3	240 200-400
			ED4	1	120 15-100
			ED4, ED6	2,3	240 15-125
			QAF2, BAF2, QAFH2, BAFH2, HQAF2, HBAF2, QFGA2, BFGA2 HQFGA2, HBFGA2, QFGAH2, BFGAH2	1	120 15-20
			QPF2, BLF2, HQPF2, HBLF2, QPHF2, BLHF2	1	120 15-30
	HLD6-A, HLXD6-A	600 (2P, 3P)	FD6-A, FXD6-A	2,3	240 70-250
			JD6-A, JXD6-A, JXD2-A, SJD6-A, SJD6-B	2,3	240 200-400
			LD6-A	2,3	240 200-600
			LXD6-A	2,3	240 450-600
			SLD6-A, SLD6-B	3	240 300-600
			QR2, QRH2, HQR2	2,3	240 100-250
			NDGA, NDGB	2, 3	240 50-150
			NFGA, NFGB	2, 3	240 70-250
			NJGA, NJJA	2, 3	240 200-400
			NLGA, NLGB	2, 3	240 400-600
			ED4, ED6	1	240 15-100
			ED4, ED6	2,3	240 15-125
			NFGA, NFGB	2, 3	240 70-250
			FD6, FXD6	2, 3	240 70-250
			FD6-A, FXD6-A	2, 3	240 70-250
			NJGA, NJJA	2, 3	240 200-400
			JD6, JXD6	2, 3	240 200-400
	JD6-A, JXD6-A	2, 3	240 200-400		
	NLGA, NLGB	2, 3	240 400-600		
	HLGA, HLGB	600 (2P, 3P)	QAF2, BAF2, QAFH2, BAFH2, HQAF2, HBAF2, QFGA2, BFGA2 HQFGA2, HBFGA2, QFGAH2, BFGAH2	1	120 15-20
			QPF2, BLF2, HQPF2, HBLF2, QPHF2, BLHF2	1	120 15-30
			QR2, QRH2, HQR2	2,3	240 100-250
			LD6, LD6-A	2, 3	240 200-600
			LXD6, LXD6-A	2, 3	240 450-600
ED4			1	120 15-100	
ED4, ED6			2,3	240 15-125	
FD6-A, FXD6-A			2,3	240 70-250	
JD6-A, JXD6-A			2,3	240 200-400	
SJD6-A, SJD6-B			2,3	240 200-400	
LD6-A			2,3	240 200-600	
LXD6-A			2,3	240 450-600	
SLD6-A, SLD6-B			3	240 300-600	
SHLD6, SHLD6-A, SHLD6-B	600 (3P)	QAF2, BAF2, QAFH2, BAFH2, HQAF2, HBAF2, QFGA2, BFGA2 HQFGA2, HBFGA2, QFGAH2, BFGAH2	1	120 15-20	
		QPF2, BLF2, HQPF2, HBLF2, QPHF2, BLHF2	1	120 15-30	
		QR2, QRH2, HQR2	2,3	240 100-250	
		LD6, LD6-A	2, 3	240 200-600	
		LXD6, LXD6-A	2, 3	240 450-600	
		ED4	1	120 15-100	
		ED4, ED6	2,3	240 15-125	
		FD6-A, FXD6-A	2,3	240 70-250	
		JD6-A, JXD6-A, JXD2-A, SJD6-A, SJD6-B	2,3	240 200-400	
		LD6-A	2,3	240 200-600	
		LXD6-A	2,3	240 450-600	

### 240V Breaker Series Ratings (continued)

Series Rating kAIR	Main Breaker		Branch Breaker		
	Type	Max. Amperes	Type	Number of Poles	Voltage Amperes
100000 (cont.)	SHLD6, SHLD6-A, SHLD6-B (cont.)	600 (3P) (cont.)	QR2, QRH2, HQR2	2,3	240 100-250
			NDGA, NDGB	2, 3	240 50-150
			NFGA, NFGB	2, 3	240 70-250
			NJGA, NJJA	2, 3	240 200-400
			NLGA, NLGB	2, 3	240 400-600
			ED4, ED6	1	240 15-100
			ED4, ED6	2,3	240 15-125
			NFGA, NFGB	2, 3	240 70-250
			FD6, FXD6	2, 3	240 70-250
			FD6-A, FXD6-A	2, 3	240 70-250
			NJGA, NJJA	2, 3	240 200-400
			JD6, JXD6	2, 3	240 200-400
			JD6-A, JXD6-A	2, 3	240 200-400
			NLGA, NLGB	2, 3	240 400-600
			LD6, LD6-A	2, 3	240 200-600
			LXD6, LXD6-A	2, 3	240 450-600
	NMG	2, 3	240 600-800		
	HMG	800 (2P, 3P)	QAF2, BAF2, QAFH2, BAFH2, HQAF2, HBAF2, QFGA2, BFGA2 HQFGA2, HBFGA2, QFGAH2, BFGAH2	1	120 15-20
			QPF2, BLF2, HQPF2, HBLF2, QPHF2, BLHF2	1	120 15-30
			QR2, QRH2, HQR2	2,3	240 100-250
			LMD6, LMXD6	2, 3	240 600-800
			MD6, MXD6	2, 3	240 400-800
			NDGA, NDGB	2, 3	240 50-150
			NFGA, NFGB	2, 3	240 70-250
			NJGA, NJJA	2, 3	240 200-400
			NLGA, NLGB	2, 3	240 400-600
			NMG	2, 3	240 600-800
	HMD6, HMXD6	800 (2P, 3P)	ED4	1	120 15-100
			ED4, ED6	2,3	240 15-125
			FD6-A, FXD6-A	2,3	240 70-250
			JD6-A, JXD6-A, JXD2-A, SJD6-A	2,3	240 200-400
			LD6-A	2,3	240 200-600
			LXD6-A	2,3	240 450-600
			QAF2, BAF2, QAFH2, BAFH2, HQAF2, HBAF2, QFGA2, BFGA2 HQFGA2, HBFGA2, QFGAH2, BFGAH2	1	120 15-20
			QPF2, BLF2, HQPF2, HBLF2, QPHF2, BLHF2	1	120 15-30
			QR2, QRH2, HQR2	2,3	240 100-250
			SLD6-A, SLD6-B	3	240 300-600
			MD6, MXD6	2,3	240 500-800
			SMD6, SMD6-B	3	240 600-800
			NDGA, NDGB	2, 3	240 50-150
			NFGA, NFGB	2, 3	240 70-250
			NJGA, NJJA	2, 3	240 200-400
			NLGA, NLGB	2, 3	240 400-600
			SHMD6, SHMD6-B	800 (3P)	NMG
	ED4	1			120 15-100
	ED4, ED6	2,3			240 15-125
	FD6-A, FXD6-A	2,3			240 70-250
	JD6-A, JXD6-A, JXD2-A	2,3			240 200-400
	SJD6-A, SJD6-B	2,3			240 200-400
	LD6-A	2,3			240 200-600
LXD6-A	2,3	240 450-600			
QAF2, BAF2, QAFH2, BAFH2, HQAF2, HBAF2, QFGA2, BFGA2 HQFGA2, HBFGA2, QFGAH2, BFGAH2	1	120 15-20			
QPF2, BLF2, HQPF2, HBLF2, QPHF2, BLHF2	1	120 15-30			
QR2, QRH2, HQR2	2,3	240 100-250			
SLD6-A, SLD6-B	3	240 300-600			
MD6, MXD6, SMD6, SMD6-B	2,3	240 500-800			
HNG	1200 (2P, 3P)	ED4, ED6	1	240 15-100	
		ED4, ED6	2,3	240 15-125	
		NFGA, NFGB	2, 3	240 70-250	
		FD6, FXD6	2, 3	240 70-250	
		FD6-A, FXD6-A	2, 3	240 70-250	
		NJGA, NJJA	2, 3	240 200-400	
		JD6, JXD6	2, 3	240 200-400	
		JD6-A, JXD6-A	2, 3	240 200-400	
		NLGA, NLGB	2, 3	240 400-600	
		LD6, LD6-A	2, 3	240 200-600	
		LXD6, LXD6-A	2, 3	240 450-600	

MOLDED CASE CIRCUIT BREAKERS

# Molded Case Circuit Breakers

Series Connected Short Circuit Ratings

General

## 240V Breaker Series Ratings (continued)

Series Rating kAIR	Main Breaker		Branch Breaker			
	Type	Max. Amperes	Type	Number of Poles	Voltage	Amperes
100000 (cont.)	HNG (cont.)	1200 (2P, 3P)	QAF2, BAF2, QAFH2, BAFH2, HQAF2, HBAF2, QFGA2, BFGA2 HQFGA2, HBFGA2, QFGAH2, BFGAH2	1	120	15-20
			QPF2, BLF2, HQPF2, HBLF2, QPHF2, BLHF2	1	120	15-30
			QR2, QRH2, HQR2	2,3	240	100-250
			NMG	2,3	240	600-800
			LMD6, LMXD6	2,3	240	600-800
			NNG	2,3	240	800-1200
			ND6, NXD6	2,3	240	600-1200
			ED4	1	240	15-100
			ED4, ED6	2,3	240	15-125
			FD6-A, FXD6-A	2,3	240	70-250
			JD6-A, JXD6-A, JXD2-A, SJD6-A	2,3	240	200-400
			LD6-A	2,3	240	200-600
			LXD6-A	2,3	240	450-600
			SLD6-A, SLD6-B	3	240	300-600
			MD6, MXD6, SMD6	2,3	240	500-800
	HND6, HNXD6	1200 (3P)	QAF2, BAF2, QAFH2, BAFH2, HQAF2, HBAF2, QFGA2, BFGA2 HQFGA2, HBFGA2, QFGAH2, BFGAH2	1	120	15-20
			QPF2, BLF2, HQPF2, HBLF2, QPHF2, BLHF2	1	120	15-30
			QR2, QRH2, HQR2	2,3	240	100-250
			NDGA, NDGB	2,3	240	50-150
			NFGA, NFGB	2,3	240	70-250
			NJGA, NJJA	2,3	240	200-400
			NLGA, NLGB	2,3	240	400-600
			NMG	2,3	240	600-800
			NNG	2,3	240	800-1200
			ED4	1	240	15-100
			ED4, ED6	2,3	240	15-125
			FD6-A, FXD6-A	2,3	240	70-250
			JD6-A, JXD6-A, JXD2-A, SJD6-A	2,3	240	200-400
			LD6-A	2,3	240	200-600
			LXD6-A	2,3	240	450-600
	SLD6-A, SLD6-B	3	240	300-600		
	MD6, MXD6, SMD6, SMD6-B	2,3	240	500-800		
	ND6, NXD6, SND6, SND6-B	2,3	240	500-1200		
	SHND6, SHND6-B	1200 (3P)	QAF2, BAF2, QAFH2, BAFH2, HQAF2, HBAF2, QFGA2, BFGA2 HQFGA2, HBFGA2, QFGAH2, BFGAH2	1	120	15-20
			QPF2, BLF2, HQPF2, HBLF2, QPHF2, BLHF2	1	120	15-30
			QR2, QRH2, HQR2	2,3	240	100-250
			NDGA, NDGB	2,3	240	50-150
			NFGA, NFGB	2,3	240	70-250
			NJGA, NJJA	2,3	240	200-400
			NLGA, NLGB	2,3	240	400-600
			NMG	2,3	240	600-800
			NNG	2,3	240	800-1200
			ED4	1	240	15-100
			ED4, ED6	2,3	240	15-125
			FD6-A, FXD6-A	2,3	240	70-250
JD6-A, JXD6-A, JXD2-A, SJD6-A			2,3	240	200-400	
LD6-A			2,3	240	200-600	
LXD6-A			2,3	240	450-600	
SLD6-A, SLD6-B	3	240	300-600			
MD6, MXD6, SMD6, SMD6-B	2,3	240	500-800			
ND6, NXD6, SND6, SND6-B	2,3	240	500-1200			
HPG	1600 (2P, 3P)	ED4, ED6	1	240	15-100	
		ED4, ED6	2,3	240	15-125	
		NFGA, NFGB	2,3	240	70-250	
		FD6, FXD6	2,3	240	70-250	
		FD6-A, FXD6-A	2,3	240	70-250	
		NJGA, NJJA	2,3	240	200-400	
		JD6, JXD6	2,3	240	200-400	
		JD6-A, JXD6-A	2,3	240	200-400	
		NLGA, NLGB	2,3	240	400-600	
		LD6, LD6-A	2,3	240	200-600	
		LXD6, LXD6-A	2,3	240	450-600	
		QR2, QRH2, HQR2	2,3	240	100-250	
		NMG	2,3	240	600-800	
		LMD6, LMXD6	2,3	240	600-800	
		MD6, MXD6	2,3	240	400-800	
NNG	2,3	240	800-1200			
ND6, NXD6	2,3	240	600-1200			
NPG	2,3	240	1200-1600			
PD6, PXD6	2,3	240	1200-1600			

## 240V Breaker Series Ratings (continued)

Series Rating kAIR	Main Breaker		Branch Breaker			
	Type	Max. Amperes	Type	Number of Poles	Voltage	Amperes
100000 (cont.)	HPD6, HPXD6, SHPD6 SHPD6-B	1600 (3P)	ED4	1	240	15-100
			ED4, ED6	2,3	240	15-125
			JD6-A, JXD6-A, JXD2-A	2,3	240	200-400
			SJD6-A, SJD6-B	3	240	200-400
			LD6-A	2,3	240	200-600
			LXD6-A	2,3	240	450-600
			SLD6-A, SLD6-B	3	240	300-600
			MD6, MXD6, SMD6, SMD6-B	2,3	240	500-800
			ND6, NXD6, SND6, SND6-B	2,3	240	500-1200
			PD6, PXD6	2,3	240	1200-1600
			SPD6, SPD6-B	3	240	1400-1600
			QR2, QRH2, HQR2	2,3	240	100-250
			NDGA, NDGB	2,3	240	50-150
			NFGA, NFGB	2,3	240	70-250
			NJGA, NJJA	2,3	240	200-400
	NLGA, NLGB	2,3	240	400-600		
	NMG	2,3	240	600-800		
	NNG	2,3	240	800-1200		
	NPG	2,3	240	1200-1600		
	ED4	1	240	15-100		
	ED4, ED6	2,3	240	15-125		
	FD6-A, FXD6-A	2,3	240	70-250		
	JD6-A, JXD6-A, JXD2-A	2,3	240	200-400		
	SJD6-A, SJD6-B	3	240	200-400		
	LD6-A	2,3	240	200-600		
	LXD6-A	2,3	240	450-600		
	SLD6-A, SLD6-B	3	240	300-600		
	MD6, MXD6, SMD6, SMD6-B	2,3	240	500-800		
	ND6, NXD6, SND6, SND6-B	2,3	240	500-1200		
	NPG, PD6, PXD6	2,3	240	1200-1600		
	SPD6, SPD6-B	3	240	1400-1600		
	NDGA, NDGB	2,3	240	50-150		
	NFGA, NFGB	2,3	240	70-250		
	NJGA, NJJA	2,3	240	200-400		
	NLGA	2,3	240	400-600		
	NMG	2,3	240	600-800		
	NNG	2,3	240	800-1200		
	NPG	2,3	240	1200-1600		
	ED4	1	240	15-100		
	ED4, ED6	2,3	240	15-125		
	JD6-A, JXD6-A, JXD2-A	2,3	240	200-400		
	SJD6-A, SJD6-B	3	240	200-400		
	LD6-A	2,3	240	200-600		
	LXD6-A	2,3	240	450-600		
	SLD6-A, SLD6-B	3	240	300-600		
MD6, MXD6, SMD6, SMD6-B	2,3	240	500-800			
ND6, NXD6, SND6, SND6-B	2,3	240	500-1200			
PD6, PXD6	2,3	240	1200-1600			
SPD6, SPD6-B	3	240	1200-1600			
RD6, RXD6	2,3	240	1600-2000			
QR2, QRH2, HQR2	2,3	240	100-250			
NDGA, NDGB	2,3	240	50-150			
NFGA, NFGB	2,3	240	70-250			
NJGA, NJJA	2,3	240	200-400			
NLGA, NLGB	2,3	240	400-600			
NMG	2,3	240	600-800			
NNG	2,3	240	800-1200			
NPG	2,3	240	1200-1600			
SHPD6, SHPD6-B	125 (2P, 3P)	QP, BQ, BL	1	120/240	15-70	
		QPH, BQH, BLH, HQP, HBQ, HBL	2	120/240	15-125	
		QAF2, BAF2, QAF, BQAF, BAF, QAFH2, BAFH2, HQAF2, HBAF2, QAFH, BQAFH, BAFH, HQFGA2, HBFGA2, QFGA2, QFGAH2, BFGAH2	1	120	15-20	
		BAF, QAF, BAFH, QAFH	2	120/240	15-20	
		QPHF, BQHF, BLHF, QPF, BQF, BLF, QEH, QE, BE, BLEH, BLE	1	120	15-30	
		QEH, BLEH, QAFH, QE, QPHF, BLHF, QPF, BLE, BLF	2	120/240	15-60	
		ED4, HED4	1	120	15-100	
		ED4, ED6, HED4, HED6	2,3	240	15-125	
		QT	1,2	120/240	15-40	
		NGB, HGB, LBG	1,2,3	240	15-125	

7  
MOLDED CASE  
CIRCUIT BREAKERS

# Molded Case Circuit Breakers

## Series Connected Short Circuit Ratings

General

### 240V Breaker Series Ratings (continued)

Series Rating kAIR	Main Breaker		Branch Breaker			
	Type	Max. Amperes	Type	Number of Poles	Voltage	Amperes
200000 (cont.)	LDGA, LDGB	150 (2P, 3P)	NGB,HGB,LBG	1,2,3	240	15-125
			NDGA, NDGB, HDGA, HDGB	2, 3	240	50-150
	CFD6	250 (2P, 3P)	QP, BQ, BL, QPH, BQH, BLH, HQP, HBQ, HBL	1 2 3	120/240 120/240 240	15-70 15-125 15-100
			QAF2, BAF2, QAF, BQAF, BAF, QAFH2, BAFH2, HQAF2, HBAF2, QAFH, BOAFH, BAFH, HQFGA2, HBFGA2, QFGA2, QF- GAH2, BFGAH2	1	120	15-20
			BAF, QAF, BAFH, QAFH	2	120/240	15-20
			QPHF, BQHF, BLHF, QE, BE, BLE, QPF, BQF, BLF, QEH, BLEH, QAF, BAF	1	120	15-30
			QPHF, BLHF, QE, BLE, QPF, BLF, QEH, BLEH, QAF, BAF	2	120/240	15-60
			ED2	1,2,3	120/240	15-100
			HED4, ED4	1	120	15-100
			ED4, ED6, HED4, HED6	2,3	240	15-125
			FD6-A, FXD6-A HFD6, HFXD6	2,3	240	70-250
			QJ2H, QJH2, QJ2	2,3	240	60-225
			QPPH, QPP	2	120/240	125-225
			QT	1,2	120/240	15-40
			NGB,HGB,LBG	1,2,3	240	15-125
			NDGA, NDGB, HDGA, HDGB	2, 3	240	50-150
	LFGA, LFGB		NFGA, NFGB, HFGA, HFGB	2, 3	240	70-250
			NGB,HGB,LBG	1,2,3	240	15-125
	CJD6-A	400 (2P, 3P)	NDGA, NDGB, HDGA, HDGB	2, 3	240	50-150
			NFGA, NFGB, HFGA, HFGB		240	70-250
			HFD6, HFXD6		240	70-250
			QPH, BQH, BLH, HQF, HBO, HBL	2 3	120/240 240	100-125 100
			ED4, ED6	2,3	240	15-125
			FD6-A, FXD6-A HFD6, HFXD6	2,3	240	70-250
			JXD2-A, JD6-A, JXD6-A, HJD6-A, HJXD6-A	2,3	240	200-400
			QT	1,2	120/240	15-30
			NGB,HGB,LBG	1,2,3	240	15-125
			NDGA, NDGB, HDGA, HDGB	2, 3	240	50-150
			NFGA, NFGB, HFGA, HFGB		240	70-250
			NJGA, HJGA, NJJA		240	200-400
			NGB,HGB,LBG	1,2,3	240	15-125
			NDGA, NDGB, HDGA, HDGB	2, 3	240	50-150
	LJGA		NFGA, NFGB, HFGA, HFGB		240	70-250
			HFD6, HFXD6		240	70-250
	HHJD6, HHJXD6		NJGA, HJGA, NJJA		240	200-400
			FD6-A, FXD6-A HFD6, HFXD6	2 3	240	70-250
	HHLD6, HHLXD6	600 (2P, 3P)	NDGA, NDGB, HDGA, HDGB	2, 3	240	50-150
			NFGA, NFGB, HFGA, HFGB		240	70-250
			NJGA, HJGA, NJJA		240	200-400
			NLGA, HLGA, NLGB, HLGB		240	400-600
QPH, BQH, BLH HQF, HBO, HBL			2 3	120/240 240	100-125 100	
ED4, ED6			2,3	240	15-125	
CLD6-A		FD6-A, FXD6-A HFD6, HFXD6	2,3	240	70-250	
		JXD2-A, JD6-A, JXD6-A, HJD6-A, HJXD6-A	2,3	240	200-400	
		LD6-A, HLD6-A	2,3	240	200-600	

### 240V Breaker Series Ratings (continued)

Series Rating kAIR	Main Breaker		Branch Breaker			
	Type	Max. Amperes	Type	Number of Poles	Voltage	Amperes
200000 (cont.)	CLD6-A (cont.)	600 (2P, 3P)	LXD6-A, HJXD6-A	2,3	240	450-600
			QT	1,2	120/240	15-30
			NGB,HGB,LBG	1,2,3	240	15-125
			NDGA, NDGB, HDGA, HDGB	2 - 3	240	50-150
			NFGA, NFGB, HFGA, HFGB		240	70-250
			NJGA, HJGA, NJJA		240	200-400
			NLGA, HLGA, NLGB, HLGB		240	400-600
			NGB,HGB,LBG	1,2,3	240	15-125
			NDGA, NDGB, HDGA, HDGB	2, 3	240	50-150
			NFGA, NFGB, HFGA, HFGB		240	70-250
			HFD6, HFXD6		240	70-250
			NJGA, HJGA, NJJA		240	200-400
			NLGA, HLGA, NLGB, HLGB		240	400-600
			CMD6	800 (2P, 3P)	ED4	1
	ED4, ED6, HED4, HED6	2,3			240	15-125
	FD6-A, FXD6-A, HFD6, HFXD6	2,3			240	70-250
	JXD2-A, JD6-A, JXD6-A, HJD6-A HJXD6-A	2,3			240	200-400
	LD6-A, HLD6-A	2,3			240	200-600
	LXD6-A, HLXD6-A	2,3			240	450-600
	MD6, MXD6, HMD6, HMXD6	2,3			240	500-800
	NDGA, NDGB, HDGA, HDGB	2,3			240	50-150
	NFGA, NFGB, HFGA, HFGB	2,3			240	70-250
	NJGA, HJGA, NJJA	2,3			240	200-400
	NLGA, HLGA, NLGB, HLGB	2,3			240	400-600
	NMG, HMG	2,3			240	600-800
	HFD6, HFXD6	2,3			240	70-250
	MD6, MXD6	2,3			240	400-800
	LMG	800 (3P)	HMD6, HMXD6	2,3	240	400-800
			NDGA, NDGB, HDGA, HDGB	2,3	240	50-150
			NFGA, NFGB, HFGA, HFGB	2,3	240	70-250
			NJGA, HJGA, NJJA	2,3	240	200-400
			NLGA, HLGA, NLGB, HLGB	2,3	240	400-600
			NMG, HMG	2,3	240	600-800
			MD6, MXD6, HMD6, HMXD6	2,3	240	500-800
			NDGA, NDGB, HDGA, HDGB	2,3	240	50-150
			NFGA, NFGB, HFGA, HFGB	2,3	240	70-250
			NJGA, HJGA, NJJA	2,3	240	200-400
			NLGA, HLGA, NLGB, HLGB	2,3	240	400-600
			NMG, HMG	2,3	240	600-800
			SCMD6, SCMD6-A SCMD6-B	800 (3P)		
CND6-A			1200 (2P, 3P)	ED4, ED6	1	240
	ED4, ED6, HED4, HED6	2,3		240	15-125	
	FD6-A, FXD6-A, HFD6, HFXD6	2,3		240	70-250	
	JXD2-A, JD6-A, JXD6-A, HJD6-A, HJXD6-A	2,3		240	200-400	
	LD6-A, HLD6-A	2,3		240	200-600	
	LXD6-A, HLXD6-A	2,3		240	450-600	
	MD6, MXD6, HMD6, HMXD6	2,3		240	500-800	
	ND6, NXD6, SHND6, HND6,HNXD6	2,3		240	500-1200	
	NDGA, NDGB, HDGA, HDGB	2,3		240	50-150	
	NFGA, NFGB, HFGA, HFGB	2,3		240	70-250	
	NJGA, HJGA, NJJA	2,3		240	200-400	
	NLGA, HLGA, NLGB, HLGB	2,3		240	400-600	
	NMG, HMG	2,3		240	600-800	

MOLDED CASE  
CIRCUIT BREAKERS

# Molded Case Circuit Breakers

## Series Connected Short Circuit Ratings

General

### 240V Breaker Series Ratings (continued)

Series Rating kAIR	Main Breaker		Branch Breaker			
	Type	Max. Amperes	Type	Number of Poles	Voltage	Amperes
200000 (cont.)	LNG	1200 (2P, 3P)	HFD6, HFXD6	2,3	240	70-250
			MD6, MXD6	2,3	240	400-800
			HMD6, HMXD6	2,3	240	400-800
			ND6,NXD6,HND6,HNXD6	2,3	240	600-1200
			NDGA, NDGB, HDGA, HDGB	2,3	240	50-150
			NFGA, NFGB, HFGA, HFGB	2,3	240	70-250
			NJGA, HJGA, NJJA	2,3	240	200-400
			NLGA, HLGA, NLGB, HLGB	2,3	240	400-600
			NMG, HMG	2,3	240	600-800
	SCND6-A, SCND6-B	1200 (3P)	MD6, HMD6, HMXD6, MXD6	2,3	240	400-800
			SHMD6, SMD6, SHMD6-B, SMD6-B	2,3	240	400-800
			NMG, HMG	2,3	240	600-800
			ND6, HND6, NXD6, HNXD6	2,3	240	500-1200
			SHND6, SND6, SHND6-B, SND6-B	3	240	500-1200
	SCND6-A, SCND6-B	1200 (2P, 3P)	NDGA, NDGB, HNDGA, NDGB	2,3	240	50-150
			NFGA, NFGB, HFGA, HFGB	2,3	240	70-250
			NJGA, HJGA, NJJA	2,3	240	200-400
			NLGA, HLGA, NLGB, HLGB	2,3	240	400-600
			NMG, HMG	2,3	240	600-800
	CPD6	1600 (3P)	FD6-A, FXD6-A, HFD6, HFXD6	2,3	240	70-250
			JXD2-A, JD6-A, JXD6-A, HJD6-A, HJXD6-A	2,3	240	200-400
			LD6-A, HLD6-A	2,3	240	200-600
			LXD6-A, HLXD6-A	2,3	240	450-600
			MD6, MXD6, HMD6, HMXD6	2,3	240	500-800
			ND6, NXD6, HND6, HNXD6, SND6	2,3	240	500-1200
			NDGA, NDGB, HDGA, HDGB	2,3	240	50-150
			NFGA, NFGB, HFGA, HFGB	2,3	240	70-250
			NJGA, HJGA, NJJA	2,3	240	200-400
			NLGA, HLGA, NLGB, HLGB	2,3	240	400-600
			NMG, HMG	2,3	240	600-800
			MD6, MXD6, HMD6, HMXD6	2,3	240	400-800
			ND6, NXD6, HND6, HNXD6	2,3	240	600-1200
			PD6, PXD6, HPD6, HPXD6	2,3	240	1000-1600
			NDGA, NDGB, HDGA, HDGB	2,3	240	50-150
			NFGA, NFGB, HFGA, HFGB	2,3	240	70-250
			NJGA, HJGA, NJJA	2,3	240	200-400
			NLGA, HLGA, NLGB, HLGB	2,3	240	400-600
	NMG, HMG	2,3	240	600-800		
	LPG	1600 (2P, 3P)	ND6, NXD6, HND6, HNXD6	2,3	240	600-1200
			PD6, PXD6, HPD6, HPXD6	2,3	240	1000-1600
NDGA, NDGB, HDGA, HDGB			2,3	240	50-150	
NFGA, NFGB, HFGA, HFGB			2,3	240	70-250	
HFD6, HFXD6			2,3	240	70-250	
NJGA, HJGA, NJJA			2,3	240	200-400	
NLGA, HLGA, NLGB, HLGB			2,3	240	400-600	
NMG, HMG			2,3	240	600-800	

### 480V Breaker Series Ratings

Series Rating kAIR	Main Breaker		Branch Breaker				
	Type	Max. Amperes	Type	Number of Poles	Voltage	Amperes	
18,000	ED4	125 (2 & 3P)	BQD, CQD	1,2,3	15-100	277/480	
25,000	ED6	125 (2P & 3P)	BQD, CQD	1,2,3	15-100	277/480	
	NGB, HGB, LBG		BQD, CQD	1	15-100	277	
				2	15-100	277/480	
HED6	BQD, CQD	1,2,3	15-100	277/480			
		1	15-100	277			
35,000	FD6-A, FXD6-A	250 (2P & 3P)	NGB,HGB,LBG	1	15-125	277	
				2	15-125	277/480	
				3	15-125	277/480	
	JD6-A, JXD6-A		NGB,HGB,LBG	1	15-125	277	
				2	15-125	277/480	
				3	15-125	277/480	
42,000	HED4	125 (2P & 3P)	BQD, CQD	1,2,3	15-100	277/480	
				1	15-100	277	
	HJD6-A, HJXD6-A		NGB,HGB,LBG	1	15-125	277	
				2	15-125	277/480	
50,000	HFD6, HFXD6	250 (2P & 3P)	NGB,HGB,LBG	1	15-125	277	
				2	15-125	277/480	
				3	15-125	277/480	
	HJD6-A, HJXD6-A, HLD6-A, HLXD6-A		HED4	2,3	15-50	480	
	MD6, MXD6		800 (2P & 3P)	FD6-A, FXD6-A	2,3	70-250	480
				JD6-A, JXD6-A	2,3	200-400	480
				SJD6-A, SJD6-B	3	200-400	480
				LD6-A	2,3	200-600	480
				LXD6-A	2,3	450-600	480
				SLD6-A, SLD6-B	3	400-600	480
NDGA, NDGB		2,3		50-150	480		
NFGA, NFGB		2,3		70-250	480		
NJGA		2,3		250-400	480		
NLGA, NLGB		2,3		400-600	480		
NMG		2,3		600-800	480		
SMD6 SMD6-B		800 (3P)		JD6-A, JXD6-A	2,3	200-400	480
	SJD6-A, SJD6-B		3	200-400	480		
	LD6-A		2,3	200-600	480		
	LXD6-A		2,3	450-600	480		
	SLD6-A, SLD6-B		3	400-600	480		
	LMD6, LMXD6		2,3	600-800	480		
	NDGA, NDGB		2,3	50-150	480		
	NFGA, NFGB		2,3	70-250	480		
	NJGA		2,3	250-400	480		
	NLGA, NLGB		2,3	400-600	480		
	NMG		2,3	600-800	480		
	ND6, NXD6		1200 (2P & 3P)	FD6-A, FXD6-A	2,3	70-250	380
JD6-A, JXD6-A		2,3		200-400	480		
SJD6-A, SJD6-B		3		200-400	480		
LD6-A		2,3		200-600	480		
LXD6-A		2,3		450-600	480		
SLD6-A, SLD6-B		3		400-600	480		
NDGA, NDGB		2,3		50-150	480		
NFGA, NFGB		2,3		70-250	480		
NJGA		2,3		250-400	480		
NLGA, NLGB		2,3		400-600	480		
NMG, LMD6, LMXD6		2,3		600-800	480		
SND6 SND6-B		1200 (3P)		JD6-A, JXD6-A	2,3	200-400	480
	SJD6-A, SJD6-B		3	200-400	480		
	LD6-A		2,3	200-600	480		
	LXD6-A		2,3	450-600	480		
	SLD6-A, SLD6-B		3	400-600	480		
	LMD6, LMXD6		2,3	600-800	480		
	NDGA, NDGB		2,3	50-150	480		
	NFGA, NFGB		2,3	70-250	480		
	NJGA		2,3	250-400	480		
	NLGA, NLGB		2,3	400-600	480		
	NMG		2,3	600-800	480		
	SPD6, SPD6-B		1600 (3P)	JD6-A, JXD6-A	2,3	200-400	480
SJD6-A, SJD6-B		3		200-400	480		
LD6-A		2,3		200-600	480		
LXD6-A		2,3		450-600	480		

# Molded Case Circuit Breakers

## Series Connected Short Circuit Ratings

General

### 480V Breaker Series Ratings (continued)

Series Rating kAIR	Main Breaker		Branch Breaker			
	Type	Max. Amperes	Type	Number of Poles	Voltage	Amperes
50,000 (cont.)	PD6, PXD6	1600 (3P)	FD6-A, FXD6-A	2,3	70-250	480
			JD6-A, JXD6-A	2,3	200-400	480
			SJD6-A	3	200-400	480
			LD6-A	2,3	200-600	480
			LXD6-A	2,3	450-600	480
			SLD6-A, SLD6-B	3	400-600	480
			NDGA, NDGB	2,3	50-150	480
			NFGA, NFGB	2,3	70-250	480
			NJGA	2,3	250-400	480
			NLGA, NLGB	2,3	400-600	480
			NMG	2,3	600-800	480
			NNG	2,3	800-1200	480
			NPG	2,3	1200-1600	480
			FD6-A, FXD6-A	2,3	70-250	480
			JD6-A, JXD6-A	2,3	200-400	480
			SJD6-A, SJD6-B	3	200-400	480
			LD6-A	2,3	200-600	480
			LXD6-A	2,3	450-600	480
	SLD6-A, SLD6-B	3	400-600	480		
	NDGA, NDGB	2,3	50-150	480		
	NFGA, NFGB	2,3	70-250	480		
	NJGA	2,3	250-400	480		
	NLGA, NLGB	2,3	400-600	480		
	NMG	2,3	600-800	480		
	NNG	2,3	800-1200	480		
	NPG	2,3	1200-1600	480		
	HDGA, HDGB	150 (2P & 3P)	NDGA, NDGB	2,3	50-150	480
	HFD6, HFXD6	250 (2P & 3P)	BQD, COD	1,2,3	15-100	277/480
			ED4, HED4	1	15-100	277
			ED4, ED6, HED4, HED6	2,3	15-125	480
	HFGA, HFGB	250 (2P & 3P)	NDGA, NDGB	2,3	50-150	480
			NFGA, NFGB	2,3	70-250	480
			NDGA, NDGB	2,3	50-150	480
	HJD6-A, HJXD6-A	400 (2P & 3P)	HED4, ED4	1	15-100	277
			FD6-A, FXD6-A	2,3	70-250	480
			JD6-A, JXD6-A	2,3	200-400	480
			NDGA, NDGB	2,3	50-150	480
			NFGA, NFGB	2,3	70-250	480
			NJGA	2,3	250-400	480
			NDGA, NDGB	2,3	50-150	480
	NFGA, NFGB	2,3	70-250	480		
	HJGA	400 (2P & 3P)	NDGA, NDGB	2,3	50-150	480
			NFGA, NFGB	2,3	70-250	480
			NJGA	2,3	250-400	480
	HHJD6, HHJXD6	400 (2P & 3P)	NGB,HGB,LBG	1	15-125	277
NGB,HGB,LBG			2	15-125	277/480	
NGB,HGB,LBG			3	15-125	277/480	
65,000	HLD6-A, HLXD6-A	600 (2P & 3P)	ED4, HED4	1	15-100	277
			FD6-A, FXD6-A	2,3	70-250	480
			JD6-A, JXD6-A	2,3	200-400	480
			LD6-A	2,3	200-600	480
			LXD6-A	2,3	450-600	480
			NDGA, NDGB	2,3	50-150	480
			NFGA, NFGB	2,3	70-250	480
			NJGA	2,3	250-400	480
			NLGA, NLGB	2,3	400-600	480
	HHLD6, HHLXD6	600 (2P & 3P)	NGB,HGB,LBG	1	15-125	277
			NGB,HGB,LBG	2	15-125	277/480
			NGB,HGB,LBG	3	15-125	277/480
	HLGA, HLGB	600 (2P & 3P)	NGB,HGB,LBG	1	15-125*	277
			NGB,HGB,LBG	2	15-125*	277/480
			NGB,HGB,LBG	3	15-125*	277/480
NDGA, NDGB	2,3	50-150	480			
NFGA, NFGB	2,3	70-250	480			
NJGA	2,3	250-400	480			
NLGA, NLGB	2,3	400-600	480			
HMD6, HMXD6	800 (2P & 3P)	FD6-A, FXD6-A	2,3	70-250	480	
		JD6-A, JXD6-A	2,3	200-400	480	
		LD6-A	2,3	200-600	480	
		LXD6-A	2,3	450-600	480	
		LMD6, LMXD6	2,3	600-800	480	
		MD6, MXD6	2,3	400-800	480	
		NDGA, NDGB, NDGB	2,3	50-150	480	
		NFGA, NFGB	2,3	70-250	480	
		NJGA	2,3	250-400	480	
		NLGA, NLGB	2,3	400-600	480	
NMG	2,3	600-800	480			

### 480V Breaker Series Ratings (continued)

Series Rating kAIR	Main Breaker		Branch Breaker				
	Type	Max. Amperes	Type	Number of Poles	Voltage	Amperes	
65,000 (cont.)	HMG	800 (2P & 3P) (cont.)	LMD6, LMXD6	2,3	600-800	480	
			MD6, MXD6	2,3	400-800	480	
			SMD6, SMD6-B	3	500-800	480	
			NDGA, NDGB, NDGB	2,3	50-150	480	
			NFGA, NFGB	2,3	70-250	480	
			NJGA	2,3	250-400	480	
			NLGA, NLGB	2,3	400-600	480	
			NMG	2,3	600-800	480	
			FD6-A, FXD6-A	2,3	70-250	480	
			JD6-A, JXD6-A	2,3	200-400	480	
			LD6-A	2,3	200-600	480	
			LXD6-A	2,3	450-600	480	
			MD6, MXD6	2,3	500-800	480	
			SMD6, SMD6-B	3	500-800	480	
			LMD6, LMXD6	2,3	600-800	480	
			NDGA, NDGB, NDGB	2,3	50-150	480	
			NFGA, NFGB	2,3	70-250	480	
			NJGA	2,3	250-400	480	
	NLGA, NLGB	2,3	400-600	480			
	NMG	2,3	600-800	480			
	NNG	2,3	800-1200	480			
	HND6, HNXD6	1200 (2P & 3P)	LMD6, LMXD6	2,3	600-800	480	
			MD6, MXD6	2,3	400-800	480	
			SMD6, SMD6-B	3	500-800	480	
			LMD6, LMXD6	2,3	600-800	480	
			NDGA, NDGB, NDGB	2,3	50-150	480	
			NFGA, NFGB	2,3	70-250	480	
			NJGA	2,3	250-400	480	
			NLGA, NLGB	2,3	400-600	480	
			NMG	2,3	600-800	480	
			NNG	2,3	800-1200	480	
			LMD6, LMXD6	2,3	600-800	480	
			MD6, MXD6	2,3	400-800	480	
			ND6, NXD6	2,3	800-1200	480	
			NDGA, NDGB, NDGB	2,3	50-150	480	
			NFGA, NFGB	2,3	70-250	480	
			NJGA	2,3	250-400	480	
			NLGA, NLGB	2,3	400-600	480	
			NMG	2,3	600-800	480	
	NNG	2,3	800-1200	480			
	HNG	1600 (3P)	LMD6, LMXD6	2,3	600-800	480	
			MD6, MXD6	2,3	400-800	480	
			ND6, NXD6	2,3	800-1200	480	
			NDGA, NDGB, NDGB	2,3	50-150	480	
			NFGA, NFGB	2,3	70-250	480	
			NJGA	2,3	250-400	480	
			NLGA, NLGB	2,3	400-600	480	
			NMG	2,3	600-800	480	
			NNG	2,3	800-1200	480	
			FD6-A, FXD6-A	2,3	70-250	480	
			NDGA, NDGB, NDGB	2,3	50-150	480	
			NFGA, NFGB	2,3	70-250	480	
			NJGA	2,3	250-400	480	
			NLGA, NLGB	2,3	400-600	480	
NMG			2,3	600-800	480		
NNG			2,3	800-1200	480		
HPD6, HPXD6			1600 (3P)	LMD6, LMXD6	2,3	600-800	480
				MD6, MXD6	2,3	400-800	480
	ND6, NXD6	2,3		800-1200	480		
	NDGA, NDGB, NDGB	2,3		50-150	480		
	NFGA, NFGB	2,3		70-250	480		
	NJGA	2,3		250-400	480		
	NLGA, NLGB	2,3		400-600	480		
	NMG	2,3		600-800	480		
	NNG	2,3		800-1200	480		
	NPG	2,3		1200-1600	480		
	LMD6, LMXD6	2,3		600-800	480		
	MD6, MXD6	2,3		400-800	480		
	ND6, NXD6	2,3		800-1200	480		
	NDGA, NDGB, NDGB	2,3		50-150	480		
	NFGA, NFGB	2,3		70-250	480		
	NJGA	2,3		250-400	480		
	NLGA, NLGB	2,3		400-600	480		
	NMG	2,3		600-800	480		
HPG	1600 (2P & 3P)	LMD6, LMXD6	2,3	600-800	480		
		MD6, MXD6	2,3	400-800	480		
		ND6, NXD6	2,3	800-1200	480		
		NDGA, NDGB, NDGB	2,3	50-150	480		
		NFGA, NFGB	2,3	70-250	480		
		NJGA	2,3	250-400	480		
		NLGA, NLGB	2,3	400-600	480		
		NMG	2,3	600-800	480		
		NNG	2,3	800-1200	480		
		NPG	2,3	1200-1600	480		
		FD6-A, FXD6-A	2,3	70-250	480		
		JD6-A, JXD6-A	2,3	200-400	480		
		LD6-A	2,3	200-600	480		
		LXD6-A	2,3	450-600	480		
		NDGA, NDGB	2,3	50-150	480		
		NFGA, NFGB	2,3	70-250	480		
		NJGA	2,3	250-400	480		
		NLGA, NLGB	2,3	400-600	480		
NMG	2,3	600-800	480				
HRD6, HRXD6	18-2000 (3P)	LMD6, LMXD6	2,3	600-800	480		
		MD6, MXD6	2,3	400-800	480		
		ND6, NXD6	2,3	800-1200	480		
		NDGA, NDGB, NDGB	2,3	50-150	480		
		NFGA, NFGB	2,3	70-250	480		
		NJGA	2,3	250-400	480		
		NLGA, NLGB	2,3	400-600	480		
		NMG	2,3	600-800	480		
		NNG	2,3	800-1200	480		
		NPG	2,3	1200-1600	480		
		FD6-A, FXD6-A	2,3	70-250	480		
		JD6-A, JXD6-A	2,3	200-400	480		
		LD6-A	2,3	200-600	480		
		LXD6-A	2,3	450-600	480		
		NDGA, NDGB	2,3	50-150	480		
		NFGA, NFGB	2,3	70-250	480		
		NJGA	2,3	250-400	480		
		NLGA, NLGB	2,3	400-600	480		
NMG	2,3	600-800	480				
100,000	LDGA, LDGB	150 (2P & 3P)	NGB,HGB,LBG	1	15-125*	277	
	LDGA, LDGB	150 (2P & 3P)	NGB,HGB,LBG	2	15-125*	277/480	
	LDGA, LDGB	150 (2P & 3P)	NGB,HGB,LBG	3	15-125*	277/480	
	CFD6	250 (2P & 3P)	BQD, CQD	1	15-100	277/480	
	CFD6		2,3	15-30	277/480		
	LFGA, LFGB		NGB,HGB,LBG	1	15-125*	277	
			NGB,HGB,LBG	2	15-125*	277/480	
			NGB,HGB,LBG	3	15-125*	277/480	
	LFGA, LFGB		NDGA, NDGB, HDGA, HDGB	2,3	50-150	480	
			NFGA, NFGB, HFGA, HFGB	2,3	70-250	480	
			HFD6, HFXD6	2,3	70-250	480	
	HHFD6, HHFXD6		NGB,HGB,LBG	1	15-125*	277	
			NGB,HGB,LBG	2	15-125*	277/480	
			NGB,HGB,LBG	3	15-125*	277/480	

MOLDED CASE CIRCUIT BREAKERS

# Molded Case Circuit Breakers

## Series Connected Short Circuit Ratings

General

### 480V Breaker Series Ratings (continued)

Series Rating kAIR	Main Breaker		Branch Breaker				
	Type	Max. Amperes	Type	Number of Poles	Voltage	Amperes	
100,000 (cont.)	HHJXD6, HHJD6,	400 (2P, 3P)	ED4, ED6, HED4, HED6	1	15-100	277	
			HFD6, HFXD6, FXD6-A, FD6-A	2,3	70-250	480	
			NDGA, NDGB, HDGA, HDGB	2,3	50-150	480	
			NFGA, NFGB, HFGA, HFGB	2,3	70-250	480	
			NJGA, HJGA	2,3	200-400	480	
				1	15-125*	277	
	CJD6-A		1	15-125*	277/480		
			2	15-125*	277/480		
			3	15-125*	277/480		
	LJGA		NDGA, NDGB, HDGA, HDGB	2,3	50-150	480	
			NFGA, NFGB, HFGA, HFGB	2,3	70-250	480	
			HFD6, HFXD6	2,3	70-250	480	
	HHLXD6, HHLXD6	600 (2P, 3P)	ED4, ED6, HED4, HED6	1	15-100	277	
			HFD6, HFXD6, FXD6-A, FD6-A	2,3	70-250	480	
			NDGA, NDGB, HDGA, HDGB	2,3	50-150	480	
			NFGA, NFGB, HFGA, HFGB	2,3	70-250	480	
			NJGA, HJGA	2,3	200-400	480	
				2,3	50-150	480	
	LLGA, LLGB		NDGA, NDGB, HDGA, HDGB	2,3	70-250	480	
			HFD6, HFXD6	2,3	70-250	480	
			NJGA, HJGA	2,3	200-400	480	
	CMD6	800 (3P)	FD6-A, FXD6-A, HFD6-A, HFXD6-A	2,3	70-250	480	
			JD6-A, HJD6-A, JXD6-A, HJXD6-A	2,3	200-400	480	
			LD6-A, HLD6-A	2,3	200-600	480	
			LXD6-A, HLXD6-A	2,3	450-600	480	
			MD6, MXD6, HMD6, HMXD6	2,3	500-800	480	
			NDGA, NDGB, HDGA, HDGB	2,3	50-150	480	
			NFGA, NFGB, HFGA, HFGB	2,3	70-250	480	
NJGA, HJGA			2,3	200-400	480		
NLGA, HLGA, NLGB, HLGB			2,3	400-600	480		
			2,3	500-800	480		
			2,3	70-250	480		
			2,3	400-600	480		
LMG	800 (2P, 3P)	NDGA, NDGB, HDGA, HDGB	2,3	50-150	480		
		NFGA, NFGB, HFGA, HFGB	2,3	70-250	480		
		HFD6, HFXD6	2,3	70-250	480		
		NJGA, HJGA	2,3	200-400	480		
		NLGA, NLGB, HLGA, HLGB	2,3	400-600	480		
		MD6, MXD6, HMD6, HMXD6	2,3	500-800	480		
SCMD-A SCMD6-B	800 (3P)	HFD6, HFXD6	2,3	70-250	480		
SCND6-A SCND6-B	1200 (3P)	HFD6, HFXD6	2,3	70-250	480		
LNG	1200 (2P, 3P)	NDGA, NDGB, HDGA, HDGB	2,3	50-150	480		
		NFGA, NFGB, HFGA, HFGB	2,3	70-250	480		
		HFD6, HFXD6	2,3	70-250	480		
		NJGA, HJGA	2,3	200-400	480		
		NLGA, HLGA, NLGB, HLGB	2,3	400-600	480		
		MD6, MXD6, HMD6, HMXD6	2,3	400-800	480		
		ND6, NXD6, HND6, HNXD6	2,3	600-1200	480		

### 480V Breaker Series Ratings (continued)

Series Rating kAIR	Main Breaker		Branch Breaker			
	Type	Max. Amperes	Type	Number of Poles	Voltage	Amperes
100,000 (cont.)	CND6	1200 (3P)	FD6-A, FXD6-A	2,3	70-250	480
			HFD6-A, HFXD6-A	2,3	70-250	480
			JD6-A, HJD6-A, JXD6-A, HJXD6-A	2,3	200-400	480
			LD6-A, HLD6-A	2,3	200-600	480
			LXD6-A, HLXD6-A	2,3	450-600	480
			MD6, MXD6, HMD6, HMXD6	2,3	500-800	480
			ND6, NXD6, HND6, HNXD6	2,3	500-1200	480
			NDGA, NDGB, HDGA, HDGB	2 - 3	50-150	480
			NFGA, NFGB, HFGA, HFGB		70-250	480
			NJGA, HJGA		200-400	480
			NLGA, HLGA, NLGB, HLGB		400-600	480
			CPD6	1600 (3P)	FD6-A, FXD6-A, HFD6-A, HFXD6-A	2,3
	NDGA, NDGB, HDGA, HDGB	2,3			50-150	480
	NFGA, NFGB, HFGA, HFGB	2,3			70-250	480
	NJGA, HJGA	2,3			200-400	480
	NLGA, HLGA, NLGB, HLGB	2,3			400-600	480
		2,3			50-150	480
	LPG (2,3P)	1600 (2P, 3P)	NDGA, NDGB, HDGA, HDGB	2,3	70-250	480
			NFGA, NFGB, HFGA, HFGB	2,3	70-250	480
			HFD6, HFXD6	2,3	70-250	480
			NJGA, HJGA	2,3	200-400	480
			NLGA, NLGB, HLGA, HLGB	2,3	400-600	480
			MD6, MXD6, HMD6, HMXD6	2,3	500-800	480
	ND6, NXD6, HND6, HNXD6	2,3	500-1200	480		
	PD6, PXD6, HPD6, HFXD6	2,3	1200-1600	480		
	CJD6-A	400 (2P, 3P)	ED4	1	15-100	277
			HFD6, HFXD6	2,3	70-250	480
			JD6-A, HJD6-A, JXD6-A, HJXD6-A	2,3	200-400	480
			1	15-100	277	
HFD6, HFXD6			2,3	70-250	480	
JD6-A, HJD6-A, JXD6-A, HJXD6-A			2,3	200-400	480	
CLD6-A	600 (2P, 3P)	LD6-A, HLD6-A	2,3	200-600	480	
		LXD6-A, HLXD6-A	2,3	450-600	480	
			1	15-100	277	
		ED4, HED4	1	15-100	277	
		ED4, ED6, HED4, HED6	2,3	15-125	480	
		NGB,HGB, LBG	1	15-125	277	
2	15-125	277/480				
3	15-125	277/480				
CED6	125 (2P, 3P)	BQD, CQD	1	15-100	277	
			2,3	20-30	277/480	
		ED4, HED4	1	15-100	277	
		ED4, ED6, HED4, HED6	2,3	15-125	480	
			1	15-100	277	
			2,3	20-30	277/480	
CFD6	250 (2P, 3P)	BQD, CQD	1	15-100	277	
			2,3	20-30	277/480	
		ED4, ED6	2,3	15-50	277	
		ED4, HED4	1	15-100	480	
		HED4, HED6	2,3	15-125	480	
		FD6-A, FXD6-A, HFD6, HFXD6	2,3	70-250	480	
			1	15-125	277	
			2	15-125	277/480	
			3	15-125	277/480	



# Molded Case Circuit Breakers

Series Connected Short Circuit Ratings

General

## 240V Fuse Series Ratings

Series Rating kAIR	Main Fuse		Branch Breaker			
	Type	Max. Amperes	Type	Number of Poles	Max. Amperes	
65,000	J, R	15-600 (1,2,3P)	OPH, BOH, BLH	1,2,3	15-125	
	T	15-1200 (1,2,3P)	OPH, BOH, BLH	1,2,3	15-125	
	L	601-6000 (1,2,3P)	OPH, BOH, BLH	1,2,3	15-125	
100,000	T (300V)	15-200 (1,2,3P)	QP, BO, BL	1,2,3	15-125	
			HQP, HBQ, HBL, OPH, BOH, BLH	3	15-100	
			OPF, BOF, BLF, QHPF, QE, BE, BLE, QEH, BLEH, BLHF, BOHF, QAF, BAF, QAFH, BAFH	1	15-30	
			QEH, BLEH, QE, QPF, OPFH, BLHF, BLE, BLF, QAF, BAF, QAFH, BAFH	2	15-60	
			QT	1,2	15-50	
		15-600 (1,2,3P)	OPH, BOH, BLH, HQP, HBQ, HBL	1,2	15-125	
	J, R	15-600 (2,3P)	ED4, HED4	1	15-100	
			ED4, ED6, HED4, HED6	2,3	15-125	
			QAF2, BAF2, QAFH2, BAFH2, QFGA2, BFGA2, QFGAH2, BFGAH2	1	15-20	
			OPF2, BLF2, HQPF2, HBLF2, QPHF2, BLHF2	1	15-30	
			FD6-A, FXD6-A	2,3	70-250	
			70-600 (2,3P)	QR2, QRH2, HQR2	2,3	100-250
			100-600 (2,3P)	QR2, QRH2, HQR2	2,3	100-250
			200-600 (2,3P)	JD6-A, JXD6-A, JXD2-A, SJD6-A, SJD6-B	2,3	200-400
			300-600 (3P)	LD6-A	2,3	200-600
		450-600 (2,3P)	SLD6-A, SLD6-B	3	300-600	
T	15-1200 (2,3P)	ED4, HED4	1	15-100		
		ED4, ED6, HED4, HED6	2,3	15-125		
		QAF2, BAF2, QAFH2, BAFH2, HQAF2, HBAF2, QFGA2, BFGA2, QFGAH2, BFGAH2	1	15-20		
		OPF2, BLF2, HQPF2, HBLF2, QPHF2, BLHF2	1	15-30		
		FXD6-A, FD6-A	2,3	70-250		
		70-1200 (2,3P)	QR2, QRH2, HQR2	2,3	100-250	
		100-600 (2,3P)	QR2, QRH2, HQR2	2,3	100-250	
		450-1200 (2,3P)	LXD6-A	2,3	450-600	
		200-1200 (2,3P)	JD6-A, JXD6-A, JXD2-A	2,3	200-400	
		300-1200 (3P)	SJD6-A, SJD6-B	3	200-400	
L	601-6000 (2,3P)	LD6-A	2,3	200-600		
		LXD6-A	2,3	450-600		
		SLD6-A, SLD6-B	3	300-600		
		SMD6, SMD6-B	3	500-800		
		SND6, SND6-B	3	500-1200		
		PD6, PXD6, SPD6	3	1200-1600		
		RD6, RXD6	3	1600-2000		
		ED4, HED4	1	15-100		
		ED4, ED6, HED4, HED6	2,3			
		FD6-A, FXD6-A	2,3	70-250		
		JD6-A, JXD6-A, JXD2-A	2,3	200-400		
		SJD6-A, SJD6-B	3	200-400		
		LD6-A	2,3	200-600		
		LXD6-A	2,3	450-600		
		SLD6-A, SLD6-B	3	300-600		

## 240V Fuse Series Ratings (continued)

Series Rating kAIR	Main Fuse		Branch Breaker		
	Type	Max. Amperes	Type	Number of Poles	Max. Amperes
200,000	R	125-200 (2,3P)	QJH2, QJ2H, QJ2	2,3	125-200
			QJH2, QJ2H	2,3	125-225
			QJ2	2,3	125-225
	T, J	125-400 (2,3P)	QJ2	2,3	125-225
			QJ2	2,3	125-225
	J, R	70-600 (2,3P)	HFD6, HFXD6	2,3	70-250
			HFD6, HFXD6	2,3	70-250
	T	600-1200 (2,3P)	NMG, HMG	2,3	600-800
			NMG, HMG	2,3	600-800
	L	601-6000 (2,3P)	HFD6, HFXD6	2,3	70-250
			MD6, MXD6, HMD6, HMXD6	2,3	500-800
			NMG, HMG	2,3	600-800
			ND6, NXD6, HND6, HNXD6	2,3	500-1200
			ND6, NXD6, HND6, HNXD6	2,3	500-1200
	J,R	15-600 (1,2,3P)	NGB,HGB, LBG	1,2,3	15-125
NGB,HGB, LBG			1,2,3	15-125	
J,R	50-600 (2,3P)	NDGA, HDGA	2,3	50-150	
		NDGA, HDGA	2,3	50-150	
J,R	70-600 (2,3P)	NFGA, HFGA	2,3	70-250	
		NFGA, HFGA	2,3	70-250	
J,R	200-600 (2,3P)	NJGA, HJGA	2,3	200-400	
		NJGA, HJGA	2,3	200-400	
J,R	400,600 (1,2,3P)	NLGA, HLGA	2,3	400-600	
		NLGA, HLGA	2,3	400-600	
T	15-1200 (1,2,3P)	NGB,HGB, LBG	1,2,3	15-125	
		NGB,HGB, LBG	1,2,3	15-125	
T	50-1200 (2,3P)	NDGA, HDGA	2,3	50-150	
		NDGA, HDGA	2,3	50-150	
T	70-1200 (2,3P)	NFGA, HFGA	2,3	70-250	
		NFGA, HFGA	2,3	70-250	
T	200-1200 (2,3P)	NJGA, HJGA	2,3	200-400	
		NJGA, HJGA	2,3	200-400	
T	400-1200 (2,3P)	NLGA, HLGA	2,3	400-600	
		NLGA, HLGA	2,3	400-600	
L	601-6000 (2,3P)	NDGA, HDGA	2,3	50-150	
		NFGA, HFGA	2,3	70-250	
		NJGA, HJGA	2,3	200-400	
		NJGA, HJGA	2,3	200-400	
		NJGA, HLGA	2,3	400-600	

# Molded Case Circuit Breakers

## Series Connected Short Circuit Ratings

General

### 480V Fuse Series Ratings

Series Rating kAIR	Main Fuse		Branch Breaker			
	Type	Max. Amperes	Type	Number of Poles	Max. Amperes	
50,000	J	60-400 (1,2,3P)	ED4	1	60-100	
	J	15-400 (2,3P)	ED4	2,3	15-100	
	J	15-400 (1,2,3P)	ED4	1	15-50	
100,000	T, J	70-600 (2,3P)	FD6-A, FXD6-A	2,3	70-250	
	J, R	70-600 (2,3P)	HFD6, HFXD6	2,3	70-250	
	T, J, R	200-600 (2,3P)	JD6-A, JXD6-A	2,3	200-400	
			HJD6-A, HJX	2,3	200-600	
			LD6-A, HLD6	2,3	200-600	
	T	450-600 (2,3P)	LXD6-A, HLD6	2,3	450-600	
			HFD6, HFXD6	2,3	70-250	
			JD6-A, JXD6-A	2,3	200-400	
	T, L	601-1200 (2,3P)	HJD6-A, HJX	2,3	200-600	
			LD6-A, HLD6	2,3	200-600	
			LXD6-A, HLD6	2,3	450-600	
			HFD6, HFXD6	2,3	70-250	
	L	601-6000 (2,3P)	MD6, MXD6	2,3	500-800	
			HMD6, HMXD6	2,3	500-1200	
			ND6, NXD6	2,3	500-1200	
			HND6, HNXD6	2,3	500-1200	
			NDGA, HDGA	2,3	50-150	
			NFGA, HFGA	2,3	70-250	
			NJGA, HJGA	2,3	200-400	
			NLGA, HLGA	2,3	400-600	
			J,R	50-600 (2,3P)	NDGA, HDGA	2,3
J,R			70-600 (2,3P)	NFGA, HFGA	2,3	70-250
J,R	200-600 (2,3P)	NJGA, HJGA	2,3	200-400		
J,R	400-600 (2,3P)	NLGA, HLGA	2,3	400-600		
T	601-1200 (2,3P)	NDGA, HDGA	2,3	50-150		
T	601-1200 (2,3P)	NFGA, HFGA	2,3	70-250		
T	601-1200 (2,3P)	NJGA, HJGA	2,3	200-400		
T	601-1200 (2,3P)	NLGA, HLGA	2,3	400-600		
L	601-6000 (2,3P)	NDGA, HDGA	2,3	50-150		
		NFGA, HFGA	2,3	70-250		
		NJGA, HJGA	2,3	200-400		
		NLGA, HLGA	2,3	200-400		
		R	15-100 (1,2,3P)	BQD, CQD	1	15-100
		T, J	15-200 (1,2,3P)	BQD, CQD	2,3	20-30
				BQD, CQD	1	15-100
				BQD, CQD	2,3	20-30
				BQD, CQD	1	15-100

# Molded Case Circuit Breakers

IEC 947-2® AC Interrupting Ratings, 50/60 HZ KA

Reference

Ampere Rating	Breaker Frame	Breaker Type	220/240 Volts		380/415 Volts		500 Volts	
			Icu	Ics	Icu	Ics	Icu	Ics
15-125	ED	ED6	65	17	35	9	—	—
70-250	FD	FXD6	65	33	35	18	—	—
		HFXD6	100	50	65	33	—	—
		HHFXD6	200	100	100	50	—	—
250-400	JD	JXD6(A)	65	33	40	20	—	—
		HJXD6(A)	100	50	65	33	—	—
400-600	LD	LXD6(A)	65	33	40	20	—	—
		HLXD6(A)	100	50	65	33	—	—
600-800	MD	MXD6	65	33	40	20	—	—
		HMXD6	100	50	65	33	—	—
800-1200	ND	NXD6	65	33	40	20	—	—
		HNXD6	100	50	65	33	—	—

# Molded Case Circuit Breakers

## Typical Specifications

Reference

### General Specifications

Molded case circuit breakers shall provide circuit overcurrent protection with inverse time and instantaneous tripping characteristics and shall be Siemens Sentron, Sensitrip or approved equal.

All circuit breakers shall be listed by Underwriters' Laboratories, Inc., conform to applicable requirements of NEMA Standard Publication No. AB1 and meet appropriate classifications of Federal Specifications W C 375B/Gen.

All circuit breakers shall have a quick-make, quick-break over center toggle type mechanism and the handle mechanism shall be trip free to prevent holding contacts closed against a short circuit or sustained overload. All circuit breaker handles shall assume a position between "ON" and "OFF" when tripped automatically. Multi-pole circuit breakers shall be common-trip such that an overload or short circuit on any one pole will result in all poles opening simultaneously. Arc extinction is to be accomplished by magnetic arc chutes. All ratings are to be clearly visible. When reverse feed is indicated on the drawings, in accordance with UL, circuit breakers with sealed trip units shall be supplied.

### Thermal Magnetic Specifications

Unless otherwise noted on the drawings, all Circuit breakers 2000 Ampere and below shall have thermal-magnetic trip units, with inverse time-current characteristics. Automatic operation of these circuit breakers shall be obtained by means of thermal-magnetic tripping devices located in each pole providing inverse time delay and instantaneous circuit protection. Circuit breakers shall be ambient compensating in that, as the ambient temperature increases over 40°C, the circuit breaker automatically derates itself so as to better protect its associated conductor. Thermal magnetic breakers from 250 to 2000A frames shall have thermal interchangeable trip units, with instantaneous magnetic trip settings that are adjustable and accessible from the front of all circuit breakers on frame sizes 250 Amperes and above. Where indicated, provide circuit breakers UL listed for application at 100% of their continuous ampere rating in their intended enclosure.

### Motor Circuit Protectors

Where indicated on the drawings and in the combination motor starter/motor control center schedule, furnish instantaneous magnetic trip only circuit breakers for motor short circuit protection. The magnetic trips shall be adjustable and accessible from the front of all circuit breakers frames. The continuous current rating shall be between 1 and 800 Amperes as indicated on the drawing.

The interrupting rating of the circuit breakers shall be as indicated in the specifications, and shown on the drawing or single line diagram. The interrupting rating of the circuit breakers shall be at least equal to the available short circuit current at the line terminals of the circuit breaker and correspond to the UL listed integrated short circuit current rating specified.

### Internal Accessories

Provide shunt trips, bell alarms, and auxiliary switches as shown on the contract drawings. Gold plated auxiliary switches shall be supplied for PLC connection. Internal accessories for all breakers shall be UL listed for field installation and modification.

### Connection Accessories

Unless otherwise noted, Mechanical lugs shall be provided with all Molded Case Breakers. Where indicated on the drawings, compression lugs shall be provided on 1200 Ampere frame and below circuit breakers. All compression lugs shall be supplied by the Circuit Breaker Manufacturer. Where indicated on the drawings, UL listed plug-in or rear connectors shall be supplied.

### Solid State Sensing Specifications

As indicated on the drawings, circuit breaker frames 400 Ampere through 3200-Ampere shall have microprocessor-based RMS sensing trip units, with the capability to measure through to the 21st harmonic. Automatic operation of all circuit breaker frames 400A and larger shall be obtained by means of solid state tripping elements providing inverse time delay and (instantaneous) and/or (short-time delay) circuit protection. Continuous current ratings shall be adjustable from 20% to 100% of the trip unit rating, without the need for a rating plug. Long-time delay and instantaneous trip shall be adjustable. The optional short-time trip function shall have adjustable pick-up settings, three fixed times, and I<sup>2</sup>t ramp. Circuit breaker frames 400A and larger, and where indicated on the drawings, shall be 100% equipment rated.

### Integral Ground Fault Option

Main and feeder circuit breakers, as indicated on the drawings, shall be provided with integral ground fault protection. Ground fault pick-up shall be adjustable from 20% to 70% of the circuit breakers maximum continuous current rating. Ground fault time delay shall be adjustable with three I<sup>2</sup>t ramps.

### Metering Option

When indicated on the drawings, solid state trip breakers shall be furnished with a plug-in or panel mounted metering device. This device shall simultaneously display all three phase currents, as well as average current, ground current, and phase unbalance. In addition it shall display breaker status, a max log, and a trip log. The trip log will retain and display date, time and type of trip (overload, short circuit or ground fault) for the most recent 5 trip events.

### Current Limiting Specifications

Where indicated on the drawings, Siemens current limiting circuit breakers are to be furnished. Current limiting circuit breakers shall limit the let-through I<sup>2</sup>t to a value less than the I<sup>2</sup>t of one-half cycle wave of the symmetrical prospective current without any fusible elements when operating within its current range.

### Series Connected Combination Specifications

Where protective devices are applied in series combination, such that the prospective available fault current exceeds the interrupting rating (AIR) of the downstream protective devices, such combinations shall be UL recognized combinations. All electrical equipment using these UL recognized circuit breaker combinations shall be clearly marked in accordance with NEC Section 240-83(c).

# Molded Case Circuit Breakers

## Superseded Breakers

General

Sentron Series	Note	Superseded	Note	Superseded
CED62B015-CED62B125 CED62S100A CED63A001-CED63A125 CED63B015-CED63B125 CED63S100A HHED63B015-HHED63B125	① ① ① ① ① ①	CLE62B015-CLE62B100 CLE62S100 CLE63A001-CLE63A125 CLE63B015-CLE63B100 CLE63S100 HED63B015-HED63B125	③ ③ ③ ③	CE2B015-CE2B100 CE2S100  CE3B015-CEB100 CE3S100
CFD62A150, CFD62L150, CFD62A250 CFD62B070-CFD62B250 CFD62S250A CFD63A150, CFD63L150, CFD63A250 CFD63B070-CFD63B250 CFD63S250A	① ① ① ① ① ①	CLF62A150, CLF62A250 CLF62B070-CLF62B240 CLF62S250 CLF63A150, CLF63A250 CLF63B070-CLF63B250 CLF63S250	③ ③	CJ2B125-CJ2B250  CJ3B125-CJ3B250
CJD62B200-CJD62B400 CJD62H400, CJD62L400 CJD62S400A CJD63B200-CJD63B400 CJD63H400, CJD63L400 CJD63S400A	① ① ① ① ① ①	CLJ62B100-CLJ62B400 CLJ62L400, CLJ62H400 CLJ62S400 CLJ63B200-CLJ63B400 CLJ63L400, CLJ63H400 CLJ63S400	④ ④ ④ ④	CJ2B300-CJ2B400  CJ2S400 CJ3B300-CJ3B400  CJ3S400
CPD63B120-CPD63B160	⑤	CP3B120-CP3B160		
ED21B015-ED21B100 ED22B015-ED22B100 ED22S100A ED23B015-ED23B100 ED23S100A	① ① ① ① ①	E21B015-E21B100 E22B015-E22B100 E22S100A E23B015-E23B100 E23S100A	② ② ② ② ②	EE1B015-EE1B100 EE2B015-EE2B100 EE2S100 EE3B015-EE3B100 EE3S100
ED41B015-ED41B100 ED42B015-ED42B125 ED42S100A ED43B015-ED43B125 ED43S100A	① ① ① ① ①	E41B015-E41B100 E42B015-E42B100 E42S100 E43B015-E43B100 E43S100	② ② ② ② ②	EH1B015-EH1B100 EH2B015-ED2B125 EH2S100 EH3B015-EH3B100 EH3S100
ED61B015-ED61B100 ED62B015-ED62B125 ED62S100A ED63A001-ED63A125 ED63B015-ED63B125 ED63S100A HHED63B015-HHED63B125	① ① ① ① ① ① ①	E61B015-E61B100 E62B015-E62B100 E62S100A E63A001-E63A125 E63B015-E63B100 E63S100A HED63B015-HED63B125	② ② ② ② ② ② ②	EF1B015-EF1B020 EF2B015-EF2B100 EF2S100 EF3A003, EF3J050, EF3L050-EF3A100, EF3H1 EF3B015-EF3B100 EF3S100
FD62B070-FD62B250 <sup>⑥</sup> FD63B070-FD63B250 <sup>⑥</sup>	① ①	F62B070, F62B250 F63B070-F63B250		
FXD62A150, FXD62L150, FXD62A250 FXD62B070-FXD62B250 <sup>⑥</sup> FXD62S250A FXD63A150, FXD63L150, FXD63A250 FXD63B070-FXD63B250 <sup>⑥</sup> FXD63S250A	① ① ① ① ① ①	FJ62A150, FJ62L150-FJ62A250 FJ62B070-FJ62B250 FJ62S250 FJ63A150, FJ63L150-FJ63A250 FJ63B070-FJ63B250 FJ63S250	② ② ② ② ② ②	FJ2B070-FJ2B225 FJ2S225 FJ3A225 FJ3B070-FJ3B225 FJ3S225
HED41B015-HED41B100 HED42B015-HED42B125 HED43B015-HED43B125	① ① ①	HE41B015-HE41B100 HE42B015-HE42B100 HE43B015-HE43B100		
HED61B015-HED61B100  HED63B015-HED63B125	①  ①	HE61B015-HE61B100  HE63B015-HE63B100	② ②	HE2B015-HE2B100 HE3B015-HE3B100
HFD62B070-HFD62B250 HFD63B070-HFD63B250	① ①	HF62B070-HF62B250 HF63B070-HF63B250		
HHED63B015-HHED63B125	①	HED63B015-HED63B125		
HJD63B200-HJD63B400	①	HJ63B200-HJ63B400	②	HJ3B125-HJ3B400
HLD63B250-HLD63B600	①	HL63B450-HL63B600	②	HL3B450-HL3B600
HMD63B500-HMD63B800	②	HN3B500-HN3B800		
HND63B100-HND63B120	②	HK3B100-HK3B120		
HPD63B120-HPD63B160	②	HP3B120-HP3B160		
HRD63B160-HRD63B200	②	HR3B160-HR3B200		

① Mechanically and electrically interchangeable.

② Electrically interchangeable only, refer to sales office for further details.

③ Electrically interchangeable only if the system interrupting capacity is less than or equal to:  
200 kA at 240V AC  
200 kA at 480V AC  
100 kA at 600V AC

④ Electrically interchangeable only if the system interrupting capacity is less than or equal to:

200 kA at 240V AC  
150 kA at 480V AC  
100 kA at 600V AC

⑤ Refer to local sales office for replacement information.

⑥ Effective 1994 — The FD6 and FXD6 types have been replaced by FD6-A and FXD6-A type thermal / magnetic circuit breakers — mechanically and electrically interchangeable with the exception that FXD6-A and FD6-A have 22kA at 600V AC ratings versus 18kA at 600V AC for types FXD6 and FD6.

# Molded Case Circuit Breakers

## Superseded Breakers

General

Sentron Series	Note	Superseded	Note	Superseded
JD62B200-JD62B400	①	JLB200-JL62B400	②	JL2B070-JL2B400
JD63B200-JD63B400	①	JL63B200-JL63B400	②	JL3B0L0-JL3B400
JXD22B200-JXD22B400	①	JD22B200-JD22B400	②	JD2B250-JD2B400
JXD22S400A	①	JD22S400	②	JD2S400
JXD23B200-JXD23B400	①	JD23B200-JD23B400	②	JD3B250-JD3B400
JXD23S400A	①	JD23S400	②	JD3S400
JXD62B200-JXD62B400	①	JJ62B200-JJ62B400	②	JJ2B250-JJ2B400
JXD62H400, JXD62L400	①	JL62L400, JL62H400	②	JL2L400-JL2H400
JXD62S400A	①	JJ62S400A		
JXD63B200-JXD63B400	①	JJ63B200-JJ63B400	②	JJ3B200-JJ3B400
JXD63H400, JXD63L400	①	JL63A400, JL63H400, JL63L400	②	JL3H400, JL3L400, JL3A225
JXD63S400A	①	JJ63S400A		
LD62B250-LD62B500	①	LL63B250-LL62B600	②	LL2B450-LL2B600
LD62B250-LD63B600	①	LL63B250-LL63B600	②	LL3B450-LL3B600
LXD62B450-LXD62B600	①	LJ62B450-LJ62B600		
LXD62J600, LXD62L600	②	LL2H600, LL2U600, LL2X600		
LXD62S600A	①	LJ62S600		
LXD63B450-LXD63B600	①	LJ63B450-LJ63B600		
LXD64H600, LXD63L600	①	LL63H600, LL63L600	②	LL3A450, LL3H600
LXD63S600A	①	LJ63S600A	②	LL3S600
MD62B500-MD62B800	②	KM2B500-KM2B800		
MD63B500-MD63B800	②	KM3B500-KM3B800		
MXD62A800, MXD62H800, MXD62L800	②	KM2A800, KM2H800, KM2L800		
MXD62S800A	②	KM2S800		
MXD63A800, MXD63H800, MXD63L800	②	KM3A600, KM3H800, KM3L800		
MXD63S800A	②	KM3S800		
ND63B100-ND63B900	②	KP3B100-KP3B900		
NXD63S120A	②	KP3S120		
PD63B120-PD63B160	②	HP3B120-HP3B160		
PXD63S160A	②	HP3S160		
RD63B160-RD63B200	②	HR3B160-HR3B200		
QR22B100 – QR22B225		QJ22B060-QJ22B225		
QR22B100H – QR22B225H		QJ22B060H-QJ22B225H		
HQR23S250HA		QJ22S225		
QJ23B100 – QR23B225		QJ23B060-QJ23B225		
QR23B100H – QR23B225H		QJ23B060H-QJ23B225H		
QRH22B100 – QRH22B225		QJH22B060-QJH22B225		
QRH23B100 – QRH23B225		QJH23B060-QJH23B225		
HQR23S250HA		QJH23S225	①	
QJH22B060-QJH22B225	①	QJ2H125-QJ2B225		
QJH23B060-QJH23B225	①	QJ3H125-QJ3H225		
QJH23S225	①	QJ3S225		
RD63B160-RD63B200	②	HR3B160-HR3B200		
RXD63S200A	②	HR3S200		
SCJD6B200LI-SCJD6B400LI	①	SCJD69200-SCJD69400		
SCJD6B200LIG-SCJD6B400LIG	①	SCJD69200G-SCJD69400G		
SCJD6B200LSIG-SCJD6B400LSIG	①	SCJD69200NGT-SCJD69400NGT		
SCJD6B200LSI-SCJD6B400LSI	①	SCJD69200NT-SCJD69400NT		
SCLD6B300LI-SCLD6B600LI	①	SCLD69300-SCLD69600		
SCLD6B300LIG-SCLD6B600LIG	①	SCLD69300G-SCLD69600G		
SCLD6B300LSIG-SCLD6B600LSIG	①	SCLD69300NGT-SCLD69600NGT		
SCLD6B300LSI-SCLD6B600LSI	①	SCLD69300NT-SCLD69600NT		
SCMD6B600LI-SCMD6B800LI	①	SCMD69600A-SCMD69800A		
SCMD6B600LIG-SCMD6B800LIG	①	SCMD69600AG-SCMD69800AG		
SCMD6B600LSIG-SCMD6B800LSIG	①	SCMD69600ANGT-SCMD69800ANGT		
SCMD6B600LSI-SCMD6B800LSI	①	SCMD69600ANT-SCMD69800ANT		

①Mechanically and electrically interchangeable.

②Electrically interchangeable only, refer to sales office for further details.

③Electrically interchangeable only if the system interrupting capacity is less than or equal to:  
200 kA at 240V AC  
200 kA at 480V AC  
100 kA at 600V AC④Electrically interchangeable only if the system interrupting capacity is less than or equal to:  
200 kA at 240V AC  
150 kA at 480V AC  
100 kA at 600V AC

⑤Refer to local sales office for replacement information.

# Molded Case Circuit Breakers

## Superseded Breakers

General

Sentron Series	Note	Superseded	Note	Superseded
SCND6B800LI-SCND6B120LI	①	SCND69800A-SCND69120A		
SCND6B800LIG-SCND6B120LIG	①	SCND69800AG-SCND69120AG		
SCND6B800LSIG-SCND6B120LSIG	①	SCND69800ANGT-SCND69120ANGT		
SCND6B800LSI-SCND6B120LSI	①	SCND69800ANT-SCND69120ANT		
SHJD6B200LI-SHJD6B400LI	①	SHJD69200-SHJD69400	①	SHJ63B200-SHJ63B400G
SHJD6B200LIG-SHJD6B400LIG	①	SHJD69200G-SHJD69400G	①	SHJ63B200G-SHJ63B400G
SHJD6B200LSIG-SHJD6B400LSIG	①	SHJD69200NGT-SHJD69400NGT	①	SHJ63N200G-SHJ63N400G
SHJD6B200LSI-SHJD6B400LSI	①	SHJD69200NT-SHJD69400NT	①	SHJ63N200-SHJ63N400
SHLD6B300LI-SHLD6B600LI	①	SHLD69300-SHLD69600	①	SHL63B300-SHL63B600
SHLD6B300LIG-SHLD6B600LIG	①	SHLD69300G-SHLD69600G	①	SHL63B300G-SHL63B600G
SHLD6B300LSIG-SHLD6B600LSIG	①	SHLD69300NGT-SHLD69600NG	①	SHL63N300G-SHL63N600G
SHLD6B300LSI-SHLD6B600LSI	①	SHLD69300NT-SHLD69600NT	①	SHL63N300-SHL63N600
SHND6B100LI-SHND6B120LI	①	SHND69100A-SHND69120A	①	SHND69100-SHND69800
SHND6B100LIG-SHND6B120LIG	①	SHND69100AG-SHND69120AG	①	SHND69100G-SHND69800G
SHPD6B140LI-SHPD6B160LI	①	SHPD69140-SHPD69160	②	SHPF3B120-SHPF3B160
SHPD6B140LIG-SHPD6B160LIG	①	SHPD69140G-SHPD69160G	②	SHPF3B120G-SHPF3B160G
SHND6B100LSIG-SHND6B120LSIG	①	SHND69100NGT-SHND69800NGT	①	SHKF3N100G-SHKF3N800G
SHND6B100LSI-SHND6B120LSI	①	SHND69100NT-SHND69800NT	②	SHKF3N100-SHKF3N800
SJD6B200LI-SJD6B400LI	①	SJD69200-SJD69400	①	SJL63B200-SJL63B400
SJD6B200LIG-SJD6B400LIG	①	SJD69200G-SJD69400G	①	SJL63B200G-SJL63B400G
SJD6B200LSIG-SJD6B400LSIG	①	SJD69200NGT-SJD69400NGT	①	SJL63N200G-SJL63N400G
SJD6B200LSI-SJD6B400LSI	①	SJD69200NT-SJD69400NT	①	SJL63N200-SJL63N400
SLD6B300LI-SLD6B600LI	①	SLD69300-SLD69600	①	SLL63B300-SLL63B600
SLD6B300LIG-SLD6B600LIG	①	SLD69300G-SLD69600G	①	SLL63B300G-SLL63B600G
SLD6B300LSIG-SLD6B600LSIG	①	SLD69300NGT-SLD69600NGT	①	SLL63N300G-SLL63N600G
SLD6B300LSI-SLD6B600LSI	①	SLD69300NT-SLD69600NT	①	SLL63N300-SLL63N600
SMD6B600LI-SMD6B800LI	①	SMD69600A-SMD69800A	①	SMD69600-SMD69800
SMD6B600LIG-SMD6B800LIG	①	SMD69600AG-SMD69800AG	①	SMD69600G-SMD69800G
SMD6B600LSIG-SMD6B800LSIG	①	SMD69600ANGT-SMD69800ANGT	①	SMD69600NGT-SMD69800NGT
SMD6B600LSI-SMD6B800LSI	①	SMD69600ANT-SMD69800ANT	①	SMD69600NT-SMD69800NT
SND6B800LI-SND6B120LI	①	SND69800A-SND69120A	①	SND69100-SND69800
SND6B800LIG-SND6B120LIG	①	SND69800AG-SND69120AG	①	SND69100G-SND69800G
SND6B800LSIG-SND6B120LSIG	①	SND69800ANGT-SND69120ANGT	①	SND69100NGT-SND69800NGT
SND6B800LSI-SND6B120LSI	①	SND69800ANT-SND69120ANT	①	SND69100NT-SND69800NT
SHPD6B140LI-SHPD6B160LI	①	SPD69140-SPD69160	②	SHPF3B120-SHPF3B160
SHPD6B140LIG-SHPD6B160LIG	①	SPD69140G-SPD69160G	②	SHPF3B120G-SHPF3B160G
SHPD6B140LSIG-SHPD6B160LSIG	①	SPD69140NGT-SPD69160NGT	②	SHPF3N120-SHPF3N160G
SHPD6B140LSI-SHPD6B160LSI	①	SPD69140NT-SPD69160NT	②	SHPF3N120G-SHPF3N160G
—	④	BQCC1B015-BQC1B030		
—	④	CC1B015-CC1B030		
—	④	CC2B015-CC2B030		
—	④	CC3B015-CC3B030		
—	④	EF2A003, EF2H050, EF2L050, EF2A100		
—	④	EF2H150, EF2L150		
—	④	EH1B015-EH1B100		
—	④	EH2B015-EH2B100		
—	④	EH3B015-EH3B100		
—	③	HE2A003, HE2H050, HE2L050-HE2A100		
—	③	HE3A003, HE3H050, HE3L050-HE3A100		
—	③	HE3B015-HE3B100		

7  
MOLDED CASE  
CIRCUIT BREAKERS

①Mechanically and electrically interchangeable.  
 ②Electrically interchangeable only, refer to sales office for further details.  
 ③These units are for replacement purposes only. Consult sales office for availability.

④These units are no longer manufactured, and no replacement is available.

# Molded Case Circuit Breakers

Notes

7

MOLDED CASE  
CIRCUIT BREAKERS



# Renewable Energy Products

## VersiCharge EVSE and Accessories

### Flexible Install Options

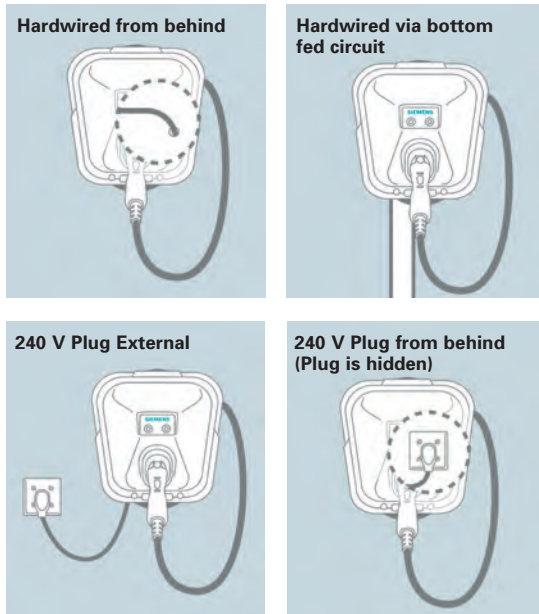

### Electric Vehicle Supply Equipment

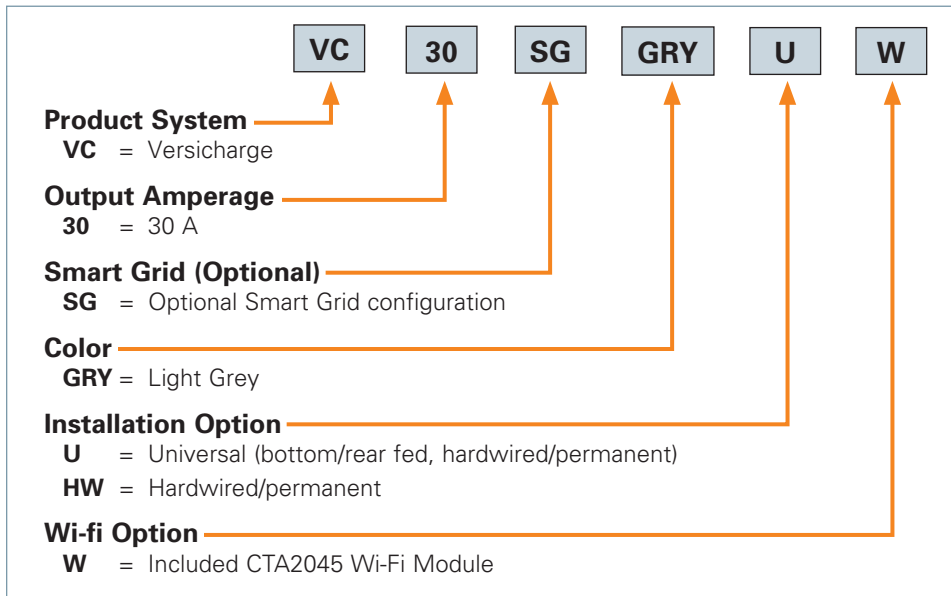

### VersiCharge electric vehicle chargers

Part number	Model	Output amperage	Color	Feeder Location
VC30GRYU	Universal VersiCharge	30A	Grey	Rear/Bottom/Hardwired
VC30GRYHW	Hardwired VersiCharge	30A	Grey	Hardwired
VCSG30GRYUW	Wi-Fi VersiCharge	30A	Grey	Rear/Bottom/Hardwired

### Accessories

Part number	Description	Color
VCMNTGBRK	Spare parts mounting bracket	Black
VCPOSTGRY	Outdoor mounting post	Grey

# Renewable Energy Products

## VersiCharge Technical Features

### Technical Features

	Attribute	Hardwired Model	Universal Model	Wi-Fi Model with option to customize module	Wi-Fi Model with included module
Essentials	Part Number	VC30GRYHW	VC30GRYU	VCSG30GRYU	VCSG30GRYUW
	Input voltage	208 - 240 VAC			
	Output Amperage	30 Amps			
	Output power	1.8 kW to 7.2 kW			
	Standby Power	Less than 6 Watts	Less than 9 Watts		
	Cord length	14 ft.	20 ft.		
	Wall weight	12.5 lbs.	14.5 lbs.		
	Dimensions	14.5"W x 16.0"H x 6.5"D			
	Enclosure	NEMA 1	NEMA 4		
	Plug in installation	No	Yes (below or behind unit)		
	Permanent installation	Yes			
	Communication hardware		N/A	CTA2045 Interface without communication module	CTA2045 Interface with communication module
	Network connection		N/A	Optional	Wi-Fi
	Radio		N/A	Optional	High Performing 2.4 GHz IEEE 802.11 b/g/n
	Connectivity		N/A	Communicated to vendor specific cloud	Communicated through local wireless network to VersiCharge SG Cloud
	Metering accuracy		N/A	+/- 0.5% standard (custom precision variant available)	
	Reporting parameters		N/A	Power consumption, status, events	
Demand response compatible		Yes, with accessory	Yes, with appropriate communications module	Yes, with Opt-in	
Electrical	Circuit requirement	40 Amperes*		40 Amperes**	
	Infrastructure Plug	NEMA 6-50			
	Input power connections	Line 1, Line 2, Earth Ground			
	Recommended branch break	40 Ampere double pole (Siemens: Q240 plug in type, B240 bolt on type)			
Mechanical Safety and Operational	Connector	SAE J1772			
	Standards compliance	UL, SAE J1772, NEC® 625			
	EMC	FCC Part 15 Class B			
	Operating temperature	-30°C to +50°C			
	Storage temperature	-40°C to +60°C			
	Operating humidity	Maximum 95% non-condensing			
	Ground fault detection	5 mA CCID with auto retry			
Electric Vehicles Tested	Vehicles	BMW i3, BMW i8, Ford Focus Electric, Nissan Leaf, Mercedes B Class, Fiat 500e, GM Volt			

### Wall Mounted EVSE

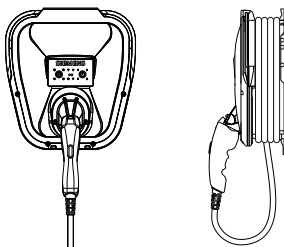

14.5" W x 16.0" H x 6.5" D  
(front of unit excluding connector)  
15" minimum clearance recommended for connector when inserted.

### Mounting Bracket

included with every Siemens VersiCharge



2.5" x 16.9"  
Install at a minimum of 18"  
off the ground

### Outdoor Mounting Post

tamper resistant hardware kit included

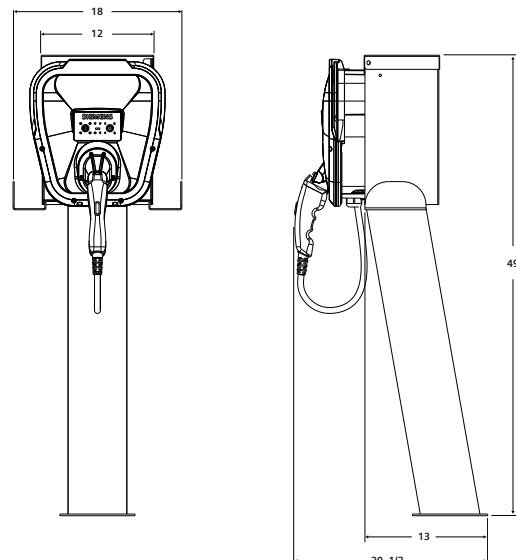

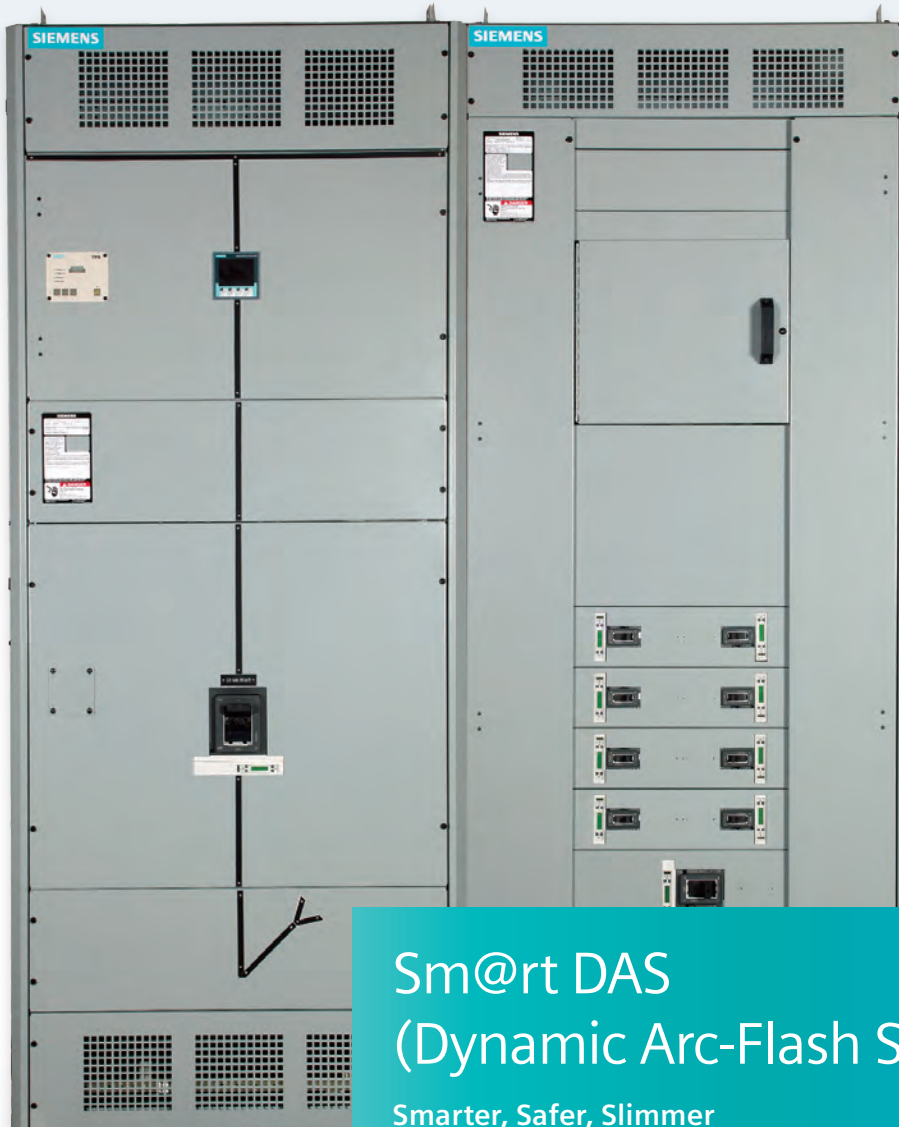

## Sm@rt DAS (Dynamic Arc-Flash Sentry)

Smarter, Safer, Slimmer

- Can be used in most equipment including Switchgear, Switchboards and Power Panels
- Scalable solution to add multiple breakers, including power circuit breakers, insulated case circuit breakers and molded case circuit breakers in a single system
- Automatically toggle between nominal trip settings and maintenance mode
- Complies with NEC 240.87

## SPEEDFAX 2017 Product Catalog

Siemens Industry, Inc.  
5400 Triangle Parkway  
Norcross, GA 30092

1-800-241-4453  
info.us@siemens.com

**Order No.: PDPC-01000-0217**

Printed in USA  
© 2017 Siemens Industry, Inc.  
All rights reserved

Subject to changes and errors. The information given in this document only contains general descriptions and/or performance features which may not always specifically reflect those described, or which may undergo modification in the course of further development of the products. The requested performance features are binding only when they are expressly agreed upon in the concluded contract.

[www.usa.siemens.com/powerdistribution](http://www.usa.siemens.com/powerdistribution)

