

front mounted rotary operator standard IEC IP30/40 accessory for:
3VA2 100/160/250



Model

Product brand name	SETRON
Product designation	Accessories
Product version	Front rotary operating mechanism

General technical data

Protection class IP	IP30
---------------------	------

Mechanical Design

Height	82 mm
Width	105 mm
Depth	106 mm
Net weight	301 g

Certificates

General Product Approval	EMC	Declaration of Conformity	Shipping Approval	other
Miscellaneous 	 RCM	 EG-Konf.	 LRS	Manufacturer Declaration

other
Miscellaneous

Further information

Information- and Downloadcenter (Catalogs, Brochures,...)

<http://www.siemens.com/lowvoltage/catalogs>

Industry Mall (Online ordering system)

<https://mall.industry.siemens.com/mall/en/en/Catalog/product?mlfb=3VA9267-0EK11>

Service&Support (Manuals, Certificates, Characteristics, FAQs,...)

<https://support.industry.siemens.com/cs/ww/en/ps/3VA9267-0EK11>

Image database (product images, 2D dimension drawings, 3D models, device circuit diagrams, ...)

http://www.automation.siemens.com/bilddb/cax_en.aspx?mlfb=3VA9267-0EK11

CAX-Online-Generator

<http://www.siemens.com/cax>

Tender specifications

<http://www.siemens.com/specifications>

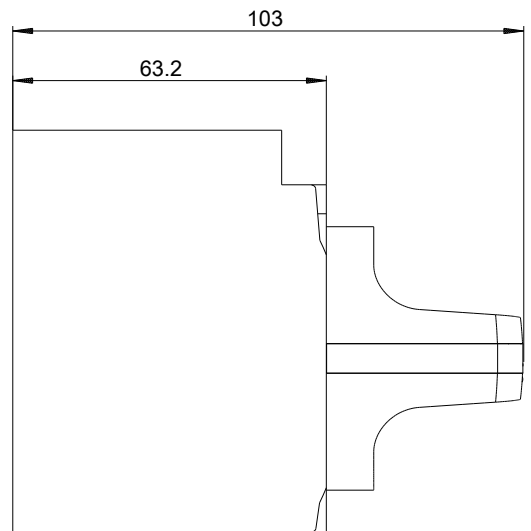
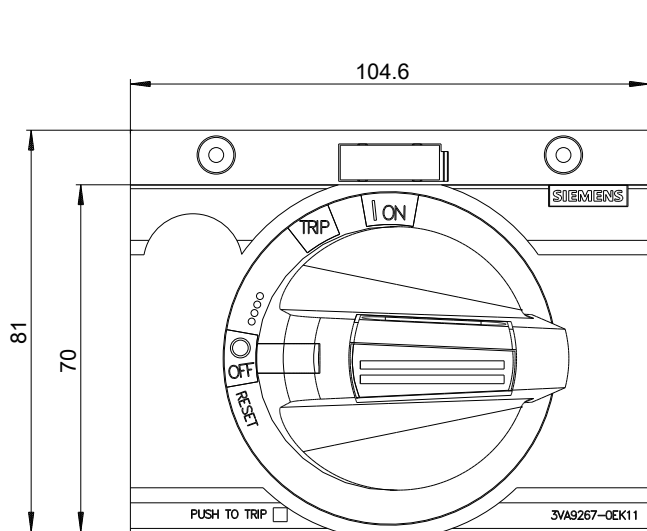

last modified:

03/19/2020