CATALOG

Color-Keyed®

Compression connectors



Thomas & Betts is now ABB Installation Products, but our long legacy of quality products and innovation remains the same. From connectors that help wire buildings on Earth to cable ties that help put machines in space, we continue to work every day to make, market, design and sell products that provide a smarter, safer and more reliable flow of electricity, from source to socket.

Table of contents

004–013	Overview
014–052	Compression connectors for copper conductor
053–054	C-tap connectors for copper conductor
055–056	Copper H-tap connectors for copper conductor
057	Aluminum H-tap connectors
058–060	Interlocking insulating covers for compression taps
061	Wire joints for copper conductor
062	Cast copper bus taps for copper conductor
063–068	Motor pigtail connectors
069–072	KUBE® connectors
073–074	Copper disconnects
075–076	Connector kits
077–078	Joint compound
079–090	Connectors for aluminum / copper code conductor
091–097	Heavy-duty battery connectors
098–101	Metric connectors for copper conductor
102–133	Tools and dies

Overview

The Thomas & Betts method is better

The Thomas & Betts method of installing compression connectors on power cables is designed to provide a high degree of reliability in electrical wiring.

This method allows electrical workers to make installations with little effort and at a considerable savings in time. The benefit, of course, is a high-quality connection at a low installed cost.

Blackburn® Connectors featuring the Color-Keyed® system are banded by colored stripes or engraving to indicate location of die on connector for compression. Thomas & Betts uses full-width and half-width dies dependent on connector size

and tool used. Half-width dies are marked with the letter “H” after the die code number. Refer to the instruction sheet supplied with the connectors for information regarding strip length, die selection and number of compressions required.

Just four easy steps to a perfect connection!



—
01

—
01 Strip the insulation
—
02 Stripping types and conductor connections

Step 1

Carefully strip the insulation on de-energized wires to avoid nicking or cutting conductors (wire brush if required).

Stripping types:

- **A** – Strand cut
- **B** – Nicked strands
- **C** – Good strip

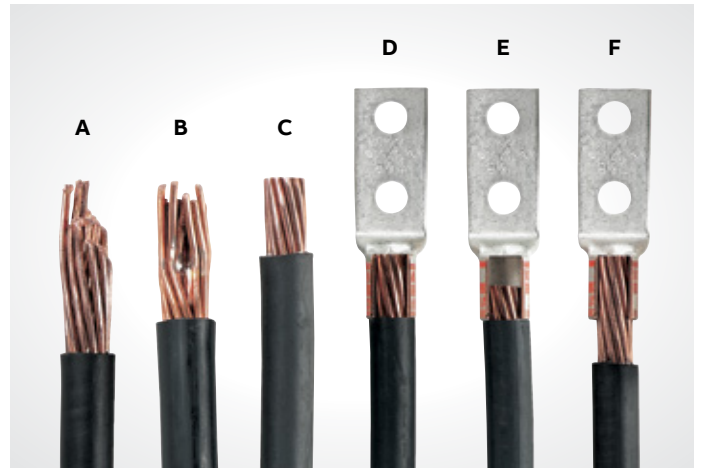

—
02

Strip the insulation to the proper length so that conductors can be fully inserted into the connector barrel.

Conductor connections:

- **D** – Strip length too long
- **E** – Strip length too short
- **F** – Strip length just right



03

- * Aluminum lugs with a "9" indicate 90 °C rating
- 03 Select the connector for the cable size
- 04 Connector types and markings

Step 2

Determine the proper Blackburn Connector for the cable size being used. Connectors are marked to show cable size and material:

- **G** – Cable size
- **H** – Copper (die located BETWEEN bands)
- **I** – Aluminum (die located ON bands)

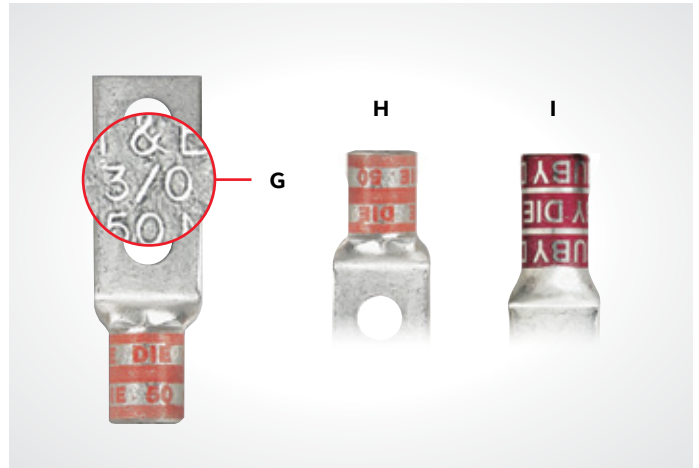

04

Connector types:

- Connectors marked with just cable size or CU should be used on copper conductors only
- Connectors marked "AL9"* with the cable size should be used on aluminum conductors only
- Connectors marked "AL9CU" with the cable size may be used on the aluminum or copper conductors



05

- 05 Select the installing die
- 06 Color-Keyed bands and die location for compression

Step 3

Select the proper installing die and appropriate tool. Blackburn Connectors featuring the Color-Keyed system have colored bands or colored dots that correspond to color markings on the dies.

Connectors and dies also have a die code number marked or stamped on them. Dies have a code number engraved in the crimp surface.

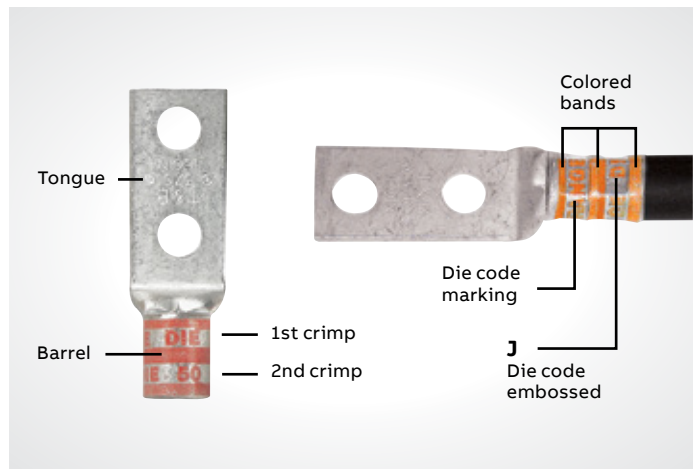

06

Step 4

Locate tool with correct die in proper position on connector and activate tool. When making multiple crimps, make the first crimp nearest the tongue and work towards the barrel end.

When properly crimped, the die code number will be embossed on the connector for easy inspection to determine if correct die and connector combination were used (J).

Overview

Precision dies

The T&B method utilizing compression tools with matching dies forms the connector and conductor into a solid, homogenous mass to provide an optimum electrical bond between connector and conductor.

—
01 Locate tool with correct die in proper position on connector and activate tool.

—
02 Before compression, a typical cross section of cable and connector consists of about 75% metal and 25% air.

—
03 After air compression by the T&B Method, the cross section looks like this, nearly 100% metal with virtually no air spaces.

Thomas & Betts method dies are designed to produce a circumferential, hex- or diamond-shaped compression rather than a simple indent. Precision dies are an integral part of the Thomas & Betts method. The precision hardened steel dies exert tremendous, controlled pressure on the connector and conductor. The dies compress the connector around the cable, converting the round strands to hexagonal or diamond shapes and forming the strands and connector into a solid mass. Each die is designed so that all conductors receive the same amount of compression force.

The circumferential compression creates a large area of high-pressure contact between cable and connector which, in turn, assures high conductivity, low resistance, and high pullout values which exceed UL requirements. These features result in a permanent, low installed cost connection. You can install it, and forget it.

The Thomas & Betts system tells you where to place the installing die

Blackburn® connectors featuring the Color-Keyed® system not only identify the correct installing die to be used for positive compressions, but also indicate the proper placement of the die on the connector. This is done by the bands of color on the connector which match the color on the dies. Compression is made between or on these color bands. The color name is also spelled on the connector as an added means of identification.

Thomas & Betts dies offer inspection capability

Dies that are used in Thomas & Betts hand and hydraulic tools contain the “die code” numbers which are engraved on the compression surface of the die. Under compression, this number becomes embossed on the completed connection for inspection purposes. The inspector compares the die code number embossed on the connector with the die table to ensure that the proper connector was compressed with the correct die for that particular size conductor.



02

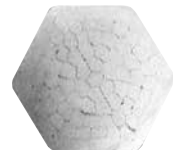

03



Battpac® LT Pump
350 kcmil AL. The newest battery-powered hydraulic pump, rated for 10,000 psi. Portable power for all T&B hydraulic heads, using just one Ni-MH 24V rechargeable battery.



TBM62BSCR
Single-handed battery powered compression tool, features rotating head and comfortable balance. For connectors up to 500 kcmil Cu 350 kcmil AL.



TBM65 Hand-operated crimping tool features Shure-Stake mechanism to ensure a completed crimp. For connectors up to 500 kcmil Cu, 350 kcmil AL.



Quality Tooling with the Shure-Stake® Mechanism

T&B manual tools with the exclusive Shure-Stake mechanism take the guesswork out of making compression connections. The Shure-Stake mechanism provides a full cycle compression stroke every time. Once the stroke has started, the tool will not release the connector until the proper amount of force has been applied. This is your assurance of a fully compressed connection. T&B compression tools develop uniform, controlled pressure to each connector within their size range. Thomas & Betts offers electric and battery-powered hydraulic pumps with a Shure-Stake feature that guarantees a full cycle compression.

Thomas & Betts method components meet industry standards

Depending on the application, all Thomas & Betts copper connectors meet UL Std. 486A for code stranded and 24 gauge flex, CSA Std. C22.2, No. 65 600 V requirements for power and UL Std. 467, CSA Std. 22.2 No. 0.4 requirements for direct buried grounding.

T&B method connectors are available in a range of sizes and styles to accommodate #8 AWG through 1000 kcmil and larger copper or 2000 kcmil and larger aluminum cable. They may be compressed on cable with either manual or hydraulic tools. They are offered with standard length or long barrels, with one bolt or two bolt holes, or in two-way

styles, for splicing applications. Two-way connectors are compact, providing high pullout values with low resistance.

Blackburn two-hole lugs featuring the Color-Keyed system are ideal for bus bar applications that require two bolts to prevent lug rotation. The T&B method is the most efficient, highest quality connection that has been engineered and delivers the best electrical performance and highest reliability.

T&B Compression Connectors eliminate risk of problems relating to loose connections when installed properly.

High-grade materials incorporated in Thomas & Betts method

Low installed cost connections of superior quality can be achieved only through the use of high-grade components. That is an important part of the T&B method – quality products you can depend on.

Copper Blackburn connectors featuring the Color-Keyed system are made of high-conductivity wrought copper, and are electro-tin plated to prevent corrosion and to improve conductivity. Thomas & Betts Blackburn connectors featuring the Color-Keyed system offer the thickest tin plating in the industry. Other copper connectors for heavy-duty use and grid grounding applications are made of high-conductivity cast copper, bright finished.

High-conductivity cast aluminum connectors are available for heavy-duty application.

Overview

Special lugs – Angled, shaped & trimmed

Thomas & Betts can solve your difficult wire bending and terminating problems in confined power distribution panels, switchgear and motor control enclosures.



—
01 Special lugs – Angled, shaped & trimmed

—
02 Examples of customized connectors for copper cables

We have the design and production capability to deliver exactly the type lug you need, shaped the way you need:

- Straight, 15°, 30°, 45°, 60° and 90° angle
- Stacking or non-stacking
- Narrow tongue or standard
- Tin, silver, lead, nickel

Thomas & Betts offers an extensive line of copper Blackburn® lugs featuring the Color-Keyed® system for #8 AWG through 1000 kcmil flex and code cables. The lug tongues are modified in several different configurations to meet your exact needs: 45° and 90° bend angles, narrow tongues to fit into circuit breakers, offset tongues to stack two cables and special stud hole drilling.

These special configurations let you:

- 1) Run cable directly to the bus bar with no bending.
- 2) Terminate into very narrow spaces.
- 3) Utilize minimal bus bar space.

Customized connectors for copper cables

- Standard and special tongue angles, stacking and nonstacking, bolt holes sizes and centers, protective platings.
- Specially modified one- and two-hole copper compression lugs, Series 54100, 54200, 54850BE and 54930BE for flex and code copper stranded cables. Material: High conductivity wrought copper.
- Minimum order quantity: Standard package quantity by cable size. Consult factory for price and delivery. All customized lugs are made to order. A.R.O. Non-cancelable.

—
01



—
02



Overview

Order form

Order form (For 54100, 54200, 54800 & 54900 Series copper lugs only):

Catalog number: **Quantity:**

Notes:

Notes:
 1) Lack of any of the extra features on the "MADE-UP" catalog number means that the standard Cat. No. features are prevalent.
 2) If either bolt hole size or distance between bolt holes needs to be changed from standard Cat. No., both code numbers will appear on the "MADE-UP" Cat. No. (See example below)

Cable:

Code: **Weld:**

#8 #6 #4 #2 #1 1/0 2/0 3/0 4/0

250 kcmil & up (code only)

All "made-up" catalog numbers start with a standard or basic catalog number and are followed by the customer-required extra features: tongue shape, bolt hole size, distance between bolt holes, stacking, plating and inspection hole (peep hole). A code letter or a number has been assigned to each extra feature. See code table.

Code table

Tongue shape		Bolt holes		Bolt hole centers		Stacking		Finish (plating)		Inspection hole (long barrel)		Inspection hole (short barrel)	
Type	Code	Size	Code	Distance	Code	Type	Code	Type 1	Code	I.D.	Code	I.D.	Code
		0.020 (in.)		0.015 (in.)									
15°	UI	#8 0.173	02	½	08	Top	T**	Silver plate	SP	Peep hole	PH	Blind end	BE
30°	UT	#10 0.204	03	⅝	10	Bottom	B	Lead plate	LP				
45°	UF	¼ 0.281	04	¾	12			Nickel plate	NP				
60°	US	⅝ 0.344	05	⅞	14			Plain finish	PF				
90°	UB	¾ 0.406	06	1	16			No marking	NM				
Blank	BT	½ 0.531	08	1⅝	18			Not QTP if					
(No bolt hole)		⅝ 0.656	10	1¾	20			suffix other					
		¾ 0.812	12	1⅞	22			than -pf					
		⅞ 0.937	14	1½	24			or standard					
		1 1.062	16	1⅞	26			tin plate					
				1¾	28								
				1⅞*	30								
				2*	32								

Diagrams

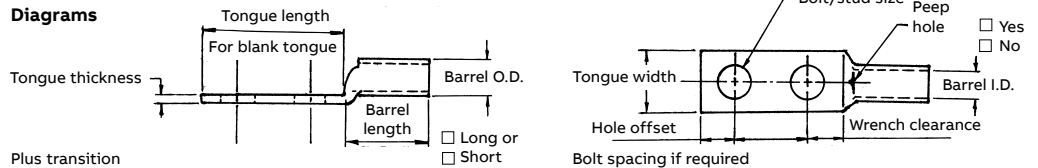

* These bolt centers not available for bolt holes larger than 1⅝".
 ** Not required for 45° & 90° top stacking.

Catalog number selection

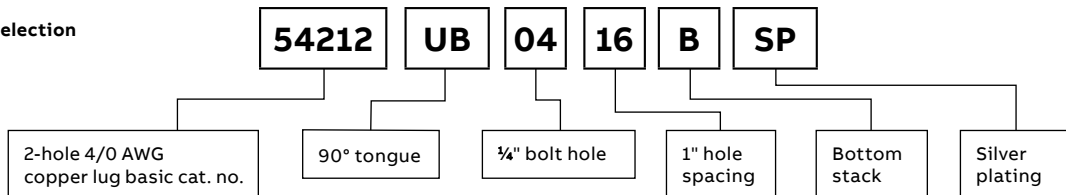

SUSTAINABLE DEVELOPMENT

Innovation, operational excellence and sustainable development are central to everything we do, reducing our environmental footprint and improving our communities.





Overview

Tongue specifications (see chart “A” for dimensions)

Chart A

Stud sizes:

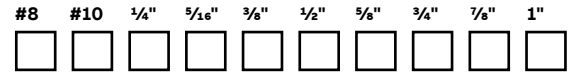

Nominal bolt hole size 0.015	Hole offset 0.030 (in.)	Wrench clearance min. (in.)	Tongue width cable size (in.)										
			#8 Code #8 Weld	#6 Code #6 Weld	#4 Code #4 Weld	#2 Code #4 Weld	#1 Code #2 Weld	1/0 Code #1 Weld	2/0 Code 1/0 Weld	3/0 Code 2/0 Weld	4/0 Code 3/0 Weld	250 Code	
#8	0.173	0.200	0.240	0.406	0.437	0.562	0.593	0.672	0.750	0.825	0.937	1.030	1.125
#10	0.204	0.218	0.250	0.406	0.437	0.562	0.593	0.672	0.750	0.825	0.937	1.030	1.125
1/4	0.281	0.250	0.312	0.469	0.500	0.562	0.593	0.672	0.750	0.825	0.937	1.030	1.125
5/16	0.344	0.375	0.406	0.562	0.562	0.562	0.675	0.672	0.750	0.825	0.937	1.030	1.125
3/8	0.406	0.375	0.440	0.578	0.578	0.594	0.675	0.672	0.750	0.825	0.937	1.030	1.125
1/2	0.531	0.500	0.562	-	-	-	0.750	0.750	0.750	0.825	0.937	1.030	1.125
5/8	0.656	0.625	0.875	-	-	-	-	-	-	-	0.937	1.030	1.125
3/4	0.812	0.750	0.770	-	-	-	-	-	-	-	-	-	-
7/8*	0.937	0.875	0.890	-	-	-	-	-	-	-	-	-	-
1*	1.062	0.937	1.000	-	-	-	-	-	-	-	-	-	-

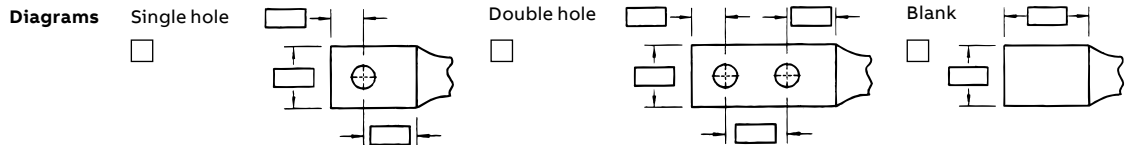

* These bolt holes available in one-hole lug only.

Chart B

Cable size (AWG or kcmil)	Tongue thickness (in.)	Straight lug barrel length plus transition (in.)		Barrel (in.)		Dim "X" Stacked lugs (in.)			Dim "Y" (in.)		Dim "H" (in.)	
		Short	Long	O.D.	I.D.	Straight	45°	90°	Short	Long	Short	Long
#8	0.080	0.635	0.935	0.260	0.180	0.158	0.478	0.394	0.595	0.808	0.779	1.079
#6	0.081	0.675	0.975	0.296	0.215	0.134	0.544	0.432	0.587	0.799	0.767	1.067
#4	0.099	0.685	0.985	0.365	0.266	0.175	0.622	0.502	0.637	0.849	0.838	1.138
#2	0.108	0.815	1.115	0.410	0.302	0.216	0.649	0.535	0.711	0.923	0.958	1.258
#1	0.106	0.825	1.275	0.467	0.361	0.212	0.731	0.592	0.710	1.028	0.956	1.406
1/0	0.125	0.975	1.325	0.520	0.396	0.250	0.789	0.646	0.794	1.042	1.075	1.425
2/0	0.125	0.965	1.315	0.571	0.446	0.250	0.859	0.696	0.829	1.077	1.125	1.475
3/0	0.125	1.085	1.435	0.632	0.507	0.250	0.946	0.757	0.900	1.148	1.225	1.575
4/0	0.137	1.255	1.705	0.701	0.564	0.274	1.031	0.826	1.015	1.333	1.387	1.837
250	0.137	1.375	1.925	0.766	0.629	0.274	1.123	0.891	1.085	1.474	1.487	2.037
300	0.153	1.900	2.675	0.850	0.660	0.459	1.226	0.975	1.180	1.726	1.924	2.679
350	0.177	2.090	2.896	0.926	0.720	0.531	1.333	1.103	1.267	1.830	2.096	2.896
400	0.173	2.460	2.980	0.960	0.757	0.519	1.370	1.085	1.551	1.913	2.484	2.984
500	0.218	2.670	3.610	1.100	0.852	0.654	1.514	1.225	1.629	2.266	2.669	3.619
600	0.244	2.900	3.490	1.200	0.926	0.732	1.630	1.325	1.762	2.147	2.897	3.497
700	0.228	2.784	-	1.255	0.997	0.684	1.662	1.375	1.780	-	3.011	-
750	0.270	3.050	3.925	1.330	1.030	0.810	1.745	1.455	1.827	2.434	3.050	3.925
800	0.266	3.213	-	1.375	1.079	0.800	1.728	1.625	1.952	2.787	3.213	4.554
900	0.313	3.450	4.550	1.500	1.145	0.940	1.900	1.650	2.065	-	1.387	-
1,000	0.297	3.356	4.500	1.550	1.203	0.890	2.070	1.675	2.031	2.787	1.487	4.506

Note: Stacking lugs are available for one bolt only. Consult factory: straight: 700 kcmil & up – 45°: 400 kcmil & up, 90°: 500 kcmil & up.

Chart C

Bolt hole size	Tongue width 0.030 code cable size (in.)										
	300 kcmil 4/0 Weld	350 kcmil	400 kcmil	500 kcmil 400 Weld	600 kcmil 500 Weld	1325/24	700 kcmil	750 kcmil	800 kcmil	900 kcmil	1000 kcmil
#8	-	-	-	-	-	-	-	-	-	-	-
#10	-	-	-	-	-	-	-	-	-	-	-
¼	1.250	1.355	1.410	1.605	1.745	1.805	1.840	1.935	2.010	2.180	2.265
⅝	1.250	1.355	1.410	1.605	1.745	1.805	1.840	1.935	2.010	2.180	2.265
¾	1.250	1.355	1.410	1.605	1.745	1.805	1.840	1.935	2.010	2.180	2.265
½	1.250	1.355	1.410	1.605	1.745	1.805	1.840	1.935	2.010	2.180	2.265
⅝	1.250	1.355	1.410	1.605	1.745	1.805	1.840	1.935	2.010	2.180	2.265
¾	1.250	1.355	1.410	1.605	1.745	1.805	1.840	1.935	2.010	2.180	2.265
7/8*	-	-	-	1.605	1.745	1.805	1.840	1.935	2.010	2.180	2.265
1*	-	-	-	-	1.745	1.805	1.840	1.935	2.010	2.180	2.265

Diagrams

Formula 1 = (.125 + 2 (O.D.) + .037 – Tongue thickness)

Straight stack

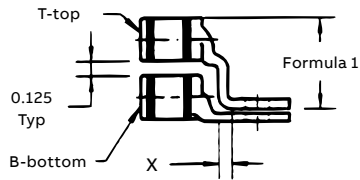

45° stack

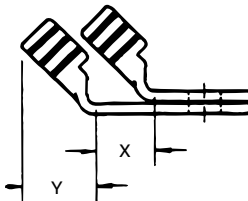

90° stack

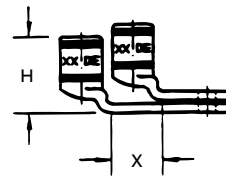

45°



90°

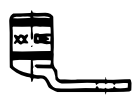

* These bolt holes available in one-hole lug only.

Compression connectors for copper conductor

One-hole lugs – Standard barrel 600 V to 35 kV



Material – High-conductivity wrought copper
Finish – Electro tin plate



One-hole lugs – Standard barrel 600 V to 35 kV

Diagrams	Cat. no.	Code (AWG or kcmil)	Wire size Flex class G, H, I, K, M†	Bolt size (in.)	Dimensions (in)						Die code	Die color	
					A	B	C	D	E	F			
	54101	#14-10	–	¼	1.23	0.56	0.50	0.05	0.20	¼	ERG4002	"C" nest	
	256-30695-1351			#8	1.36	0.68	0.36	0.05	0.20	¼	ERG4005		
	256-30695-1352			¼	1.36	0.68	0.41	0.05	0.20	¼			
	256-30695-263			¼	1.69	0.81	0.50	0.07	0.20	¼			
	54104	#8	23 Navy	#10	1.16	0.50	0.39	0.08	0.25	7/32	21	Red	
	54130		#8 Weld	¼	1.20	0.61	0.45	0.07	0.25	¼	21		
	54131		37/24 = 14.9 kcmil	5/16	1.33	0.64	0.56	0.05	0.25	9/32	21		
	54132			3/8	1.33	0.64	0.56	0.05	0.25	9/32	21		
	256-30695-424			½	1.75	1.31	1.00	0.13	0.25	½	21		
		256-30695-1361	#6	#30 Navy	#12	1.23	0.53	0.44	0.07	0.31	7/32	24	Blue
		54134		#6 Weld	#10	1.23	0.53	0.44	0.07	0.31	7/32	24	
		54105		61/24 = 24.6 kcmil	¼	1.23	0.53	0.44	0.07	0.31	7/32	24	
		54135		133/0.014	5/16	1.41	0.67	0.60	0.07	0.31	5/16	24	
		54136			3/8	1.41	0.67	0.60	0.07	0.31	5/16	24	
256-30695-282				3/8	1.41	0.75	0.56	0.06	0.31	5/16	24		
256-30695-422				½	1.75	1.31	1.00	0.13	0.31	½	24		
	256-30695-1362	#4	#4 Weld	#12	1.38	0.60	0.55	0.09	0.37	¼	29	Gray	
	54138		40–50 Navy	#10	1.38	0.60	0.55	0.09	0.37	¼	29		
	54106		91/24 = 36.7 kcmil	¼	1.38	0.60	0.55	0.09	0.37	¼	29		
	54139		133/0.0177	5/16	1.42	0.66	0.61	0.07	0.37	5/16	29		
	54140		49/0.029	3/8	1.42	0.66	0.61	0.07	0.37	5/16	29		
	256-30695-233		#5 91/24	3/8	1.56	0.75	0.59	0.06	0.37	5/16	29		
	256-30695-264			½	2.20	1.40	1.00	0.06	0.37	½	29		
	54107	#2	#60 Navy	¼	1.50	0.65	0.59	0.11	0.41	¼	33	Brown	
	54142-TB		125/24 = 50.5 kcmil	5/16	1.73	0.88	0.59	0.11	0.41	3/8	33		
	54143-TB		#3 Weld	3/8	1.65	0.80	0.59	0.11	0.41	3/8	33		
	54145-TB			½	1.92	1.08	0.75	0.08	0.41	½	33		
	54108	#1	75 Navy, #2 Weld	¼	1.50	0.65	0.68	0.11	0.47	¼	37		Green
54147		150/24 = 60.5 kcmil	5/16	1.73	0.93	0.68	0.11	0.47	3/8	37			
54148		175/24 = 70.6 kcmil	3/8	1.78	0.98	0.68	0.11	0.47	3/8	37			
54150		133/0.0223	½	2.10	1.25	0.76	0.11	0.47	½	37			
	54152-TB	1/0	#100 Navy	¼	1.60	0.65	0.75	0.13	0.52	¼	42	Pink	
	54153-TB		#1 Weld	5/16	1.83	0.88	0.75	0.13	0.52	3/8	42		
	54109		225/24 = 90.8 kcmil	3/8	1.88	0.93	0.75	0.13	0.52	3/8	42		
	54155-TB		133/0.0254	½	2.20	1.25	0.75	0.13	0.52	½	42		
	256-30695-1383			5/8	2.54	1.50	0.88	0.13	0.52	5/8	42		

† Contact technical services for specific stranding listings.
 Tooling – see pages 104-127. Die selector chart – see pages 128-133.

Compression connectors for copper conductor

One-hole lugs – Standard barrel 600 V to 35 kV (continued)



Material – High-conductivity wrought copper

Finish – Electro tin plate



One-hole lugs – Standard barrel 600 V to 35 kV

Diagrams	Cat. no.	Code (AWG or kcmil)	Wire size Flex class G, H, I, K, M [†]	Bolt size (in.)	Dimensions (in)						Die code	Die color	
					A	B	C	D	E	F			
	54157	2/0	125 Navy	1/4	1.65	0.65	0.83	0.13	0.57	1/4	45	Black	
	54158		1/0 Weld	5/16	1.88	0.88	0.83	0.13	0.57	3/8	45		
	54110		275/24 = 111 kcmil	3/8	1.93	0.93	0.83	0.13	0.57	3/8	45		
	54160		427/0.0155	1/2	2.25	1.25	0.83	0.13	0.57	1/2	45		
	256-30695-131		133/0.0282	5/8	2.56	1.50	0.83	0.13	0.57	5/8	45		
		54162-TB	3/0	150 Navy, 2/0 Weld	1/4	1.75	0.65	0.92	0.13	0.63	1/4	50	Orange
		54163-TB		325/24 = 131 kcmil	5/16	1.98	0.88	0.92	0.13	0.63	3/8	50	
		54111		133/0.0316, 259/0.0227	3/8	2.03	0.93	0.92	0.13	0.63	3/8	50	
		54165-TB		427/0.0177	1/2	2.35	1.25	0.92	0.13	0.63	1/2	50	
			54167	4/0	200 Navy	1/4	1.90	0.65	1.03	0.14	0.70	1/4	54
54168			3/0 Weld	5/16	2.13	0.87	1.03	0.14	0.70	3/8	54		
54112			450/24 = 182 kcmil	3/8	2.18	0.93	1.03	0.14	0.70	3/8	54		
54170			703/0.0154	1/2	2.50	1.25	1.03	0.14	0.70	1/2	54	Yellow	
256-30695-1174				3/4	2.86	1.56	1.03	0.14	0.70	3/4	54		
58161	-		4/0 Weld	1/4	2.23	0.78	1.25	0.15	0.79	3/8	62		
	58162		550/24 = 222 kcmil	5/16	2.33	0.88	1.25	0.15	0.79	3/8	62	White	
	58163		133/0.0399	3/8	2.38	0.93	1.25	0.15	0.79	3/8	62		
	58165		259/0.0286	1/2	2.76	1.25	1.25	0.15	0.79	1/2	62		
	58166		637/0.0183	5/8	3.03	1.58	1.25	0.15	0.79	5/8	62		
	54172-TB	250	250 Navy	1/4	2.00	0.65	1.13	0.14	0.77	1/2	62	White	
	54173			5/16	2.23	0.88	1.13	0.14	0.77	3/8	62		
	54174			3/8	2.28	0.93	1.13	0.14	0.77	3/8	62		
	54113			1/2	2.60	1.25	1.13	0.14	0.77	1/2	62		
	58168	-	250 Weld, 50/24 = 262 kcmil, 259/0.0311, 703/0.0189	1/2	2.70	1.25	1.25	0.15	0.85	1/2	66		
	54178	300	300 Navy	5/16	2.33	0.88	1.25	0.15	0.85	3/8	66	Red	
54179			3/8	2.43	0.93	1.25	0.15	0.85	3/8	66			
54114			1/2	2.70	1.25	1.25	0.15	0.85	1/2	66			
54181			5/8	3.03	1.58	1.25	0.15	0.85	3/8	66			
58171	-	300 Weld, 259/0.034, 427/0.0265, 889/0.0183 775/24 = 313 kcmil	1/2	2.85	1.25	1.36	0.18	0.93	1/2	71			
256-30695-112	350	350 Navy	3/8	2.90	1.13	1.36	0.18	0.93	1/2	71			
54115			1/2	2.85	1.25	1.36	0.18	0.93	1/2	71			
54183			5/8	3.21	1.58	1.36	0.18	0.93	3/4	71			

[†] Contact technical services for specific stranding listings.

Tooling – see pages 104-127. Die selector chart – see pages 128-133.

Compression connectors for copper conductor

One-hole lugs – Standard barrel 600 V to 35 kV (continued)



Material – High-conductivity wrought copper

Finish – Electro tin plate



One-hole lugs – Standard barrel 600 V to 35 kV

Diagrams	Cat. no.	Code (AWG or kcmil)	Wire size Flex class G, H, I, K, M†	Bolt size (in.)	Dimensions (in)						Die code	Die color
					A	B	C	D	E	F		
	58174	-	350 Weld, 259/0.0368, 427/0.0285, 703/0.0224, 889/0.0201	1/2	3.35	1.25	1.61	0.22	1.09	1/2	76	Blue
	54116	400	400 Navy	1/4	3.20	1.25	1.41	0.17	0.96	1/2	76	Blue
	54185	-	400 Navy	5/8	3.53	1.58	1.41	0.17	0.96	3/4	76	Blue
	256-30695-1403	-	400 Weld	3/8	3.31	1.31	1.61	0.22	1.04	5/8	80	-
	58177	-	925/24 = 373 kcmil 259/0.0393 or 427/0.0306	1/2	3.31	1.25	1.61	0.22	1.04	1/2	80	-
	256-30695-339	500	500 Navy	3/8	3.10	1.00	1.61	0.22	1.10	3/8	87	Brown
	54118	-	500 Navy	1/2	3.30	1.25	1.61	0.22	1.10	1/2	87	Brown
	54187	-	500 Navy	5/8	3.63	1.58	1.61	0.22	1.10	5/8	87	Brown
	58180	-	450 Flex, 1127, 4522 1100/24 = 444 kcmil	5/8	3.79	1.58	1.75	0.24	1.20	5/8	94	Green
	256-30695-1370	600	-	1/2	3.65	1.44	1.75	0.24	1.20	31/64	94	Green
	54120	-	600 Navy	5/8	3.79	1.58	1.75	0.24	1.20	5/8	94	Green
	54122-TB	700	-	5/8	3.68	1.58	1.84	0.23	1.26	5/8	99	Pink
	256-30695-1404	-	1325/24 = 535 kcmil	3/8	3.29	1.29	1.81	0.28	1.25	21/32	99	Pink
	256-30695-1405	-	500 Flex 427/0.0342	1/2	3.29	1.29	1.81	0.28	1.25	21/32	99	Pink
	256-30695-840	-	259, 4125, 5054	1/2	4.00	1.69	1.81	0.28	1.25	31/64	99	Pink
58182	-	600 Navy	5/8	3.83	1.58	1.81	0.28	1.25	5/8	99	Pink	
256-30695-193	750	600 Flex 427	1/2	4.00	1.69	1.94	0.27	1.33	31/64	106	Black	
54123-TB	-	750 Navy	5/8	3.87	1.58	1.94	0.27	1.33	5/8	106	Black	
58184	-	1600/24 = 646 kcmil	5/8	3.80	1.58	1.94	0.27	1.33	5/8	106	Black	
54124-TB	800	800 Navy	5/8	4.04	1.58	2.01	0.27	1.38	5/8	107	Orange	
256-30695-843	900	1925/24 = 777 kcmil	1/2	4.31	1.81	2.17	0.31	1.50	7/8	115	Yellow	
54126	-	900 Navy	5/8	4.15	1.58	2.17	0.31	1.50	5/8	115	Yellow	
54126	-	900 Navy	5/8	4.15	1.58	2.17	0.31	1.50	5/8	115	Yellow	
54128	1000	1000 Navy	5/8	4.09	1.58	2.27	0.30	1.55	5/8	125	-	

† Contact technical services for specific stranding listings.

Note: angled lugs can be readily available as: 15°, 30°, 45°, 60°, and 90°.

Tooling – see pages 104-127. Die selector chart – see pages 128-133.

Compression connectors for copper conductor

One-hole lugs – 45° Standard barrel 600 V to 35 kV



Material – High-conductivity wrought copper
Finish – Electro tin plate



One-hole lugs – 45° Standard barrel 600 V to 35 kV

Cat. no.	Code (AWG or kcmil)	Wire size Flex class G, H, I, K, M†	Bolt size (in.)	Dimensions (in)					Die code	Die color	
				B	C	D	E	F			
Diagrams	54104UF	#8	23 Navy	#10	0.50	0.39	0.08	0.25	7/32	21	Red
	54130UF		#8 Weld	1/4	0.61	0.45	0.07	0.25	1/4	21	
	54131UF		37/24 = 14.9 kcmil	5/16	0.64	0.56	0.05	0.25	9/32	21	
	54132UF			3/8	0.64	0.56	0.05	0.25	9/32	21	
	54134UF	#6	30 Navy	#10	0.53	0.44	0.07	0.31	7/32	24	Blue
	54105UF		#6 Weld	1/4	0.53	0.44	0.07	0.31	7/32	24	
	54135UF		61/24 = 24.6 kcmil	5/16	0.67	0.60	0.07	0.31	5/16	24	
	54136UF		133/0.014	3/8	0.67	0.60	0.07	0.31	5/16	24	
	54138UF	#4	#4 Weld	#10	0.60	0.55	0.09	0.37	1/4	29	Gray
	54106UF		40–50 Navy	1/4	0.60	0.55	0.09	0.37	1/4	29	
	54139UF		91/24 = 36.7 kcmil	5/16	0.66	0.61	0.07	0.37	5/16	29	
	54140UF		133/0.0177	3/8	0.66	0.61	0.07	0.37	5/16	29	
	256-30695-264UF		49/0.029	3/8	0.66	0.61	0.07	0.37	5/16	29	
	54107UF	#2	#5–91/24	1/2	1.40	1.00	0.06	0.37	1/2	29	
	54107UF	#2	60 Navy	1/4	0.65	0.59	0.11	0.41	1/4	33	Brown
	54142UF		125/24 = 50.4 kcmil	5/16	0.88	0.59	0.11	0.41	3/8	33	
	54143UF		#3 Weld	3/8	0.80	0.59	0.11	0.41	3/8	33	
	54145UF			1/2	1.08	0.75	0.08	0.41	1/2	33	
	54108UF	#1	75 Navy, #2 Weld	1/4	0.65	0.68	0.11	0.47	1/4	37	Green
	54147UF		150/24 = 60.5 kcmil	5/16	0.93	0.68	0.11	0.47	3/8	37	
	54148UF		175/24 = 70.6 kcmil	3/8	0.98	0.68	0.11	0.47	3/8	37	
	54150UF		133/0.0223	1/2	1.25	0.76	0.11	0.47	1/2	37	
	54152UF	1/0	100 Navy	1/4	0.65	0.75	0.13	0.52	1/4	42	Pink
	54153UF		#1 Weld	5/16	0.88	0.75	0.13	0.52	3/8	42	
	54109UF		225/24 = 90.8 kcmil	3/8	0.93	0.75	0.13	0.52	3/8	42	
	54155UF		133/0.0254	1/2	1.25	0.75	0.13	0.52	1/2	42	
	54157UF	2/0	125 Navy	1/4	0.65	0.83	0.13	0.57	1/4	45	Black
	54158UF		1/0 Weld	5/16	0.88	0.83	0.13	0.57	3/8	45	
	54110UF		275/24 = 111 kcmil	3/8	0.93	0.83	0.13	0.57	3/8	45	
	54160UF		427/0.0155, 133/0.0282	1/2	1.25	0.83	0.13	0.57	1/2	45	
	54162UF	3/0	150 Navy, 2/0 Weld	1/4	0.65	0.92	0.13	0.63	1/4	50	Orange
	54163UF		325/24 = 131 kcmil	5/16	0.88	0.92	0.13	0.63	3/8	50	
	54111UF		133/0.0316, 259/0.0227	3/8	0.93	0.92	0.13	0.63	3/8	50	
	54165UF		427/0.0177	1/2	1.25	0.92	0.13	0.63	1/2	50	
	54167UF	4/0	200 Navy	1/4	0.65	1.03	0.14	0.70	1/4	54	Purple
	54168UF		3/0 Weld	5/16	0.87	1.03	0.14	0.70	3/8	54	
	54112UF		450/24 = 182 kcmil	3/8	0.93	1.03	0.14	0.70	3/8	54	
	54170UF		703/0.0154	1/2	1.25	1.03	0.14	0.70	1/2	54	
	58161UF	–	4/0 Weld	1/4	0.78	1.25	0.15	0.79	3/8	62	Yellow
	58162UF		550/24 = 222 kcmil	5/16	0.88	1.25	0.15	0.79	3/8	62	
	58163UF		133/0.0399	3/8	0.93	1.25	0.15	0.79	3/8	62	
	58165UF		259/0.0286	1/2	1.25	1.25	0.15	0.79	1/2	62	
	58166UF		637/0.0183	5/8	1.58	1.25	0.15	0.79	5/8	62	
	58166UF			5/8	1.58	1.25	0.15	0.79	5/8	62	

† Contact technical services for specific stranding listings. Tooling – see pages 104-127. Die selector chart – see pages 128-133.

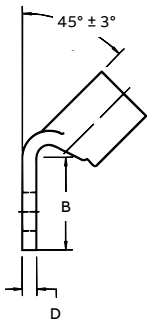
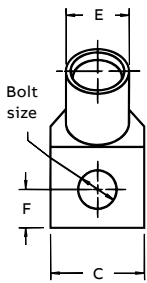

Compression connectors for copper conductor

One-hole lugs – 45° Standard barrel 600 V to 35 kV (continued)



Material – High-conductivity wrought copper

Finish – Electro tin plate



One-hole lugs – 45° Standard barrel 600 V to 35 kV

Diagrams	Cat. no.	Code (AWG or kcmil)	Wire size		Bolt size (in.)	Dimensions (in)					Die code	Die color	
			Flex class G, H, I, K, M [†]			B	C	D	E	F			
	54172UF	250	250 Navy		1/4	0.65	1.13	0.14	0.77	1/4	62	Yellow	
	54173UF				5/16	0.88	1.13	0.14	0.77	3/8	62		
	54174UF				3/8	0.93	1.13	0.14	0.77	3/8	62		
	54113UF				1/2	1.25	1.13	0.14	0.77	1/2	62		
	58168UF	–		250 Weld, 650/24 = 262 kcmil, 259/0.0311, 703/0.0189		1/2	1.25	1.25	0.15	0.85	1/2	66	White
	54178UF	300		300 Navy		5/16	0.88	1.25	0.15	0.85	3/8	66	
	54179UF					3/8	0.93	1.25	0.15	0.85	3/8	66	
	54114UF					1/2	1.25	1.25	0.15	0.85	1/2	66	
	54181UF					5/8	1.58	1.25	0.15	0.85	5/8	66	
	58171UF	–		300 Weld, 259/0.034, 427/0.0265, 889/0.0183 775/24 = 313 kcmil		1/2	1.25	1.36	0.18	0.93	1/2	71	Red
	54115UF06	350		350 Navy		3/8	1.25	1.36	0.18	0.93	1/2	71	Red
	54115UF					1/2	1.25	1.36	0.18	0.93	1/2	71	
	54183UF					5/8	1.58	1.36	0.18	0.93	5/8	71	
	58174UF	–		350 Weld, 259/0.0368, 427/0.0285, 703/0.0224, 889/0.0201		1/2	1.25	1.61	0.22	1.09	1/2	76	Blue
	54116UF	400		400 Navy		1/2	1.25	1.41	0.17	0.96	1/2	76	Blue
	54185UF					5/8	1.58	1.41	0.17	0.96	5/8	76	
	58177UF06			400 Weld 925/24 = 373 kcmil		3/8	1.31	1.61	0.22	1.04	5/8	80	–
	58177UF					1/2	1.25	1.61	0.22	1.04	1/2	80	
	54118UF	500		500 Navy		1/2	1.25	1.61	0.22	1.10	1/2	87	Brown
	54187UF					5/8	1.58	1.61	0.22	1.10	5/8	87	
58180UF	–		1100/24 = 444 kcmil, 450, 1127 / 450, 4522		5/8	1.58	1.75	0.24	1.20	1/2	94	Green	
54120UF	600		–		5/8	1.58	1.75	0.24	1.20	1/2	94		
54122UF	700		–		5/8	1.58	1.84	0.23	1.26	1/2	99	Pink	
58182UF	–		1325/24 = 535 kcmil		1/2	1.69	1.81	0.28	1.25	13/16	99	Pink	
58182UF			427/0.0342		5/8	1.58	1.81	0.28	1.25	5/8	99		
54123UF	750		600 Flex 427 Str.		5/8	1.58	1.94	0.27	1.33	5/8	106		
58184UF	–		1600/24 = 646 kcmil		5/8	1.58	1.94	0.27	1.33	5/8	106		
54124UF	800		800 Navy		5/8	1.58	2.01	0.27	1.38	5/8	107	Orange	
54126UF	900		1925/24 = 777 kcmil, 900 Navy		5/8	1.58	2.17	0.31	1.50	5/8	115	Yellow	
54128UF	1000		1000 Navy		5/8	1.58	2.27	0.30	1.55	5/8	125	–	

[†] Contact technical services for specific stranding listings. Tooling – see pages 104-127. Die selector chart – see pages 128-133.

Compression connectors for copper conductor

One-hole lugs – 90° Standard barrel 600 V to 35 kV



Material – High-conductivity wrought copper
Finish – Electro tin plate



One-hole lugs – 90° Standard barrel 600 V to 35 kV

Diagrams	Cat. No.	Code (AWG or kcmil)	Wire size Flex class G, H, I, K, M ¹	Bolt size (in.)	Dimensions (in)					Die code	Die color	
					B	C	D	E	F			
	54104UB	#8	23 Navy	#10	0.50	0.39	0.08	0.25	7/32	21	Red	
	54130UB		#8 Weld	1/4	0.61	0.45	0.07	0.25	1/4	21		
	54131UB		37/24 = 14.9 kcmil	5/16	0.64	0.56	0.05	0.25	9/32	21		
	54132UB			3/8	0.64	0.56	0.05	0.25	9/32	21		
		54134UB	#6	30 Navy	#10	0.53	0.44	0.07	0.31	7/32	24	Blue
		54105UB		#6 Weld	1/4	0.53	0.44	0.07	0.31	7/32	24	
		54135UB		61/24 = 24.6 kcmil	5/16	0.67	0.60	0.07	0.31	5/16	24	
		54136UB		133/0.014	3/8	0.67	0.60	0.07	0.31	5/16	24	
		54138UB	#4	#4 Weld	#10	0.60	0.55	0.09	0.37	1/4	29	Gray
		54106UB		40–50 Navy	1/4	0.60	0.55	0.09	0.37	1/4	29	
54139UB			91/24 = 36.7 kcmil	5/16	0.66	0.61	0.07	0.37	5/16	29		
54140UB			133/0.0177	3/8	0.66	0.61	0.07	0.37	5/16	29		
256-30695-264UB			49/0.029	3/8	0.66	0.61	0.07	0.37	5/16	29		
54107UB		#2	60 Navy	1/4	0.65	0.59	0.11	0.41	1/4	33	Brown	
54142UB			125/24 = 50.4 kcmil	5/16	0.88	0.59	0.11	0.41	3/8	33		
54143UB			#3 Weld	3/8	0.80	0.59	0.11	0.41	3/8	33		
54145UB				1/2	1.08	0.75	0.08	0.41	1/2	33		
		54108UB	#1	75 Navy, #2 Weld	1/4	0.65	0.68	0.11	0.47	1/4	37	Green
	54147UB		150/24 = 60.5 kcmil	5/16	0.93	0.68	0.11	0.47	3/8	37		
	54148UB		175/24 = 70.6 kcmil	3/8	0.98	0.68	0.11	0.47	3/8	37		
	54150UB		133/0.0223	1/2	1.25	0.76	0.11	0.47	1/2	37		
	54152UB	1/0	100 Navy	1/4	0.65	0.75	0.13	0.52	1/4	42	Pink	
	54153UB		#1 Weld	5/16	0.88	0.75	0.13	0.52	3/8	42		
	54109UB		225/24 = 90.8 kcmil	3/8	0.93	0.75	0.13	0.52	3/8	42		
	54155UB		133/0.0254	1/2	1.25	0.75	0.13	0.52	1/2	42		
	54157UB	2/0	125 Navy	1/4	0.65	0.83	0.13	0.57	1/4	45	Black	
	54158UB		1/0 Weld	5/16	0.88	0.83	0.13	0.57	3/8	45		
	54110UB		275/24 = 111 kcmil	3/8	0.93	0.83	0.13	0.57	3/8	45		
	54160UB		427/0.0155, 133/0.0282	1/2	1.25	0.83	0.13	0.57	1/2	45		
	54162UB	3/0	150 Navy, 2/0 Weld	1/4	0.65	0.92	0.13	0.63	1/4	50	Orange	
	54163UB		325/24 = 131 kcmil	5/16	0.88	0.92	0.13	0.63	3/8	50		
	54111UB		133/0.0316, 259/0.0227	3/8	0.93	0.92	0.13	0.63	3/8	50		
	54165UB		427/0.0177	1/2	1.25	0.92	0.13	0.63	1/2	50		
	54167UB	4/0	200 Navy	1/4	0.65	1.03	0.14	0.70	1/4	54	Purple	
	54168UB		3/0 Weld	5/16	0.87	1.03	0.14	0.70	3/8	54		
	54112UB		450/24 = 182 kcmil	3/8	0.93	1.03	0.14	0.70	3/8	54		
	54170UB		703/0.0154	1/2	1.25	1.03	0.14	0.70	1/2	54		
	58161UB	-	4/0 Weld	1/4	0.78	1.25	0.15	0.79	3/8	62	Yellow	
	58162UB		550/24 = 222 kcmil	5/16	0.88	1.25	0.15	0.79	3/8	62		
	58163UB		133/0.0399	3/8	0.93	1.25	0.15	0.79	3/8	62		
	58165UB		259/0.0286	1/2	1.25	1.25	0.15	0.79	1/2	62		
	58166UB		637/0.0183	5/8	1.58	1.25	0.15	0.79	5/8	62		

¹Contact technical services for specific stranding listings. Tooling – see pages 104-127. Die selector chart – see pages 128-133.

Compression connectors for copper conductor

One-hole lugs – 90° Standard barrel 600 V to 35 kV (continued)



Material – High-conductivity wrought copper

Finish – Electro tin plate



One-hole lugs – 90° Standard barrel 600 V to 35 kV

Diagrams	Cat. no.	Code (AWG or kcmil)	Wire size Flex class G, H, I, K, M [†]	Bolt size (in.)	Dimensions (in)					Die code	Die color
					B	C	D	E	F		
	54172UB	250	250 Navy	1/4	0.65	1.13	0.14	0.77	1/4	62	Yellow
	54173UB			5/16	0.88	1.13	0.14	0.77	3/8	62	
	54174UB			3/8	0.93	1.13	0.14	0.77	3/8	62	
	54113UB			1/2	1.25	1.13	0.14	0.77	1/2	62	
	58168UB	–	250 Weld, 650/24 = 262 kcmil, 259/0.0311, 703/0.0189	1/2	1.25	1.25	0.15	0.85	1/2	66	
	54178UB	300	300 Navy	5/16	0.88	1.25	0.15	0.85	3/8	66	
	54179UB			3/8	0.93	1.25	0.15	0.85	3/8	66	
	54114UB			1/2	1.25	1.25	0.15	0.85	1/2	66	
	54181UB			5/8	1.58	1.25	0.15	0.85	5/8	66	
		58171UB	–	300 Weld, 259/034, 427/0.0265, 889/0.0183 775/24 = 313 kcmil	1/2	1.25	1.36	0.18	0.93	1/2	71
256-30695-112UB		350	350 Navy	3/8	1.25	1.36	0.18	0.93	1/2	71	
54115UB				1/2	1.25	1.36	0.18	0.93	1/2	71	
54183UB				5/8	1.58	1.36	0.18	0.93	5/8	71	
58174UB		–	350 Weld, 259/0.0368, 427/0.0285, 703/0.0224, 889/0.0201	1/2	1.25	1.61	0.22	1.09	1/2	76	Blue
54116UB		400	400 Navy	1/2	1.25	1.41	0.17	0.96	1/2	76	
54185UB				5/8	1.58	1.41	0.17	0.96	5/8	76	
256-30695-1403UB		–	400 Weld, 925/24 = 373 kcmil 259/0.0393, 427/0.0306	3/8	1.31	1.61	0.22	1.04	5/8	80	
58177UB				1/2	1.25	1.61	0.22	1.04	1/2	80	
		54118UB	500	500 Navy	1/2	1.25	1.61	0.22	1.10	1/2	87
	54187UB			5/8	1.58	1.61	0.22	1.10	5/8	87	
	58180UB	–	1100/24 = 444 kcmil, 450, 1127 450, 4522	5/8	1.58	1.75	0.24	1.20	5/8	94	Green
	54120UB	600	–	5/8	1.58	1.75	0.24	1.20	5/8	94	
	54122UB	700	–	5/8	1.58	1.84	0.23	1.26	5/8	99	Pink
	256-30695-840UB	–	1325/24 = 535 kcmil 500 Flex, 427/0.0342, 259, 1125, 5054	1/2	1.69	1.81	0.28	1.25	13/16	99	
	58182UB			5/8	1.58	1.81	0.28	1.25	5/8	99	
	54123UB	750	600 Flex 427	5/8	1.58	1.94	0.27	1.33	5/8	106	Black
	58184UB	–	1600/24 = 646 kcmil	5/8	1.58	1.94	0.27	1.33	5/8	106	
	54124UB	800	800 Navy	5/8	1.58	2.01	0.27	1.38	5/8	107	Orange
54126UB	900	1925/24 = 777 kcmil, 900 Navy	5/8	1.58	2.17	0.31	1.50	5/8	115	Yellow	
54128UB	1000	1000 Navy	5/8	1.58	2.27	0.30	1.55	5/8	125		–

[†] Contact technical services for specific stranding listings. Tooling – see pages 104-127. Die selector chart – see pages 128-133.

Compression connectors for copper conductor

Two-hole lugs – Standard barrel 600 V to 35 kV



Material – High-conductivity wrought copper
Finish – Electro tin plate



Two-hole lugs – Standard barrel 600 V to 35 kV

Diagrams	Cat. no.	Code (AWG or kcmil)	Wire size Flex class G, H, I, K, M†	Bolt size (in.)	Dimensions (in)					Die code	Die color		
					A	B	C	D	E			F	G
	54201	#14-10	–	1/4	1.86	1.19	0.50	0.05	0.20	1/4	5/8	ERG4002, "C" Nest	
	256-30695-1302			3/8	2.48	1.81	0.56	0.04	0.22	3/8	1	ERG4005	
	54204	#8	23 Navy	#10	1.88	1.18	0.42	0.08	0.26	1/4	5/8	21	Red
	256-31426-33*	#7 LS	#8 Weld	#10	1.88	1.18	0.41	0.06	0.26	7/32	5/8-3/4	21	
	256-31426-33PH		37/24 = 14.9 kcmil	#10	1.88	1.18	0.41	0.06	0.26	7/32	5/8-3/4	21	
	542040410			1/4	2.01	1.31	0.42	0.08	0.26	1/4	5/8	21	
	542040416			1/4	2.38	1.68	0.42	0.08	0.26	1/4	1	21	
	256-30695-1094			1/4	2.50	1.81	0.56	0.05	0.26	1/4	3/4	21	
	256-30695-251			1/4	2.50	1.81	0.56	0.05	0.26	3/8	1	21	
	256-30695-1070	#6	30 Navy	#12	1.81	1.19	0.44	0.11	0.30	1/4	1/2-5/8	24	
	256-30695-1153		#6 Weld	#10	1.98	1.28	0.44	0.08	0.30	1/4	1/2	24	
	256-30695-1183		61/24 = 24.6 kcmil	#10	1.98	1.19	0.44	0.08	0.30	7/32	5/8-3/4	24	
	54205		133/0.014	1/4	1.98	1.28	0.44	0.08	0.30	1/4	5/8	24	Blue
	256-30695-1095		#5 Weld	1/4	2.13	1.31	0.43	0.08	0.30	1/4	3/4	24	
	256-30695-252			1/4	2.38	1.63	0.43	0.08	0.30	1/4	1	24	
	256-30695-372			1/4	2.13	1.43	0.43	0.08	0.30	1/4	3/4	24	
	256-30695-913			1/4	2.38	1.75	0.43	0.08	0.30	1/4	1	24	
	256-30695-253			3/8	2.58	1.81	0.55	0.08	0.30	3/8	1	24	
	54206	#4	40-50 Navy, #4 Weld	1/4	2.03	1.28	0.52	0.10	0.37	1/4	5/8	29	
	256-30695-1184		#5, 91/24 = 36.7 kcmil	5/16	2.31	1.63	0.52	0.10	0.37	5/16	1	29	
	256-30695-255		133/0.0177, 49/0.029	3/8	2.56	1.81	0.59	0.09	0.37	3/8	1	29	
	54207	#3	#3 Flex	1/4	2.13	1.28	0.59	0.11	0.41	1/4	5/8	33	
	256-30695-1355	#2	60 Navy	1/4	2.15	1.31	0.59	0.13	0.41	1/4	3/4	33	Brown
	256-30695-1185		125/24 = 50.4 kcmil	1/4	2.38	1.53	0.59	0.11	0.41	1/4	1	33	
	256-30695-257			3/8	2.67	1.81	0.60	0.1	0.41	3/8	1	33	
	256-30695-1049			1/2	3.75	2.88	0.75	0.09	0.41	5/16	1 3/4	33	
	54208	#1	75 Navy, #2 Weld	1/4	2.13	1.28	0.68	0.11	0.47	1/4	5/8	37	
	256-30695-1233		150/24 = 60.5 kcmil	5/16	2.69	1.62	0.69	0.13	0.47	1 1/32	1	37	Green
	256-30695-1236		175/24 = 70.6 kcmil	3/8	2.75	1.81	0.68	0.11	0.47	3/8	1	37	
	256-30695-329	1/0	100 Navy	1/4	2.75	1.81	0.75	0.14	0.52	3/8	3/4	42	
	54255		#1 Weld	5/16	2.56	1.56	0.75	0.14	0.52	3/8	7/8	42	Pink
	256-30695-1234		225/24 = 90.8 kcmil	5/16	2.75	1.78	0.75	0.14	0.52	1/3	1	42	
	54209		133/0.0254	3/8	2.88	1.93	0.75	0.13	0.52	3/8	1	42	
	256-30695-1265			3/8	3.50	2.57	0.75	0.14	0.52	3/8	1 3/4	42	
	256-30695-886			1/2	3.78	2.83	0.75	0.13	0.52	1/2	1 3/4	42	
	256-30695-1175	2/0	125 Navy	1/4	2.45	1.44	0.83	0.14	0.57	1/4	3/4	45	
	54261		1/0 Weld	5/16	2.70	1.63	0.83	0.14	0.57	1/3	7/8	45	Black
	256-30695-832		275/24 = 111 kcmil	5/16	2.88	1.81	0.81	0.14	0.57	3/8	1	45	
	54210		133/0.0282	3/8	2.93	1.93	0.83	0.13	0.57	3/8	1	45	
	54260			1/2	3.83	2.81	0.83	0.14	0.57	3/8	1 3/4	45	
	54266	3/0	150 Navy, 2/0 Weld	5/16	2.88	1.75	0.94	0.14	0.63	1/3	1	50	
	54211		325/24 = 131 kcmil	3/8	2.94	1.81	0.94	0.14	0.63	3/8	1	50	Orange
	54265		133/0.0316, 259/0.0227, 427/0.0177	1/2	3.94	2.81	0.94	0.14	0.63	1/2	1 3/4	50	

† Contact technical services for specific stranding listings; * Blind end. Tooling – see pages 104-127. Die selector chart – see pages 128-133.

Compression connectors for copper conductor

Two-hole lugs – Standard barrel 600 V to 35 kV (continued)



Material – High-conductivity wrought copper

Finish – Electro tin plate



Two-hole lugs – Standard barrel 600 V to 35 kV

Diagrams	Cat. no.	Code (AWG or kcmil)	Wire size Flex class G, H, I, K, M†	Bolt size (in.)	Dimensions (in)							Die code	Die color	
					A	B	C	D	E	F	G			
<p>Tongue marking: UL, CSA, T&B logo and cable size</p>	54212	4/0	200 Navy	3/8	3.18	1.93	1.03	0.14	0.70	3/8	1	54	Purple	
	54270		3/0 Weld	1/2	4.25	3.00	1.03	0.14	0.70	1/2	1 3/4	54		
	256-30695-1247		450/24 = 182 kcmil	1/4	3.06	1.44	1.03	0.16	0.70	3/8	5/8	54		
	256-30695-331		703/0.0154	1/4	3.06	1.81	1.03	0.14	0.70	3/8	3/4	54		
	256-30695-1261			5/16	3.18	1.93	1.03	0.14	0.70	3/8	1	54		
	54213	250	250 Navy	3/8	3.28	1.93	1.13	0.14	0.77	3/8	1	62		Yellow
	54275			1/2	4.19	2.81	1.13	0.18	0.77	1/2	1 3/4	62		
	256-30695-345	-	4/0 Weld	3/8	3.25	1.69	1.25	0.15	0.79	3/8	7/8	62		
	256-30695-835		550/24 = 222 kcmil	3/8	4.25	2.80	1.25	0.15	0.79	3/8	1	62		
	256-30695-452		133/0.0399	3/8	3.13	1.88	1.25	0.16	0.79	3/8	7/8	62		
58265		259/0.0286, 637/0.018	1/2	3.94	2.81	.94	0.14	0.79	1/2	1 3/4	62	White		
54214	300	300 Navy	3/8	3.45	1.93	1.25	0.15	0.85	3/8	1	66			
54280		262, 650/24, 250 Weld	1/2	4.45	3.00	1.25	0.15	0.85	1/2	1 3/4	66			
256-30695-332	350	350 Navy	1/4	3.40	1.81	1.36	0.18	0.93	3/8	3/4	71		Red	
256-30695-1240			5/16	4.18	2.63	1.36	0.18	0.93	3/8	1 3/4	71			
54215			3/8	3.51	1.93	1.36	0.18	0.93	3/8	1	71			
54282			1/2	4.60	3.00	1.36	0.18	0.93	1/2	1 3/4	71	Blue		
54216	400	400 Navy	3/8	3.93	1.93	1.41	0.17	0.96	3/8	1	76			
54283		313, 775/24, 300 Weld	3/8	3.88	1.93	1.41	0.17	0.96	3/8	1 1/16	76			
256-30695-439	-	400 Weld	3/8	4.35	2.25	1.61	0.22	1.04	5/8	1	80		-	
58277		925/24 = 373 kcmil	1/2	5.06	3.00	1.61	0.22	1.04	1/2	1 3/4	80			
256-30695-839		259/0.0393, 427/0.0306	3/8	4.09	2.06	1.61	0.22	1.04	1/2	1	80	Brown		
54218	500	500 Navy	3/8	3.96	1.93	1.61	0.22	1.10	3/8	1	87			
54286			1/2	5.07	3.00	1.61	0.22	1.10	1/2	1 3/4	87			
256-30695-188			1/2	4.06	2.31	1.63	0.22	1.10	1/2	1 1/4	87			
54220	600	450 Flex I, K	3/8	4.13	1.93	1.75	0.24	1.20	3/8	1	94		Green	
54289		1100/24 = 444 kcmil	1/2	5.23	3.00	1.75	0.24	1.20	1/2	1 3/4	94			
256-30695-1406	700	-	3/8	4.05	2.11	1.78	0.24	1.25	1/2	1	99	Pink		
256-30695-842			3/8	4.30	2.06	1.80	0.28	1.25	1/2	1	99			
256-30695-898			3/8	4.30	2.06	1.80	0.28	1.25	1/2	1	99			
54291			1/2	5.18	3.00	1.84	0.23	1.25	1/2	1 3/4	99			
58281	-	500 Flex, 535, 1325/24	1/2	5.23	3.00	1.80	0.28	1.25	1/2	1 3/4	99			
256-30695-237	750	600, 427 Str.	3/8	5.10	2.80	1.94	0.27	1.33	3/8	1	106	Black		
54223			1/2	5.32	3.00	1.94	0.27	1.33	1/2	1 3/4	106			
256-30695-1376	800	800 Navy	3/8	4.78	2.28	2.01	0.27	1.38	7/16	1 1/8	107	Orange		
54224			1/2	5.50	3.00	2.01	0.27	1.38	1/2	1 3/4	107			
256-30695-694	900	1925/24 = 777 kcmil	3/8	4.65	2.06	2.18	0.31	1.50	1/2	1	115	Yellow		
54226			1/2	5.59	3.00	2.18	0.31	1.50	1/2	1 3/4	115			
256-30695-846			3/8	4.60	2.06	2.12	0.31	1.50	1/2	1	115			
256-30695-844			5/8	5.00	2.63	2.18	0.31	1.50	9/16	1 1/2	115			
54228	1000	1000 Navy	1/2	5.45	3.00	2.27	0.30	1.55	1/2	1 3/4	125		-	

† Contact technical services for specific stranding listings.
Tooling – see pages 104-127. Die selector chart – see pages 128-133.

Compression connectors for copper conductor

Two-hole lugs – 45° Standard barrel 600 V to 35 kV



Material – High-conductivity wrought copper

Finish – Electro tin plate



Two-hole lugs – 45° Standard barrel 600 V to 35 kV

Diagrams	Cat. no.	Code (AWG or kcmil)	Wire size Flex class G, H, i, k, m†	Bolt size (in.)	Dimensions (in)						Die code	Die color
					B	C	D	E	F	G		
	56-31426-9	#14-10	–	#10	1.22	0.37	0.05	2.00	1/4	5/8	–	–
	54204UF	#8 #7 LS	23 Navy #8 Weld 37/24 = 14.9 kcmil	#10	1.18	0.42	0.08	0.26	1/4	5/8	21	Red
	256-30695-1183UF	#6	30 Navy, #6 Weld	#10	1.19	0.44	0.08	0.30	7/32	5/8-3/4	24	Blue
	54205UF		61/24 = 24.6 kcmil	1/4	1.28	0.44	0.08	0.30	1/4	5/8	24	
	54205UF0416		133/0.014, #5 Weld	1/4	1.56	0.43	0.08	0.30	1/4	1	24	
	54206UF	#4	40-50 Navy, #4 Weld #5, 91/24 = 36.7 kcmil 133/0.0177, 49/0.029	1/4	1.28	0.52	0.10	0.37	1/4	5/8	29	Gray
	54207UF	#3	60 Navy, #3 Flex	1/4	1.28	0.59	0.11	0.41	1/4	5/8	33	Brown
	256-30695-257UF	#2	125/24 = 50.4 kcmil	3/8	1.81	0.60	0.11	0.41	3/8	1	33	
	54208UF	#1	75 Navy, #2 Weld 150/24 = 60.5 kcmil 175/24 = 70.6 kcmil, 133/0.0223	1/4	1.28	0.68	0.11	0.47	1/4	5/8	37	Green
	54209UF	1/0	100 Navy #1 Weld	3/8	1.93	0.75	0.13	0.52	3/8	1	42	Pink
	54209UF0412		225/24 = 90.8 kcmil 133/0.0254	1/4	1.55	0.75	0.13	0.52	1/4	3/4	42	
	54261UF	2/0	125 Navy, 1/0 Weld	5/16	1.63	0.83	0.14	0.57	1/2	7/8	45	Black
	54210UF		275/24 = 111 kcmil	3/8	1.93	0.83	0.13	0.57	3/8	1	45	
	54260UF		133/0.0282	1/2	2.81	0.83	0.14	0.57	3/8	1 3/4	45	
	54266UF	3/0	150 Navy, 2/0 Weld	5/16	1.75	0.94	0.14	0.63	1/2	1	50	Orange
54211UF		325/24 = 131 kcmil	3/8	1.81	0.94	0.14	0.63	3/8	1	50		
54265UF		133/0.0316, 259/0.0227, 427/0.0177	1/2	2.81	0.94	0.14	0.63	1/2	1 3/4	50		
54212UF	4/0	200 Navy	3/8	1.93	1.03	0.14	0.70	3/8	1	54	Purple	
54270UF		3/0 Weld 450/24 = 182 kcmil 703/0.0154	1/2	3.00	1.03	0.14	0.70	1/2	1 3/4	54		

† Contact technical services for specific stranding listings.

Tooling – see pages 104-127. Die selector chart – see pages 128-133.

Compression connectors for copper conductor

Two-hole lugs – 45° Standard barrel 600 V to 35 kV (continued)



Material – High-conductivity wrought copper

Finish – Electro tin plate



Two-hole lugs – 45° Standard barrel 600 V to 35 kV

Diagrams	Cat. no.	Code (AWG or kcmil)	Wire size Flex class G, H, I, K, M [†]	Bolt size (in.)	Dimensions (in)						Die code	Die color	
					B	C	D	E	F	G			
	54213UF	250	250 Navy	3/8	1.93	1.13	0.14	0.77	3/8	1	62	Yellow	
	54275UF			1/2	2.81	1.13	0.18	0.77	1/2	1 3/4	62		
	256-30695-399UF	–	4/0 Weld	3/8	2.80	1.25	0.15	0.79	3/8	1	62		
	58265UF		550/24 = 222 kcmil 133/0.0399, 259/0.0286 637/0.018	1/2	2.81	0.94	0.14	0.79	1/2	1 3/4	62		
		54214UF	300	262, 350/24, 250 Weld	3/8	1.93	1.25	0.15	0.85	3/8	1	66	White
		54280UF		300 Navy	1/2	3.00	1.25	0.15	0.85	1/2	1 3/4	66	
		54215UF	350	350 Navy	3/8	1.93	1.36	0.18	0.93	3/8	1	71	Red
		54282UF			1/2	3.00	1.36	0.18	0.93	1/2	1 3/4	71	
		54216UF	400	400 Navy, 313	3/8	1.93	1.41	0.17	0.96	3/8	1	76	Blue
		54283UF		775/24, 300 Weld	3/8	1.93	1.41	0.17	0.96	3/8	1 1/16	76	
58277UF		–	400 Weld	1/2	3.00	1.61	0.22	1.04	1/2	1 3/4	80	–	
				925/24 = 373 kcmil 259/0.0393, 427/0.0306									
		54218UF	500	500 Navy	3/8	1.93	1.61	0.22	1.10	3/8	1	87	Brown
		54286UF			1/2	3.00	1.61	0.22	1.10	1/2	1 3/4	87	
	54220UF	600	450 Flex I, K	3/8	1.93	1.75	0.24	1.20	3/8	1	94	Green	
	54289UF		1100/24 = 444 kcmil	1/2	3.00	1.75	0.24	1.20	1/2	1 3/4	94		
	54291UF	700	–	1/2	3.00	1.84	0.23	1.25	1/2	1 3/4	99	Pink	
	58281UF	–	500 Flex	1/2	3.00	1.8	0.28	1.25	1/2	1 3/4	99		
	54223UF0616	750	1325/24 535	3/8	2.80	1.94	0.27	1.33	3/8	1	106	Black	
	54223UF		600, 427 Str.	1/2	3.00	1.94	0.27	1.33	1/2	1 3/4	106		
	54224UF	800	800 Navy	1/2	3.00	2.01	0.27	1.38	1/2	1 3/4	106	Yellow	
	54226UF	900	1925/24 = 777 kcmil	1/2	3.00	2.18	0.31	1.50	1/2	1 3/4	115		
54228UF	1000	1000 Navy	1/2	3.00	2.27	0.30	1.55	1/2	1 3/4	125	–		

[†] Contact technical services for specific stranding listings.

Note: angled lugs can be readily available as: 15°, 30°, 45°, 60°, and 90°.

Tooling – see pages 104-127. Die selector chart – see pages 128-133.

Compression connectors for copper conductor

Two-hole lugs – 90° Standard barrel 600 V to 35 kV



Material – High-conductivity wrought copper
Finish – Electro tin plate



Two-hole lugs – 90° Standard barrel 600 V to 35 kV

Diagrams	Cat. no.	Code (AWG or kcmil)	Wire size Flex class G, H, I, K, M†	Bolt size (in.)	Dimensions (in)						Die code	Die color
					B	C	D	E	F	G		
	CA256-31426-141	#14-10	-	#10	1.25	0.37	0.07	0.20	7/32	5/8	ERG4002, "C" Nest	
	256-31426-6SPH			#10	1.30	0.37	0.07	0.20	7/32	5/8-3/4	ERG4005	
	256-31426-6			#10	1.30	0.37	0.07	0.20	7/32	5/8		
	256-31426-6S			#10	1.30	0.37	0.07	0.20	7/32	5/8-3/4		
	256-30695-1409	#8	23 Navy, #8 Weld	#10	1.19	0.41	0.06	0.26	7/32	5/8-3/4	21	Red
	54204UB	#7 LS	37/24 = 14.9 kcmil	#10	1.25	0.42	0.08	0.26	1/4	5/8	21	Red
	256-31426-33UB*			#10	1.19	0.41	0.06	0.26	7/32	5/8-3/4	21	
	256-31426-33UBPH			#10	1.19	0.41	0.06	0.26	7/32	5/8-3/4	21	
	256-30695-1411	#6	30 Navy	#10	1.19	0.44	0.08	0.30	7/32	5/8-3/4	24	Blue
	256-30695-1183B		#6 Weld	#10	1.19	0.44	0.08	0.30	7/32	5/8-3/4	24	Blue
256-30695-1356		133/0.014	#10	1.19	0.43	0.08	0.30	7/32	5/8	24	Blue	
54205UB		#5 Weld	1/4	1.28	0.44	0.08	0.30	1/4	5/8	24	Blue	
256-30695-252UB			1/4	1.56	0.43	0.08	0.30	1/4	1	24	Blue	
54206UB	#4	40-50 Navy #4 Weld	1/4	1.28	0.52	0.10	0.37	1/4	5/8	29	Gray	
		#5 91/24 = 36.7 kcmil										
		133/0.0177, 49/0.029										
54207UB	#3	60 Navy	1/4	1.28	0.59	0.11	0.41	1/4	5/8	33	Brown	
	#2	#3 Weld										
		125/24 = 50.4 kcmil										
54208UB	#1	75 Navy #2 Weld	1/4	1.28	0.68	0.11	0.47	1/4	5/8	37	Green	
		150/24 = 60.5 kcmil										
		175/24 = 70.6 kcmil,										
		133/0.0223										
54209UB	1/0	100 Navy, #1 Weld	3/8	1.93	0.75	0.13	0.52	3/8	1	42	Pink	
54209UB0412		225/24 = 90.8 kcmil,	1/4	1.55	0.75	0.13	0.52	1/4	3/4	42	Pink	
		133/0.0254										
		225/24 = 90.8 kcmil,										
		133/0.0254										
54261UB	2/0	125 Navy, 1/0 Weld	5/16	1.63	0.83	0.14	0.57	1 1/32	7/8	45	Black	
54210UB		275/24 = 111 kcmil	3/8	1.93	0.83	0.13	0.57	3/8	1	45	Black	
54260UB		133/0.0282	1/2	2.81	0.83	0.14	0.57	3/8	1 3/4	45	Black	
54266UB	3/0	150 Navy, 2/0 Weld	5/16	1.75	0.94	0.14	0.63	1 1/32	1	50	Orange	
54211UB		325/24 = 131 kcmil	3/8	1.81	0.94	0.14	0.63	3/8	1	50	Orange	
54265UB		133/0.0316, 259/0.0227,	1/2	2.81	0.94	0.14	0.63	3/8	1 3/4	50	Orange	
		427/0.0177										
54212UB	4/0	200 Navy, 3/0 Weld	3/8	1.93	1.03	0.14	0.70	3/8	1	54	Purple	
54270UB		450/24 = 182 kcmil,	1/2	3.00	1.03	0.14	0.70	1/2	1 3/4	54	Purple	
		703/0.0154										
54213UB	250	250 Navy	3/8	1.93	1.13	0.14	0.77	3/8	1	62	Yellow	
54275UB			1/2	2.81	1.13	0.18	0.77	1/2	1 3/4	62	Yellow	
256-30695-399UB	-	4/0 Weld, 550/24 = 222 kcmil	3/8	2.80	1.25	0.15	0.79	3/8	1	62	Yellow	
58265UB		133/0.0399, 259/0.0286,	1/2	2.81	0.94	0.14	0.79	1/2	1 3/4	62	Yellow	
		637/0.018										

† Contact technical services for specific stranding listings; * Blind end.
 Tooling – see pages 104-127. Die selector chart – see pages 128-133.

Compression connectors for copper conductor

Two-hole lugs – 45° Standard barrel 600 V to 35 kV (continued)



Material – High-conductivity wrought copper

Finish – Electro tin plate



Two-hole lugs – 45° Standard barrel 600 V to 35 kV

Diagrams	Cat. no.	Code (AWG or kcmil)	Wire size		Dimensions (in)							Die code	Die color
			Flex class G, H, I, K, M [†]	Bolt size (in.)	B	C	D	E	F	G			
	54214UB	300	262, 650/24, 250 Weld	3/8	1.93	1.25	0.15	0.85	3/8	1	66	White	
	54280UB		300 Navy	1/2	3.00	1.25	0.15	0.85	1/2	1 3/4	66		
	54215UB	350	350 Navy	3/8	1.93	1.36	0.18	0.93	3/8	1	71	Red	
	54282UB			1/2	3.00	1.36	0.18	0.93	1/2	1 3/4	71		
	54216UB	400	400 Navy	3/8	1.93	1.41	0.17	0.96	3/8	1	76	Blue	
	54283UB		313, 775/24, 300 Weld	3/8	1.93	1.41	0.17	0.96	3/8	1 1/16	76		
	58277UB	-	400 Weld, 925/24 = 373 kcmil 259/0.0393, 427/0.0306	1/2	3.00	1.61	0.22	1.04	1/2	1 3/4	80	-	
	54218UB	500	500 Navy	3/8	1.93	1.61	0.22	1.10	3/8	1	87	Brown	
	54286UB			1/2	3.00	1.61	0.22	1.10	1/2	1 3/4	87		
	54220UB	600	1100/24 = 444 kcmil	3/8	1.93	1.75	0.24	1.20	3/8	1	94	Green	
	54289UB		450 Flex I, K	1/2	3.00	1.75	0.24	1.20	1/2	1 3/4	94		
	54291UB	700	-	1/2	3.00	1.84	0.23	1.25	1/2	1 3/4	99	Pink	
	58281UB	-	500 Flex, 1325/24 = 535 kcmil	1/2	3.00	1.80	0.28	1.25	1/2	1 3/4	99		
	54223UB	750	600, 427 Str.	1/2	3.00	1.94	0.27	1.33	1/2	1 3/4	106	Black	
	54224UB	800	800 Navy	1/2	3.00	2.01	0.27	1.38	1/2	1 3/4	106		
	54226UB	900	1925/24 = 777 kcmil	1/2	3.00	2.18	0.31	1.50	1/2	1 3/4	115	Yellow	
	54228UB	1000	1000 Navy	1/2	3.00	2.27	0.30	1.55	1/2	1 3/4	125	-	

[†] Contact technical services for specific stranding listings.
Tooling – see pages 104-127. Die selector chart – see pages 128-133.

Compression connectors for copper conductor

Narrow-tongue lugs – One- and two-hole, standard barrel, 600 V applications



Ideal for confined-space terminations

Material – High-conductivity wrought copper

Finish – Electro tin plate



Narrow-tongue lugs – One-hole standard barrel, 600 V applications

Diagrams	Wire size		Dimensions (in)										Die code	Die color		
	Cat. no.	Code (AWG or kcmil)	Flex class G, H, I, K, M†	Bolt size (in.)												
					A	B	C	D	E	F	H					
<p>One-hole lug</p>	54138NT	#4	91/24	#10	1.31	0.56	0.37	0.10	0.37	0.25	-	29	Gray			
	54107NT	#2-3	125/24	¼	1.50	0.65	0.41	0.07	0.41	0.25	-	33	Brown			
<p>One-hole and two-hole lug</p>	54108NT	#1	150,175/24	¼	1.50	0.65	0.47	0.11	0.47	0.25	-	37	Green			
	54152NT	1/0	225/24	¼	1.60	0.65	0.52	0.13	0.52	0.25	-	42	Pink			
	54157NT	2/0	275/24	¼	1.60	0.65	0.57	0.13	0.57	0.25	-	45	Black			
	54162NT	3/0	325/24	¼	1.68	0.65	0.63	0.13	0.63	0.25	-	50	Orange			
	54167NT	4/0	450/24	¼	1.90	0.65	0.70	0.14	0.70	0.25	-	54	Purple			
	54172NT	250	-	¼	2.00	0.65	0.77	0.14	0.77	0.25	-	62	Yellow			
	54178NT04	300	-	¼	2.33	0.88	0.85	0.15	0.85	0.25	-	66	White			
	54115NT	350	-	½	2.75	1.25	0.93	0.18	0.93	0.50	-	71	Red			
	54115NT06	350	-	¾	2.50	1.00	0.93	0.18	0.93	0.38	-	71	Brown			
	54118NT	500	-	½	3.25	1.25	1.10	0.22	1.10	0.50	-	87	Brown			
	54123NT08	750	-	½	3.48	1.25	1.33	0.27	1.33	0.50	-	106	Black			
	54123NT	750	-	⅝	3.80	1.58	1.33	0.27	1.33	0.63	-	106	Black			

† Contact technical services for specific stranding listings.

* Special lugs may have other catalog number constructions. Please contact technical services.

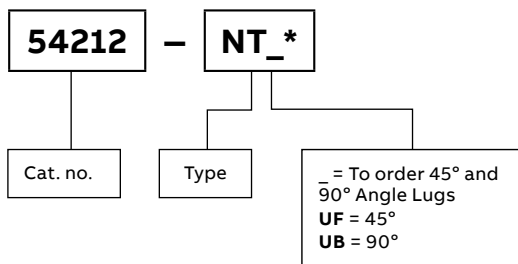

Ordering information

Other options include silver plating (add SP to catalog number), blind end (add BE to catalog number) and peep holes (add PH to catalog number).

Catalog no. example:

54108NTUB is a 90° angled one-hole narrow-tongue lug for #1 AWG.

Compression connectors for copper conductor

Narrow-tongue lugs – One- and two-hole, standard barrel, 600 V applications (continued)



Ideal for confined-space terminations

Material – High-conductivity wrought copper

Finish – Electro tin plate



Narrow-tongue lugs – Two-hole, standard barrel, 600 V applications

Diagrams	Cat. no.	Code (AWG or kcmil)	Wire size Flex class G, H, I, K, M†	Bolt size (in.)	Dimensions (in)							Die code	Die color
					A	B	C	D	E	F	H		
<p>Two-hole lug</p> <p>One-hole and two-hole lug</p>	54206NT0310	#4	91/24	#10	1.88	1.13	0.37	0.10	0.37	0.25	0.63	29	Gray
	54207NT	#2-3	125/24	¼	2.04	1.19	0.41	0.11	0.41	0.25	0.63	33	Brown
	54207NT0412	#2-3	125/24	¼	2.16	1.31	0.41	0.11	0.41	0.25	0.75	33	Brown
	54207NT0416	#2-3	125/24	¼	2.41	1.56	0.41	0.11	0.41	0.25	1.00	33	Brown
	54208NT	#1	150,175/24	¼	2.04	1.19	0.47	0.11	0.47	0.25	0.63	37	Green
	54208NT0516	#1	150,175/24	5/16	2.63	1.78	0.47	0.11	0.47	0.38	1.00	37	Green
	54255NT	1/0	225/24	5/16	2.61	1.66	0.52	0.14	0.52	0.38	0.88	42	Pink
	54261NT	2/0	275/24	5/16	2.66	1.66	0.57	0.14	0.57	0.38	0.88	45	Black
	54210NT	2/0	275/24	3/8	2.82	1.82	0.57	0.14	0.57	0.38	1.00	45	Black
	54266NT	3/0	325/24	5/16	2.88	1.78	0.63	0.13	0.63	0.38	1.00	50	Orange
	54211NT	3/0	325/24	3/8	2.92	1.82	0.63	0.13	0.63	0.38	1.00	50	Orange
	54212NT	4/0	450/24	3/8	3.07	1.82	0.70	0.14	0.70	0.38	1.00	54	Purple
	54213NT	250	–	3/8	3.17	1.82	0.77	0.14	0.77	0.38	1.00	62	Yellow
	54275NT	250	–	3/8	4.16	2.81	0.77	0.14	0.77	0.50	1.75	62	Yellow
	54282NT	350	–	½	4.36	2.81	0.93	0.18	0.93	0.50	1.75	71H	Red
	54218NT	500	–	3/8	4.57	2.57	1.10	0.22	1.10	0.38	1.75	87	Brown
	54286NT	500	–	½	4.81	2.81	1.10	0.22	1.10	0.50	1.75	87	Brown
	54878BENTPH	600	–	½	5.83	3.00	1.20	0.24	1.20	0.50	1.75	94	Green
	54223NT0628	750	–	3/8	4.79	2.57	1.33	0.27	1.33	0.38	1.75	106H	Black
	54223NT0616	750	–	3/8	5.00	2.02	1.66	0.27	1.33	0.38	1.00	106	Black
54223NT	750	–	½	5.04	2.81	1.33	0.27	1.33	0.50	1.75	106H	Black	
58884BENTPH	–	1600/24	½	6.16	3.00	1.33	0.24	1.20	0.50	1.75	106H	Black	
58825NT	900	1925/24 = 777 kcmil	3/8	5.00	2.13	1.66	0.31	1.50	0.50	1.00	115	Yellow	
58825NT0828	900	1925/24 = 777 kcmil	½	5.75	2.88	1.66	0.31	1.50	0.50	1.75	115	Yellow	

† Contact technical services for specific stranding listings.
Tooling – see pages 104-127. Die selector chart – see pages 128-133.

* Special lugs may have other catalog number constructions. Please contact technical services.

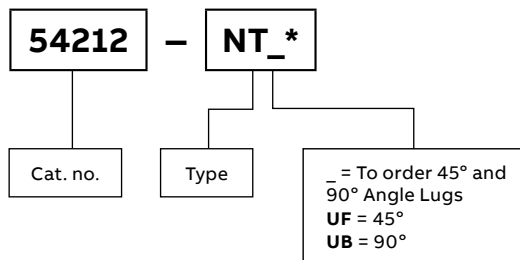

Ordering information

Other options include silver plating (add SP to catalog number), blind end (add BE to catalog number) and peep holes (add PH to catalog number).

Catalog no. example:

54108NTUB is a 90° angled one-hole narrow-tongue lug for #1 AWG.

Compression connectors for copper conductor

Insulated lugs



Reduce your installation time and labor costs
 Now you can have all of the benefits of Thomas & Betts' industry-leading Blackburn® lugs featuring the Color-Keyed® system – without the time-consuming job of insulating them after installation. These lugs come fitted with a translucent nylon sleeve that provides excellent dielectric strength, while still enabling easy viewing of the color-coding on the barrel. In addition to the standard catalog numbers listed here for one- and two-hole lugs, a variety of custom options makes this the broadest offering of insulated lugs available on the market.

- Translucent nylon insulator provides easy viewing of die code/color
- Use with #8 AWG to 250 kcmil copper conductors
- Available in one- and two-hole configurations with standard-length barrel
- Variety of options available – finish, tongue width and angle, bolt hole size/spacing and more
- Easy to install with standard Blackburn compression tools TBM6S, 25000, 13642M or 13400 with adapter

Insulated lugs



Cat. no.	Wire size (AWG or kcmil)	Bolt size (in.)	Dimensions (in)					Hole spacing	Die for TBM6s or 25000 tool	Die for 13642M tool
			A	B	C	D	E			
One-hole standard-barrel nylon-insulated lugs										
54104I	#8	#10	1.49	0.50	0.39	0.08	0.35	-	11821-CK	21707M-CK
54105I	#6	3/4	1.58	0.53	0.44	0.07	0.45	-	11822-CK	21708M-CK
54106I	#4	3/4	1.76	0.60	0.55	0.09	0.53	-	11823-CK	21709M-CK
54108I	#1	3/4	2.06	0.65	0.68	0.11	0.60	-	11824-CK	21710M-CK
54109I	1/0	3/8	2.36	0.93	0.75	0.13	0.64	-	11825-CK	21711M-CK
54110I	2/0	3/8	2.43	0.93	0.83	0.13	0.69	-	11826-CK	21712M-CK
54111I	3/0	3/8	2.54	0.93	0.92	0.13	0.77	-	11827-CK	21713M-CK
54112I	4/0	3/8	2.75	0.93	1.03	0.14	0.80	-	11828-CK	21714M-CK
54113I	250	1/2	3.19	1.25	1.13	0.14	0.88	-	11829-CK	21715M-CK
Two-hole standard-barrel nylon-insulated lugs										
54204I	#8	#10	2.21	1.18	0.42	0.08	0.35	0.625	11821-CK	21707M-CK
54205I	#6	3/4	2.32	1.28	0.44	0.08	0.45	0.625	11822-CK	21708M-CK
54206I	#4	3/4	2.40	1.28	0.52	0.10	0.53	0.625	11823-CK	21709M-CK
54208I	#1	3/4	2.69	1.28	0.68	0.11	0.60	0.625	11824-CK	21710M-CK
54209I	1/0	3/8	3.36	1.93	0.75	0.13	0.64	1.000	11825-CK	21711M-CK
54210I	2/0	3/8	3.43	1.93	0.83	0.13	0.69	1.000	11826-CK	21712M-CK
54211I	3/0	3/8	3.45	1.81	0.94	0.14	0.77	1.000	11827-CK	21713M-CK
54212I	4/0	3/8	3.75	1.93	1.03	0.14	0.80	1.000	11828-CK	21714M-CK
54213I	250	1/2	3.87	1.93	1.13	0.14	0.88	1.000	11829-CK	21715M-CK

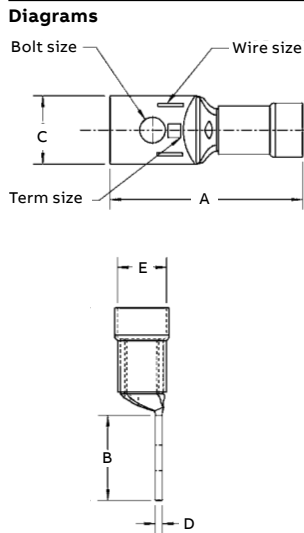

Specifications

- Material – Lugs: seamless copper tubing with electrotin plate finish
- Material – Insulators: injection-molded nylon
- Temperature rating: 105 °C max.
- Voltage rating: 600 V max. (1,000 V max. in signs and fixtures)
- Listings: UL® listed, CSA certified

Compression connectors for copper conductor

One-hole lugs – Long barrel 600 V to 35 kV



Peep holes available – Add suffix PH

Material – High-conductivity wrought copper

Finish – Electro tin plate



One-hole lugs – Long barrel 600 V to 35 kV

Diagrams	Cat. no.	Code (AWG or kcmil)	Wire size		Dimensions (in)						Die code	Die color	
			Flex class G, H, I, K, M†	Bolt size (in.)	A	B	C	D	E	F			
	54901BE	#14–10		–	¼	1.23	0.56	0.50	0.05	0.20	¼	ERG4002, ERG4005	“C” nest
	54929BE*	#8	23 Navy, #8 Flex	#10	1.65	0.65	0.42	0.08	0.26	¼	21	Red	
	54930BE*		37/24 = 14.9 kcmil	¼	1.65	0.65	0.42	0.08	0.26	¼	21		
	54904BE*	#6	#6 Flex, 30 Navy,	#10	1.65	0.65	0.44	0.08	0.30	¼	24	Blue	
	54905BE*		#5 Weld	¼	1.65	0.65	0.44	0.08	0.30	¼	24		
	54908BE*	#4	40–30 Navy, #4 Weld	#10	1.70	0.65	0.52	0.10	0.37	¼	29	Gray	
	54906BE*		#5 91/24 = 36.7 kcmil	¼	1.70	0.65	0.52	0.10	0.37	¼	29		
	54933BE*	#2–3	125/24 = 50.4 kcmil	#10	1.88	0.65	0.59	0.11	0.41	¼	33	Brown	
	54942BE*		60 Navy, #3 Weld	5/16	2.03	0.88	0.59	0.11	0.41	3/8	33		
	54945BE	#1	75 Navy, #2 Weld	#10	1.95	0.65	0.68	0.11	0.47	¼	37	Green	
	54947BE		150/24 = 60.5 kcmil	5/16	2.18	0.88	0.68	0.11	0.47	3/8	37		
	54946BE	1/0	100 Navy	#10	1.95	0.65	0.75	0.13	0.52	¼	42	Pink	
	54949BE		#1 Weld	5/16	2.18	0.88	0.75	0.13	0.52	3/8	42		
	54909BE		225/24 = 90.8 kcmil	3/8	2.23	0.93	0.75	0.13	0.52	3/8	42		
	54950BE			½	2.55	1.25	0.75	0.13	0.52	½	42		
	54910BE	2/0	125 Navy, 1/0 Weld	3/8	2.28	0.93	0.83	0.13	0.57	3/8	45	Black	
	54951BE		275/24 = 111 kcmil	½	2.60	1.25	0.83	0.13	0.57	½	45		
	54965BE	3/0	325/24 = 131 kcmil, 150 Navy, 2/0 Weld	½	2.70	1.25	0.92	0.13	0.63	½	50	Orange	
	256-30695-1252	4/0	200 Navy	¼	2.35	0.65	1.03	0.14	0.70	¼	54	Purple	
	256-30695-1253		450/24 = 182 kcmil	3/8	2.95	1.25	1.03	0.14	0.70	3/8	54		
	54970BE		3/0 Weld	½	2.95	1.25	1.03	0.14	0.70	½	54		
54913BE	250	550/24 = 222 kcmil, 250 Navy, 4/0 Weld	½	3.15	1.25	1.13	0.14	0.77	½	62	Yellow		
54914BE	300	300 Navy, 250 Weld, 262, 650/24	½	3.50	1.25	1.25	0.15	0.85	½	66	White		
54915BE	350		–	½	3.68	1.25	1.36	0.18	0.93	½	71	Red	
54916BE	400	400 Navy, 300 Flex	–	½	3.75	1.25	1.41	0.17	0.96	½	76	Blue	
54917BE		775/24 = 313 kcmil, 350, 254 Str.	–	5/8	4.03	1.58	1.41	0.17	0.96	5/8	76		
54918BE	500	925/24 = 373 kcmil	–	½	4.25	1.25	1.61	0.22	1.10	½	87	Brown	
54919BE		400 Weld, 350, 3458 Str.	–	5/8	4.57	1.58	1.61	0.22	1.10	5/8	87		
54921BE	600	450 I, K	–	½	4.10	1.25	1.75	0.24	1.20	½	94	Green	
54920BE		1100/24 = 444 kcmil	–	5/8	4.39	1.58	1.75	0.24	1.20	5/8	94		
54979BE	–	1325/24 = 535 kcmil	–	½	4.40	1.25	1.80	0.24	1.25	½	99	Pink	
54922BE	750	1325/24 = 535 kcmil	–	½	4.40	1.25	1.94	0.27	1.33	½	106	Black	
54923BE		500 Weld	–	5/8	4.72	1.58	1.94	0.27	1.33	5/8	106		
58984BE	–	1600/24 = 646 kcmil	–	5/8	4.73	1.58	1.94	0.27	1.33	5/8	106		
58926BE	900	1925/24 = 777 kcmil	–	5/8	5.23	1.58	2.17	0.31	1.50	5/8	115	Yellow	
54928BE	1000		–	5/8	5.24	1.58	2.27	0.30	1.55	5/8	125	–	
256-30695-918			–	7/8	5.42	1.82	2.37	0.30	1.55	7/8	125		

† Contact technical services for specific stranding listings. * UL* listed for direct-burial applications. Tooling – see pages 104-127. Die selector chart – see pages 128-133.

Compression connectors for copper conductor

One-hole lugs – 45° Long barrel 600 V to 35 kV



Peep holes available – Add suffix PH

Material – High-conductivity wrought copper

Finish – Electro tin plate



One-hole lugs – 45° Long barrel 600 V to 35 kV

Diagrams	Cat. No.	Code (AWG or kcmil)	Wire size Flex class G, H, I, K, M†	Bolt size (in.)	Dimensions (in)					Die code	Die color
					B	C	D	E	F		
	54929BEUF	#8	23 Navy, #8 Flex	#10	0.65	0.42	0.08	0.26	¼	21	Red
	54930BEUF		37/24 = 14.9 kcmil	¼	0.65	0.42	0.08	0.26	¼	21	
	54904BEUF	#6	61/24 = 24.6 kcmil	#10	0.65	0.44	0.08	0.30	¼	24	Blue
	54905BEUF		#6 Flex, 30 Navy	¼	0.65	0.44	0.08	0.30	¼	24	
	54908BEUF	#4	40–50 Navy, #4 Weld	#10	0.65	0.52	0.10	0.37	¼	29	Gray
	54906BEUF		#5, 91/24 = 36.7 kcmil	¼	0.65	0.52	0.10	0.37	¼	29	
	54933BEUF	#2–3	125/24 = 50.4 kcmil	#10	0.65	0.59	0.11	0.41	¼	33	Brown
	54942BEUF		60 Navy, #3 Weld	⅝	0.88	0.59	0.11	0.41	⅜	33	
	54945BEUF	#1	75 Navy, #2 Weld	#10	0.65	0.68	0.11	0.47	¼	37	Green
	54947BEUF		150/24 = 60.5 kcmil	⅝	0.88	0.68	0.11	0.47	⅜	37	
	54946BEUF	1/0	100 Navy	#10	0.65	0.75	0.13	0.52	¼	42	Pink
	54949BEUF		225/24 = 90.8 kcmil	⅝	0.88	0.75	0.13	0.52	⅜	42	
	54909BEUF		#1 Weld	⅜	0.93	0.75	0.13	0.52	⅜	42	
	54950BEUF			½	1.25	0.75	0.13	0.52	½	42	
	54910BEUF	2/0	125 Navy, 1/0 Weld	⅜	0.93	0.83	0.13	0.57	⅜	45	Black
	54951BEUF		275/24 = 111 kcmil	½	1.25	0.83	0.13	0.57	½	45	
	54965BEUF	3/0	325/24 = 131 kcmil, 150 Navy, 2/0 Weld	½	1.25	0.92	0.13	0.63	½	50	Orange
	54970BEUF04	4/0	200 Navy	¼	1.00	1.03	0.14	0.70	¼	54	Purple
	54970BEUF06		450/24 = 182 kcmil	⅜	1.13	1.03	0.14	0.70	⅜	54	
	54970BEUF		3/0 Weld	½	1.25	1.03	0.14	0.70	½	54	
	54913BEUF	250	550/24 = 222 kcmil, 250 Navy, 4/0 Weld	½	1.25	1.13	0.14	0.77	½	62	Yellow
	54914BEUF	300	300 Navy, 250 Weld, 262, 650/24	½	1.25	1.25	0.15	0.85	½	66	White
	54915BEUF	350	–	½	1.25	1.36	0.18	0.93	½	71	Red
	54916BEUF	400	400 Navy, 300 Weld	½	1.25	1.41	0.17	0.96	½	76	Blue
	54917BEUF		775/24 = 313 kcmil, 350, 259 Str.	⅝	1.58	1.41	0.17	0.96	⅝	76	
	54918BEUF	500	925/24 = 373 kcmil	½	1.25	1.61	0.22	1.10	½	87	Brown
	54919BEUF		400 Weld, 350, 3458 Str.	⅝	1.58	1.61	0.22	1.10	⅝	87	
	54921BEUF	600	450 I, K	½	1.25	1.75	0.24	1.20	½	94	Green
	54920BEUF		1100/24 = 444 kcmil	⅝	1.58	1.75	0.24	1.20	⅝	94	
	54922BEUF	750	1325/24 = 535 kcmil	½	1.25	1.94	0.27	1.33	½	106	Black
	54923BEUF		500 Weld	⅝	1.58	1.94	0.27	1.33	⅝	106	
	58984BEUF	–	1600/24 = 646 kcmil	⅝	1.58	1.94	0.27	1.33	⅝	106	
	58926BEUF	900	1925/24 = 777 kcmil	⅝	1.58	2.17	0.31	1.50	⅝	115	Yellow
	54928BEUF	1000	–	⅝	1.58	2.27	0.30	1.55	⅝	125	–
	54928BEUF12			⅞	1.83	2.37	0.30	1.55	⅞	125	

† Contact technical services for specific stranding listings.
Tooling – see pages 104-127. Die selector chart – see pages 128-133.

Compression connectors for copper conductor

One-hole lugs – 90° Long barrel 600 V to 35 kV



Peep holes available – Add suffix PH
Material – High-conductivity wrought copper
Finish – Electro tin plate



One-hole lugs – 90° Long barrel 600 V to 35 kV

Diagrams	Cat. No.	Code (AWG or kcmil)	Wire size Flex class G, H, I, K, M†	Bolt size (in.)	Dimensions (in)					Die code	Die color
					B	C	D	E	F		
	54929BEUB	#8	23 Navy, #8 Flex	#10	0.65	0.42	0.08	0.26	¼	21	Red
	54930BEUB		37/24 = 14.9 kcmil	¼	0.65	0.42	0.08	0.26	¼	21	
	54904BEUB	#6	61/24 = 24.6 kcmil	#10	0.65	0.44	0.08	0.30	¼	24	Blue
	54905BEUB		#6 Flex, 30 Navy	¼	0.65	0.44	0.08	0.30	¼	24	
	54908BEUB	#4	40–50 Navy, #4 Weld	#10	0.65	0.52	0.10	0.37	¼	29	Gray
	54906BEUB		#5, 91/24 = 36.7 kcmil	¼	0.65	0.52	0.10	0.37	¼	29	
	54933BEUB	#2–3	125/24 = 50.4 kcmil	#10	0.65	0.59	0.11	0.41	¼	33	Brown
	54942BEUB		60 Navy, #3 Weld	5/16	0.88	0.59	0.11	0.41	3/8	33	
	54945BEUB	#1	75 Navy, #2 Weld	#10	0.65	0.68	0.11	0.47	¼	37	Green
	54947BEUB		150/24 = 60.5 kcmil	5/16	0.88	0.68	0.11	0.47	3/8	37	
	54946BEUB	1/0	100 Navy	#10	0.65	0.75	0.13	0.52	¼	42	Pink
	54949BEUB		225/24 = 90.8 kcmil	5/16	0.88	0.75	0.13	0.52	3/8	42	
	54909BEUB		#1 Weld	3/8	0.93	0.75	0.13	0.52	3/8	42	
	54950BEUB			½	1.25	0.75	0.13	0.52	½	42	
	54910BEUB	2/0	125 Navy, 1/0 Weld	3/8	0.93	0.83	0.13	0.57	3/8	45	Black
	54951BEUB		275/24 = 111 kcmil	½	1.25	0.83	0.13	0.57	½	45	
	54965BEUB	3/0	325/24 = 131 kcmil, 150 Navy, 2/0 Weld	½	1.25	0.92	0.13	0.63	½	50	Orange
	54970BEUB04	4/0	200 Navy	¼	1.00	1.03	0.14	0.70	¼	54	Purple
	54970BEUB06		450/24 = 182 kcmil	3/8	1.13	1.03	0.14	0.70	3/8	54	
	54970BEUB		3/0 Weld	½	1.25	1.03	0.14	0.70	½	54	
	54913BEUB	250	550/24 = 222 kcmil, 250 Navy, 4/0 Weld	½	1.25	1.13	0.14	0.77	½	62	Yellow
	54914BEUB	300	300 Navy, 250 Weld, 262, 650/24	½	1.25	1.25	0.15	0.85	½	66	White
	54915BEUB	350	–	½	1.25	1.36	0.18	0.93	½	71	Red
	54916BEUB	400	400 Navy, 300 Weld	½	1.25	1.41	0.17	0.96	½	76	Blue
	54917BEUB		775/24 = 313 kcmil, 350, 259 Str.	5/8	1.58	1.41	0.17	0.96	5/8	76	
	54918BEUB	500	925/24 = 373 kcmil	½	1.25	1.61	0.22	1.10	½	87	Brown
	54919BEUB		400 Weld, 350, 3458 Str.	5/8	1.58	1.61	0.22	1.10	5/8	87	
	54921BEUB	600	450 I, K	½	1.25	1.75	0.24	1.20	½	94	Green
	54920BEUB		1100/24 = 444 kcmil	5/8	1.58	1.75	0.24	1.20	5/8	94	
	54922BEUB	750	1325/24 = 535 kcmil	½	1.25	1.94	0.27	1.33	½	106	Black
	54923BEUB		500 Weld	5/8	1.58	1.94	0.27	1.33	5/8	106	
	58984BEUB	–	1600/24 = 646 kcmil	5/8	1.58	1.94	0.27	1.33	5/8	106	
	58926BEUB	900	1925/24 = 777 kcmil	5/8	1.58	2.17	0.31	1.50	5/8	115	Yellow
	54928BEUB	1000	–	5/8	1.58	2.27	0.30	1.55	5/8	125	–
	54928BEUB12			7/8	1.83	2.37	0.30	1.55	7/8	125	

† Contact technical services for specific stranding listings.
 Tooling – see pages 104-127. Die selector chart – see pages 128-133.

Compression connectors for copper conductor

Two-hole lugs – Long barrel 600 V to 35 kV



Peep holes available – Add suffix PH

Material – High-conductivity wrought copper

Finish – Electro tin plate



Two-hole lugs – Long barrel 600 V to 35 kV

Diagrams	Cat. no.	Code (AWG or kcmil)	Wire size Flex class G, H, I, K, M†	Bolt size (in.)	Dimensions (in)							Die code	Die color	
					A	B	C	D	E	F	H			
	54801BE	#14-10	-	1/4	1.86	1.19	0.50	0.05	0.20	1/4	5/8	ERG4002,	"C" nest	
	256-31426-3			#10	2.00	1.25	0.37	0.07	0.20	1/4	5/8	ERG4005		
	256-31426-3SPH			#10	2.00	1.25	0.37	0.07	0.20	7/32	5/8-3/4			
	256-30695-1298			1/4	1.89	1.22	0.50	0.05	0.20	1/4	5/8			
	256-30695-1730			1/4	1.98	1.31	0.50	0.05	0.20	1/4	5/8-3/4			
	54850BE*	#8	37/24 = 14.9 kcmil	1/4	2.19	1.89	0.42	0.07	0.26	1/4	5/8	21	Red	
	54851BE*		#8 Weld	1/4	2.31	1.29	0.47	0.06	0.26	1/4	3/4	21		
	256-30695-1157		23 Navy	3/8	3.00	2.10	0.56	0.06	0.26	3/8	1	21		
		54852BE*	#6	30 Navy	1/4	2.28	1.28	0.44	0.08	0.30	1/4	5/8	24	Blue
		256-30695-1014		61/24 = 24.6 kcmil	1/4	2.63	1.63	0.43	0.08	0.30	1/4	1	24	
256-30695-1225*			#6 Weld	1/4	2.43	1.43	0.43	0.08	0.30	1/4	3/4	24		
256-30695-1158*			#5 Weld	3/8	2.93	1.93	0.59	0.06	0.30	3/8	1	24		
256-30695-868*				1/2	4.18	3.00	0.88	0.11	0.30	1/2	1 3/4	24		
		54854BE*	#4	40-50 Navy	1/4	2.31	1.19	0.52	0.10	0.37	1/4	5/8	29	Gray
		256-30695-1246*		#5, 91/24 = 36.7 kcmil	1/4	2.31	1.31	0.56	0.09	0.37	1/4	3/4	29	
		256-30695-1015		#4 Weld	1/4	2.88	1.88	0.58	0.09	0.37	3/8	1	29	
		256-30695-1337			5/16	2.75	1.75	0.56	0.10	0.37	11/32	1	29	
		256-30695-1159*			3/8	3.13	1.98	0.59	0.09	0.37	3/8	1	29	
		256-30695-733*			1/2	4.18	3.00	0.88	0.09	0.37	1/2	1 3/4	29	
		256-30695-1016	#2-3	60 Navy	1/4	3.06	1.88	0.67	0.09	0.41	3/8	1	33	Brown
		54855BE*		#3 Weld	1/4	2.43	1.28	0.59	0.11	0.41	1/4	5/8	33	
		256-30695-1300*		125/24 = 50.4 kcmil	1/4	2.63	1.35	0.68	0.11	0.41	1/4	3/4	33	
		54856BE*			5/16	2.78	1.63	0.59	0.11	0.41	3/8	3/4	33	
54810BE				3/8	3.80	2.57	0.59	0.11	0.41	3/8	1 3/4	33		
		256-30695-1160*			3/8	3.08	1.94	0.59	0.11	0.41	3/8	1	33	
		256-30695-869			1/2	4.02	2.88	0.75	0.09	0.41	5/8	1 3/4	33	
		54811BE*			1/2	4.28	3.00	0.88	0.11	0.41	1/2	1 3/4	33	
		54809BE	#1	75 Navy	1/4	2.88	1.19	0.67	0.11	0.47	1/4	5/8	37	Green
	54812BE		150/24 = 60.5 kcmil	1/4	2.75	1.40	0.67	0.11	0.47	1/4	3/4	37		
	54858BE		175/24 = 70.6 kcmil,	5/16	2.97	1.63	0.67	0.11	0.47	3/8	7/8	37		
	256-30695-1161		#2 Weld	3/8	3.30	1.98	0.67	0.11	0.47	3/8	1	37		
	54857BE			1/2	4.43	3.00	0.88	0.11	0.47	1/2	1 3/4	37		
		256-30695-1018	1/0	100 Navy	1/4	3.63	1.88	0.75	0.13	0.52	3/8	1	42	Pink
		256-30695-1018P		#1 Weld	1/4	3.63	1.88	0.75	0.13	0.52	3/8	1	42	
54859BE			225/24 = 90.8 kcmil	1/4	2.63	1.19	0.75	0.13	0.52	1/4	5/8	42		
54813BE				1/4	2.71	1.38	0.75	0.13	0.52	1/4	3/4	42		
54860BE				5/16	2.97	1.63	0.75	0.13	0.52	3/8	7/8	42		
		256-30695-1162P			3/8	3.25	1.98	0.75	0.13	0.52	3/8	1	42	
		256-30695-1162			3/8	3.23	1.93	0.75	0.13	0.52	3/8	1	42	
		256-30695-593*			1/2	4.33	3.00	0.75	0.13	0.52	5/8	1 3/4	42	

† Contact technical services for specific stranding listings. * UL† listed for direct-burial applications. Tooling – see pages 104-127. Die selector chart – see pages 128-133.

Compression connectors for copper conductor

Two-hole lugs – Long barrel 600 V to 35 kV (continued)



Peep holes available – Add suffix PH

Material – High-conductivity wrought copper

Finish – Electro tin plate



Two-hole lugs – Long barrel 600 V to 35 kV

Diagrams	Cat. no.	Code (AWG or kcmil)	Wire size Flex class G, H, I, K, M [†]	Bolt size (in.)	Dimensions (in)								Die code	Die color
					A	B	C	D	E	F	H			
	54814BE	2/0	125 Navy	1/4	2.62	1.25	0.83	0.13	0.57	1/4	5/8	45	Black	
	256-30695-1299		275/24 = 111 kcmil	1/4	2.69	1.31	0.81	0.13	0.57	1/4	3/4	45		
	256-30695-1116		1/0 Weld	3/8	3.19	1.81	0.83	0.13	0.57	3/8	1	45		
	256-30695-1116P			3/8	3.19	1.81	0.83	0.13	0.57	3/8	1	45		
	54862BE*				1/2	4.20	2.81	0.83	0.13	0.57	1/2	1 3/4	45	
	54815BE	3/0	2/0 Weld	1/4	2.89	1.45	0.92	0.13	0.63	1/4	3/4	50	Orange	
	54816BE		325/24 = 131 kcmil	3/8	3.25	1.63	0.92	0.13	0.63	3/8	1	50		
	54864BE		150 Navy	1/2	4.48	3.00	0.94	0.13	0.63	1/2	1 3/4	50		
	54817BE	4/0	200 Navy	1/4	3.15	1.38	1.03	0.14	0.70	1/4	3/4	54	Purple	
	54818BE		450/24 = 182 kcmil	3/8	4.38	2.63	1.03	0.14	0.70	3/8	1 3/4	54		
256-30695-1117		3/0 Weld	3/8	3.35	1.81	1.03	0.14	0.70	3/8	1	54			
256-30695-1117P			3/8	3.50	1.88	1.03	0.14	0.70	3/8	1	54			
54866BE*				1/2	4.70	3.00	1.03	0.14	0.70	1/2	1 3/4	54		
	256-30695-1245	250	250 Navy	3/8	3.83	1.93	1.13	0.14	0.77	3/8	1	62	Yellow	
	256-30695-1245P		550/24 = 222 kcmil, 4/0 Weld	3/8	3.83	1.93	1.13	0.14	0.77	3/8	1	62		
	54868BE*				1/2	4.92	3.00	1.13	0.14	0.77	1/2	1 3/4	62	
	54819BE	300	300 Navy	3/8	5.04	2.80	1.25	0.15	0.85	3/8	1	66	White	
	54870BE		250 Weld, 262, 650/24	1/2	5.23	3.00	1.25	0.15	0.85	1/2	1 3/4	66		
	54820BE	350	–	1/4	4.29	1.93	1.36	0.18	0.93	1/4	3/4	71	Red	
	256-30695-1118			3/8	4.33	1.93	1.36	0.18	0.93	3/8	1	71		
	256-30695-1118P			3/8	4.33	1.93	1.36	0.18	0.93	3/8	1	71		
	54872BE			1/2	5.40	3.00	1.36	0.18	0.93	1/2	1 3/4	71		
	54822BE	400	400 Navy	1/4	4.38	1.93	1.41	0.17	0.96	1/4	3/4	76	Blue	
54821BE		775/24 = 313 kcmil	3/8	4.43	1.93	1.41	0.17	0.96	3/8	1	76			
54874BE		300 Flex, 350, 259 Str.	1/2	5.51	3.00	1.41	0.17	0.96	1/2	1 3/4	76			
54823BE	500	400 Weld, G, H, I	1/4	4.93	1.94	1.61	0.22	1.10	1/4	3/4	87	Brown		
256-30695-1119		925/24 = 373 kcmil	3/8	5.00	1.93	1.61	0.22	1.10	3/8	1	87			
256-30695-1119P		350, K	3/8	5.00	1.93	1.61	0.22	1.10	3/8	1	87			
54876BE			1/2	6.00	3.00	1.61	0.22	1.10	1/2	1 3/4	87			
54824BE	600	450, I, K	3/8	5.70	2.80	1.75	0.24	1.20	3/8	1	94	Green		
54878BE		1100/24 = 444 kcmil	1/2	5.83	3.00	1.75	0.24	1.20	1/2	1 3/4	94			
54879BE	700	1325/24 = 535 kcmil	1/2	5.83	3.00	1.80	0.24	1.25	1/2	1 3/4	99	Pink		
256-30695-1222	750	500, G, H, I, K	3/8	5.25	2.06	1.94	0.27	1.33	1/2	1	106	Black		
256-30695-1222P		1325/24 = 535 kcmil	3/8	5.25	2.06	1.94	0.27	1.33	1/2	1	106			
54880BE			1/2	6.20	3.00	1.94	0.27	1.33	1/2	1 3/4	106			
58884BE	–	1600/24 = 646 kcmil	1/2	6.16	3.00	1.94	0.27	1.33	1/2	1 3/4	106			
58826BE	900	1925/24 = 777 kcmil	1/2	6.74	3.00	2.18	0.31	1.50	1/2	1 3/4	115	Yellow		
54826BE	1000	1000 Navy	3/8	6.49	2.80	2.27	0.30	1.55	3/8	1	125	–		
54882BE			1/2	6.66	3.00	2.27	0.30	1.55	3/8	1 3/4	125			
54888BE	1250	929, 2300/24	1/2	7.88	3.00	2.42	0.35	1.67	5/8	1 3/4	140			

[†] Contact technical services for specific stranding listings. * UL[®] listed for direct-burial applications. Tooling – see pages 104-127. Die selector chart – see pages 128-133.

Compression connectors for copper conductor

Two-hole lugs – 45° Long barrel 600 V to 35 kV



Peep holes available – Add suffix PH

Material – High-conductivity wrought copper

Finish – Electro tin plate



Two-hole lugs – 45° Long barrel 600 V to 35 kV

Diagrams	Cat. no.	Code (AWG or kcmil)	Wire size Flex class G, H, I, K, M†	Bolt size (in.)	Dimensions (in)					Die code	Die color			
					B	C	D	E	F			G		
	256-31426-3SPHUF	#14-10	–	#10	1.25	0.37	0.07	0.20	7/32	5/8 – 3/4	ERG4002,	"C" nest ERG4005		
	256-30695-1298UF			1/4	1.22	0.50	0.05	0.20	1/4	5/8				
	256-30695-1055UF			1/4	1.31	0.50	0.13	0.36	1/4	5/8 – 3/4				
	54850BEUF	#8	37/24 = 14.9 kcmil	1/4	1.89	0.42	0.07	0.26	1/4	5/8	21	Red		
	54851BEUF		#8 Weld	1/4	1.29	0.47	0.06	0.26	1/4	3/4	21			
	54851BEUF0612		23 Navy	3/8	1.42	0.47	0.06	0.26	3/8	3/4	21			
		54852BEUF	#6	30 Navy	1/4	1.28	0.44	0.08	0.30	1/4	5/8	24	Blue	
		54852BEUF0416		61/24 = 24.6 kcmil	1/4	1.63	0.43	0.08	0.30	1/4	1	24		
		54852BEUF0412		#6 Weld	1/4	1.43	0.43	0.08	0.30	1/4	3/4	24		
		54852BEUF0616		#5 Weld	3/8	1.93	0.59	0.06	0.30	3/8	1	24		
		54852BEUF0828			1/2	3.00	0.88	0.11	0.30	1/2	1 3/4	24		
		54854BEUF	#4	40-50 Navy	1/4	1.19	0.52	0.10	0.37	1/4	5/8	29		Gray
		54854BEUF0412		#5, 91/24 = 36.7 kcmil	1/4	1.31	0.56	0.09	0.37	1/4	3/4	29		
54854BEUF0416		#4 Weld	1/4	1.88	0.58	0.09	0.37	3/8	1	29				
54854BEUF0516			5/16	1.75	0.56	0.10	0.37	1 1/32	1	29				
54854BEUF0616			3/8	1.98	0.59	0.09	0.37	3/8	1	29				
54854BEUF0828			1/2	3.00	0.88	0.09	0.37	1/2	1 3/4	29				
	54855BEUF0416	#2-3	60 Navy	1/4	1.88	0.67	0.09	0.41	3/8	1	33	Brown		
	54855BEUF		#3 Weld	1/4	1.28	0.59	0.11	0.41	1/4	5/8	33			
	54855BEUF0412		125/24 = 50.4 kcmil	1/4	1.35	0.68	0.11	0.41	1/4	3/4	33			
	54856BEUF			5/16	1.63	0.59	0.11	0.41	3/8	3/4	33			
	54810BEUF			3/8	2.57	0.59	0.11	0.41	3/8	1 3/4	33			
	54810BEUF0616			3/8	1.94	0.59	0.11	0.41	3/8	1	33			
	54811BEUF			1/2	3.00	0.88	0.11	0.41	1/2	1 3/4	33			
	54809BEUF	#1	75 Navy	1/4	1.19	0.67	0.11	0.47	1/4	5/8	37		Green	
54812BEUF		150/24 = 60.5 kcmil	1/4	1.40	0.67	0.11	0.47	1/4	3/4	37				
54858BEUF		175/24 = 70.6 kcmil,	5/16	1.63	0.67	0.11	0.47	3/8	7/8	37				
54857BEUF0616		#2 Weld	3/8	1.98	0.67	0.11	0.47	3/8	1	37				
54857BEUF			1/2	3.00	0.88	0.11	0.47	1/2	1 3/4	37				
54859BEUF0416	1/0	100 Navy	1/4	1.88	0.75	0.13	0.52	3/8	1	42	Pink			
54859BEUF0416PH		#1 Weld	1/4	1.88	0.75	0.13	0.52	3/8	1	42				
54859BEUF		225/24 = 90.8 kcmil	1/4	1.19	0.75	0.13	0.52	1/4	5/8	42				
54813BEUF			1/4	1.38	0.75	0.13	0.52	1/4	3/4	42				
54860BEUF			5/16	1.63	0.75	0.13	0.52	3/8	7/8	42				
54860BEUF0616			3/8	1.98	0.75	0.13	0.52	3/8	1	42				
54860BEUF0616PH			3/8	1.93	0.75	0.13	0.52	3/8	1	42				
54860BEUF0828			1/2	3.00	0.75	0.13	0.52	5/8	1 3/4	42				
	54814BEUF	2/0	125 Navy	1/4	1.25	0.83	0.13	0.57	1/4	5/8	45	Black		
	54814BEUF0412		275/24 = 111 kcmil	1/4	1.31	0.81	0.13	0.57	1/4	3/4	45			
	54862BEUF0616		1/0 Weld	3/8	1.81	0.83	0.13	0.57	3/8	1	45			
	54862BEUF0616PH			3/8	1.81	0.83	0.13	0.57	3/8	1	45			
	54862BEUF			1/2	2.81	0.83	0.13	0.57	1/2	1 3/4	45			

† Contact technical services for specific stranding listings. Tooling – see pages 104-127. Die selector chart – see pages 128-133.

Compression connectors for copper conductor

Two-hole lugs – 45° Long barrel 600 V to 35 kV (continued)



Peep holes available! Add suffix PH.

Material – High-conductivity wrought copper

Finish – Electro tin plate

Two-hole lugs – 45° Long barrel 600 V to 35 kV



Diagrams	Cat. no.	Code (AWG or kcmil)	Wire size Flex class G, H, I, K, M†	Bolt size (in.)	Dimensions (in.)						Die code	Die color		
					B	C	D	E	F	G				
	54815BEUF	3/0	2/0 Weld	1/4	1.45	0.92	0.13	0.63	1/4	3/4	50	Orange		
	54816BEUF		325/24 = 131 kcmil	3/8	1.63	0.92	0.13	0.63	3/8	1	50			
	54864BEUF		150 Navy	1/2	3.00	0.94	0.13	0.63	1/2	1 3/4	50			
		54817BEUF	4/0	200 Navy	1/4	1.38	1.03	0.14	0.70	1/4	3/4	54	Purple	
		54818BEUF		450/24 = 182 kcmil	3/8	2.63	1.03	0.14	0.70	3/8	1 3/4	54		
		54818BEUF0616		3/0 Weld	3/8	1.81	1.03	0.14	0.70	3/8	1	54		
			54818BEUF0616PH			3/8	1.88	1.03	0.14	0.70	3/8	1	54	Yellow
			54866BEUF			1/2	3.00	1.03	0.14	0.70	1/2	1 3/4	54	
			54868BEUF0616	250	250 Navy	3/8	1.93	1.13	0.14	0.77	3/8	1	62	
				54868BEUF0616PH		550/24 = 222 kcmil	3/8	1.93	1.13	0.14	0.77	3/8	1	62
54868BEUF					4/0 Weld	1/2	3.00	1.13	0.14	0.77	1/2	1 3/4	62	
54819BEUF				300	300 Navy	3/8	2.80	1.25	0.15	0.85	3/8	1	66	
				54870BEUF		250 Weld, 262, 650/24	1/2	3.00	1.25	0.15	0.85	1/2	1 3/4	66
	54820BEUF			350	–	1/4	1.93	1.36	0.18	0.93	1/4	3/4	71	
	54872BEUF0616					3/8	1.93	1.36	0.18	0.93	3/8	1	71	
				54872BEUF0616PH			3/8	1.93	1.36	0.18	0.93	3/8	1	71
		54872BEUF				1/2	3.00	1.36	0.18	0.93	1/2	1 3/4	71	
		54822BEUF		400	400 Navy	1/4	1.93	1.41	0.17	0.96	1/4	3/4	76	
				54821BEUF		775/24 = 313 kcmil	3/8	1.93	1.41	0.17	0.96	3/8	1	76
			54874BEUF			1/2	3.00	1.41	0.17	0.96	1/2	1 3/4	76	
			54823BEUF	500	400 Weld, G, H, I	1/4	1.94	1.61	0.22	1.10	1/4	3/4	87	
				54876BEUF0616		925/24 = 373 kcmil	3/8	1.93	1.61	0.22	1.10	3/8	1	87
54876BEUF0616PH					350, K	3/8	1.93	1.61	0.22	1.10	3/8	1	87	
54876BEUF						1/2	3.00	1.61	0.22	1.10	1/2	1 3/4	87	
				54824BEUF	600	450 Weld, I, K	3/8	2.80	1.75	0.24	1.20	3/8	1	94
	54878BEUF				1100/24 = 444 kcmil	1/2	3.00	1.75	0.24	1.20	1/2	1 3/4	94	
	54880BEUF0616			750	500, G, H, I, K	3/8	2.06	1.94	0.27	1.33	1/2	1	106	
				54880BEUF0616PH		1325/24 = 535 kcmil	3/8	2.06	1.94	0.27	1.33	1/2	1	106
		54880BEUF				1/2	3.00	1.94	0.27	1.33	1/2	1 3/4	106	
		58884BEUF		–	1600/24 = 646 kcmil	1/2	3.00	1.94	0.27	1.33	1/2	1 3/4	106	
				58826BEUF	900	1925/24 = 777 kcmil	1/2	3.00	2.18	0.31	1.50	1/2	1 3/4	115
			54826BEUF	1000	1000 Navy	3/8	2.80	2.27	0.30	1.55	3/8	1	125	
			54882BEUF			1/2	3.00	2.27	0.30	1.55	1/2	1 3/4	125	

† Contact technical services for specific stranding listings. Tooling – see pages 104-127. Die selector chart – see pages 128-133.

Compression connectors for copper conductor

Two-hole lugs – 90° Long barrel 600 V to 35 kV



Peep holes available! Add suffix PH.

Material – High-conductivity wrought copper

Finish – Electro tin plate

Two-hole lugs – 90° Long barrel 600 V to 35 kV



Diagrams	Cat. no.	Code (AWG or kcmil)	Wire size Flex class G, H, I, K, M†	Bolt size (in.)	Dimensions (in.)					Die code	Die color		
					B	C	D	E	F			G	
	56-31426-3SPHUB	#14-10	–	#10	1.25	0.37	0.07	0.20	7/32	5/8-3/4	ERG4002,	"C" nest	
	256-30695-1298UB			1/4	1.22	0.50	0.05	0.20	1/4	5/8	ERG4005		
	256-30695-1055UB			1/4	1.31	0.50	0.13	0.36	1/4	5/8-3/4			
		54850BEUB	#8	37/24 = 14.9 kcmil	1/4	1.89	0.42	0.07	0.26	1/4	13/16	21	Red
		54851BEUB		#8 Weld	1/4	1.29	0.47	0.06	0.26	1/4	3/4	21	
		54851BEUB0616		23 Navy	3/8	2.10	0.56	0.06	0.26	3/8	1	21	
		54852BEUB	#6	30 Navy	1/4	1.28	0.44	0.08	0.30	1/4	5/8	24	Blue
		256306951014B		61/24 = 24.6 kcmil	1/4	1.63	0.43	0.08	0.30	1/4	1	24	
		54852BEUB0412		#6 Weld	1/4	1.43	0.43	0.08	0.30	1/4	3/4	24	
		54852BEUB0616			3/8	1.93	0.59	0.06	0.30	3/8	1	24	
54852BEUB0828				1/2	3.00	0.88	0.11	0.30	1/2	1 3/4	24		
54854BEUB		#4	40-50 Navy	1/4	1.19	0.52	0.10	0.37	1/4	5/8	29	Gray	
54854BEUB0412			#5, 91/24 = 36.7 kcmil	1/4	1.31	0.56	0.09	0.37	1/4	3/4	29		
54854BEUB0416		#4 Weld	1/4	1.88	0.58	0.09	0.37	3/8	1	29			
54854BEUB0516			5/16	1.75	0.56	0.10	0.37	11/32	1	29			
54854BEUB0616			3/8	1.98	0.59	0.09	0.37	3/8	1	29			
54854BEUB0828			1/2	3.00	0.88	0.09	0.37	1/2	1 3/4	29			
54858BEUB0416	#2-3	60 Navy	1/4	1.88	0.67	0.09	0.41	3/8	1	33	Brown		
54855BEUB		#3 Weld	1/4	1.28	0.59	0.11	0.41	1/4	5/8	33			
54855BEUB0412		125/24 = 50.4 kcmil	1/4	1.35	0.68	0.11	0.41	1/4	3/4	33			
54856BEUB			5/16	1.63	0.59	0.11	0.41	3/8	3/4	33			
54810BEUB			3/8	2.57	0.59	0.11	0.41	3/8	1 3/4	33			
54810BEUB0616			3/8	1.94	0.59	0.11	0.41	3/8	1	33			
54811BEUB			1/2	3.00	0.88	0.11	0.41	1/2	1 3/4	33			
54809BEUB	#1	75 Navy	1/4	1.19	0.67	0.11	0.47	1/4	5/8	37	Green		
54812BEUB		150/24 = 60.5 kcmil	1/4	1.40	0.67	0.11	0.47	1/4	3/4	37			
54858BEUB		175/24 = 70.6 kcmil	5/16	1.63	0.67	0.11	0.47	3/8	7/8	37			
54857BEUB0616		#2 Weld	3/8	1.98	0.67	0.11	0.47	3/8	1	37			
54857BEUB			1/2	3.00	0.88	0.11	0.47	1/2	1 3/4	37			
54859BEUB0416			1/4	1.88	0.75	0.13	0.52	3/8	1	42			
54859BEUB0416PH		#1 Weld	1/4	1.88	0.75	0.13	0.52	3/8	1	42	Pink		
54859BEUB		225/24 = 90.8 kcmil	1/4	1.19	0.75	0.13	0.52	1/4	5/8	42			
54813BEUB			1/4	1.38	0.75	0.13	0.52	1/4	3/4	42			
54860BEUB			5/16	1.63	0.75	0.13	0.52	3/8	7/8	42			
54860BEUB0616			3/8	1.98	0.75	0.13	0.52	3/8	1	42			
54860BEUB0828			1/2	3.00	0.75	0.13	0.52	5/8	1 3/4	42			
54814BEUB	2/0	125 Navy	1/4	1.25	0.83	0.13	0.57	1/4	5/8	45	Black		
54814BEUB0412		275/24 = 111 kcmil	1/4	1.31	0.81	0.13	0.57	1/4	3/4	45			
54862BEUB0616		1/0 Weld	3/8	1.81	0.83	0.13	0.57	3/8	1	45			
54862BEUB0616PH			3/8	1.81	0.83	0.13	0.57	3/8	1	45			
54862BEUB			1/2	2.81	0.83	0.13	0.57	1/2	1 3/4	45			

† Contact technical services for specific stranding listings. Tooling – see pages 104-127. Die selector chart – see pages 128-133.

Compression connectors for copper conductor

Two-hole lugs – 90° Long barrel 600 V to 35 kV (continued)



Peep holes available! Add suffix PH.

Material – High-conductivity wrought copper

Finish – Electro tin plate



Two-hole lugs – 90° Long barrel 600 V to 35 kV

Cat. no.	Code (AWG or kcmil)	Wire size Flex class G, H, I, K, M*	Bolt size (in.)	Dimensions (in.)						Die code	Die color
				B	C	D	E	F	G		
54815BEUB	3/0	150 Navy	1/4	1.45	0.92	0.13	0.63	1/4	3/4	50	Orange
54816BEUB		2/0 Weld	3/8	1.63	0.92	0.13	0.63	3/8	3/4	50	
54864BEUB		325/24 = 131 kcmil	1/2	3.00	0.94	0.13	0.63	1/2	1 3/4	50	
54817BEUB	4/0	200 Navy	1/4	1.38	1.03	0.14	0.70	1/4	3/4	54	Purple
54818BEUB		450/24 = 182 kcmil	3/8	2.63	1.03	0.14	0.70	3/8	1 3/4	54	
54818BEUB0616		3/0 Weld	3/8	1.81	1.03	0.14	0.70	3/8	1	54	
54818BEUB0616PH			3/8	1.88	1.03	0.14	0.70	3/8	1	54	
54866BEUB			1/2	3.00	1.03	0.14	0.70	1/2	1 3/4	54	
54868BEUB0616	250	250 Navy	3/8	1.93	1.13	0.14	0.77	3/8	1	62	Yellow
54868BEUB0616PH		550/24 = 222 kcmil	3/8	1.93	1.13	0.14	0.77	3/8	1	62	
54868BEUB		4/0 Weld	1/2	3.00	1.13	0.14	0.77	1/2	1 3/4	62	
54819BEUB	300	300 Navy	3/8	2.80	1.25	0.15	0.85	3/8	1	66	White
54870BEUB		250 Weld, 26, 2, 650/24	1/2	3.00	1.25	0.15	0.85	1/2	1 3/4	66	
54820BEUB	350	–	1/4	1.93	1.36	0.18	0.93	1/4	3/4	71	Red
54872BEUB0616			3/8	1.93	1.36	0.18	0.93	3/8	1	71	
54872BEUB0616PH			3/8	1.93	1.36	0.18	0.93	3/8	1	71	
54872BEUB			1/2	3.00	1.36	0.18	0.93	1/2	1 3/4	71	
54822BEUB	400	400 Navy	1/4	1.93	1.41	0.17	0.96	1/4	3/4	76	Blue
54821BEUB		775/24 = 313 kcmil	3/8	1.93	1.41	0.17	0.96	3/8	1	76	
54874BEUB		300 Weld, 350, 259 Str.	1/2	3.00	1.41	0.17	0.96	1/2	1 3/4	76	
54823BEUB	500	400 Weld, G, H, I	1/4	1.94	1.61	0.22	1.10	1/4	3/4	87	Brown
54823BEUB0616		925/24 = 373 kcmil	3/8	1.93	1.61	0.22	1.10	3/8	1	87	
54876BEUB0616PH		350, K	3/8	1.93	1.61	0.22	1.10	3/8	1	87	
54876BEUB			1/2	3.00	1.61	0.22	1.10	1/2	1 3/4	87	
54824BEUB	600	450 Weld, I, K	3/8	2.80	1.75	0.24	1.20	3/8	1	94	Green
54878BEUB		1100/24 = 444 kcmil	1/2	3.00	1.75	0.24	1.20	1/2	1 3/4	94	
54880BEUB0616	750	500, G, H, I, K	3/8	2.06	1.94	0.27	1.33	1/2	1	106	Black
54880BEUB0616PH		1325/24 = 535 kcmil	3/8	2.06	1.94	0.27	1.33	1/2	1	106	
54880BEUB			1/2	3.00	1.94	0.27	1.33	1/2	1 3/4	106	
58884BEUB	–	1600/24 = 646 kcmil	1/2	3.00	1.94	0.27	1.33	1/2	1 3/4	106	Yellow
58826BEUB	900	1925/24 = 777 kcmil	1/2	3.00	2.18	0.31	1.50	1/2	1 3/4	115	
54826BEUB	1000	1000 Navy	3/8	2.80	2.27	0.30	1.55	3/8	1	125	–
54882BEUB			3/8	3.00	2.27	0.30	1.55	1/2	1 3/4	125	

Diagrams

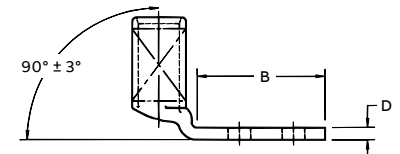
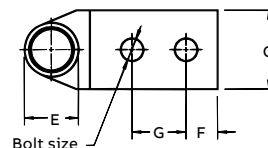

Compression connectors for copper conductor

Copper one-hole lugs for 600 V to 35 kV Applications



These connectors are recommended for up to 15 kV applications. Installed with standard T&B Cat. No. TBM15I, 13100A, TBM14M hydraulic compression tools with special rounding dies. The compression forms the connector and conductor into a solid mass to provide an optimum electrical bond between connector and conductor. The rounding die-overlapped compressions provide a smooth, round surface. This, combined with the tapered barrel ends, addresses the controlling of potentially damaging electrical stresses of high voltages.

Copper one-hole lugs for 600 V to 35 kV applications



Cat. no.	Cable size [†] (AWG or kcmil)	Stud size (in.)	Dimensions (in.)						Installing tools		
			A	B	C	D	E	F	Die set Cat. no.	Strip length (in.)	Color code
54440	#4	3/8	2.08	0.81	0.58	0.08	3/8	1/2	15CA29R	1 7/16	Gray
54443	#2	3/8	2.25	0.81	0.66	0.09	3/8	1/2	15CA33R	1 7/16	Brown
54448	#1	3/8	2.36	0.81	0.69	0.10	3/8	1/2	15CA37R	1 19/32	Green
54409	1/0	3/8	2.38	0.81	0.75	0.12	3/8	1/2	15CA42R	1 5/8	Pink
54460	2/0	1/2	2.73	1.06	0.83	0.12	1/2	1/2	15CA45R	1 5/8	Black
54465	3/0	1/2	2.81	1.06	0.94	0.12	1/2	1/2	15CA49R	1 3/4	Orange
54470	4/0	1/2	2.78	1.06	1.00	0.13	1/2	1/2	15CA54R	1 13/16	Purple
54413	250	1/2	3.19	1.06	1.07	0.14	1/2	1/2	15CA60R	2 1/32	Ruby

Diagrams

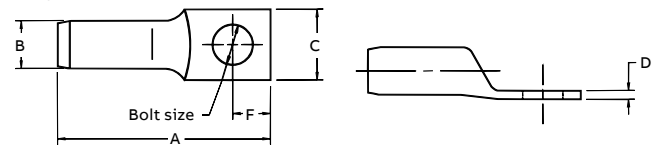

[†] Cable size: concentric and compact strandings.
 * Cat. no. TB15500 die adapter required for TBM15I.
 Tooling – see pages 104-127.
 Die selector chart – see pages 128-133.

Compression connectors for copper conductor

Copper two-hole lugs for 600 V to 35 kV applications



These connectors are recommended for up to 15 kV applications. Installed with standard T&B Cat. No. TBM15I, 13100A, TBM14M hydraulic compression tools with special rounding dies. The compression forms the connector and conductor into a solid mass to provide an optimum electrical bond between connector and conductor. The rounding die-overlapped compressions provide a smooth, round surface. This, combined with the tapered barrel ends, addresses the controlling of potentially damaging electrical stresses of high voltages.

Copper two-hole lugs for 600 V to 35 kV applications



Cat. no.	Cable size* (AWG or kcmil)	Stud size (in.)	Dimensions (in.)							Installing tools		
			A	B	C	D	E	F	G	Die set Cat. no.	Strip length (in.)	Color code
54475	1/0	3/8	3.56	17/32	0.77	0.12	3/8	3/8	1.00	15CA42R	1 5/8	Pink
54476	2/0	1/2	4.67	9/16	0.83	0.12	1/2	1/2	1.75	15CA45R	1 5/8	Black
54478	3/0	1/2	4.75	5/8	0.94	0.12	1/2	1/2	1.75	15CA49R	1 3/4	Orange
54479	4/0	1/2	4.64	11/16	1.00	0.13	1/2	1/2	1.75	15CA54R	1 13/16	Purple
54480	250	1/2	5.17	3/4	1.08	0.14	1/2	1/2	1.75	15CA60R	2 1/32	Ruby
54481	300	1/2	5.16	13/16	1.19	0.16	1/2	1/2	1.75	15CA66R	2 3/32	White
54482	350	1/2	5.35	7/8	1.29	0.19	1/2	1/2	1.75	15CA71R	2 13/32	Red
54483	400	1/2	5.35	59/64	1.36	0.18	1/2	1/2	1.75	15CA76R	2 13/32	Blue
54484	500	1/2	5.60	1 1/16	1.54	0.23	1/2	1/2	1.75	15CA87R	2 13/32	Brown
54485	600	1/2	5.83	1 11/64	1.70	0.24	1/2	1/2	1.75	15CA94R	2 9/16	Green
54487	750	1/2	6.13	1 19/64	1.89	0.27	1/2	1/2	1.75	15CA106R	2 3/4	Black
54490	1000	1/2	6.60	1 1/2	2.18	0.31	1/2	1/2	1.75	15C125R*	2 29/32	-

Diagrams

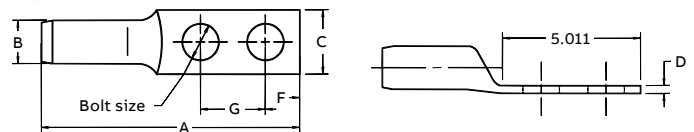

* No adapter required – TBM15I only.

† Cable size: concentric and compact strandings.

TBM14M and 13100A UL listing limited to 1/0 AWG–500 kcmil cable sizes.

* Cat. no. TB15500 die adapter required for TBM15I.

Tooling – see pages 104-127.

Die selector chart – see pages 128-133.

Compression connectors for copper conductor

Bell-ended lugs – Standard barrel



Bell-shaped barrel



Cat. no.	Wire size (AWG or kcmil)			Class					Bolt size (in.)	Dimensions (in.)					Die code	Die color
	Code	Navy	Flex	G	H	I	K	M		A	B	C	D	F		
54104BS	#8	23	37/24	8	8	–	8	8	#10	1 1/16	15/32	13/32	5/64	7/32	21	Red
54105BS	#6	30	61/24	5	5	5	5	5	1/4	1 3/16	9/16	7/16	7/64	1/4	24	Blue
54106BS	#4	40–50	91/24	5	5	5	5	5	1/4	1 9/32	9/16	9/16	7/64	1/4	29	Gray
54139BS	#3 & 4	40–50	91/24	4	4	4	4	4	5/16	1 7/16	25/32	19/32	5/64	11/32	29	–
54142BS	#2	60	125/24	3	3	3	3	3	5/16	1 17/32	23/32	21/32	5/64	11/32	33	Brown
54147BS	#1	75	150, 175/24	2	2	2	2	2	5/16	1 21/23	23/32	43/64	1/8	3/8	37	Green
54153BS	1/0	100	225/24	1	1	1	1	1	5/16	1 5/8	23/32	3/4	9/64	3/8	42	Pink
54110BS	2/0	125	275/24	1/0	1/0	1/0	1/0	1/0	3/8	1 7/8	13/16	13/16	9/64	3/8	45	Black
54165BS	3/0	150	325/24	2/0	2/0	2/0	2/0	2/0	1/2	2 7/32	1 1/16	15/16	9/64	1/2	50	Orange
54170BS	4/0	200	450/24	3/0	3/0	3/0	3/0	3/0	1/2	2 5/16	1 1/16	1 1/2	5/32	1/2	54	Purple
58165BS	250	–	550/24	4/0	4/0	–	–	–	1/2	2 15/32	1 1/8	1 1/4	3/16	1/2	62	Yellow
54114BS	300	300	–	250	250	4/0	4/0	4/0	1/2	2 3/8	1 1/8	1 1/4	3/16	1/2	66	White
54152BS	350	350	650/24	–	–	250	250	250	1/2	2 5/8	1 3/16	1 3/8	13/64	9/16	66	–
54185BS	400	400	775/24	300	300	300	300	300	5/8	3 7/16	1 11/16	1 13/32	7/32	13/16	76	Blue
58177BS	500	–	925/24	400	400	400	350	350	1/2	3	1 5/16	1 5/8	1/4	13/16	80	–
58180BS	600	–	1100/24	–	–	450	450	450	5/8	3 5/8	1 11/16	1 25/32	17/64	13/16	94	Green
54122BS	700	–	1325/24	500	500	500	500	500	5/8	3 5/8	1 11/16	1 25/32	9/32	13/16	99	Pink
54123BS	750	–	–	600	–	–	–	550	5/8	3 5/8	1 11/16	1 15/16	5/16	13/16	106	Black
54124BS	800	800	–	–	–	–	600	–	5/8	3 13/16	1 11/16	2	5/16	5/8	107	Orange
54126BS	900	–	1925/24	–	–	–	–	–	5/8	4 1/8	1 13/16	2 3/16	11/32	7/8	115	Yellow

Diagrams

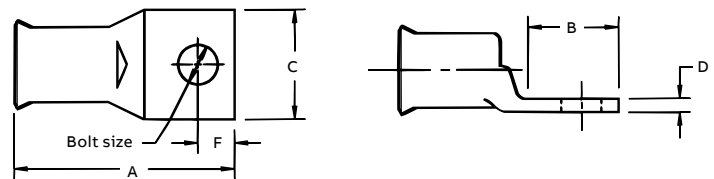

Tooling – see pages 104-127.
Die selector chart – see pages 128-133.

Compression connectors for copper conductor

Bell-ended lugs – Long barrel



Bell-shaped copper lugs with two bolt holes



Cat. no.	Wire size (AWG or kcmil)			Class					Bolt size (in.)	Dimensions (in.)							Die code	Die color
	Code	Navy	Flex	G	H	I	K	M		A	B	C	D	E	F	G		
54850BEBS	#8	23	8	8	8	-	8	-	¼	2.19	1.88	0.42	0.07	0.26	0.25	0.63	21	Red
54851BEBS									¼	2.31	1.29	0.47	0.06	0.26	0.25	0.75	21	
54851BE0616BS									¾	3.00	2.10	0.56	0.06	0.26	0.38	1.00	21	
54852BE0616BS	#6	30	6	5	5	5	5	-	¾	2.93	1.93	0.59	0.06	0.30	0.38	1.00	24	Blue
54852BEBS									¼	2.28	1.28	0.44	0.08	0.30	0.25	0.63	24	
54852BE0412BS									¼	2.43	1.43	0.43	0.07	0.30	0.25	0.75	24	
54854BEBS	#4-3	40-50	5	5	5	5	5	-	¼	2.31	1.19	0.52	0.10	0.37	0.25	0.63	29	Gray
54854BE0412BS									¼	2.31	1.31	0.56	0.09	0.37	0.25	0.75	29	
54854BE0616BS									¾	3.13	1.98	0.59	0.09	0.37	0.38	1.00	29	
54855BE0412BS	#2	60	3	3	3	3	3	3	¼	2.63	1.35	0.68	0.11	0.41	0.25	0.75	33	Brown
54855BEBS									¼	2.43	1.28	0.59	0.11	0.41	0.25	0.63	33	
54856BEBS									3/16	2.78	1.63	0.59	0.11	0.41	0.38	0.75	33	
54810be0616BS									¾	3.08	1.94	0.59	0.11	0.41	0.38	1.00	33	
54811BEBS									½	4.28	3.00	0.88	0.09	0.41	0.50	1.75	33	
54809BEBS	#1	75	2	2	2	2	2	2	¼	2.88	1.19	0.67	0.11	0.47	0.25	0.63	37	Green
54812BEBS									¼	2.75	1.40	0.67	0.11	0.47	0.25	0.75	37	
54858BEBS									5/16	2.97	1.63	0.67	0.11	0.47	0.38	0.88	37	
54857BEBS									½	4.43	3.00	0.88	0.10	0.47	0.50	1.75	37	
54859BEBS	1/0	100	1	1	1	1	1	1	¼	2.63	1.19	0.75	0.13	0.52	0.25	0.63	42	Pink
54813BEBS									¼	2.71	1.38	0.75	0.13	0.52	0.25	0.75	42	
54860BEBS									5/16	2.97	1.63	0.75	0.13	0.52	0.38	0.88	42	
54860BE0616BS									¾	3.23	1.93	0.75	0.13	0.52	0.38	1.00	42	
5414BEBS	2/0	125	1/0	1/0	1/0	1/0	1/0	1/0	¼	2.62	1.25	0.83	0.13	0.57	0.25	0.63	45	Black
54814BE0412BS									¼	2.69	1.31	0.81	0.13	0.57	0.25	0.75	45	
54862BE0616BS									¾	3.19	1.81	0.83	0.13	0.57	0.38	1.00	45	
54862BEBS									½	4.20	2.81	0.83	0.13	0.57	0.50	1.75	45	
54815BEBS	3/0	150	2/0	2/0	2/0	2/0	2/0	2/0	¼	2.89	1.45	0.92	0.13	0.63	0.25	0.75	50	Orange
54816BEBS									¾	3.25	1.63	0.92	0.13	0.63	0.38	1.00	50	
54864BEBS									½	4.45	3.00	0.92	0.13	0.63	0.50	1.75	50	
54817BEBS	4/0	200	3/0	3/0	3/0	3/0	3/0	3/0	¼	3.15	1.38	1.03	0.14	0.70	0.50	0.75	54	Purple
54818BE0616BS									¾	3.35	1.81	1.03	0.14	0.70	0.25	1.00	54	
54818BEBS									¾	4.38	2.63	1.03	0.14	0.70	0.38	1.75	54	
54866BEBS									½	4.70	3.00	1.03	0.14	0.70	0.50	1.75	54	
54868BE0616BS	250	-	4/0	4/0	4/0	4/0	4/0	4/0	¾	3.83	1.93	1.13	0.14	0.77	0.50	1.00	62	Yellow
54868BEBS									½	4.92	3.00	1.13	0.14	0.77	0.50	1.75	62	
54819BEBS	300	300	262	250	250	250	250	-	¾	5.04	2.80	1.25	0.15	0.85	0.50	1.00	66	White
54870BEBS									½	5.23	3.00	1.25	0.15	0.85	0.50	1.75	66	

Tooling – see pages 104-127.

Die selector chart – see pages 128-133.

Compression connectors for copper conductor

Bell-ended lugs – Long barrel (continued)



Bell-shaped copper lugs with two bolt holes



Cat. no.	Wire size (AWG or kcmil)			Class					Bolt size (in.)	Dimensions (in.)							Die code	Die color
	Code	Navy	Flex	G	H	I	K	M		A	B	C	D	E	F	G		
54822BEBS	400	400	313	300	300	300	300	-	1/4	4.38	1.93	1.41	0.17	0.96	0.63	0.75	76	Blue
54821BEBS									3/8	4.43	1.93	1.41	0.17	0.96	0.63	1.00	76	
54874BEBS									1/2	5.51	3.00	1.41	0.17	0.96	0.63	1.75	76	
54823BEBS	500	-	373	400	400	400	350	-	1/4	4.93	1.94	1.61	0.22	1.10	0.50	0.75	87	Brown
54876BE0616BS									3/8	5.00	1.93	1.61	0.22	1.10	0.50	1.00	87	
54876BEBS									1/2	6.00	3.00	1.61	0.22	1.10	0.50	1.75	87	
54824BEBS	-	-	444	-	-	450	450	-	3/8	5.70	2.80	1.75	0.24	1.20	0.63	1.00	94	Green
54878BEBS									1/2	5.83	3.00	1.75	0.24	1.20	0.63	1.75	94	
54880BEBS	700	-	535	500	500	500	500	-	1/2	6.20	3.00	1.94	0.27	1.33	0.63	1.75	106	Black
58826BEBS	900	-	777	-	-	-	-	-	1/2	6.49	2.80	2.27	0.30	1.50	0.63	1.75	115	Yellow

Diagrams

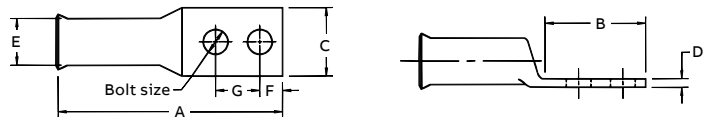

Tooling – see pages 104-127.
Die selector chart – see pages 128-133.

Compression connectors for copper conductor

Two-barrel lugs for 600 V to 35 kV applications



Material – High-conductivity wrought copper
Finish – Electro tin plate



Two-barrel lugs for 600 V to 35 kV applications

Cat. no.	Wire size (AWG or kcmil)		Hole size (in.)	Fig. no.	Dimensions (in.)			Die code	Color key
	Code	Flex			A	W	T		
256-30695-828	#6	61/24	1/4	1	2 ¹⁵ / ₁₆	7/16	1/16	24	Blue
256-30695-1227				2	3 ³ / ₈	7/16	1/16	24	

Diagrams

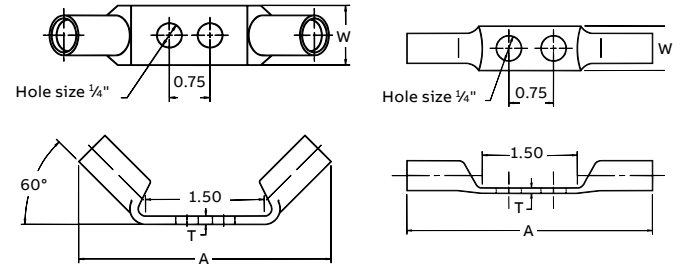

Figure 1

Figure 2

Tooling – see pages 104-127.
 Die selector chart – see pages 128-133.

Compression connectors for copper conductor

Cast copper one-hole lugs for 600 V to 35 kV applications – Heavy duty



Material – Cast copper
Finish – Electro tin plate



Cast copper one-hole lugs for 600 V to 35 kV applications – Heavy duty

Cat. no.	Cable size (AWG or kcmil)	Dimensions (in.)					Bolt size (in.)	Die code
		A	B	C	D	F		
53104	#8	1 ⁷ / ₁₆	³ / ₄	¹ / ₂	¹ / ₈	⁹ / ₃₂	#10	29
53105	#6	1 ⁷ / ₁₆	³ / ₄	¹ / ₂	¹ / ₈	⁹ / ₃₂	¹ / ₄	29
53106	#4	1 ⁷ / ₁₆	³ / ₄	¹ / ₂	¹ / ₈	⁹ / ₃₂	¹ / ₄	29
53107	#2	2	1	³ / ₄	¹ / ₄	⁷ / ₁₆	¹ / ₄	45
53108	#1	2	1	³ / ₄	¹ / ₄	⁷ / ₁₆	¹ / ₄	45
53109	1/0	2	1	³ / ₄	¹ / ₄	⁷ / ₁₆	³ / ₈	45
53161*	325/24	2 ³ / ₁₆	³ / ₄	1 ¹³ / ₁₆	⁷ / ₃₂	⁷ / ₁₆	³ / ₈	54
53110	2/0	2 ⁵ / ₈	1 ¹ / ₄	1	⁹ / ₃₂	1 ¹⁷ / ₃₂	³ / ₈	66
53111	3/0	2 ⁵ / ₈	1 ¹ / ₄	1	⁹ / ₃₂	1 ¹⁷ / ₃₂	³ / ₈	66
53112	4/0	2 ⁵ / ₈	1 ¹ / ₄	1	⁹ / ₃₂	1 ¹⁷ / ₃₂	³ / ₈	66
53165*	650/24	3 ¹ / ₁₆	1 ³ / ₈	1 ³ / ₁₆	⁵ / ₁₆	³ / ₄	¹ / ₂	76
53113	250	3 ¹ / ₁₆	1 ¹ / ₂	1 ³ / ₁₆	⁵ / ₁₆	³ / ₄	¹ / ₂	76
53114	300	3 ¹ / ₁₆	1 ¹ / ₂	1 ³ / ₁₆	⁵ / ₁₆	³ / ₄	¹ / ₂	76
53115	350	3 ¹³ / ₁₆	2	1 ³ / ₈	³ / ₈	1 ¹³ / ₁₆	¹ / ₂	99
53116	400	3 ¹³ / ₁₆	2	1 ³ / ₈	³ / ₈	1 ¹³ / ₁₆	¹ / ₂	99
53118	500	3 ¹³ / ₁₆	2	1 ³ / ₈	³ / ₈	1 ¹³ / ₁₆	¹ / ₂	99
53168*	1100/24	3 ¹⁵ / ₁₆	1 ⁵ / ₈	1 ⁵ / ₈	1 ¹³ / ₃₂	⁷ / ₈	¹ / ₂	107
53169*	1325/24	3 ⁵ / ₁₆	1 ⁵ / ₈	1 ⁵ / ₈	1 ¹³ / ₃₂	⁷ / ₈	¹ / ₂	107
53123	750	4 ³ / ₁₆	2 ¹ / ₈	1 ⁵ / ₈	⁷ / ₁₆	1	¹ / ₂	112
53173*	2750/24	5 ¹ / ₁₆	1 ⁷ / ₈	2 ¹ / ₈	⁹ / ₁₆	1 ³ / ₁₆	¹ / ₂	150

Diagrams

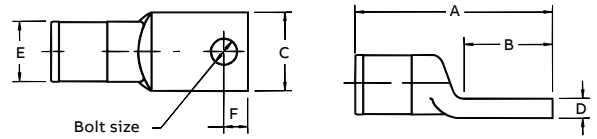

All other cat. nos.: Use hydraulic tools with hex dies.

* No UL/CSA

Tooling – see pages 104-127.

Die selector chart – see pages 128-133.

Compression connectors for copper conductor

Cast copper two-hole lugs for code copper cable 600 V to 35 kV



Material – Cast copper
Finish – Electro tin plate

Cast copper two-hole lugs for code copper cable 600 V to 35 kV



Cat. no.	Code cable size (AWG or kcmil)	Bolt G size (in.)	Dimensions (in.)								No. of crimps			
			A Approx.	B	C	D	E	F	H	Die code	12 Ton	15 Ton	40 Ton	
Diagrams	256-30695-1055	#14-10	1/4	2	1 5/16	1/2	1/8	3/8	1/4	5/8-3/4	29	1	1	1
	53204	#8	1/4	2	1 5/16	1/2	3/32*	3/8	1/4	5/8	29	1	1	1
	53205	#8	1/4	2	1 5/16	1/2	1/8	3/8	1/4	5/8	29	1	1	1
	53206	#4	1/4	2	1 5/16	1/2	1/8	3/8	1/4	5/8	29	1	1	1
	53207	#2	1/4	3	2	3/4	1/8	1 9/32	1/2	3/4	45	1	1	1
	53208	#1	1/4	3	2	3/4	1/4	1 9/32	1/2	1	45	1	1	1
	53209	1/0	3/8	3	2	3/4	1/4	1 9/32	1/2	1	45	1	1	1
	53210	2/0	3/8	4 5/16	3	3/4	3/16*	2 7/32	5/8	1 3/4	66	1	1	1
	53211	3/0	1/2	4 5/16	3	1	9/32	2 7/32	5/8	1 3/4	66	1	1	1
	53212	4/0	1/2	4 5/16	3	1	9/32	2 7/32	5/8	1 3/4	66	1	1	1
	53213	250	1/2	4 9/16	3	1 3/16	3/16*	1 5/16	5/8	1 3/4	76	1	1	1
	53214	300	1/2	4 9/16	3	1 3/16	5/16	1 5/16	5/8	1 3/4	76	1	1	1
	53215	350	1/2	5 5/16	3 1/2	1 3/8	1/4*	1 7/32	5/8	1 3/4	99	2	1	1
	53216	400	1/2	5 5/16	3 1/2	1 3/8	3/8	1 7/32	5/8	1 3/4	99	2	1	1
	53218	500	1/2	5 5/16	3 1/2	1 3/8	3/8	1 7/32	5/8	1 3/4	99	2	1	1
	53220M	600	1/2	5 5/16	3 1/2	1 5/8	1 7/32	1 2 3/64	5/8	1 3/4	112	2	1	1
	53222M	700	1/2	5 5/16	3 1/2	1 5/8	± 1/32	1 2 3/64	5/8	1 3/4	112	2	1	1
	53223M	750	1/2	5 5/16	3 1/2	1 5/8	± 1/32	1 2 3/64	5/8	1 3/4	112	2	1	1
	53269	1325/24	1/2	5 1/2	3 1/2	1 5/8	1 3/32	1 3/8	5/8	1 3/4	107	2	1	1
	53224	800	1/2	6	3 1/2	1 7/8	5/16*	1 9/16	5/8	1 3/4	130	-	1	1
	53226	900	1/2	6	3 1/2	1 7/8	1 5/32	1 9/16	5/8	1 3/4	130	-	1	1
	53228	1000	1/2	6	3 1/2	1 7/8	1 5/32	1 9/16	5/8	3/4	130	-	1	1
	53273	1111	1/2	6 3/16	3 1/2	2 1/8	9/16	1 2 9/32	5/8	1 3/4	150	-	-	-
		2750/24												
	53233	1500	1/2	6 1/4	3 1/2	2 1/4	1/2*	1 2 9/32	5/8	1 3/4	150	-	1	1
	53233L	1500	1/2	7 5/16	3 1/2	2	1/2	1 7/8	5/8	1 3/4	150	-	1	-
	53433L**	1500	1/2	7 5/16	3 3/8	3	1/2	1 7/8	5/8	1 3/4	150	-	1	-
	251-30485-1275	1250	1/2	6 3/16	3 1/2	2 1/8	9/16	1 2 9/32	5/8	1 3/4	150	-	-	-
	251-30485-1211	1750	-	6 3/8	3 3/8	3	1/2	2 3/16	-	-	175	-	-	2 (Fig. 2)
	251-30485-1212	1750	-	6 3/8	3 1/2	2 1/4	1/2	2 3/16	-	-	175	-	-	2 (Fig. 1)
	53239	2000	1/2	6 3/16	3 1/2	2 3/4	1/2	2 3/16	5/8	1 3/4	175	-	-	-
	53239L	169/0.110 178/0.104 2000	1/2	7 5/16	3 3/8	2 1/4	1/2	2 1 5/32	5/8	1 3/4	175	-	-	-
	53439L**	169/0.110 178/0.104 2000	1/2	7 5/16	3 3/8	3	1/2	2 3/16	5/8	1 3/4	175	-	-	11421 Die

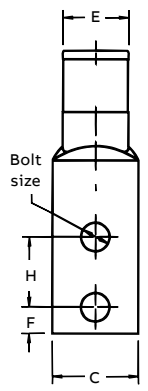

Figure 1

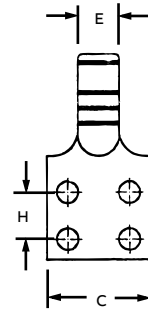
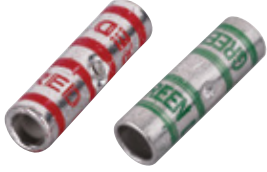

Figure 2

* Denotes tongue thickness of alternate construction (brazed wrought-copper tongue). ** Figure 2. All others figure 1. Tooling – see pages 104-127. Die selector chart – see pages 128-133.

Compression connectors for copper conductor

Two-way splice connectors – Standard barrel 600 V to 35 kV



Material – High conductivity wrought copper

Finish – Electro tin plate

Two-way connectors provide high pullout values, are easy to insulate and provide a low-resistance connection of high quality and low installed cost.

Two-way splice connectors – Standard barrel 600 V to 35 kV



Diagram	Cat. no.	Code (AWG or kcmil)	Wire size (AWG or kcmil)		Dimensions (in.)		Die code	Die color
			Flex class G, H, I, K, M [†]		A	E		
	54504	#8	37/24 = 14.9, #8 Weld		1.00	0.27	21	Red
	54505	#6	61/24 = 24.6, #6 Weld, 133/0.014		1.00	0.30	24	Blue
	54506	#4	91/24 = 36.7, 133/0.0177, 49/0.029		1.00	0.37	29	Gray
	54507	#2	125/24 = 50.4, #4 Weld		1.25	0.41	33	Brown
	54508	#1	150/24 = 60.5, 175/24 = 70.6, #2 Weld, 133/0.0223		1.50	0.47	37	Green
	54509	1/0	225/24 = 90.8, #1 Weld, 133/0.0254		1.63	0.52	42	Pink
	54510	2/0	275/24 = 111, 1/0 Weld, 427/0.0155, 133/0.0282		1.75	0.57	45	Black
	54511	3/0	325/24 = 131, 2/0 Weld, 133/0.0316, 259/0.0227, 427/0.0177		1.75	0.63	50	Orange
	53962		375/24 = 179, 133/0.0355, 259/0.0255, 427/0.0199		1.81	0.70	50	Orange
	54512	4/0	450/24 = 182, 3/0 Weld, 703/0.0154		1.88	0.70	54	Purple
	54513	250	550/24 = 222, 4/0 Weld, 133/0.0399, 259/0.0286, 637/0.0183		2.25	0.77	62	Yellow
	53964				2.13	0.79	62	Yellow
	54514	300	–		2.13	0.83	66	White
	54515	350	–		2.25	0.90	71	Red
	54516	400	–		2.75	0.93	76	Blue
	53968	500	1100/24 = 444, 500 Weld, 259/0.0417, 427/0.0325, 703/0.0253		3.00	1.13	87	Brown
	54518		–		2.75	1.11	87	Brown
	54520	600	–		3.00	1.18	94	Green
	54522-TB	700	–		3.25	1.23	99	Pink
	53969		1325/24 = 535, 427/0.0342		3.00	1.24	99	Pink
54523-TB	750	–		3.00	1.30	106	Black	
54528	1000	–		3.63	1.50	125	–	
54530	1250	–		4.13	1.67	140	–	

[†] Contact technical services for specific stranding listings

Tooling – see pages 104-127.

Die selector chart – see pages 128-133.

Compression connectors for copper conductor

Two-way splice connectors – Long barrel 600 V to 35 kV



Two-way splice connectors – Long barrel 600 V to 35 kV

Cat. no.	Code	Wire size (AWG or kcmil)	Dimensions (in.)		Die Code	Die color
		Flex class G, H, I, K, M†	A	E		
54804	#8	37/24 = 14.9	1.75	0.27	21	Red
54805	#6	61/24 = 24.6	1.75	0.31	24	Blue
54806	#4	91/24 = 36.7	1.75	0.39	29	Gray
54807	#2	125/24 = 50.4	1.88	0.43	33	Brown
54808	#1	150/24 = 60.5, 175/24 = 70.6	2.00	0.49	37	Green
54809*	1/0	225/24 = 90.8	2.00	0.54	42	Pink
54810*	2/0	275/24 = 111	2.13	0.59	45	Black
54811	3/0	325/24 = 131	2.25	0.65	50	Orange
54812*	4/0	450/24 = 182	2.75	0.72	54	Purple
54813*	250	550/24 = 222	3.38	0.79	62	Yellow

† Contact technical services for specific stranding listings
* UL listed for direct burial applications

Material – High conductivity wrought copper

Finish – Electro tin plate



Cat. no.	Code	Flex	Dimensions (in.)		Die	Die color
			A	E code		
54814	300	–	3.50	0.87	66	White
54815	350	650/24 = 262	3.75	0.95	71	Red
54816	400	775/24 = 313	3.75	0.98	76	Blue
54818*	500	925/24 = 373	4.75	1.11	87	Brown
54820	600	1100/24 = 444	4.25	1.21	94	Green
54823	750	1325/24 = 535	4.75	1.34	106	Black
58524	–	1600/24 = 646	5.00	1.39	106	–
58526	900	1925/24 = 777	5.50	1.51	115	Yellow
54828	1000	–	5.63	1.56	125	–
54833	1500	–	5.63	1.56	125	–
54839	2000	–	7.06	2.125	–	–

Diagram

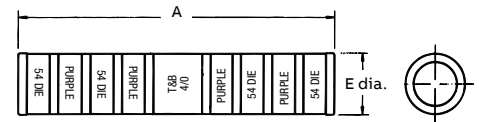

Tooling – see pages 104-127.
Die selector chart – see pages 128-133.

Compression connectors for copper conductor

Copper two-way splice connectors for 600 V to 35 kV applications



Copper two-way splice connectors for 600 V to 35 kV applications

Cat. no.	Cable size+ (AWG or kcmil)	Dimensions (in.)		Die set Cat. no.	Strip length (in.)	Installing tools	
		A	B			13100A, TBM151* & TBM14M	Color code
54006	#4	2.00	0.37	15CA29R	1½		Gray
54007	#2	2.13	0.41	15CA33R	1⅝		Brown
54008	#1	2.25	0.47	15CA37R	1⅝		Green
54009	1/0	2.38	0.52	15CA42R	1¾		Pink
54010	2/0	2.38	0.57	15CA45R	1¾		Black
54011	3/0	2.63	0.63	15CA49R	1⅞		Orange
54012	4/0	2.69	0.69	15CA54R	1⅞		Purple
54013	250	3.19	0.74	15CA60R	2⅛		Ruby
54015	350	4.13	0.89	15CA71R	2⅝		Red
54018	500	4.13	1.06	15CA87R	2⅝		Brown
54023	750	4.75	1.30	15CA106R	2⅞		Black

Diagram

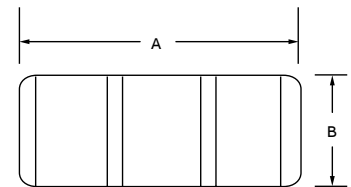

* Cat. No. 15500-TB die adapter required for TBM151.

+ Cable size: concentric and compact strandings.

Tooling – see pages 104-127.

Die selector chart – see pages 128-133.

Compression connectors for copper conductor

Cast-copper two-way splice connectors for 600 V to 35 kV applications – Heavy-duty



Material – Cast copper

Finish – Electro tin plate

Satisfies requirements of NEC® 250.64(C)(1) for connecting to the grounding electrode system.

NEC and National Electrical Code are registered trademarks of the National Fire Protection Association, Inc.



Cast-copper two-way splice connectors for 600 V to 35 kV applications – Heavy duty

Cat. no.	Cable size (AWG or kcmil)	Die code
53504	#8	29
53505	#6	29
53506	#4	29
53507	#2	45
53508	#1	45
53509	1/0	45
53510	2/0	66
53511	3/0	66
53512	4/0	66
53513	250	76
53515	350	99
53518	500	99
53523	750	112

Use hydraulic tools with hex dies.

Tooling – see pages 104-127.

Die selector chart – see pages 128-133.

Compression connectors for copper conductor

Copper reducing splices



Compact design for low-profile installation.

Thomas & Betts copper reducing splices are the most recent addition to the telecom line of copper compression lugs and connectors. They are designed for use in central office equipment installations in place of h-taps in applications where the main cable is stepped down. When space is at a premium and standard h-tap splicing options are too cumbersome, the Thomas & Betts reducing splices can be the right choice. These splices are available for a range of cables from 750 flex to 6 code.

- Requires less “real estate” in a central office
- Does not require a cover other than clear heat shrink
- One-person installation – each side crimped separately
- Utilizes standard lug crimping dies – more standard tooling options – lower tonnage tools can now install even the largest splice
- Hand tools can be used on splices for 500 code/350 flex and smaller
- Inspection holes verify cable is fully inserted into each barrel

Splices for the following cable combinations are available. Appropriate quantities of pre-cut lengths of UL® Listed clear-heat shrink are provided with each splice.

Copper reducing splices

Cat. no.	Main	Color code	Branch	Color
TBRS75F-75C50FHS	750 Flex	Yellow	750 Code/500 Flex	Black
TBRS75F-50C35FHS	750 Flex		500 Code/350 Flex	Brown
TBRS75F-25C4/0FHS	750 Flex		250 Code/4/0 Flex	Yellow
TBRS75C50F-75C50FHS	750 Code/500 Flex	Black	750 Code/500 Flex	Black
tbrs75c50f-50c35fhs	750 Code/500 Flex		500 Code/350 Flex	Brown
tbrs75c50f-25c4/0fhs	750 Code/500 Flex		250 Code/4/0 Flex	Yellow
TBRS75C50F-4/0CHS	750 Code/500 Flex		4/0 Code	Purple
TBRS4/0C-2CHS	4/0 Code	Purple	#2 Code	Brown
TBRS4/0C-6CHS	4/0 Code		#6 Code	Blue
TBRS2/0C1/0F-2CHS	2/0 Code/1/0 Flex	Black	#2 Code	Brown
TBRS2/0C1/0F-6CHS	2/0 Code/1/0 Flex		#6 Code	Blue
TBRS1/0C1F-2CHS	1/0 Code/1 Flex	Pink	#2 Code	Brown
TBRS1/0C1F-6CHS	1/0 Code/1 Flex		#6 Code	Blue
TBRS2C-6CHS	#2 Code	Brown	#6 Code	Blue

Tooling – see pages 104-127.

Die selector chart – see pages 128-133.

Compression connectors for copper conductor

Cast-copper reducing splices



01 Simple installation with Blackburn® compression tools (see pages 104-127) and dies (see pages 128-133)

Thomas & Betts takes the splicing of different-sized conductors to a new level of economy and efficiency with cast-copper reducing splices. In addition to a lower cost, the key benefit to these splices is in their constant outer diameter. Unlike screw-machined, externally contoured splices, cast-copper reducing splices require no change of tool or die between crimping each end. Just slide each wire easily into the chamfered barrel, and use the same color-keyed tool and die to crimp both ends. The consistent O.D. also makes these splices faster and easier to insulate with clear heat-shrink wrap than a contoured strength for heavy-duty applications, and tin-plated copper material provides high conductivity and superior corrosion resistance.

- Ideal for telecom (inside office/outside plant), commercial, industrial MRO and any other 600 V–35 kV applications requiring splicing of different-sized conductors
- Tin-plated, sand-cast copper construction provides superior tensile strength, high conductivity, and excellent corrosion resistance
- Easier to install and insulate than screw-machined, contour-designed reducing splices
- Constant O.D. saves time on installation by eliminating the need for crimp tool/die change
- Fast and simple to insulate with clear or colored heat-shrink wrap
- Chamfered barrel facilitates easy wire insertion
- Compact, low-profile design takes up minimal space in cable tray or wire run

Cast-copper reducing splices



Cat. no.	Cable size (AWG or kcmil)		Dimensions (in)		Die code	Die color
	Cond. 1	Cond. 2	A	E		
251-30485-19	4/0 Str.	#2 Str.	2¼	1¾	66	White
251-30485-91	500 Str.	300 Str.	3¾	1¾	99	Pink
251-30485-229	2/0 Str.	250 Str.	2¾	1¾	76	Blue
251-30485-247	#2 Str.	#8 Str.	1¾	1½	45	Black
251-30485-294	#4 Str.	2/0 Str.	2¼	2½	66	White
251-30485-295	4/0 Str.	#4 Str.	2¼	1¾	66	White
251-30485-331	4/0 Str.	350 Str.	3¾	1½	99	Pink
251-30485-445	4/0 Str.	2/0 Str.	2¼	1¾	66	White
251-30485-495	1/0 Str.	#2 Str.	1¾	1½	45	Black
251-30485-610	#6 Str.	#8 Str.	1½	¾	29	Gray
251-30485-611	#4 Str.	#8 Str.	1½	¾	29	Gray
251-30485-612	#4 Str.	#6 Str.	1½	¾	29	Gray
251-30485-613	#2 Str.	#6 Str.	1¾	1½	45	Black
251-30485-640	4/0 Str.	1/0 Str.	2¼	1¾	66	White
251-30485-653	#2 Str.	250 Str.	2¾	1¾	76	Blue
251-30485-739	1/0 Str.	250 Str.	2¾	1¾	76	Blue
251-30485-882	400 Str.	350 Str.	3¾	1½	99	Pink
251-30485-950	1/0 Str.	#6 Str.	1¾	1½	45	Black
251-30485-951	#6 Str.	2/0 Str.	2¼	2½	66	White
251-30485-1027	1/0 Str.	#4 Str.	1¾	1½	45	Black
251-30485-1029	1/0 Str.	#12 Str.	1¾	¾	45	Black
251-30485-1030	10 Str.	#4 Str.	1½	¾	29	Gray
251-30485-1031	12 Str.	#4 Str.	1½	¾	29	Gray
251-30485-1032	#6 Str.	#10 Str.	1½	¾	29	Gray
251-30485-1033	#12 Str.	#6 Str.	1½	¾	29	Gray
251-30485-1034	#14 Str.	#8 Str.	1½	¾	29	Gray

*Cast solid – field modifiable special.

Cat. no.	Cable size (AWG or kcmil)		Dimensions (in)		Die code	Die color
	Cond. 1	Cond. 2	A	E		
251-30485-1035	#1 Str.	1/0 Str.	1¾	1½	45	Black
251-30485-1044	#10 Str.	#8 Str.	1½	¾	29	Gray
251-30485-1045	#12 Str.	#8 Str.	1½	¾	29	Gray
251-30485-1085	#10 Str.	1/0 Str.	1¾	1½	45	Black
251-30485-1086	#10 Str.	2/0 Str.	2¼	2½	66	White
251-30485-1087	#4 Str.	250 Str.	2¾	1½	76	Blue
251-30485-1088	400 Str.	250 Str.	3¾	1½	99	Pink
251-30485-1089	#14 Str.	#8 Sol.	1½	¾	29	Gray
251-30485-1090	#12 Str.	#8 Sol.	1½	¾	29	Gray
251-30485-1091	#10 Str.	#8 Sol.	1½	¾	29	Gray
251-30485-1092	#12 Str.	#6 Sol.	1½	¾	29	Gray
251-30485-1093	#8 Str.	#6 Sol.	1½	¾	29	Gray
251-30485-1094	#4 Str.	#6 Sol.	1½	¾	29	Gray
251-30485-1095	#2 Str.	#6 Sol.	1¾	1½	45	Black
251-30485-1096	#12 Str.	#4 Sol.	1½	¾	29	Gray
251-30485-1097	#10 Str.	#4 Sol.	1½	¾	29	Gray
251-30485-1098	#8 Str.	#4 Sol.	1½	¾	29	Gray
251-30485-1099	#6 Str.	#4 Sol.	1½	¾	29	Gray
251-30485-1100	1/0 Str.	#4 Sol.	1¾	1½	45	Black
251-30485-1130	Cast Solid* #12–#4 Str.		1½	¾	29	Black
251-30485-1245	1/0 Flex	#4 Flex	2¼	1¾	66	White
251-30485-1246	#4 Flex	#8 Flex	1¾	¾	45	Black

C-Tap connectors for copper conductor

C-Taps for 600 V applications

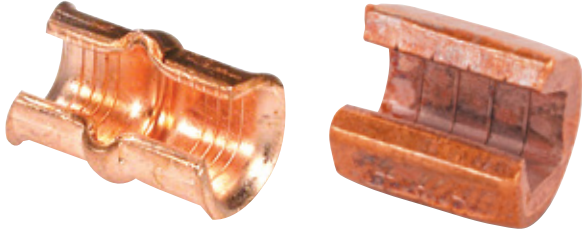

Positive, all-around compression with low resistance and high pull-out values.

Material – High-conductivity wrought copper

Finish – Plain

Ideal for pigtailing, two-way splicing or tapping to an unbroken continuous main

- Heavy reinforcing ribs help locate compression dies and strengthen compressed joint



C-Taps for 600 V applications

Cat. no.	Fig. No.	Dimensions (in)			Color key
		L	H	E	
54705	1	5/16	5/16	7/64	Red
54710	1	9/16	7/16	9/64	Blue
54715	1	9/16	5/8	11/64	Gray
54720	2	1 5/32	1 1/16	7/32	Brown
54725	2	1 5/32	1 3/16	1/4	Green
54730	2	1 5/32	2 7/32	9/32	Pink
54735	3	1 11/16	7/8	2 1/64	Black
54740	3	1 11/16	3 1/32	2 3/64	Orange
54745	3	1 11/16	1 3/16	1 3/32	Purple
54750	3	1 11/16	1 3/16	1 5/32	Yellow

Diagrams

Figure 1

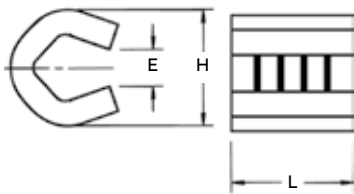

Figure 2 — “E” represents gap in side

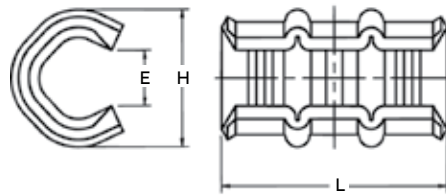
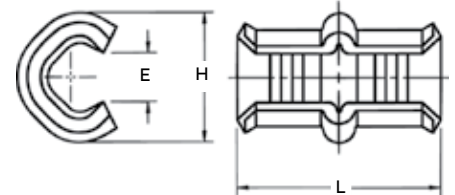

Figure 3



UL* approved for direct burial.

For covers, see page 58.

Taps can be supplied tin-plated. Add suffix “TP” to any catalog number (i.e., 54725TP).

Typical cable combinations

Main (AWG)	Branch (AWG)							
	#12 Sol. or str.	#10 Sol. or str.	#8 Sol. or str.	#6 Sol. or str.	#4 Str.	#2 Str.	#1 Str.	1/0 Str.
#10 Sol. or str.	54705	54710	54715	54715	54720	54730	54735	54740
#8 Sol. or str.	54710	54715	54715	54720	54720	54730	54735	54740
#6 Sol. or str.	54715	54715	54720	54720	54725	54730	54735	54740
#4 Str.	54720	54720	54720	54725	54730	54735	54740	54740
#2 Str.	54730	54730	54730	54730	54735	54740	54745	54745
#1 Str.	54735	54735	54735	54735	54740	54745	54745	54750
1/0 Str.	54740	54740	54740	54740	51740	54745	54750	54750
2/0 Str.	54745	54745	54745	54745	54745	54750	54750	–
3/0 Str.	54750	54750	54750	54750	54750	54750	–	–

Tooling – see pages 104-127.

Die selector chart – see pages 128-133.

C-Tap connectors for copper conductor

C-Taps – large size for 600 V applications



Easy to work with in tight spaces.

Material – High-conductivity wrought copper

Finish – Plain

- More economical than other taps and split bolts in terms of purchase, inventory, installation time, insulation and maintenance
- Color-coded for easy matching with proper die
- Barely larger than conductor insulation once installed



C-Taps – large size for 600 V applications

Diagram	Cat. no.	Wire size (AWG or kcmil)		Dimensions (in.)			Installing die		Die code	No. of crimps	Color key
		Main	Branch	C	D	E	Tool	Cat. no.			
	54755	#1	#1	1 ¹⁵ / ₁₆	3/4	1 ⁷ / ₃₂	TBM14M	15512	76	1	Blue
		1/0	1/0-#2				TBM15I	15512*	76		
		2/0	2/0-#4				TBM12	TBM12D-4	76		
		3/0	1/0-#6				13100A	15512	76		
		4/0	#1-#8								
	54760	2/0	2/0-#1	1 ⁷ / ₁₆	3/4	1 ⁹ / ₃₂	TBM14M	15506	87H	2	Brown
		3/0	3/0-#3				TBM15I	15506*	87H		
		4/0	4/0-#4				TBM12	TBM12D-3	87H		
		250	#1-#8				13100A	15506	87H		
	54765	2/0	2/0-#1	1 ¹¹ / ₁₆	1	4 ¹ / ₆₄	TBM14M	15505	99H	2	Pink
		3/0	3/0-#2				TBM15I	15505*	99H		
		4/0	4/0-#4				TBM12	TBM12D-2	99H		
		250	3/0-#6				13100A	15505	99H		
		300	2/0-#8								
	54770	4/0	4/0-2/0	1 ¹¹ / ₁₆	1	1 ¹ / ₁₆	TBM14M	15515	106H	2	Black
		250	250-#1				TBM15I	15515*	106H		
		300	4/0-#4				TBM12	TBM12D-2	106H		
		350	3/0-#6				13100A	15515	106H		
	54775**	250	250	1 ⁷ / ₈	1 ³ / ₄	1 ³ / ₁₆				2	Yellow
		300	300-3/0				TBM14M	15504	115H		
		350	350-1/0				TBM15I	15504*	115H		
		400	300-#2				TBM12	TBM12D-1	115H		
		450	250-#4				13100A	15504	115H		
		500	250-#6								
	54780	350	350-4/0	2 ³ / ₁₆	1 ³ / ₄	5 ³ / ₆₄	TBM15I	15603	125H	2	-
		400	400-2/0								
		450	450-#1								
		500	500-#2								
	54785	750	4/0-#6	2 ¹ / ₈	2	1	TBM15I	15603	125H	3	
	54790	750	750-4/0	2 ¹¹ / ₁₆	2	1 ⁵ / ₁₆	TBM15I	15603	125H	3	

UL* approved for direct burial.

For covers, see page 58.

Taps can be supplied tin-plated. Add suffix "TP" to any catalog number (i.e., 54725TP).

* Cat. no. 15500-TB adapter required if using TBM15I and 155XX series dies.

** #6 AWG branch must be doubled.

Tooling – see pages 104-127.

Die selector chart – see pages 128-133.

Copper H-tap connectors for copper conductor

Copper H-taps – 600 V applications



Copper H-taps – 600 V applications

Cat. no.	Fig. no.	Color code	Conductor size code (flex cable) (AWG or kcmil)				Hydraulic head	Installing die	# of crimps	Color code	Die code	Strip length (in.)	Insulating covers
			Main	Branch 1	Branch 2	Branch 3							
CHT750350-1F	1	White	(750–500) (750) Flex only	(750–500) (350) Flex only	–	–	TBM15I	15620CHF	1	White	F	1½	HTC1000
CHT750350-2	2	Yellow	750–500 (550–500)	750–500 (550–350)	–	–	TBM15I	15620CH	1	Yellow	Z	1¾	HTC500
CHT75010-3	9	Yellow	750–350 (550–500)	4/0–1/0 (250–1/0)	1 Str. 2–6 (1–8)	2–14 (2–14)	TBM15I	15620CH	1	Yellow	Z	1½	
CHT50040-4	2	Brown	500–250 (350–4/0)	500–4/0 (350–4/0)	–	–	TBM15I	15612CH	2	Brown	N	1½	
50010-5	3	Brown	500–4/0 (350–4/0)	250–1/0 (4/0–1/0)	1 Str. 2–6 (1–8)	8–14 (8–14)	TBM15I	15612CH	2	Brown	N	1½	
CHTCHT2502-6	2	Purple	250–2 (4/0–2)	250–2 (4/0–2)	–	–	TBM15I• TBM14M	15CA80RCH	1	Purple	80R	1⅜	HTC40
CHT25014-7	4	Purple	250–2 (4/0–2)	2–6 Str./Sol. (2–8)	8–14 (8–14)	–	TBM15I• TBM14M	15CA80RCH	1	Purple	80R	1½	
CHT250214-8	5	Purple	250–2 (4/0–2)	8–14 (8–14)	8–14 (8–14)	–	TBM15I• TBM14M	15CA80RCH	1	Purple	80R	1½	
CHT214-9	6	Brown	2–6 Str./Sol. (2–8)	2–6 Str./Sol. (2–8)	8–14 (8–14)	8–14 (8–14)	TBM15I• TBM14M 13100A	15CA71RCH	3	Brown	71R	7/8	
CHT814-10	7	Green	8–14 (8–14)	8–14 (8–14)	–	–	TBM15I• TBM14M 13100A	15CA37RCH	1	Green	37R	½	HTC2S
CHT75040-11	8	Yellow	750 Str. (750–500)	350–4/0 Str. Cu. & Flex	–	–	TBM15I	15620CH	1	Yellow	Z	1½	HTC500

• Requires adapter Cat. no. 15500-TB when used with hydraulic head TBM15I.

Material: copper per ASTM designation B-124-55 alloy 12

Available packaged with HTC series covers. Add "WC" to standard catalog number.

Tooling – see pages 104-127.

Die selector chart – see pages 128-133.

Copper H-tap connectors for copper conductor

Copper H-taps – 600 V applications (continued)

Material – High conductivity extruded copper
Finish – Electro tin plate



Copper H-taps – 600 V applications

Cat. no.	Fig. no.	Dimensions (in.)								Strip length (in.)	Insulating covers
		H	W	L	A	D	D1	D2	D3		
CHT750350-1F	1	3.46	1.66	1.10	1.73	1.23	-	-	-	1 1/8	HTC1000
CHT750350-2	2	3.24	1.50	1.25	1.62	1.02	-	-	-	1 3/8	HTC500
CHT75010-3	9	3.13	1.50	1.00	1.54	1.00	0.40	0.35	0.41	1 1/8	
CHT75040-11	8	3.19	(1) 1.65	1.00	(1) 1.61	(1) 1.24	-	-	-	1 1/8	
	-	-	-	(2) 1.05	-	(2) 1.29	(2) 0.80	-	-	-	
CHT50040-4	2	2.64	1.18	1.00	1.32	0.80	-	-	-	1 1/8	
CHT50010-5	3	2.28	1.30	1.00	1.20	0.80	0.67	0.19	0.43	1 1/8	
CHT2502-6	2	1.99	.90	.66	1.00	0.62	-	-	-	1 3/16	HTC40
CHT25014-7	4	1.63	0.90	0.90	0.96	0.52	0.35	0.19	-	1 1/8	
CHT250214-8	5	1.63	0.90	0.90	0.96	0.62	0.19	0.19	-	1 1/8	
CHT214-9	6	1.35	0.60	0.75	0.50	0.33	0.19	0.19	-	7/8	
CHT814-10	7	0.62	0.60	0.37	0.25	0.16	-	-	-	1/2	HTC2S

Diagrams

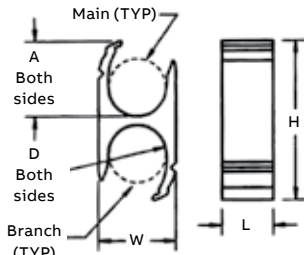

Figure 1

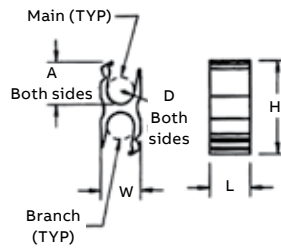

Figure 2

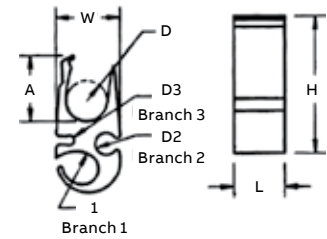

Figure 3

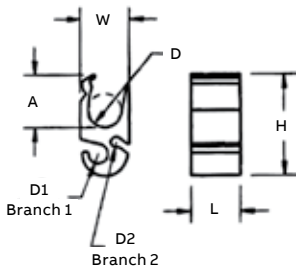

Figure 4

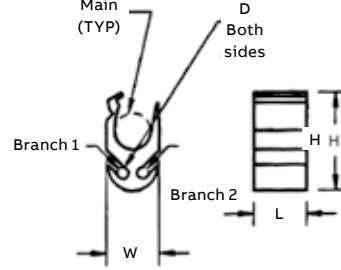

Figure 5

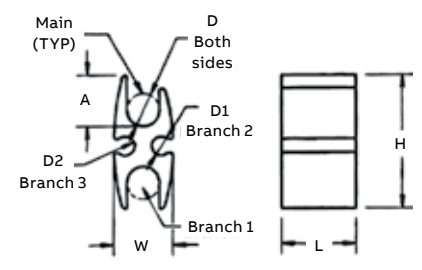

Figure 6

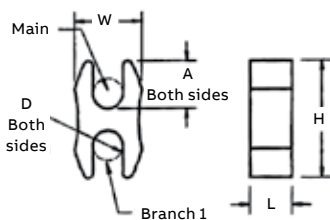

Figure 7

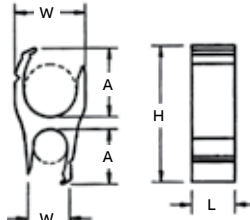

Figure 8

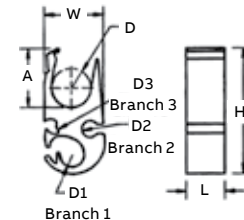

Figure 9

Aluminum H-tap connectors

Compression taps for 600 V, 90 °C applications



Exclusive FILLERLOK tab design.

Material – High-conductivity wrought aluminum

- H-type compression taps
- For aluminum-to-aluminum, aluminum-to-copper and copper-to-copper stranded-conductor applications
- Concentric and compact code strandings

Compression taps for 600 V, 90 °C applications



Cat. no.	Combinations (AWG or kcmil)			Length (in.)	Color key	Die code cat. no.			
	Main	Branch	Side tap			TBM6 TBM6S TBM6ORS	Hydraulic TBM14M 13100A	TBM12 12-ton head	TBM151 15-ton head
63105 [†]	#2-6	#8-14	-	¾	Orange	13474 upper 13477 lower	15530	TBM12D-4	15530*
63110	#4-6	#4-6	-	1½	Green	13470	15501A	TBM12D-H	15001A*
63118	2/0-2	#8-14	-	¾	Green	13470	15501A	TBM12D-H	15501A*
63125	2/0-2	1/0-6	-	1½	Green	13470	15501A	TBM12D-H	15501A*
63140	4/0-2/0	#2-10	-	1½	Blue	13471	15502	TBM12D-H	15502*
63148•	4/0-2/0	3/0-1	#8-14	3	Blue	-	15502	TBM12D-H	15502
63160	500-4/0	4/0-#2	#2-6	2¾	Red	-	-	-	15612
63169	750-4/0	750-4/0	-	3	Black	-	-	-	15620
63170	1000-500	1000-1/0	-	6	Black	-	-	-	15620
63180	750-350	350-1/0	#1-6	3	Black	-	-	-	15620

* Use with adapter cat. no. 15500-TB

[†] 63105 Also installed by TBM5/TBM5S with 13455 die or TBM8/TBM8S with 13462 die.

• 63148 – #1 Cu or Al wire bent double (hairpin)

For smart tool installation

63110, 63118, 63125: Use TBM8-750HG

63140, 63148: Use TBM8-750BH

Tooling – see pages 104-127.

Die selector chart – see pages 128-133.

Interlocking insulating covers for compression taps

Soft shell H-Tap/C-Tap covers

- 01 Smaller size requires less space in enclosure
High-impact polypropylene for rugged, dependable use
- 02 Clear, polycarbonate (UL94V-0) version available
- 03 Easy latch mechanism

Better covers for taps.

Thomas & Betts offers an improved design for one-piece covers of H-Tap and C-Tap connectors. The new design is more size-efficient and includes an easy latch mechanism. The new covers also contain flash barriers to help protect against electrical flash overs. The covers are molded from high-impact polypropylene (UL94V-1) and are UL® listed, CSA certified to 600 V applications at 105 °C.

Blackburn® soft shell covers include these features:

- **Size-efficient design**
Won't take up as much room in the enclosure or vault, easier to store and carry to the job site
- **Easy latch mechanism**
Quick but sturdy cover latch for optimum insulation

- **Flash barriers**

Provides protection from electrical flashovers

- **105 °C rating**

Offers maximum performance and higher than many competitors' temperature ratings

- **High-impact polypropylene**

Constructed from rugged materials for long-lasting protection

Also available in clear, impact-resistant and flame-retardant polycarbonate (UL94V-0). The clear version includes an internal pocket for a visible identification label without opening the cover. Contact Customer Service for shipping and availability.



01



02



03

Cat. no.	For H-taps	For C-taps	Dimensions (in.)			Pkg. qty.
			A	B	C	
HTCV1	CHT814-10	54705, 54710, 54715	1¾	7/8	9/16	5
HTCV2	CHT214-9, CHT250214-8, CHT25014-7, CHT2502-6	54770, 54775, 54780	3¾	1½	1	5
HTCV3	CHT50010-5, CHT50040-4	54740, 54745, 54750, 54755, 54760, 54765	3 ²⁷ / ₃₂	1½	1 ⁵ / ₁₆	5
HTCV4	CHT75010-3, CHT750350-2, CHT750350-1F, CHT75040-11	—	5½	2	1 ¹¹ / ₁₆	5
HTCV2CLRFR	CHT214-9, CHT250214-8, CHT25014-7, CHT2502-6	—	3¾	1¾	1	5

Diagram

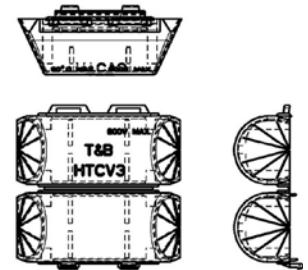

Interlocking insulating covers for compression taps

H-Tap insulating covers (soft cover)



Quick and easy insulation for H-type compression taps.

- Eliminates taping
- Provided with three positive locking latches and overlapping fringe for maximum cable insulation

Specifications

- Rating: 90 °C, 600 V. Made of flame-retardant, high-impact polypropylene.
- Material: Polypropylene
- Color: Black
- Voltage Rating: 600 V max.
- Temperature: 90 °C

H-Tap insulating covers (soft cover)



Cat. no.	Wire range (AWG or kcmil)		Al H-taps	Use to insulate	Dimensions (in.)			"A" dim.	"B" dim.
	Max.	Min.			A	B	C		
HT20C	2/0	#6	63110/63115 63125/63120	-	4½	1¼	1½	-	-
HT40C	4/0	#6	63140 63148	-	5 ³⁹ / ₆₄	1 ¹³ / ₃₂	1 ¹ / ₁₆	-	-
HT600C	500	#2	63160	63169	6 ¹³ / ₁₆	2½	1 ³⁹ / ₆₄	-	-
HT1000C	1000 to 500	250 to 1/0	63180	-	-	-	-	7.250 (184.15 mm)	2.330 +.060
HT1000C-L	1000 to 500	250 to 250	63170	-	-	-	-	10.374 (263.40 mm)	2.330 +.060

Diagram

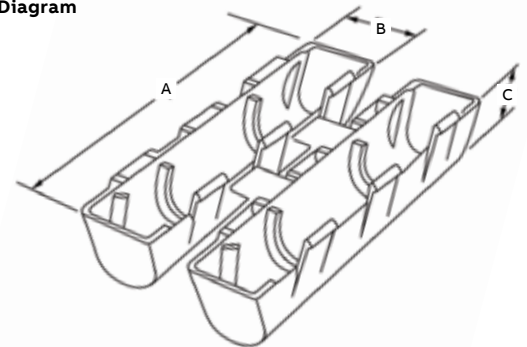

(C) Height – typical both halves

Interlocking insulating covers for compression taps

H-Tap insulating covers (hard covers)

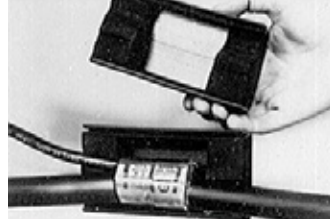

01

01 These insulating covers provide hard-shell insulated protection for "H" type compression taps and splices, and because there is no taping required, you get uniform quality and appearance each time. The exclusive locking design provides the range-taking capability. Only five h-tap insulating catalog cover numbers accommodate the range of #6 AWG–1000 kcmil in the main, and #12 AWG–500 kcmil in the branch.

For H-Tap applications

Cat. no.	Al H-tap	Cu H-tap
HTC2	63105	–
HTC2S	–	CHT814-10
HTC40	63110	CHT214-9
–	63118	CHT250214-8
–	63125	CHT2514-7
–	63140	CHT2502-6
HTC500	63148	CHT50010-5/CHT50040-4
–	63160	CHT75010-3/CHT750350-2
HTC1000L	63170	–
HTC1000	63180/63169	CHT750350-1F

- For use in splice boxes, indoors or in tray indoors
- Easy to use – simply place H-tap in cover and snap cover closed
- Consult factory for available flame-retardant version
- Hard shell outer covers guard against impact, inner seal keeps out dust
- Installs quickly and easily without special tools — simply snap together
- Eliminates time-consuming taping
- Provides high-quality, neat, uniform installations
- Range-taking design reduces inventory

For C-Tap applications

Cat. no.	C-tap	Color code
HTC40	54720	Brown
	54725	Green
	54730	Pink
	54755	Blue
	54760	Brown
HTC40L2	54735	Black
	54740	Orange
	54745	Purple
	54750	Yellow
	HTC500	54765
54770		Black
54775		Yellow
54780		White
–	54785	–
HTC1000	54790	–



Cat. no.	Dimensions (in.)		
	A (length)	B (height)	C (width)
HTC2S	2	1 ¹ / ₈	1 ⁷ / ₁₆
HTC2	3 ¹ / ₂	1 ¹ / ₈	1 ⁷ / ₁₆
HTC40	4 ¹ / ₄	1 ⁹ / ₁₆	2
HTC40L2	5 ³ / ₄	1 ⁹ / ₁₆	2
HTC500	6	1 ³ / ₄	2 ³ / ₄
HTC1000	7	2 ³ / ₈	3 ³ / ₈
HTC1000L	10	2 ³ / ₈	3 ³ / ₈

Interlocking insulating covers for "H" type compression taps. For use in splice boxes, indoors or in tray indoors. Place the H-tap in the cover. Snap the cover closed. Consult factory for flame-retardant version. Technical data: HTC2 and HTC2S use insulation wrap instead of end cushions for inner seal. Connector cat. nos. 54755 Through 54790 and 63148 through 63180 require hydraulic crimping tools. Refer to instruction sheets. Outer hard shell covers

– High-impact black thermoplastic (noryl), flammability class UL[®] 94 V-1 inner seal
– Black neoprene sponge soft closed cell, oxygen index 28% ul 94 hbf

Temperature rating – 90 °C maximum

Voltage rating – 600 V maximum

Uses insulation wrap instead of end cushions for inner seal.

Note: insulation covers are not reusable.

Dimensions

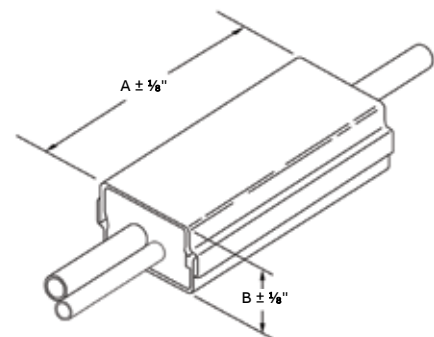

Wire joints for copper conductor

Compression wire joints for copper conductor



All-around compression ensures high conductivity, low resistance and high pull-out values exceeding UL® requirements.

- Ideal for pigtail, tapping multiple conductors or two-way splicing
- Form a permanent installation in minimal space
- Easily insulated
- Offer lowest installed cost
- Made of high-conductivity copper and electro-tin-plated
- Colored-coded to dies for positive matching and compression



Compression wire joints for copper conductor

Cat. no.	Circular mil area		Connector range				Color code	Installing tools				
	Min.	Max.	Cable combination (AWG)		Dimensions (in.)			TBM25S/21E	TBM8/8S	TBM5/5S	TBM6 & TBM6S	
			Min.	Max.	A	E		Die Cat. no.	Die Cat. no.	Die Cat. no.	Upper	Lower
54610	19,590	27,290	(3) #12 sol. or str.	(2) #10 w/(1) #12 sol. or str.	0.407	0.370	Blue	Included	-	-	13475	13477
54615	31,140	43,400	(3) #10 sol. or str.	(4) #10 sol. or str.	0.407	0.430	Gray	Included	13461	13454	13472	13476
54620	49,530	65,560	(3) #8 sol. or str.	(1) #4 w/(2) #10 sol. or str.	0.417	0.475	Brown	Included	-	-	13474	-
54625-TB	66,040	87,130	(4) #8 sol. or str.	(1) #2 str w/(2) #12 sol. or str.	0.479	0.545	Green	-	-	-	-	-
54630	83,480	99,990	(2) #4 sol. or str.	(2) #4 w/(1) #10 sol. or str.	0.479	0.585	Pink	-	13462	13455	13475	13477
54635	99,060	124,220	(6) #8 str.	(2) #4 w/(2) #8 sol. or str.	0.762	0.620	Black	-	-	-	13474	-
54640	125,220	166,120	(3) #4 sol. or str.	(3) #4 w/(2) #10 sol. or str.	0.762	0.695	Orange	-	-	-	-	-
54645-TB	166,960	193,630	(4) #4 sol. or str.	(2) #1 w/(2) #10 sol. or str.	0.824	0.770	Purple	-	13463	13456	13475	-
54650	189,190	244,020	(3) #2 str.	(2) #1/0 w/(2) #8 str.	0.887	0.830	Yellow	-	-	-	13473	13476

Diagram

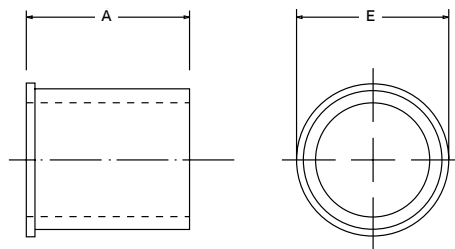

Hand tools only.
 UL Listed E9809 – code stranded.
 Tooling – see pages 104-127.
 Die selector chart – see pages 128-133.

Cast copper bus taps for copper conductor

Heavy-duty bus bar taps – Straight barrel for 600 V to 35 kV applications



Clamps onto bus bar – No drilling required.

- For bus bars up to ¼" thick, 3–6" wide and code copper cable
- Takes up less than 1¼" of bus bar space
- Convex shape of connector tongue exerts great contact pressure on bus bar
- Installs with hydraulic tools and hex crimp dies

Material – High-conductivity cast copper alloy

Finish – Electro tin plate

Contact material – Beryllium copper

Finish – Silver

Heavy-duty bus bar taps – Straight barrel for 600 V to 35 kV applications

Cat. no.	Wire flex (AWG or kcmil)		Fig. no.	Busbar width (in.)	Dimensions (in.)			Die Code
	Code	Flex			A	B	C	
251-31446-1	1/0	225/24	1	3	6½	2⅝	3½	66H
251-31446-7			1	4	7½	2⅝	4½	66H
251-31446-13			2	5 or 6	9½	2⅝	6⅜	66H
251-31446-8	2/0	1/0	1	4	7½	2⅝	4½	66H
251-31446-14		275/24	2	5 or 6	9½	2⅝	6⅜	66H
251-31446-23	4/0	450/24	1	3	6½	2⅝	3½	66H
251-31446-22			1	4	7½	2⅝	4½	66H
251-31446-19			2	6	9½	2⅝	6⅜	66H
251-31446-29	250	4/0	1	3	5½	2⅝	3⅜	66H
251-31446-30		550/24	1	4	7½	2⅝	4½	66H
251-31446-31			1	5 or 6	9½	2⅝	6⅞	66H
251-31446-3	350	–	1	3	6⅝	2⅝	3½	99H
251-31446-9			1	4	7⅝	2⅝	4½	99H
251-31446-15			2	5 or 6	9⅝	2⅝	6⅜	99H
251-31446-4	500	350	1	3	6⅝	2⅝	3½	99H
251-31446-10		925/24	1	4	7⅝	2⅝	4½	99H
251-31446-16			2	5 or 6	9⅝	2⅝	6⅜	99H
251-31446-17	600	–	2	5 or 6	9¾	2¾	6⅜	112H
251-31446-21	700	–	1	6	9¾	2¾	6⅞	112H
251-31446-6	750	500	1	3	6¾	2¾	3½	112H
251-31446-12		1325/24	2	4	7¾	¾	4½	112H
251-31446-18			2	5 or 6	9¾	2¾	6⅜	112H
251-31446-36	–	750 1925/24	2	5 or 6	9¾	2¾	6⅞	112H

Diagrams

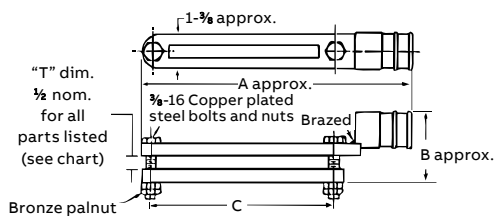

Figure 1

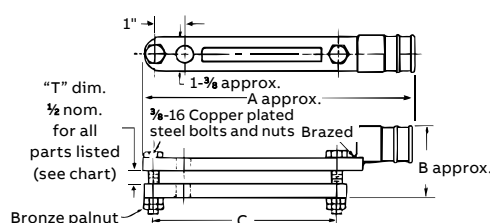
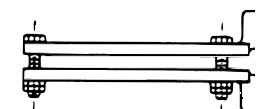

Figure 2



Double cable—Use AD suffix

Styles shown have cable tap on one portion of clamp assembly. Clamp assemblies with cable taps on both portions (top & bottom identical) are also available. These assemblies are identified by adding suffix "AD" to part numbers shown. Example: 251-31446-1AD. Only use hydraulic tools with hex crimp dies. Tooling – see pages 104-127. Die selector chart – see pages 128-133.

Motor pigtail connectors

Motor lead disconnects



Quick, reliable change-out of electric motors with no bolting, taping or loose connections.

- Complete line of motor lead disconnects for 600 V and 5 kV applications, covering wire range from #16 AWG through 500 kcmil
- Fast, snap-together assembly offers maximum labor savings
- No need for nuts, bolts and washers or insulating tape – simply slide on reusable boot
- Total assembly fits into tight motor housings
- Quick disconnect – no knife cutting of melted tape, eliminating the risk of accidental cutting of wire insulation, resulting motor downtime and installer exposure

- Meet or exceed electrical and mechanical performance of bolted connections
- Constructed of high-conductivity copper with tin plating
- Female disconnects equipped with beryllium copper interface band for dependable connections

Motor pigtail connector – One line to one load (2 wire)

Cat. no.		Wire size (AWG or kcmil)	Body size	Color code	Boot insulation	Dimensions (in.)						Strip length (in.)
Female disconnect	Male disconnect					A	B	C	D	E	F	
MD1614F-0	MD1614M-0	#16-#14	0	Blue	MDBOOT-0	0.25	0.25	0.63	0.52	0.25	0.125	3/8
MD1614F-1	MD1614M-1	#16-#14	1		MDBOOT-1	0.38	0.38	0.78	0.75	0.38	0.250	3/8
MD1210F-1	MD1210M-1	#12-#10	1	Yellow	MDBOOT-1	0.38	0.38	0.78	0.75	0.38	0.250	3/8
MD1210F-2	MD1210M-2	#12-#10	2		MDBOOT-2	0.50	0.50	0.90	1.00	0.50	0.370	3/8
MD8F-1	MD8M-1	#8	1	Red	MDBOOT-1	0.38	0.38	0.82	0.75	0.38	0.250	7/16
MD8F-2	MD8M-2	#8	2		MDBOOT-2	0.50	0.50	0.95	1.00	0.50	0.370	7/16
MD6F-1	MD6M-1	#6	1	Blue	MDBOOT-1	0.38	0.38	0.88	0.75	0.38	0.250	1/2
MD6F-2	MD6M-2	#6	2		MDBOOT-2	0.50	0.50	1.02	1.00	0.50	0.370	1/2
MD4F-2	MD4M-2	#4	2	Gray	MDBOOT-2	0.50	0.50	1.06	1.00	0.50	0.370	1/2
MD2F-2	MD2M-2	#2	2	Brown	MDBOOT-2	0.50	0.50	1.09	1.00	0.50	0.370	17/32
MD2F-3	MD2M-3	#2	3		MDBOOT-3	0.88	0.88	1.46	1.75	0.88	0.500	17/32
MD1F-2	MD1M-2	#1	2	Green	MDBOOT-2	0.50	0.50	1.23	1.00	0.50	0.370	9/16
MD1F-3	MD1M-3	#1	3		MDBOOT-3	0.88	0.88	1.56	1.75	0.88	0.500	9/16
MD10F-3	MD10M-3	1/0	3	Pink	MDBOOT-3	0.88	0.88	1.56	1.75	0.88	0.500	9/16
MD20F-3	MD20M-3	2/0	3	Black	MDBOOT-3	0.88	0.88	1.59	1.75	0.88	0.500	9/8
MD30F-3	MD30M-3	3/0	3	Orange	MDBOOT-3	0.88	0.88	1.71	1.75	0.88	0.500	1 1/16
MD40F-3	MD40M-3	4/0	3	Purple	MDBOOT-3	0.88	0.88	1.81	1.75	0.88	0.500	3/4
MD40F-4	MD40M-4	4/0	4		MDBOOT-4	1.25	1.25	2.89	2.69	1.25	0.813	-
MD250F-4	MD250M-4	250	4	Yellow	MDBOOT-4	1.25	1.25	2.89	2.69	1.25	0.813	-
MD350F-4	MD350M-4	350	4	Red	MDBOOT-4	1.25	1.25	2.89	2.69	1.25	0.813	-
MD500F-4	MD500M-4	500	4	Brown	MDBOOT-4	1.25	1.25	2.89	2.69	1.25	0.813	-

Diagrams

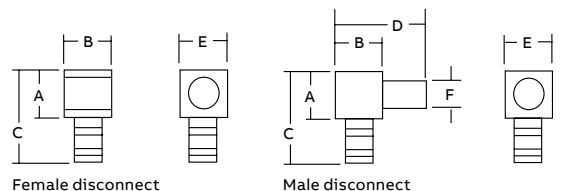

Tooling – see pages 104-127.
Die selector chart – see pages 128-133.

Motor pigtail connectors

Motor pigtail connector – One line to one load (2 wire) (continued)

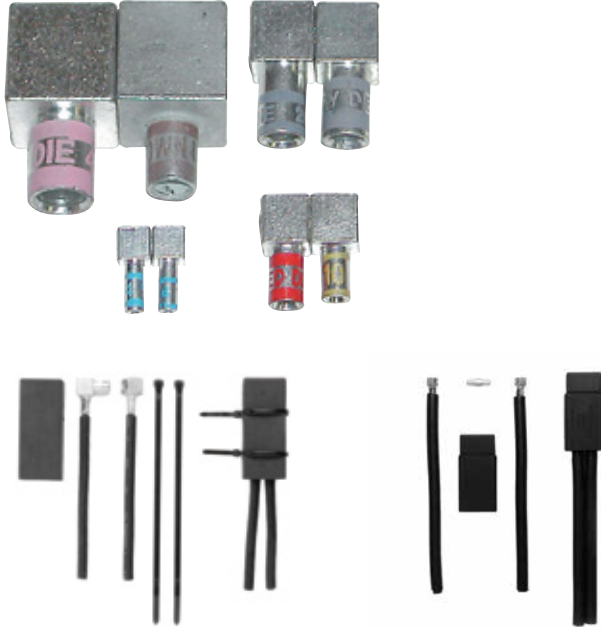

600 V version

5 kV version

Quick, easy installation!

- 1) Choose appropriate Blackburn® disconnect for conductor size to be terminated. Note color of bands on disconnect barrel.
- 2) Select proper installing die by matching die color to disconnect barrel color bands.
- 3) Install die in T&B tool, insert stripped wire into barrel of disconnect and compress between color bands. Repeat for mating half.
- 4) Snap the two halves together and slip on insulator over mated connection. Secure insulator with Ty-Rap® cable ties provided with the insulators.

Material – High-conductivity cast copper

Plating – Tin

Insulator – Thermoplastic elastomer

Motor pigtail connector – One line to one load (2 wire)



Installing tools

Cat. no.	Female disconnect	Male disconnect	WT112M WT111M WT2000 ERG4002	TBM6, TBM6S		TBM5, TBM5S	TBM8, TBM8S	Hydraulic tools		
				TBM45S	Upper die	Lower die	Die set	Die set	Die code	Color
MD1614F-0	MD1614M-0		Blue	-	-	-	-	-	-	
MD1614F-1	MD1614M-1			-	-	-	-	-	-	
MD1210F-1	MD1210M-1		Yellow	-	-	-	-	-	-	
MD1210F-2	MD1210M-2			-	-	-	-	-	-	
MD8F-1	MD8M-1	-		X	13475	13477	13454	13461	21	Red
MD8F-2	MD8M-2	-		X	13475	13477	13454	13461	21	
MD6F-1	MD6M-1	-		X	13475	13477	13454	13461	24	Blue
MD6F-2	MD6M-2	-		X	13475	13477	13454	13461	24	
MD4F-2	MD4M-2	-		X	13472	13476	13454	13461	29	Gray
MD2F-2	MD2M-2	-		X	13474	13477	13454	13461	33	Brown
MD2F-3	MD2M-3	-		X	13474	13477	13454	13461	33	
MD1F-2	MD1M-2	-		-	13474	13477	13455	13462	37	Green
MD1F-3	MD1M-3	-		-	13474	13477	13455	13462	37	
MD10F-3	MD10M-3	-		-	13475	13477	13455	13462	42	Pink
MD20F-3	MD20M-3	-		-	13474	13477	13455	13462	45	Black
MD30F-3	MD30M-3	-		-	13474	13477	13455	13462	50	Orange
MD40F-3	MD40M-3	-		-	13475	13477	13456	13463	54	Purple
MD40F-4	MD40M-4	-		-	13475	13477	13456	13463	54	
MD250F-4	MD250M-4	-		-	13473	13476	13456	13463	62	Yellow
MD350F-4	MD350M-4	-		-	13472	13476	13458	13466	71H	Red
MD500F-4	MD500M-4	-		-	13478	13478	13458	13468	87H	Brown

Specifications: wire range: #16 to 4/0 AWG. Rating: 600 V, 90 °C. Tooling – see pages 104-127. Die selector chart – see pages 128-133.

Motor pigtail connectors

Motor pigtail connector – One line to two load (3 wire)



- KON-TOUR™ louvered contact bands
 - Color coded to match installing dies
- Material** – High-conductivity wrought copper
Finish – Electro-tin plate



Motor pigtail connector – One line to two load (3 wire)

Cat. no.	Female disconnect	Male disconnect	Wire size (AWG)	Body size	Color code	Boot insulation	Dimensions (in.)						Strip length (in.)
							A	B	C	D	E	F	
MD1614F-0	M2D1614M-0	#16-#14	0	Blue	MDBOOT-1	0.250	0.250	0.63	0.77	0.25	0.12	3/8	
MD1210F-1	M2D1210M-1	#12-#10	1	Yellow	M2DBOOT-1	0.380	0.380	0.780	0.750	0.380	0.25	3/8	
MD1210F-2	M2D1210M-2	#12-#10	2	Yellow	M2DBOOT-2	0.500	0.500	0.900	1.500	0.500	0.37	3/8	
MD8F-1	M2D8M-1	#8	1	Red	M2DBOOT-1	0.380	0.380	0.820	1.125	0.380	0.25	7/16	
MD8F-2	M2D8M-2	#8	2	Red	M2DBOOT-2	0.500	0.500	0.950	1.500	0.500	0.37	7/16	
MD6F-1	M2D6M-1	#6	1	Blue	M2DBOOT-1	0.380	0.380	0.875	1.125	0.380	0.25	1/2	
MD6F-2	M2D6M-2	#6	2	Blue	M2DBOOT-2	0.500	0.500	1.020	1.500	0.500	0.37	1/2	
MD4F-2	M2D4M-2	#4	2	Gray	M2DBOOT-2	0.500	0.500	1.060	1.500	0.500	0.37	1/2	
MD2F-2	M2D2M-2	#2	2	Brown	M2DBOOT-2	0.500	0.500	1.090	1.500	0.500	0.37	17/32	
MD2F-3	M2D2M-3	#2	3	Brown	M2DBOOT-3	0.875	0.875	1.460	2.630	0.875	0.50	17/32	
MD1F-2	M2D1M-2	#1	2	Green	M2DBOOT-2	0.50	0.50	1.230	1.500	0.500	0.37	9/16	
MD1F-3	M2D1M-3	#1	3	Green	M2DBOOT-3	0.875	0.875	1.560	2.630	0.875	0.50	9/16	
MD10F-3	M2D10M-3	1/0	3	Pink	M2DBOOT-3	0.875	0.875	1.560	2.630	0.875	0.50	9/16	
MD20F-3	M2D20M-3	2/0	3	Black	M2DBOOT-3	0.875	0.875	1.590	2.630	0.875	0.50	9/8	
MD30F-3	M2D30M-3	3/0	3	Orange	M2DBOOT-3	0.875	0.875	1.710	2.630	0.875	0.50	11/16	
MD40F-3	M2D40M-3	4/0	3	Purple	M2DBOOT-3	0.875	0.875	1.810	2.630	0.875	0.50	3/4	

Diagrams

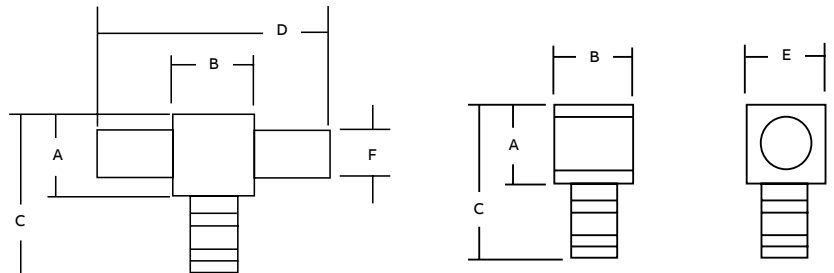

Operating range: 600 V max., 1000 V max. In signs and fixtures.

Listing: UL® listed and CSA certified for #12-#8 AWG solid copper conductors and stranded copper conductors in the sizes shown.

Selection: always use the same body size when selecting male and female disconnects. For example, to connect a #2 AWG male to a #8 AWG female, select catalog numbers M2D2M-2 and MD8F-2. Both have body size 2.

Insulation – use insulating boots matching the disconnect body size as indicated in the chart. To protect the connection from moisture and dirt, use sealing compound (catalog number MDBOOT-SEAL).

Tooling – see pages 104-127.

Die selector chart – see pages 128-133.

Motor pigtail connectors

Motor pigtail connector – One line to two load (3 wire) (continued)

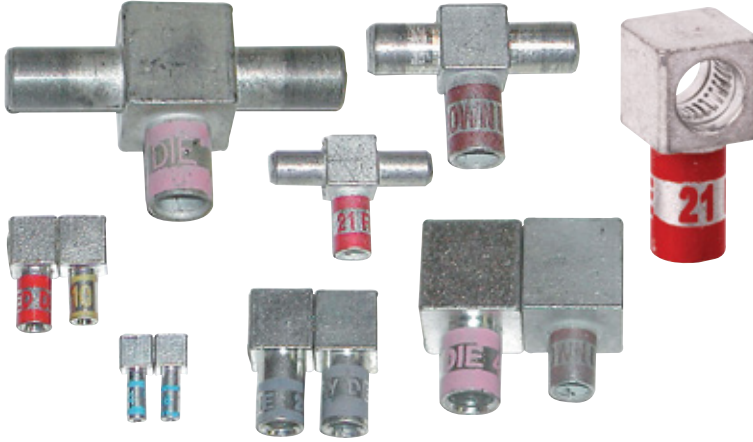

- KON-TOUR™ louvered contact bands
 - Color coded to match installing dies
- Material** – High-conductivity wrought copper
Finish – Electro-tin plate

Motor pigtail connector – One line to two load (3 wire)



Cat. no.	Female disconnect	Male disconnect	WT112M WT111M ERG4002 WT2000	TBM255	Upper die	TBM6 TBM6S Lower die	TBM5 TBM5S Die set	TBM8 TBM8S Die set	Installing tools	
									Die code	Color
MD1614F-0	M2D1614M-0		Blue	-	-	-	-	-	-	-
MD1210F-1	M2D1210M-1			-	-	-	-	-	-	-
MD1210F-2	M2D1210M-2		Yellow	-	-	-	-	-	-	-
MD8F-1	M2D8M-1			X	13475	13477	13454	13461	21	Red
MD8F-2	M2D8M-2			X	13475	13477	13454	13461	21	
MD6F-1	M2D6M-1			X	13475	13477	13454	13461	24	Blue
MD6F-2	M2D6M-2			X	13475	13477	13454	13461	24	
MD4F-2	M2D4M-2			X	13472	13476	13454	13461	29	Gray
MD2F-2	M2D2M-2			X	13474	13477	13454	13461	33	Brown
MD2F-3	M2D2M-3			X	13474	13477	13454	13461	33	
MD1F-2	M2D1M-2			-	13474	13477	13455	13462	37	Green
MD1F-3	M2D1M-3			-	13474	13477	13455	13462	37	
MD10F-3	M2D10M-3			-	13475	13477	13455	13462	42	Pink
MD20F-3	M2D20M-3			-	13474	13477	13455	13462	45	
MD30F-3	M2D30M-3			-	13474	13477	13455	13462	50	Orange
MD40F-3	M2D40M-3			-	13475	13477	13456	13463	54	Purple

Diagrams

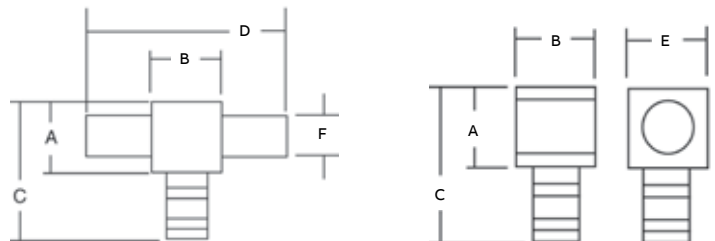

Tooling – see pages 104-127.

Die selector chart – see pages 128-133.

Motor pigtail connectors

5 kV motor pigtail connector supplied with boot, pin, silicon gel (two female connectors required)



5 kV motor pigtail connector supplied with boot, pin, silicon gel (two female connectors required)



Cat. no.	Wire range (AWG)	Female disconnect Cat. no.	Color code	Dimensions (in.)			Body size
				L	W	H	
5KVBOOT-2L	#8	MD8F-2	Red	4.50	2.25	1.44	2
5KVBOOT-2L	#6	MD6F-2	Blue	4.50	2.25	1.44	2
5KVBOOT-2L	#4	MD4F-2	Gray	4.50	2.25	1.44	2
5KVBOOT-2L	#2	MD2F-2	Brown	4.50	2.25	1.44	2
5KVBOOT-2L	#1	MD1F-2	Green	4.50	2.25	1.44	2
5KVBOOT-3L	#2	MD2F-3	Brown	4.50	2.25	1.44	3
5KVBOOT-3L	#1	MD1F-3	Green	4.50	2.25	1.44	3
5KVBOOT-3L	1/0	MD10F-3	Pink	4.50	2.25	1.44	3
5KVBOOT-3L	2/0	MD20F-3	Black	4.50	2.25	1.44	3
5KVBOOT-3L	3/0	MD30F-3	Orange	4.50	2.25	1.44	3
5KVBOOT-3L	4/0	MD40F-3	Purple	4.50	2.25	1.44	3

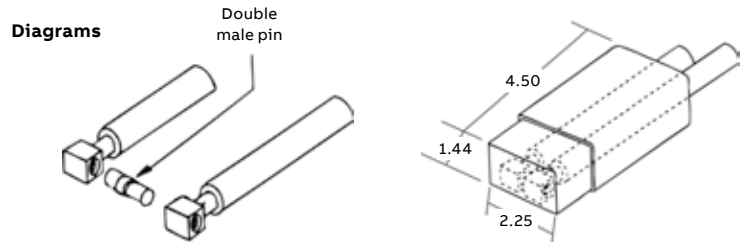

Sealant



For easy, reliable sealing of motor disconnect boots.

Sealant should be used with T&B motor disconnect boots: MDBOOT-0, MDBOOT-1, MDBOOT-2 AND MDBOOT-3.

The cable should be clean and free of grease and other foreign substances.

Apply two layers around each cable at the same distance from the connector.

Slide the assembly into boot, apply Ty-Rap® cable ties and work sealant around wires at end of boot to eliminate voids.

Specifications

- Description: polybutene compound
- Application temperature: 40 °F to 100 °F
- Service temperature: -40 °F to 180 °F
- Dimensions: width 1", thickness 3/8", length (std. Roll) 10', wrapped on release liner
- Environmental resistance: resists normal aging process
- Chemical resistance: resists acids, bases and alcohols
- Dielectric strength: 200 V/mil minimum
- Volume resistivity: 1013 ohms/cm
- Flame retardancy: pass VO vertical flame test

Sealant

Cat. no.	Description
MDBOOT-SEAL	Sealant

Diagrams

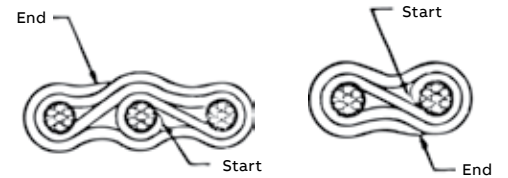

For watertight applications, contact technical services.

Tooling – see pages 104-127.

Die selector chart – see pages 128-133.

Kube[®] connectors

Make economical, field-constructible, UL[®] listed multiple-tap electrical connections!

—
01 This multi-tap installation connects 4/0, #1 and #2 AWG cables using MD40F-3, MD1F-3 and MD2F-3 connectors with REC-3 insulators on an R3-6 rod.

Kube connectors multi-tap

Leave it to Thomas & Betts to bring you the most versatile, affordable solution for multiple-load installations from a single main conductor. The Kube multi-tap system gangs multiple permanent, dependable compression taps mounted on a high-conductivity copper rod to achieve a space- and cost-efficient UL listed multiple-tap connection you configure in the field. For even more flexibility, you can rotate connectors individually on the multi-tap rod to accommodate the bends and angles necessary to install equipment or complete circuitry – without the high cost of flexible-conductor cable.

- Lowest installed cost for the application – eliminates the need for expensive flexible-conductor cable
- Individual connectors can be rotated 360° on rod for multi-directional connections
- Versatile, modular design supports a myriad of connection possibilities
- UL 486AB listed and CSA certified for field installation

- Compression connections maintain integrity even under vibration and high temperatures
- Supports wire sizes from #16 to 4/0 AWG
- Suitable for applications up to 600 V (1000 V in signs and fixtures)
- Rods constructed of high-conductivity copper with corrosion-resistant tin plating
- Connectors constructed of electro-tin plated high conductivity copper with louvered contact bands for reliable connections and color coding for easy selection of crimping die
- Two-piece, UL94-V0-rated, polycarbonate insulators snap onto connectors easily for fast, safe installation

Typical applications

- Commercial construction
- Specialized installations for entertainment applications
- Gutter taps for all applications
- Any other application requiring the running of multiple loads from a main conductor



—
01

Kube® connectors

How to order Kube multi-tap

—
01 Crimp multi-tap connectors onto de-energized cables.

—
02 Snap multi-tap insulators over connectors.

—
03 Remove one end nut and spacers from multi-tap rod.

—
04 Slide connector/insulator assemblies onto rod.

—
05 If any rod positions remain empty, slide on appropriate number of spacers to fill rod.

—
06 Reapply end nut and tighten.

KUBE Multi-Tap makes field installation fast and easy.

How to order Kube multi-tap

- Choose your connectors. Note that connectors to be mounted on a single multi-tap rod can be for different wire sizes but must be of the same body size.

Kube multi-tap connectors



Cat. no.	Wire size (AWG)	Body size	Color code
MD1614F-0	#16-#14	0	Blue
MD1614F-1	#16-#14	1	Blue
MD1210F-1	#12-#10	1	Yellow
MD1210F-2	#12-#10	2	Yellow
MD8F-1	#8	1	Red
MD8F-2	#8	2	Red
MD6F-1	#6	1	Blue
MD6F-2	#6	2	Blue
MD4F-2	#4	2	Gray
MD2F-2	#2	2	Brown
MD2F-3	#2	3	Brown
MD1F-2	#1	2	Green
MD1F-3	#1	3	Green
MD10F-3	1/0	3	Pink
MD20F-3	2/0	3	Black
MD30F-3	3/0	3	Orange
MD40F-3	4/0	3	Purple

Please note that these connectors are the same as our female motor pigtail connectors.

For more information on dimensions, compression tool selection and required strip length, see pages 63-66.

Kube multi-tap insulators

One insulator required for each connector.



Cat. no.	For connector body size
REC-0	0
REC-1	1
REC-2	2
REC-3	3

- Choose insulators of the appropriate body size for the connectors. (One insulator required for each connector.)
- Choose a multi-tap rod that matches the body size of your connectors and that has enough positions for the number of connections you need.

Kube multi-tap rods

Includes rod with spacers and end nuts. Rod positions indicate the maximum number of connectors the rod can hold. Spacers are provided to fill any unused positions left open for future connections. Body size of connectors, insulators and rod must match.

Cat. no.	For connector body size	No. of rod positions
R0-4	0	4
R0-6	0	6
R0-8	0	8
R0-10	0	10
R0-12	0	12
R1-4	1	4
R1-6	1	6
R1-8	1	8
R1-10	1	10
R1-12	1	12
R2-4	2	4
R2-6	2	6
R2-8	2	8
R2-10	2	10
R2-12	2	12
R3-4	3	4
R3-6	3	6
R3-8	3	8
R3-10	3	10
R3-12	3	12



01



02



03



04



05



06

KUBE® connectors

KUBE flag, tee and cross connectors



A cost-saving breakthrough in 90°, T and cross connections.

Finally there's a fast, easy and affordable way to make those 90°, T and cross electrical connections whenever and wherever you need them. Blackburn® flags, tees and crosses are designed – and UL®/CSA approved – to be used with standard Blackburn® lugs and splices featuring the Color-Keyed® system in field-assembled configurations. Now you don't need to use high-cost flexible conductor for connections requiring 90° bending radius or expensive brazed or welded connectors for T or cross connections!

- Offers lowest installed cost for the application
- Versatile, modular design enables thousands of field-constructible connection possibilities, including multi-circuit configurations
- Insulated for fast, safe termination and installation Used with standard Blackburn lugs and splices featuring the Color-Keyed system
- Color coded for easy selection of correct crimping die and easy verification of proper crimp

Flags, tees and crosses



Cat. no.	Wire size (AWG or kcmil)	Insulator	Std. pkg. qty.
Flags			
FLAG1614	#16–#14	F-INSUL-0	20
FLAG1210	#12–#10	F-INSUL-0	10
FLAG8	#8	F-INSUL-1	10
FLAG6	#6	F-INSUL-1	10
FLAG4	#4	F-INSUL-2	6
FLAG2	#2	F-INSUL-2	6
FLAG1	#1	F-INSUL-2	6
FLAG10	1/0	F-INSUL-3	3
FLAG20	2/0	F-INSUL-3	3
FLAG30	3/0	F-INSUL-3	3
FLAG40	4/0	F-INSUL-3	3
Flag250	250	F-INSUL-4	3/15
Flag350	350	F-INSUL-4	3/15
Flag500	500	F-INSUL-4	3/15

Cat. no.	Wire size (AWG or kcmil)	Insulator	Std. pkg. qty.
Tees			
TEE1614	#16–#14	–	20
TEE1210	#12–#10	–	10
TEE8	#8	–	3
TEE6	#6	–	10
TEE4	#4	–	6
TEE2	#2	–	6
TEE1	#1	–	6
TEE10	1/0	–	3
TEE20	2/0	–	3
TEE30	3/0	–	3
TEE40	4/0	–	3
TEE250	250	–	3/15
TEE350	350	–	3/15
TEE500	500	–	3/15

Cat. no.	Wire size (AWG or kcmil)	Insulator	Std. pkg. qty.
Crosses			
CROSS1614	#16–#14	–	20/200
CROSS1210	#12–#10	–	10/100
CROSS8	#8	–	10/100
CROSS6	#6	–	10/100
CROSS4	#4	–	6/60
CROSS2	#2	–	6/60
CROSS1	#1	–	6/60
CROSS10	1/0	–	3/30
CROSS20	2/0	–	3/30
CROSS30	3/0	–	3/30
CROSS40	4/0	–	3/30

KUBE® connectors

Flag insulators & Flag and tee kit



A cost-saving breakthrough in 90°, T and cross connections.

Flag and tee kit contents:

- Steel carrying case
- TBM25S crimp tool
- 25 each #8, #6 and #4 AWG flag bodies
- 25 each #8, #6 and #4 AWG one-hole lugs
- 10 each #2, #1, 1/0, 2/0, 3/0 and 4/0 AWG flag bodies
- 10 each #2, #1, 1/0, 2/0, 3/0 and 4/0 AWG one-hole lugs
- 50 size 1 flag insulators
- 45 size 2 flag insulators
- 40 size 3 flag insulators
- 10 each #8 and #6 AWG tee bodies
- 20 each #8 and #6 AWG two-way splices
- 6 each #4, #2 and #1 AWG tee bodies
- 12 each #4, #2 and #1 AWG two-way splices
- 3 each 1/0, 2/0, 3/0 and 4/0 AWG tee bodies
- 6 each 1/0, 2/0, 3/0 and 4/0 AWG two-way splices

Specifications

- Connector: Tin-plated copper
- Insulation: Halogen-free polypropylene
- Standards: UL 486, CSA 22.2 #65

Flag insulators

Cat. no.	Description	Std. pkg. qty.
F-INSUL-0	For #16-#10 AWG	20/200
F-INSUL-1	For #8, #6 AWG	10/100
F-INSUL-2	For #4, #2, #1 AWG	6/60
F-INSUL-3	For 1/0, 2/0, 3/0, 4/0 AWG	3/30
F-INSUL-4	For 250, 350, 500 kcmil	10/50

Flag and tee kit

Cat. no.	Description	Std. pkg. qty.
FLAGTEEKIT	Flag and tee kit	1

Tooling – see pages 104-127.

Die selector chart – see pages 128-133.

Copper disconnects

High-amperage quick power disconnects



Making connections for high-amperage loads has never been easier!

- Designed to be the fastest “off-load” connection possible, while maintaining system integrity
- Uses a multicontact approach to provide low insertion and extraction forces with low resistance and temperature rise
- Enables multiple connections and disconnections without changing or degrading performance characteristics
- Unique construction:
 - Made from 99.9% conductive copper, silver plated
 - Contact design features louvered band of beryllium copper
 - All raised edges of louvered band are deflected, producing a multitude of high-force contact points
 - Each contact point is typically in the force range of 8,000 to 10,000 psi
 - High currents, caused by short circuits or sudden surges, make contact interface even more efficient by increasing contact pressure

High-amperage quick power disconnects

Cat. no.		Conductor (kcmil)	Die code
Male	Female		
272-32175M	272-32175F	777	115
Future design	-	646	-
Future design	-	535	-
Future design	-	444	-

Diagram

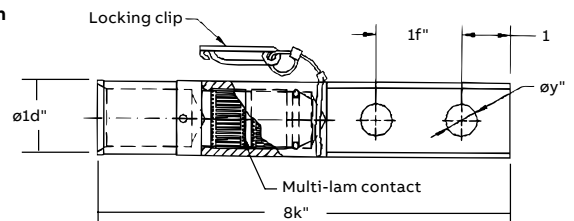

Tooling – see pages 104-127.
 Die selector chart – see pages 128-133.

Copper disconnects

T&B method traction motor disconnect lugs for diesel-electric locomotives

Making connections for high-amperage loads
has never been easier!

T&B method traction motor disconnect lugs for diesel-electric locomotives

Cat. no.	Cable size	Dimensions (in.)				E Approx. (In.)	Bolt size (in.)				Die code
		A	B	C	D		F	G	H		
MD37	37/24	2 ⁷ / ₁₆	1 ³ / ₄	1 ⁹ / ₃₂	5 ⁵ / ₃₂	3 ⁷ / ₈	3 ⁷ / ₈	5 ⁵ / ₁₆	7 ⁷ / ₈	26	
MDD61	61/24	2 ⁷ / ₁₆	1 ³ / ₄	1 ⁹ / ₃₂	5 ⁵ / ₃₂	3 ⁷ / ₈	3 ⁷ / ₈	5 ⁵ / ₁₆	7 ⁷ / ₈	26	
MD 105	105/24	2 ⁵ / ₈	1 ³ / ₄	1 ⁹ / ₃₂	5 ⁵ / ₃₂	7 ¹ / ₁₆	3 ⁷ / ₈	5 ⁵ / ₁₆	7 ⁷ / ₈	33	
MD 105	91/24	2 ⁵ / ₈	1 ³ / ₄	1 ⁹ / ₃₂	5 ⁵ / ₃₂	7 ¹ / ₁₆	3 ⁷ / ₈	5 ⁵ / ₁₆	7 ⁷ / ₈	33	
MD 125	125/24	2 ⁵ / ₈	1 ³ / ₄	1 ⁹ / ₃₂	5 ⁵ / ₃₂	7 ¹ / ₁₆	3 ⁷ / ₈	5 ⁵ / ₁₆	7 ⁷ / ₈	33	
MD 150	150/24	2 ¹⁵ / ₁₆	1 ⁷ / ₈	1 ⁹ / ₃₂	0.203	5 ⁵ / ₈	7 ¹ / ₁₆	5 ⁵ / ₁₆	7 ⁷ / ₈	45	
MD 175	175/24	2 ¹⁵ / ₁₆	1 ⁷ / ₈	1 ⁹ / ₃₂	0.203	5 ⁵ / ₈	7 ¹ / ₁₆	5 ⁵ / ₁₆	7 ⁷ / ₈	45	
MD 225	225/24	3	1 ⁷ / ₈	1 ¹¹ / ₁₆	0.203	2 ³ / ₃₂	7 ¹ / ₁₆	5 ⁵ / ₁₆	7 ⁷ / ₈	54	
MD 275	275/24	3	1 ⁷ / ₈	1 ¹¹ / ₁₆	0.203	2 ³ / ₃₂	7 ¹ / ₁₆	5 ⁵ / ₁₆	7 ⁷ / ₈	54	
MD 325	325/24	3	1 ⁷ / ₈	1 ¹¹ / ₁₆	0.203	2 ³ / ₃₂	7 ¹ / ₁₆	5 ⁵ / ₁₆	7 ⁷ / ₈	54	
MD 375	375/24	3 ¹ / ₈	2	2 ⁵ / ₃₂	0.203	2 ³ / ₃₂	7 ¹ / ₁₆	5 ⁵ / ₁₆	7 ⁷ / ₈	60	
MD 450	450/24	3 ¹ / ₈	2	2 ⁵ / ₃₂	0.203	2 ³ / ₃₂	7 ¹ / ₁₆	5 ⁵ / ₁₆	7 ⁷ / ₈	60	
MD 550	550/24	3 ³ / ₁₆	1 ⁷ / ₈	1 ⁵ / ₁₆	0.203	1	7 ¹ / ₁₆	5 ⁵ / ₁₆	7 ⁷ / ₈	76	
MD 650	650/24	3 ³ / ₁₆	1 ⁷ / ₈	1 ⁵ / ₁₆	0.203	1	7 ¹ / ₁₆	5 ⁵ / ₁₆	7 ⁷ / ₈	76	
MD 775	775/24	3 ³ / ₁₆	1 ⁷ / ₈	1 ⁵ / ₁₆	0.203	1	7 ¹ / ₁₆	5 ⁵ / ₁₆	7 ⁷ / ₈	76	
MD 925	925/24	3 ³ / ₄	2 ¹ / ₁₆	1 ¹ / ₈	0.375	1 ⁵ / ₃₂	7 ¹ / ₁₆	3 ⁷ / ₈	1	87	
MD 1100	1100/24	3 ³ / ₄	2 ¹ / ₁₆	1 ¹¹ / ₃₂	0.375	1 ³ / ₈	7 ¹ / ₁₆	3 ⁷ / ₈	1	107	
MD 1325	1325/24	3 ²⁵ / ₃₂	2 ³ / ₃₂	1 ⁵ / ₃₂	0.375	1 ³ / ₄	7 ¹ / ₁₆	3 ⁷ / ₈	1	107	
MD 1600	1600/24	3 ³ / ₄	2 ¹ / ₁₆	1 ¹¹ / ₃₂	0.375	1 ³ / ₈	7 ¹ / ₁₆	3 ⁷ / ₈	1	107	
MD 1925*	1925/24	4 ¹ / ₁₆	2 ³ / ₃₂	1 ¹¹ / ₃₂	0.375	1 ¹ / ₂	7 ¹ / ₁₆	3 ⁷ / ₈	1	115	
MD 2300	2300/24	4 ³ / ₈	2 ¹ / ₈	1 ¹⁹ / ₃₂	0.375	1 ²¹ / ₃₂	7 ¹ / ₁₆	3 ⁷ / ₈	1	130	

Diagrams

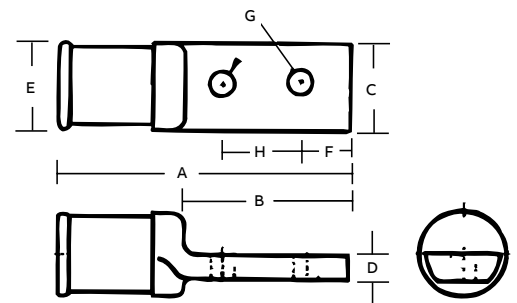
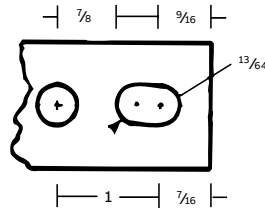

Note: Some parts may not be current on the system. Contact tech services for information.

* MD 1925 supplied with elongated bolt hole.

Tooling – see pages 104-127.

Die selector chart – see pages 128-133.

Connector kits

Connector kit for copper cables



Connector kit for copper cables

Cat. no.	Description	Std. pkg.	Wt. each
TBM2K-1	Color-Keyed® connector kit	1	12

Kit includes

Cat. no.	Items	Cable size (AWG)		Qty.
54104	One-hole lugs	#8		25
54105	One-hole lugs	#6		25
54106	One-hole lugs	#4		15
54107	One-hole lugs	#2, #3		10
54504	2-Way splice connectors	#8		15
54505	2-Way splice	#6		15
54506	2-Way splice	#4		10
54507	2-Way splice	#2		5
		Min.	Max.	
54610	Pigtails	3-#12	#4-#12	15
54615	Pigtails	#4-#12	#4-#10	15
54620	Pigtails	#3-#8	#1-#4	15
		#10	#10	
54710	C-taps	#8	#12	15
		#6	#10-#12	
54615	C-taps	#8	#8-#10	15
		#4 or #5	#8-#10-#12	
54720	C-taps	#6	#6-#8	-
TBM20S or TBM45S	Manual crimp tool	#8	#2	1

UL not applicable

Connector kits

Carrying cases



MDKITL

Carrying cases

MDPWK12 Case contents

(1) PWK1	(10) MD1210F-1	(6) MD8M-2	(6) MD8F-2	(30) BOOT-1
(10) MD1210M-1	(10) MD8F-1	(6) MD6M-2	(6) MD6F-2	(6) MD1210M-2
(10) MD8M-1	(10) MD6F-1	(6) MD4M-2	(6) MD4F-2	(6) MD1210F-2
(10) MD6M-1	(30) MDBOOT-2	(6) MD2M-2	(6) MD2F-2	-

MDPWK23 Case contents

(1) PWK1	(6) MD1210F-2	(3) MD2M-3	(3) MD2F-3	(6) MD1M-2
(6) MD1210M-2	(6) MD8F-2	(3) MD1M-3	(3) MD1F-3	(36) MDBOOT-2
(6) MD8M-2	(6) MD6F-2	(3) MD10M-3	(3) MD10F-3	(18) MDBOOT-3
(6) MD6M-2	(6) MD4F-2	(3) MD20M-3	(3) MD20F-3	-
(6) MD4M-2	(6) MD2F-2	(3) MD30M-3	(3) MD30F-3	-
(6) MD2M-2	(6) MD1F-2	(3) MD40M-3	(3) MD40F-3	-

MDKITL Case contents

(1) PWK1	(1) TBM25S	(24) MDBOOT-2	(3) M2D2M-2	(6) MD8M-1
(3) M2D4M-2	(3) M2D6M-2	(3) M2D8M-2	(12) M2DBOOT-2	(6) MD8F-1
(12) MDBOOT-1	(12) MD2F-2	(12) MD4F-2	(12) MD6F-2	(6) MD8M-2
(12) M2D8F-2	(6) MD2M-2	(6) MD4M-2	(6) MD6M-2	(6) MD6M-1
(6) MD6F-1	-	-	-	-

Cat. no.	Description
PWK1	Empty case – includes wall chart; make up your own selection of Blackburn® lugs, splices, taps or motor disconnects featuring the Color-Keyed® system.
PWK4	Metal cabinet that holds four of the PWK1 shells that slide out for easy removal.
MDPWK12	Selection of size 1 and 2 male and female motor disconnects plus insulators; to connect 60 single line to single load motor leads, #12 AWG through #2 AWG; tools not included.
MDPWK23	Selection of size 2 and 3 male and female motor disconnects plus insulators; to connect 54 single line to single load motor leads, #12 AWG through #4/0 AWG; tools not included. Size 2 and 1 male and female motor disconnects plus insulators; to convert single to single line or single line to two line.
MDKITL	Includes tool.

Joint compound

Kopr-Shield® joint compound

Copper colloidal surface treatment protects, lubricates and enhances conductivity of all electrical connections.

- Unique, homogenized blend of pure, polished colloidal copper, rust and corrosion inhibitors
- Simultaneously protects, lubricates and enhances conductivity of mating surfaces
- Extremely adhesive compound flows smoothly into uneven contours and voids, ensuring easy application and complete, positive protection and lubrication
- Won't settle-out, thin, thicken, harden or dry out under the most severe environmental conditions
- Excellent temperature characteristics – can be brushed on at -50 °F to 250 °F (other compounds either turn solid or run like water at these extremes) and remains intact at short terms even at 1,800 °F

Good connections are one of the most important aspects of electrical work. Mechanics know how much downtime is caused when fluids or oils leak into the raceway system or when they have to look for a weak link in a ground system caused by a high-resistance connection. Mechanics also know how much time is spent keeping contacts, switches, lugs and other connectors clean or replacing parts because of “green scourge” buildup. Thomas & Betts has the solution to improve connections made in thousands of

electrical and raceway installations made each day by electricians everywhere. Kopr-Shield compound may be used to your advantage in all electrical installations. When the environment is hostile to electrical and mechanical connections, Kopr-Shield compound is a must!

Use Kopr-Shield compound for battery lugs and cables to:

- Prevent “green scourge” corrosion
- Reduce resistance
- Ease terminal installation and removal

Use Kopr-Shield compound for raceways to:

- Lubricate for ease of assembly and disassembly
- Improve grounding continuity (exceeds code requirements)

Use Kopr-Shield compound for fuse clips to:

- Eliminate hot spots for even heat distribution
- Prevent oxidation by preventing carbon path formation
- Lubricate for easy installation and removal of fuses

Use Kopr-Shield compound for wiping contacts, drum switches and slip rings to:

- Prevent galling, burning, pitting and discoloration
- Suppress arcing and dissipation of coronas
- Lubricate for ease of operation



Kopr-Shield joint compound



Cat. no.	Description	Std. pkg.	Wt. lbs./C
201-31879	1½-oz. Container with brush	96	11.46
201-31879-1	4-oz. Container with brush	24	38.54
CP8-TB	8-oz. Container with brush	12	64.58
CP16	16-oz. Container with brush	12	120.83
CP128	1-Gallon can	4	952.00

Joint compound

ALUMA-SHIELD® aluminum joint compound



Copper colloidal surface treatment protects, lubricates and enhances conductivity of all electrical connections.

ALUMA-SHIELD aluminum joint compound

Cat. no.	Contains	Description
21059	1-pt. Squeeze bottle	For aluminum cable connections; contains fine zinc particles which break through oxide film on cable strands upon compression of connection; ensures a low resistance contact and seals out air and moisture.
AP8	8-oz. Brush cap can	—
M53	5-Gallon can	—

Note: UL® Listed only for use on electrical cables in cable connector assemblies, or on bus bars rated for NEC® applications up to 8 kV and 90 °C.
NEC and National Electrical Code are registered trademarks of the National Fire Protection Association, Inc.

Connectors for aluminum/copper code conductor

Belleville compression washers



For tight, secure bus-bar connections.

- Essential when bolting aluminum lugs and connectors to bus bars with steel or brass hardware
- Maintains constant pressure in heavy-duty, high-temperature applications
- Available with or without flat washer

- When bolting aluminum lugs and connectors to bus bars with steel or brass hardware, the recommended practice to ensure a tight connection is to use a Belleville spring washer on top of a flat washer under the bolt head or nut. For heavy-duty service where the heat rise is expected to exceed 30 °C above ambient, this procedure maintains constant pressure as the connector metals expand and contract with temperature changes.

Belleville compression washers

Cat. no.	Bolt size (in.)	A	Flat washer		Dimensions (in.)	
			B	C	Belleville washer	D
Belleville compression washers plus flat washer						
60800B	1/4	3/4	0.067	11/16	0.055	
60801B	5/16	7/8	0.074	13/16	0.065	
60802B	3/8	1	0.083	15/16	0.075	
60803B	1/2	1 1/4	0.109	13/16	0.095	
Belleville compression washer only						
60800	1/4	–	–	11/16	0.055	
60801	5/16	–	–	13/16	0.065	
60802	3/8	–	–	15/16	0.075	
60803	1/2	–	–	13/16	0.095	
60804	5/8	–	–	1 1/2	0.110	

Diagram

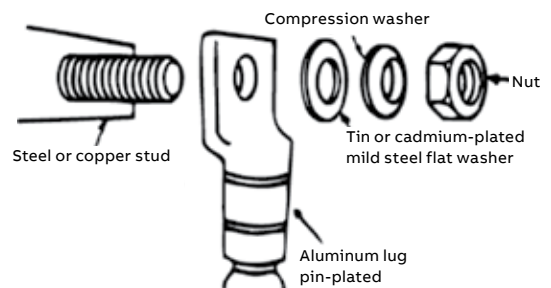

Note: Ordering quantity must be in unit quantities and multiples thereof. The Belleville washer should be installed with a larger flat washer to spread the high stresses of the spring washer edges over a large area of the lug and/or bus bar.

Connectors for aluminum/copper code conductor

Dragon Tooth® transition washers



Quick, dependable and versatile.

- Connect copper-to-aluminum, copper-to-copper or aluminum-to-aluminum component
- Toothed surface penetrates aluminum and copper oxides
- Lower installed cost – no need to grind aluminum surfaces, apply compounds or use spring-type washers

Dragon Tooth transition washers

Cat. no.	Size (in.)	Bolt torque (in lbs.)
DTW14	¼	50–80
DTW516	5/16	125–160
DTW38	3/8	160–240
DTW12	½	390–540
DTW58	5/8	540–730

Connectors for aluminum/copper code conductor

One-hole lugs



Perform equally well on both aluminum and copper conductors.

- For 90 °C, 600 V to 35 kV applications
- Easily matched to the correct Blackburn® installing die featuring the Color-Keyed® system for positive compressions
- Hardened steel dies compress connector around cable, changing round strands to polygonal shapes and cold flowing strands and connector into a solid, homogeneous mass
- Long compression areas ensure complete contact
- Multiple compressions prevent creep of aluminum conductors
- Filled with high-temperature oxide-inhibitor compound
- Electro-tin plating prevents electrolytic corrosion of copper to ensure lowest contact resistance

Material – High-conductivity wrought aluminum

Finish – Electro-tin plate

One-hole lugs



Cat. no.	Cable size Al/Cu (AWG or kcmil)	Bolt size (in.)	Dimensions (in.)						Color code	Die code
			A	B	C	D	E	F		
60096	#10	#10	1.09	0.56	0.41	0.06	0.270	0.22	21	Red
60097		1/4	1.31	0.72	0.43	0.07	0.270	0.34		
60099		3/8	1.53	0.93	0.58	0.06	0.270	0.44		
60101	#8	#10	1.22	0.56	0.41	0.09	0.280	0.22	24	Blue
60102		1/4	1.38	0.71	0.44	0.09	0.280	0.34		
60103		5/16	1.56	0.91	0.60	0.06	0.280	0.44		
60104-TB		3/8	1.60	0.93	0.60	0.06	0.280	0.44		
60106	#6	#10	1.52	0.59	0.47	0.13	0.350	0.22	29	Gray
60107		1/4	1.67	0.75	0.47	0.13	0.350	0.34		
60108		5/16	1.83	0.91	0.63	0.09	0.350	0.44		
60109		3/8	1.86	0.93	0.63	0.09	0.350	0.44		
60112	#4	1/4	1.81	0.75	0.64	0.19	0.460	0.34	37	Green
60113		5/16	2.00	0.91	0.64	0.19	0.460	0.44		
60114		3/8	2.03	0.93	0.64	0.19	0.460	0.44		
60116	#2	1/4	1.91	0.75	0.72	0.19	0.510	0.34	42	Pink
60117		5/16	2.06	0.91	0.72	0.19	0.510	0.44		
60118		3/8	2.09	0.93	0.72	0.19	0.510	0.44		
60120		1/2	2.25	1.41	0.88	0.13	0.510	0.69		
60122	#1	1/4	2.30	0.81	0.75	0.19	0.560	0.34	45	Gold
60123		5/16	2.39	0.91	0.75	0.19	0.560	0.44		
60124		3/8	2.42	0.93	0.75	0.19	0.560	0.44		
60126		1/2	2.89	1.41	0.88	0.16	0.560	0.69		
60128	1/0	1/4	2.36	0.81	0.88	0.19	0.620	0.34	50	Tan
60129		5/16	2.51	0.97	0.88	0.19	0.620	0.44		
60130		3/8	2.51	0.97	0.88	0.19	0.620	0.44		
60132		1/2	2.95	1.41	0.94	0.19	0.620	0.69		

Connectors for aluminum/copper code conductor

One-hole lugs (continued)

Perform equally well on both aluminum and copper conductors.



One-hole lugs

Cat. no.	Cable size Al/Cu (AWG or kcmil)	Bolt size (in.)	Dimensions (in.)						Color code	Die code
			A	B	C	D	E	F		
60134	2/0	1/4	2.48	0.87	0.97	0.22	0.700	0.34	54	Olive
60135		5/16	2.64	1.03	0.97	0.22	0.700	0.44		
60136		3/8	2.64	1.03	0.97	0.22	0.700	0.44		
60138		1/2	3.10	1.41	1.03	0.22	0.700	0.69		
60140	3/0	1/4	2.58	0.87	1.06	0.22	0.770	0.34	60	Ruby
60141		5/16	2.83	1.09	1.06	0.22	0.770	0.44		
60142		3/8	2.83	1.09	1.06	0.22	0.770	0.44		
60144		1/2	3.15	1.41	1.06	0.22	0.770	0.69		
60147	4/0	5/16	3.53	0.88	1.21	0.25	0.857	0.38	66	White
60148		3/8	3.58	0.93	1.21	0.25	0.857	0.38		
60150		1/2	3.90	1.25	1.21	0.25	0.857	0.50		
60151		5/8	4.65	2.00	1.21	0.25	0.857	0.75		
60154	250	3/8	3.73	0.93	1.29	0.27	0.917	0.38	71	Red
60156		1/2	4.05	1.25	1.29	0.27	0.917	0.50		
60157		5/8	4.80	2.00	1.29	0.27	0.917	0.75		
60159	300	5/16	3.75	0.88	1.39	0.28	0.990	0.38	76	Blue
60160		3/8	3.80	0.93	1.39	0.28	0.990	0.38		
60162		1/2	4.13	1.25	1.39	0.28	0.990	0.50		
60165	350	1/2	4.83	1.25	1.53	0.33	1.090	0.50	87	Brown
60166		5/8	5.58	2.00	1.53	0.33	1.090	0.75		
60168	400	1/2	4.95	1.25	1.65	0.38	1.180	0.50	94	Green
60171	500	1/2	4.95	1.25	1.79	0.38	1.280	0.50	99	Pink
60172		5/8	5.70	2.00	1.79	0.38	1.280	0.75		
60174	600	5/8	5.83	2.00	1.92	0.37	1.360	0.75	106	Black
60176	700	5/8	5.95	2.00	2.04	0.38	1.440	0.75	112	Purple
60178	750	5/8	6.03	2.00	2.13	0.40	1.500	0.75	115	Yellow
60184	1000	5/8	6.78	2.00	2.50	0.50	1.770	0.75	140	-

Diagrams

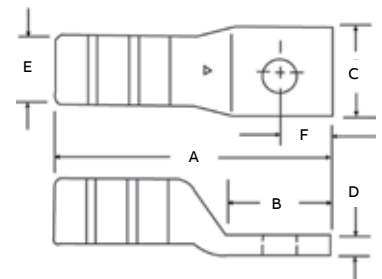

Tooling – see pages 104-127.

Die selector chart – see pages 128-133.

Connectors for aluminum/copper code conductor

Two-hole lugs



Designed and approved for use with both aluminum and copper conductors.

- For 90 °C, 600 V to 35 kV applications
- For aluminum and copper concentric conductors and compact code aluminum strandings
- Filled with oxide-inhibitor compound

Material – High-conductivity wrought aluminum

Finish – Electro-tin plate



Two-hole lugs

Cat. no.	Cable size (AWG or kcmil)	Bolt size (in.)	Dimensions (in.)								Die code	Color code
			A	B	C	D	E	F	G			
60230	1/0	3/8	3.50	1.90	0.880	0.19	0.62	0.38	1.00	50	Tan	
60236	2/0	3/8	3.50	1.90	0.970	0.22	0.70	0.38	1.00	54	Olive	
60238	2/0	1/2	5.03	3.41	0.970	0.22	0.70	0.75	1.75			
60242	3/0	3/8	3.66	1.18	1.063	0.22	0.77	0.38	1.00	60	Ruby	
60244	3/0	1/2	5.16	3.41	1.063	0.22	0.77	0.75	1.75			
60248	4/0	3/8	4.58	1.93	1.210	0.25	0.86	0.38	1.00	66	White	
60250	4/0	1/2	5.65	3.00	1.210	0.25	0.86	0.50	1.75			
60254	250	3/8	4.73	1.93	1.290	0.27	0.92	0.38	1.00	71	Red	
60256	250	1/2	5.80	3.00	1.290	0.27	0.92	0.50	1.75			
60260	300	3/8	4.80	1.93	1.390	0.28	0.99	0.38	1.00	76	Blue	
60262	300	1/2	5.88	3.00	1.390	0.28	0.99	0.50	1.75			
60265	350	3/8	5.50	1.93	1.530	0.33	1.09	0.38	1.00	87	Brown	
60267	350	1/2	6.58	3.00	1.530	0.33	1.09	0.50	1.75			
60268	400	3/8	5.63	1.93	1.650	0.38	1.18	0.38	1.00	94	Green	
60269	400	1/2	6.70	3.00	1.650	0.38	1.18	0.50	1.75			
60271	500	3/8	5.63	1.93	1.790	0.38	1.28	0.38	1.00	99	Pink	
60273	500	1/2	6.70	3.00	1.790	0.38	1.28	0.50	1.75			
60274	600	3/8	5.75	1.93	1.920	0.37	1.36	0.38	1.00	106	Black	
60275	600	1/2	6.83	3.00	1.920	0.37	1.36	0.50	1.75			
60276	700	3/8	5.88	1.93	2.040	0.38	1.44	0.38	1.00	112	Purple	
60277	700	1/2	6.95	3.00	2.040	0.38	1.44	0.50	1.75			
60278*	750	1/2	7.15	3.00	2.130	0.40	1.50	0.50	1.75	115	Yellow	
60284	1000	1/2	7.78	3.00	2.500	0.50	1.77	0.50	1.75	140	-	

Diagrams

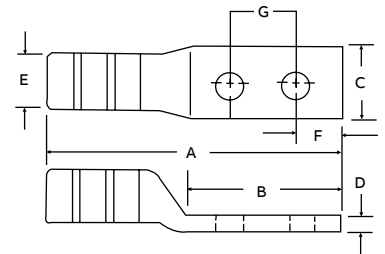

Note: Bolt holes 3/8" on 1" centers, 1/2" on 1 3/4" centers.

Connectors for aluminum/copper code conductor

Range-taking narrow-tongue single-barrel lugs



Wire barrel factory-filled with oxide-inhibiting compound.

- For 90 °C, 600 V to 35 kV applications
- 1½"-wide tongues
- Bolt holes on 1¾" centers

Material – Aluminum

Finish – Electro-tin plate

Range-taking narrow-tongue single-barrel lugs



Cat. no.	Al-Cu cable range (kcmil)	Bolt size	No. of compressions		Dimensions (in.)				Hex die no.	Color code
			TBM12M	13642, TBM15	A	B	C	D		
60273N	350–500	½"	4	4	6⅞	3⅞	1⅞/32	1⅞/32	99H	Pink
60278N	500–750	½"	–	4	7⅞	3⅞/16	1½	½	115H	Yellow

Diagrams

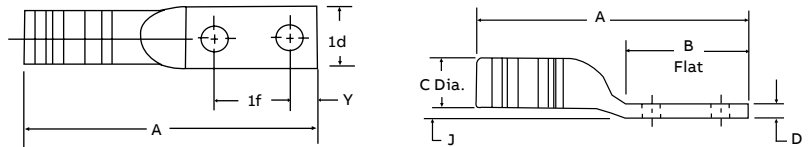

* 90 °C, 600 V to 35 kV applications

All lugs have 1½"-wide tongues. Bolt holes on 1¾" centers.

Tooling – see pages 104-127.

Die selector chart – see pages 128-133.

Connectors for aluminum/copper code conductor

One-hole aluminum compact-size equipment lug



Much smaller than standard aluminum lugs for the same cable size.

- For 90 °C, 600 V applications
- For use with aluminum cables only
- Can be directly substituted for equipment mechanical lugs in most applications
- Only seven dies handle all 14 lug sizes
- Factory-filled with joint compound
- Electro-tin plated
- Supplied with neoprene insulating covers

One-hole aluminum compact-size equipment lug



Cat. no.	Aluminum cable size (AWG or kcmil)	Aluminum range taking* (AWG or kcmil)	Bolt hole (in.)	Dimensions (in.)						
				A	B	C	D	E	F	
61102	#8	–	¼	1.33	0.54	0.50	0.14	0.37	0.25	
61107	#6	–	¼	1.33	0.54	0.50	0.14	0.37	0.25	
61112	#4	–	¼	1.33	0.54	0.50	0.14	0.37	0.25	
61116	#2	–	¼	1.75	0.68	0.55	0.20	0.48	0.25	
61122	#1	–	¼	1.75	0.68	0.55	0.20	0.48	0.25	
61130	1/0	#8–1/0	⅜	2.00	0.83	0.64	0.20	0.57	0.38	
61136	2/0	#1–2/0	⅜	2.00	0.83	0.64	0.20	0.57	0.38	
61142	3/0	–	⅜	2.50	1.08	0.78	0.23	0.70	0.38	
61148	4/0	2/0–4/0	⅜	2.50	1.08	0.78	0.23	0.70	0.38	
61156	250	–	½	2.50	1.23	0.98	0.25	0.85	0.50	
61162	300	#4–300	½	2.50	1.23	0.98	0.25	0.85	0.50	
61165	350	250–350	½	3.25	1.23	1.20	0.41	1.04	0.56	
61171	500	2/0–500	½	3.25	1.23	1.20	0.41	1.04	0.56	
61178	750	500–750	⅝	3.75	1.54	1.49	0.41	1.33	0.81	

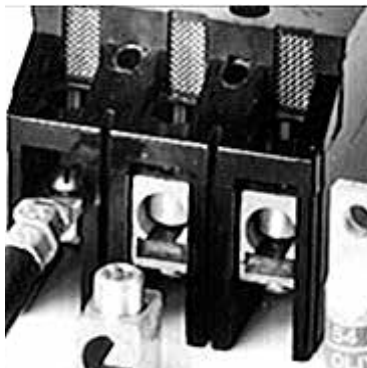

Diagrams

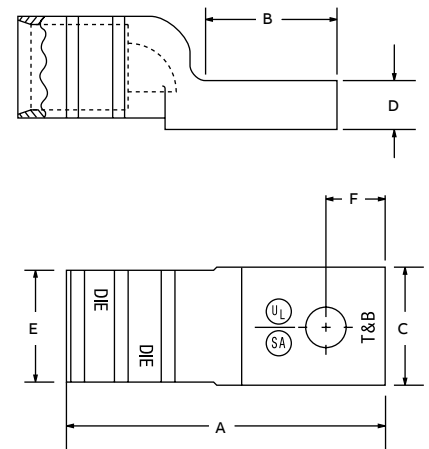

600 V, 90 °C

This lug is reduced in size as compared to an aluminum lug of the same cable size. It can be substituted for the equipment mechanical lugs in most cases.

Factory-filled with joint compound. Electro-tin plated. Cover is neoprene.

* For range-taking capability, use TBM8-750/TBM8-750M1 smart tool.

Tooling – see pages 104-127.

Die selector chart – see pages 128-133.

Connectors for aluminum/copper code conductor

Two-way splice connectors



For aluminum-to-copper, aluminum-to-aluminum or copper-to-copper splicing.

- For 90 °C, 600 V to 35 kV applications
- For aluminum and copper concentric conductors and compact code aluminum strandings
- Permit aluminum conductors to be spliced to copper or aluminum conductors

Material – High-conductivity wrought aluminum

Finish – Electro-tin plate

Two-way splice connectors



Cat. no.	Conductor code (AWG or kcmil)	Dimensions (in.)		Die code	Color code
		A	E		
60500	#10 Str.	1.00	0.27	21	Red
60501	#8 Str.	1.19	0.28	24	Blue
60507	#6 Str.	1.63	0.35	29	Gray
60512	#4 Str.	1.81	0.46	37	Green
60516	#2 Str./#3 Str.	1.81	0.51	42	Pink
60522	#1 Str.	2.38	0.56	45	Gold
60530	1/0	2.38	0.62	50	Tan
60536	2/0	2.50	0.70	54	Olive
60542	3/0	2.81	0.77	60	Ruby
60548	4/0	3.66	0.86	66	White
60554	250	3.91	0.92	71	Red
60560	300	3.97	0.99	76	Blue
60565	350	4.97	1.09	87	Brown
60568	400	4.97	1.18	94	Green
60571	500	4.97	1.28	99	Pink
60574	600	5.22	1.36	106	Black
60576	700	5.44	1.44	112	Purple
60578	750/900 compact	5.69	1.50	115	Yellow
60584	1000	6.69	1.77	140	-

Connectors for aluminum/copper code conductor

Aluminum reducing connectors

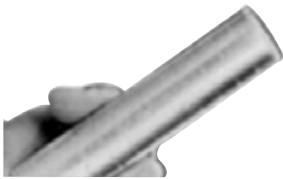

Splice aluminum conductors to copper conductors of equal ampacities.

- For 90 °C, 600 V applications
- Filled with high-temperature oxide-inhibiting compound
- Designed for the right combination of equivalent sizes (Example: 4/0 AWG aluminum to 2/0 AWG copper)
- Selection table gives aluminum/copper equivalents for all sizes

Material – High-conductivity wrought aluminum

Finish – Electro-tin plate

Aluminum reducing connectors

Cat. no.	Cable size (AWG or kcmil)		Dimensions (in.)			Color key
	Aluminum	Copper	A	E	Die code	
60905	#8	#10	$1\frac{3}{16}$	$\frac{9}{32}$	24	Blue
60910	#6	#8	$1\frac{5}{8}$	$1\frac{1}{32}$	29	Gray
60915	#4	#6	$1\frac{13}{16}$	$\frac{7}{16}$	37	Green
60925	#1	#3	$2\frac{3}{8}$	$1\frac{7}{32}$	45	Gold
60930	1/0	#2	$2\frac{3}{8}$	$\frac{5}{8}$	50	Tan
60935	2/0	#1	$2\frac{1}{2}$	$1\frac{1}{16}$	54	Olive
60940	3/0	1/0	$2\frac{13}{16}$	$\frac{3}{4}$	60	Ruby
60945	4/0	2/0	$3\frac{3}{4}$	$\frac{7}{8}$	66H	White
60950	250	3/0	4	$1\frac{5}{16}$	71H	Red
60955	300	4/0	$4\frac{1}{16}$	1	76H	Blue
60960	350	4/0	$5\frac{1}{16}$	$\frac{3}{32}$	87H	Brown
60965	400	250	$5\frac{1}{16}$	$1\frac{7}{32}$	94H	Green
60970	500	350	$5\frac{1}{16}$	$1\frac{5}{16}$	99H	Pink
60975	600	400	$5\frac{5}{16}$	$1\frac{11}{32}$	106H	Black
60980	700	500	$5\frac{9}{16}$	$1\frac{1}{16}$	112H	Purple
60985	750	500	$5\frac{13}{16}$	$1\frac{1}{2}$	115H	Yellow

Diagram

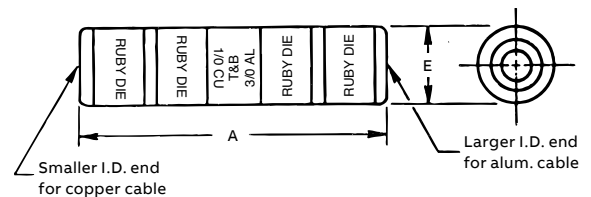

Selection table gives aluminum/copper equivalents for all sizes.
Connectors are filled with a high-temperature oxide-inhibiting compound.
Tooling – see pages 104-127.
Die selector chart – see pages 128-133.

Installing Tools: TBM5(s) #10 AWG → 4/0 AWG
TBM6(s) #10 AWG → 350 kcmil
TBM8(s) #10 AWG → 350 kcmil

Connectors for aluminum/copper code connector

Transformer lug kits



Everything you need to connect to a transformer in one convenient kit.

- For 90 °C, 600 V applications
- For use with aluminum cables only
- Include all necessary range-taking compression or mechanical type lugs and bolting hardware to connect to designated transformers

Transformer lug kits

Transformer KVA sizes	Kit cat. no.	Al cable range* (AWG or kcmil)	Terminal lugs				Kit contents			Std. pkg.	
			Qty.	Nuts	Qty.	Bolts (in.)	Qty.	Washers (in.)	Qty.		
Compression											
15-37½ 1Ø	611CL-SK1	#8-1/O Al	Color-Keyed® compression equipment lugs	8	¼-20	8	¼-20 x 1	8	Flat ¼	8	1
15-45 3Ø		#4-300		4	–	–	–	–	Spring ¼	8	–
50-75 1Ø	611CL-SK2	#4-300 Al	–	12	¼-20	16	¼-20 x 1	8	Flat ¼	16	1
75-112½ 3Ø		–		–	–	–	¼-20 x 2	8	Spring ¼	16	–
100-167 1Ø	611CL-SK3	#4-300 Al	–	3	¼-20	3	¼-20 x ¾	3	Flat ¼	3	–
150-300 3Ø		–		–	–	–	–	–	Spring ¼	3	1
		2/0-500 Al	–	22	¾-16	16	¾-16 x 2	16	Flat ¾	16	–
		–		–	–	–	–	–	Spring ¾	16	–
100-167 1Ø	611CL-SK3-500	#4-300 Al	–	3	¼-20	3	¼-20 x 1	3	Flat ¼	3	–
150-300 3Ø		–		–	–	–	–	–	Spring ¼	3	1
		2/0-500 Al	–	22	¾-16	16	¾-16 x 2	16	Flat ¾	16	–
		–		–	–	–	–	–	Spring ¾	16	–
500 3Ø	611CL-SK4	#500-750 Al	–	29	¾-16	18	¾-16 x 2	18	Flat ¾	18	1
		–		–	–	–	–	–	Spring ¾	18	–
Mechanical											
15-37½ 1Ø	622ML-SK1	#14-2	Ready lugs mechanical lugs**	8	¼-20	8	¼-20 x ¾	8	Flat ¼	8	1
15-45 3Ø		#6-250		4	–	–	–	–	Spring ¼	8	–
50-75 1Ø	622ML-SK2	#6-250	–	12	¼-20	16	¼-20 x ¼	8	Flat ¼	16	1
75-112½ 3Ø		–		–	–	–	¼-20 x 1¾	8	Spring ¼	16	–
100-167 1Ø	622ML-SK3	#6-250	–	3	¼-20	3	¼-20 x ¾	3	Flat ¼	3	–
150-300 3Ø		–		–	–	–	–	–	Spring ¼	3	1
		350-800	–	22	¾-16	16	¾-16 x 2	16	Flat ¾	16	–
		–		–	–	–	–	–	Spring ¾	16	–
500 3Ø	622ML-SK4	350-800	–	29	¾-16	18	¾-16 x 2	18	Flat ¾	18	1
		–		–	–	–	–	–	Spring ¾	18	–

* To ensure proper range-taking compression on Blackburn® equipment lugs, use Smart® tool (Cat. no. TBM8-750/TBM8-750M-1). *

* Largest cable in lug can be applied with standard hex or hand tool.

Tooling – see pages 104-127.

Die selector chart – see pages 128-133.

Connectors for aluminum/copper code conductor

Bi-Pin® bi-metal pin connectors with insulating covers



Converts an aluminum cable into a two-sizes-smaller copper pigtail.

- For 90 °C, 600 V applications
- Upgrades connection by eliminating cold flow and oxidation of aluminum
- Reduces oversized aluminum cable
- Enables termination of aluminum cable into a copper-only lug
- Barrel prefilled with joint compound

Material – Copper wire/aluminum body

Finish – Electro-tin plate

Insulator – Neoprene (600 V dielectric rating)

Bi-Pin bi-metal pin connectors with insulating covers



Cat. no.	Cable size (AWG or kcmil)		Body length after installing (in.)	Die code no.	Color key
	Aluminum	Copper wire size			
61905A	#8	#10	1 ⁷ / ₈	24	Blue
61910A	#6	#8	1 ⁷ / ₈	24	Blue
61915A	#4	#6	1 ⁹ / ₁₆	45	Gold
61920A	#2	#4	1 ⁹ / ₁₆	45	Gold
61925A	#1	#3	1 ⁵ / ₈	50	Orange
61930A	1/0	#2	1 ⁵ / ₈	50	Orange
61935	2/0	#1	1 ⁵ / ₁₆	50	Orange
61940	3/0	1/0	2 ¹ / ₈	60	Ruby
61945	4/0	2/0	2 ¹ / ₈	60	Ruby
61950	250	3/0	2 ³ / ₁₆	66	White
61955	300	4/0	2 ¹ / ₂	71H	Red
61960	350	250	2 ¹ / ₂	71H	Red
61963	400	250	3 ³ / ₄	87H	Brown
61965	500	350	3 ³ / ₄	87H	Brown
61970	600	400	3 ³ / ₄	107H	Orange
61975	700–750	500	3 ³ / ₄	107H	Orange

Diagrams

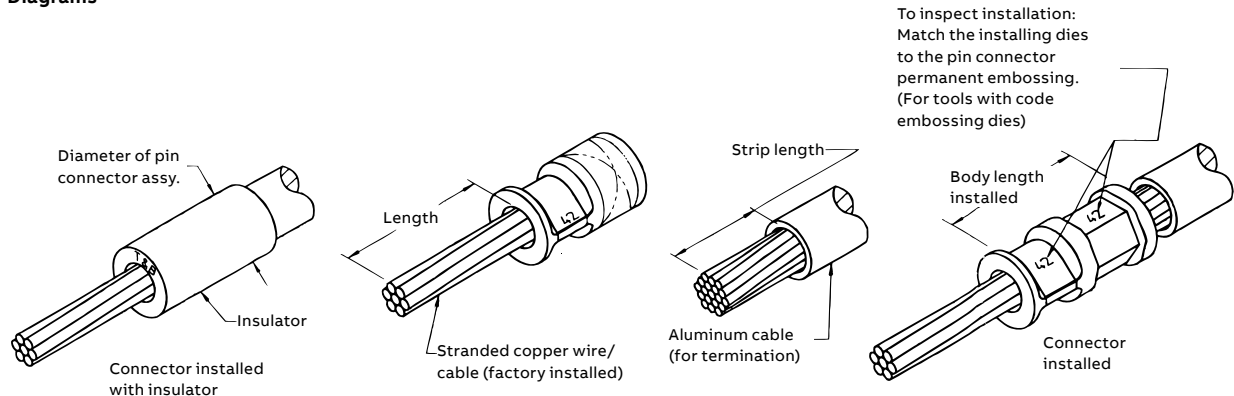

Connectors for aluminum/copper code conductor

90° Flag lugs – 600 V, 90 °C



Material – Aluminum
Finish – Electro-tin plate
Insulation – PVC dip coated

90° Flag lugs — 600 V, 90 °C

Cat. no.	Cu cable size (AWG)	Stud size (in.)	Phase	Dimensions (in.)							Die code
				A	B	C	D	E	F	G	
10A-FT-14NTK	1/0	¼	1	1.38	0.94	0.64	0.19	0.62	0.25	2.50	50
			2	2.13							
			3	2.88							
20A-FT-14NTK	2/0	¼	1	1.93	1.14	0.64	0.22	0.70	0.25	2.50	54
			2	2.93							
			3	3.93							
30A-FT-14NTK	3/0	¼	1	2.11	1.14	0.78	0.22	0.77	0.25	2.75	60
			2	3.11							
			3	4.11							
40A-FT-14NTK	4/0	¼	1	2.04	1.14	0.78	0.25	0.86	0.25	3.13	66
			2	3.04							
			3	4.04							

* Each Cat. no. consists of three connectors, (1) connector per phase. Connectors supplied with Thomas & Betts oxide-inhibitor compound in wire bore.
 Installation tooling: Hand or hydraulic tools.



Cat. no.	Cu cable size (kcmil)	Stud size (in.)	Phase	Dimensions (in.)							Die code
				A	B	C	D	E	F	G	
250A-FT-14NTK	250	¼	1	2.31	1.20	0.98	0.25	0.92	0.31	3.00	71
			2	3.44							
			3	4.57							
350A-FT-12NTK	350	¼	1	2.31	1.45	1.09	0.31	1.09	0.56	3.94	87
			2	3.69							
			3	5.06							
500A-FT-12NTK	500	¼	1	2.56	1.45	1.20	0.38	1.28	0.56	4.19	99
			2	4.06							
			3	5.69							
750A-FT-58NTK	750	¼	1	2.63	1.70	1.49	0.38	1.50	0.81	4.39	115
			2	4.50							
			3	6.25							

Diagrams

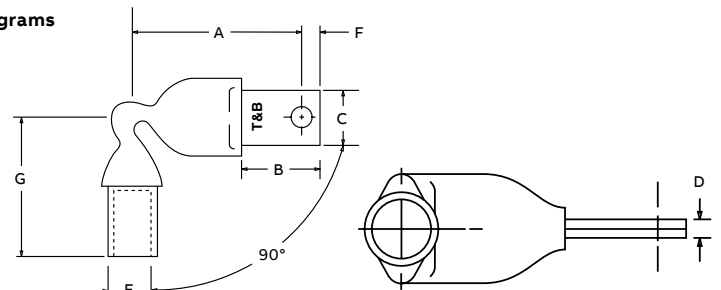

Heavy-duty battery connectors

Tin-plated straight battery connectors



BAC10SUBT



BAC10SPBT

Material – High-conductivity copper

Finish – Electro-tin plate

Installing tools – TBM5-SV, TBM5V, TBM8250, TBM8250S

Tin-plated straight battery connectors

Cat. no.	Bulk cat. no.	SAE cable size (gauge)	Description	I.D. (in.)	O.D. (in.)	Pkg. qty.	Bulk pkg. qty.	Color key
BAC4SUBT	BAC4SUBT-C	4	Straight universal	0.261	0.430	5	100	Gray
BAC2SUBT	BAC2SUBT-C	2	Straight universal	0.340	0.550	5	100	Green
BAC1SUBT	BAC1SUBT-C	1	Straight universal	0.340	0.550	5	100	Pink
BAC10SUBT	BAC10SUBT-C	1/0	Straight universal	0.455	0.625	5	100	Black
BAC20SUBT	BAC20SUBT-C	2/0	Straight universal	0.502	0.676	5	100	Orange
BAC30SUBT	BAC30SUBT-C	3/0	Straight universal	0.530	0.730	5	100	Purple
BAC40SUBT	BAC40SUBT-C	4/0	Straight universal	0.600	0.844	5	100	Yellow
BAC4SPBT	BAC4SPBT-C	4	Straight positive	0.261	0.430	5	100	Gray
BAC4SNBT	BAC4SNBT-C	4	Straight negative	0.261	0.430	5	100	Gray
BAC2SPBT	BAC2SPBT-C	2	Straight positive	0.340	0.550	5	100	Green
BAC2SNBT	BAC2SNBT-C	2	Straight negative	0.340	0.550	5	100	Green
BAC1SPBT	BAC1SPBT-C	1	Straight positive	0.340	0.550	5	100	Pink
BAC1SNBT	BAC1SNBT-C	1	Straight negative	0.340	0.550	5	100	Pink
BAC10SPBT	BAC10SPBT-C	1/0	Straight positive	0.455	0.625	5	100	Black
BAC10SNBT	BAC10SNBT-C	1/0	Straight negative	0.455	0.625	5	100	Black
BAC20SPBT	BAC20SPBT-C	2/0	Straight positive	0.502	0.676	5	100	Orange
BAC20SNBT	BAC20SNBT-C	2/0	Straight negative	0.502	0.676	5	100	Orange
BAC30SPBT	BAC30SPBT-C	3/0	Straight positive	0.530	0.730	5	100	Purple
BAC30SNBT	BAC30SNBT-C	3/0	Straight negative	0.530	0.730	5	100	Purple
BAC40SPBT	BAC40SPBT-C	4/0	Straight positive	0.600	0.844	5	100	Yellow
BAC40SNBT	BAC40SNBT-C	4/0	Straight negative	0.600	0.844	5	100	Yellow

Diagrams

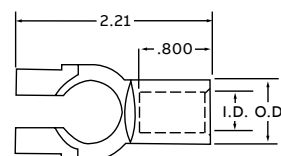
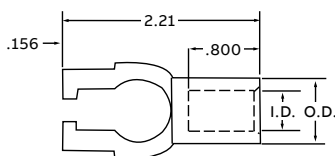

Heavy-duty battery connectors

Tin-plated flag battery connectors



BAC10FNBT

Material – High-conductivity copper

Finish – Electro-tin plate

Installing tools – TBM5-SV, TBM5V,
TBM8250, TBM8250S

Tin-plated flag battery connectors

Cat. no.	Bulk cat. no.	SAE cable size (gauge)	Description	I.D. (in.)	O.D. (in.)	Pkg. qty.	Bulk pkg. qty.	Color key
BAC10FU	BAC10FNBL	1/0	Flag universal	0.455	0.625	5	100	Black
BAC20FU	BAC20FNBL	2/0	Flag universal	0.502	0.676	5	100	Orange
BAC30FU	BAC30FNBL	3/0	Flag universal	0.530	0.730	5	100	Purple
BAC40FU	BAC40FNBL	4/0	Flag universal	0.600	0.844	5	100	Yellow
BAC10FPBT	BAC10FPBT-C	1/0	Flag positive	0.455	0.625	5	100	Black
BAC10FNBT	BAC10FNBT-C	1/0	Flag negative	0.455	0.625	5	100	Black
BAC20FPBT	BAC20FPBT-C	2/0	Flag positive	0.502	0.676	5	100	Orange
BAC20FNBT	BAC20FNBT-C	2/0	Flag negative	0.502	0.676	5	100	Orange
BAC30FPBT	BAC30FPBT-C	3/0	Flag positive	0.530	0.730	5	100	Purple
BAC30FNBT	BAC30FNBT-C	3/0	Flag negative	0.530	0.730	5	100	Purple
BAC40FPBT	BAC40FPBT-C	4/0	Flag positive	0.600	0.844	5	100	Yellow
BAC40FNBT	BAC40FNBT-C	4/0	Flag negative	0.600	0.844	5	100	Yellow

Diagram

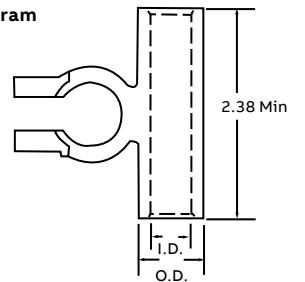

Heavy-duty battery connectors

Tin-plated elbow battery connectors



BAC10ELNBT

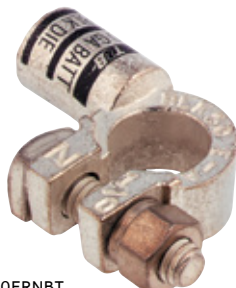

BAC10ERNBT

Material – High-conductivity copper

Finish – Electro-tin plate

Installing tools – TBM5-SV, TBM5V,
TBM8250, TBM8250S

Tin-plated elbow battery connectors

Cat. no.	Bulk cat. no.	SAE cable size (gauge)	Description	I.D. (in.)	O.D. (in.)	Pkg. qty.	Bulk pkg. qty.	Color key
BAC10ERNBT	BAC10ERNBT-C	1/0	Right elbow – Negative	0.455	0.625	5	100	Black
BAC10ERPBT	BAC10ERPBT-C	1/0	Right elbow – Positive	0.455	0.625	5	100	Orange
BAC20ERNBT	BAC20ERNBT-C	2/0	Right elbow – Negative	0.502	0.676	5	100	Orange
BAC20ERPBT	BAC20ERPBT-C	2/0	Right elbow – Positive	0.502	0.676	5	100	Orange
BAC30ERNBT	BAC30ERNBT-C	3/0	Right elbow – Negative	0.530	0.730	5	100	Purple
BAC30ERPBT	BAC30ERPBT-C	3/0	Right elbow – Positive	0.530	0.730	5	100	Purple
BAC40ERNBT	BAC40ERNBT-C	4/0	Right elbow – Negative	0.600	0.844	5	100	Yellow
BAC40ERPBT	BAC40ERPBT-C	4/0	Right elbow – Positive	0.600	0.844	5	100	Yellow
BAC10ELNBT	BAC10ELNBT-C	1/0	Left elbow – Negative	0.455	0.625	5	100	Black
BAC10ELPBT	BAC10ELPBT-C	1/0	Left elbow – Positive	0.455	0.625	5	100	Black
BAC20ELNBT	BAC20ELNBT-C	2/0	Left elbow – Negative	0.502	0.676	5	100	Orange
BAC20ELPBT	BAC20ELPBT-C	2/0	Left elbow – Positive	0.502	0.676	5	100	Orange
BAC30ELNBT	BAC30ELNBT-C	3/0	Left elbow – Negative	0.530	0.730	5	100	Purple
BAC30ELPBT	BAC30ELPBT-C	3/0	Left elbow – Positive	0.530	0.730	5	100	Purple
BAC40ELNBT	BAC40ELNBT-C	4/0	Left elbow – Negative	0.600	0.844	5	100	Yellow
BAC40ELPBT	BAC40ELPBT-C	4/0	Left elbow – Positive	0.600	0.844	5	100	Yellow

Diagram

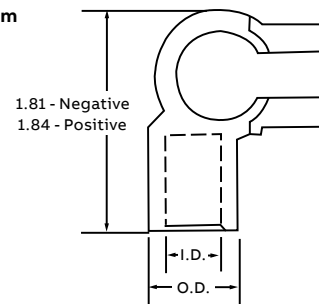

Heavy-duty battery connectors

Tin-plated stackable battery connector



BAC1038

Material – High-conductivity copper

Finish – Electro-tin plate

Installing tools – TBM5-SV or TBM5V

Tin-plated stackable battery connector

Cat. no.	Bulk cat. no.	SAE cable size (gauge)	Dimensions (in.)						Stud size (in.)	Pkg. qty.	Bulk pkg. qty.	Color key
			A ±.040	M ±.020	W ±.020	C ±.020	E ±.010					
BAC438	273-31853-1	4	1.455	1.143	0.615	0.750	0.365	3/8	10	100	Gray	
BAC238	273-31853-2	2	1.775	1.400	0.675	0.850	0.467	3/8	10	100	Green	
BAC138	273-31853-3	1	1.875	1.500	0.750	0.950	0.521	3/8	10	100	Pink	
BAC1038	273-31853-4	1/0	1.925	1.550	0.825	1.000	0.571	3/8	10	100	Black	
BAC2038	273-31853-5	2/0	2.110	1.645	0.930	1.100	0.632	3/8	10	100	Orange	
BAC3038	273-31853-6	3/0	2.025	1.650	1.025	1.100	0.701	3/8	10	100	Purple	
BAC4038	273-31853-7	4/0	2.275	1.900	1.125	1.350	0.766	3/8	10	100	Yellow	

Diagram

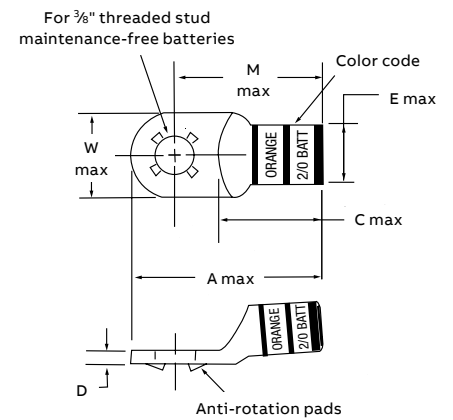

Heavy-duty battery connectors

Blackburn® starter lugs



BAL414

Material – High-conductivity copper

Finish – Electro-tin plate

Installing tools – TBM5-SV or TBM5V

Blackburn starter lugs

Cat. no.	Bulk cat. no.	SAE cable size (gauge)	Stud size (in.)	Dimensions (in.)				Pkg. qty.	Bulk pkg. qty.	Color key
				A ±04	B ±02	C ±02	D ±02			
BAL414	273-31852-1	4	¼	1.40	0.52	0.40	1.15	10	100	Gray
BAL4516	273-31852-2	4	⅝ ₁₆	1.45	0.61	0.36	1.14	10	100	Gray
BAL438	273-31852-3	4	⅜	1.45	0.61	0.36	1.14	10	100	Gray
BAL2516	–	2	⅝ ₁₆	1.59	0.69	0.40	1.25	10	–	Green
BAL238	273-31852-4	2	⅜	1.78	0.67	0.55	1.40	10	100	Green
BAL212	273-31852-5	2	½	1.77	0.76	0.54	1.40	10	100	Green
BAL1516	–	1	⅝ ₁₆	1.83	0.76	0.49	1.50	10	–	Pink
BAL138	273-31852-6	1	⅜	1.85	0.75	0.55	1.50	10	100	Pink
BAL112	273-31852-7	1	½	2.20	0.75	0.75	1.70	10	100	Pink
BAL10516	–	1/0	⅝ ₁₆	1.92	0.83	0.50	1.50	10	–	Black
BAL1038	273-31852-8	1/0	⅜	1.93	0.83	0.55	1.55	10	100	Black
BAL1012	273-31852-9	1/0	½	1.97	0.88	0.53	1.53	10	100	Black
BAL20516	–	2/0	⅝ ₁₆	2.06	0.93	0.50	1.60	10	–	Orange
BAL2038	273-31852-10	2/0	⅜	2.11	0.93	0.55	1.65	10	100	Orange
BAL2012	273-31852-11	2/0	½	2.11	0.93	0.55	1.65	10	100	Orange
BAL30516	–	3/0	⅝ ₁₆	2.16	1.03	0.55	1.65	10	–	Purple
BAL3038	273-31852-12	3/0	⅜	2.03	1.03	0.55	1.65	10	100	Purple
BAL3012	273-31852-13	3/0	½	2.35	1.03	0.75	1.85	10	100	Purple
BAL40516	–	4/0	⅝ ₁₆	2.40	1.13	0.59	1.84	10	–	Yellow
BAL4038	273-31852-14	4/0	⅜	2.28	1.12	0.55	1.90	10	100	Yellow
BAL4012	273-31852-15	4/0	½	2.60	1.12	0.75	2.10	10	100	Yellow

Diagram

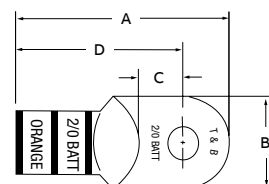

Heavy-duty battery connectors

Splices



BAS4

Material – High-conductivity copper

Finish – Electro-tin plate

Installing tools – TBM5-SV or TBM5V

Splices (two-way connectors)

Cat. no.	Bulk cat. no.	SAE cable size (gauge)	Pkg. qty.	Bulk pkg. qty.	Color key
BAS4	273-31852-16	4	10	100	Gray
BAS2	273-31852-17	2	10	100	Green
BAS1	273-31852-18	1	10	100	Pink
BAS10	273-31852-19	1/0	10	100	Black
BAS20	273-31852-20	2/0	10	100	Orange
BAS30	273-31852-21	3/0	10	100	Purple
BAS40	273-31852-22	4/0	10	100	Yellow



BASY30

Material – High-conductivity copper

Finish – Electro-tin plate

Installing tools – TBM5-SV or TBM5V

Insulating cover – AC5X3

“Y” splices

Cat. no.	Strip cable size	SAE cable size (gauge)	Length (in.)	Color key
BASY20	2/0–(2) #2	2/0	¾	Orange
BASY30	3/0–(2) #1	3/0	¾	Purple
BASY40	4/0–(2) 1/0	4/0	7/8	Yellow

Heavy-duty battery connectors

Blackburn® battery/starter cables



BC10-25R



BC10-25



Abrasion resistant and engineered for optimum performance at both high and low temperatures.

- Fine flexible copper rope stranding PVC jacket conforms to SAE J1127 specifications
- Layer of paper separates insulation from copper, providing easy stripping with no stranding damage
- Temperature rated for 80 °C
- Flexibility ideal for tight spaces and cold environments
- Blackburn Color-Keyed® system markings for fast and accurate identification
- Marked in 1-ft. increments for easy measurement
- Available in red or black jacket color

Material – High-conductivity copper

Finish – Electro-tin plate

Installing tools – TBM5-SV or TBM5V

—
Blackburn battery/starter cables

Cat. no.	SAE cable size (gauge)	Cable length (ft.)	Cable color
BC4-100	4	100	Black
BC2-100	2	100	
BC1-100	1	100	
BC10-100	1/0	100	
BC20-100	2/0	100	
BC30-100	3/0	100	
BC40-100	4/0	100	
BC4-1000	4	1000	
BC2-500	2	500	
BC1-500	1	500	
BC10-500	1/0	500	
BC20-500	2/0	500	
BC30-500	3/0	500	
BC40-500	4/0	500	
BC4-1000R	4	1000	Red
BC2-500R	2	500	
BC1-500R	1	500	
BC10-500R	1/0	500	
BC20-500R	2/0	500	
BC30-500R	3/0	500	
BC40-500R	4/0	500	

Cat. no.	SAE cable size (gauge)	Cable length (ft.)	Cable color
BC4-25	4	25	Black
BC2-25	2	25	
BC1-25	1	25	
BC10-25	1/0	25	
BC20-25	2/0	25	
BC30-25	3/0	25	
BC40-25	4/0	25	
BC4-25R	4	25	
BC2-25R	2	25	
BC1-25R	1	25	
BC10-25R	1/0	25	
BC20-25R	2/0	25	
BC30-25R	3/0	25	
BC40-25R	4/0	25	

—
Heavy-duty battery cable



Specially designed for demanding industrial and OEM requirements.

- 105 °C temperature rated and UL® recognized
- Heavier PVC jacket conforms to SAE J1127 specifications
- Blackburn® Color-Keyed® system markings for fast and accurate identification

- Marked in 1-ft. increments for easy measurement
- Layer of paper separates insulation from copper for easy stripping with no strand damage
- 600 V rated available in bulk only
- Application specific – Call to order

Metric connectors for copper conductor

One-hole metric lugs

Blackburn® metric lugs are manufactured from electrolytic copper tube. The dimensions of the tube are designed to obtain the most efficient electrical conductivity and mechanical strength, resisting vibration and pull out.

Blackburn metric lugs are annealed to guarantee optimum ductility, which is a necessity for compression connectors having to withstand severe deformation arising when compressed or bending of the tongue that may happen during installation.

Connectors have to perform adequately with vibration loads, and annealing is necessary to avoid material failure between the barrel and the tongue.

The presence of an inspection hole facilitates full insertion of the conductor, and the barrel length is designed to allow easy and accurate positioning of the dies during the crimping operation.

Lugs are electrolytically tin-plated to eliminate oxidation of the copper material. Blackburn metric lugs complement our connector family and meet a growing need for customer's connector requirements. Details of the appropriate crimping tools and dies are included. Our Technical Services group is always available to provide any technical advice required. Please contact them if sizes are needed additional to those shown in this catalog.



Cat. no.	Cond. size sq. mm		Stud mm	Dimensions (mm)						Std. pkg.	6 Ton TBM62BSCR (crimps)	14 Ton BPLT14BSCRI (crimps)	26 Ton TBM26MCC (crimps)	60 Ton TBM60MCC (crimps)
	Low stranded	flexible		Ø	Øi	B	M	N	L					
MCC6M4	-	4÷6	4	3,6	8,0	5,0	4,0	21,5	4,3	100	MCD6-6 (1)	-	-	-
MCC6M5			5	3,6	9,0	6,5	6,0	25,0	5,3	100				
MCC6M6			6	3,6	11,0	7,0	6,0	25,5	6,4	100				
MCC10M4	-	10	4	4,6	10,0	5,0	4,0	22,5	4,3	100	MCD10-6 (1)	MCD10-14 (1)	-	-
MCC10M5*			5	4,6	10,0	6,5	6,0	26,0	5,3	100				
MCC10M6*			6	4,6	11,0	7,0	6,0	26,5	6,4	100				
MCC10M8*			8	4,6	15,0	9,0	8,0	30,5	8,4	100				
MCC10M10*			10	4,6	18,0	11,0	10,0	34,5	10,5	100				
MCC16M4*	-	16	4	5,8	11,5	5,0	4,0	25,5	4,3	100	MCD16-6 (1)	MCD16-14 (1)	-	-
MCC16M5*			5	5,8	11,5	6,5	6,0	29,0	5,3	100				
MCC16M6*			6	5,8	11,5	7,0	6,0	29,5	6,4	100				
MCC16M8*			8	5,8	15,0	9,0	8,0	33,5	8,4	100				
MCC16M10*			10	5,8	18,0	11,0	10,0	37,5	10,5	100				
MCC25M5*	-	25	5	7,0	14,0	6,5	6,0	31,5	5,3	100	MCD25-6 (1)	MCD25-14 (1)	-	-
MCC25M6*			6	7,0	14,0	7,0	6,0	32,0	6,4	100				
MCC25M8*			8	7,0	15,0	9,0	8,0	36,0	8,4	100				
MCC25M10*			10	7,0	18,0	11,0	10,0	40,0	10,5	100				
MCC35M5*	35	25	5	8,9	17,0	6,5	6,0	34,0	5,3	100	MCD35-6 (1)	MCD35-14 (1)	-	-
MCC35M6*		35	6	8,9	17,0	7,0	6,0	34,5	6,4	100				
MCC35M8*			8	8,9	17,0	9,0	8,0	38,5	8,4	100				
MCC35M10*			10	8,9	19,0	11,0	10,0	42,5	10,5	100				
MCC35M12*			12	8,9	21,0	14,0	12,0	47,5	13,2	50				
MCC50M8*	50	35	8	10,0	19,0	9,0	8,0	42,5	8,4	50	MCD50-6 (2)	MCD50-14 (1)	-	-
MCC50M10*		50	10	10,0	20,0	11,0	10,0	46,5	10,5	50				
MCC50M12*			12	10,0	21,0	14,0	12,0	51,5	13,2	50				
MCC70M6*	70	50	6	11,3	21,0	8,0	7,0	44,0	6,4	50	MCD70-6 (2)	MCD70-14 (1)	-	-
MCC70M8*		70	8	11,3	21,0	9,0	8,0	46,0	8,4	50				
MCC70M10*			10	11,3	21,0	11,0	10,0	50,0	10,5	50				
MCC70M12*			12	11,3	22,0	14,0	12,0	55,0	13,2	50				
MCC70M16*			16	11,3	26,0	18,0	16,0	63,0	17,0	50				
MCC95M8*	95	70	8	13,5	25,0	9,0	8,0	52,5	8,4	25	MCD95-6 (2)	MCD95-14 (1)	-	-
MCC95M10*		95	10	13,5	25,0	11,0	10,0	56,5	10,5	25				
MCC95M12*			12	13,5	25,0	14,0	12,0	61,5	13,2	25				

UL Listed. Note: See metric compression tools on p. 127.

Metric connectors for copper conductor



Cat. no.	Cond. size sq. mm		Ø Stud mm	Dimensions (mm)						Std. pkg.	6 Ton TBM62BSCR (crimps)	14 Ton BPLT14BSCRI (crimps)	26 Ton TBM26MCC (crimps)	60 Ton TBM60MCC (crimps)
	Low stranded	flexible		Øi	B	M	N	L	D					
MCC120M6	120	95	8	-	-	-	-	-	6.4	25	MCD120-6	MCD120-14	-	-
MCC120M8*		120	8	15,2	28,5	9,0	8,0	54,0	8.4	25	(2)	(1)		
MCC120M10*			10	15,2	28,5	11,0	10,0	58,0	10.5	25				
MCC120M12*			12	15,2	28,5	14,0	12,0	63,0	13.2	25				
MCC120M16*			16	15,2	28,5	18,0	16,0	71,0	17.0	25				
MCC150M12*	150	120	12	16,7	31,5	16,0	14,0	75,0	13.2	25	MCD150-6	MCD150-14	-	-
MCC150M16*		150	16	16,7	31,5	19,0	17,0	81,0	17.0	25	(3)	(1)		
MCC185M10*	185	150	10	19,2	35,5	13,0	11,0	76,0	10.5	25	MCD185-6	MCD185-14	-	-
MCC185M12*		185	12	19,2	35,5	16,0	14,0	82,0	13.2	25	(3)	(1)		
MCC185M16*			16	19,2	35,5	19,0	17,0	88,0	17.0	15				
MCC240M10*	240	185	10	21,1	39,0	13,0	11,0	82,0	10.5	15	MCD240-6	MCD240-14	-	-
MCC240M12*		240	12	21,1	39,0	16,0	14,0	88,0	13.2	15	(3)	(2)		
MCC240M16*			16	21,1	39,0	19,0	17,0	94,0	17.0	15				
MCC300M10*	300	240	10	23,7	44,0	20,0	11,0	96,0	10.5	10	-	MCD300-14	-	-
MCC300M12*			12	23,7	44,0	20,0	14,0	99,0	13.2	10		(3)		
MCC300M16*			16	23,7	44,0	22,0	19,0	10,0	17.0	10				
MCC400M10	400	300	12	27,0	51,0	22,0	19,0	113,0	13.2	5	-	MCD400-14	MCD400-26	MCD400-60
MCC400M12			12	27,0	51,0	22,0	19,0	113,0	13.2	5		(3)	(2)	(2)
MCC400M16			16	27,0	51,0	22,0	19,0	113,0	17.0	5				
MCC500M10	500	400	16	-	-	-	-	-	13,2	5	-	-	MCD500-26	MCD500-60
MCC500M12			16	-	-	-	-	-	17,0	5			(2)	(2)
MCC500M16			16	30,3	56,5	22,0	19,0	117,0	17,0	5				
MCC630M16	630	500	16	33,4	61,6	22,0	19,0	128,0	17,0	6	-	-	MCD630-26	MCD630-60
MCC630M20			20	33,4	61,6	24,0	23,0	134,0	21,0	6			(2)	(2)
MCC800M16	800	630	16	38,0	72,0	24,0	19,0	141,0	17,0	3	-	-	-	MCD800-60
MCC800M20			20	38,0	72,0	24,0	23,0	145,0	21,0	3				(2)
MCC1000M16	1000	800	16	44,0	80,0	24,0	19,0	158,0	17,0	2	-	-	-	MCD1000-60
MCC1000M20			20	44,0	80,0	24,0	23,0	162,0	21,0	2				(2)

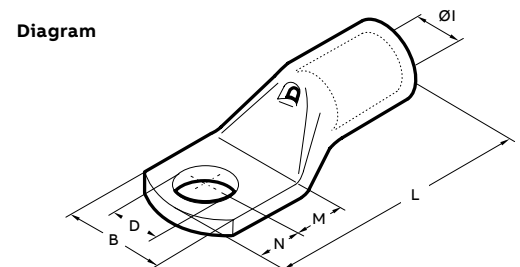

UL Listed. Note: See metric compression tools on p. 127.

Metric connectors for copper conductor

Narrow-tongue metric lugs



Blackburn® narrow-tongue metric lugs feature a contained tongue width. Our lugs have been specifically developed for applications with L.V. circuit breakers with reduced space requirements. The tongue width allows a quicker and easier installation. Blackburn narrow-tongue metric lugs are manufactured from electrolytic copper tube. The specific design of the barrel and dimensions create the best combination

of mechanical strength and electrical conductivity. Blackburn narrow-tongue metric lugs are annealed to guarantee optimum ductility and are electrolytically tin-plated to avoid oxidation. The barrel is provided with an internal chamfer for easy insertion of the conductor. The length allows easy positioning of the dies for proper crimping.

Narrow-tongue metric lugs

Cat. no.	Cond. size flexible sq. mm	Ø Stud mm	Dimensions (mm)							Std. pkg.	6 Ton TBM62BSCR (crimps)	14 Ton BPLT14BSERI (crimps)
			Øi	B	M	N	L	D				
MCCNT10M5	10	5	4,6	9,0	6,5	6,0	26,0	5,3	100	MCD10-6 (1)	MCD10-14 (1)	
MCCNT16M5	16	5	5,8	9,0	6,5	6,0	29,0	5,3	100	MCD16-6 (1)	MCD16-14 (1)	
MCCNT25M5	25	5	7,0	9,0	6,5	6,0	31,5	5,3	100	MCD25-6 (1)	MCD25-14 (1)	
MCCNT35M6	35	6	8,9	11,5	8,0	7,0	36,5	6,4	100	MCD36-6 (1)	MCD35-14 (1)	
MCCNT50M6	50	6	10,0	11,5	8,0	7,0	40,5	6,4	50	MCD50-6 (2)	MCD50-14 (1)	
MCCNT70M6	70	6	11,3	11,5	8,0	7,0	44,0	6,4	50	MCD70-6 (2)	MCD70-14 (1)	
MCCNT95M8	95	8	13,5	15,5	9,0	8,0	52,5	8,	25	MCD95-6 (2)	MCD95-14 (1)	
MCCNT120M8	120	8	15,2	19,0	14,0	9,0	60,0	8,4	25	MCD120-6 (2)	MCD120-14 (1)	
MCCNT120M10		10	15,2	19,0	14,0	9,0	60,0	10,5	25	MCD120-6 (2)	MCD120-14 (1)	
MCCNT150M8	150	8	16,7	19,0	18,0	9,0	70,0	8,4	25	MCD150-6 (3)	MCD150-14 (1)	
MCCNT150M10		10	16,7	19,0	18,0	9,0	70,0	10,5	25	MCD150-6 (3)	MCD150-14 (1)	
MCCNT185M10	185	10	19,2	24,5	18,0	9,0	77,0	10,5	25	MCD185-6 (3)	MCD185-14 (1)	
MCCNT240M10		10	21,1	31,0	13,0	9,0	80,0	10,5	15	MCD240-6 (3)	MCD240-14 (2)	
MCCNT240M12	240	12	21,1	31,0	16,0	12,0	86,0	13,2	15	MCD240-6 (3)	MCD240-14 (2)	
MCCNT240M16		16	21,1	31,0	19,0	17,0	94,0	17,0	15	MCD240-6 (3)	MCD240-14 (2)	
MCCNT300M12	300	12	23,7	31,0	16,0	12,0	95,0	13,2	10	NA	MCD300-14 (3)	

Diagram

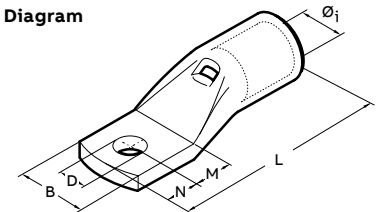

UL Listed. Note: See metric compression tools on p. 127.

Metric connectors for copper conductor

Two-way metric splice connectors



- Blackburn® metric splice connectors are designed for joining low voltage conductors.
- Made of electrolytic copper tube having similar dimensions to the Blackburn metric lugs, these connectors are also annealed and electrolytically tin-plated.
- They feature an internal chamfer at both ends. For easy insertion of the conductor, a center stop is provided to ensure correct positioning.

Two-way metric splice connectors

Cat. no.	Cond. size sq. mm		Dimensions (mm)		Std. pkg.	6 Ton TBM62BSCR (crimps)	14 Ton BPLT14BSERI (crimps)	26 Ton TBM26MCC (crimps)	60 Ton TBM60MCC (crimps)
	Low stranded	flexible	Øi	L					
MCST1	0.25÷1.5	0.25÷1.5	1,8	15	100	-	-	-	-
MCST2	1.5÷2.5	1.5÷2.5	2,4	15	100	-	-	-	-
MCST6	4÷6	4÷6	3,6	22	100	MCD6-6 (1 + 1)	-	-	-
MCST10	10	10	4,6	25	100	MCD10-6 (1 + 1)	MCD10-14 (1 + 1)	-	-
MCST16	16	16	5,8	27	100	MCD16-6 (1 + 1)	MCD16-14 (1 + 1)	-	-
MCST25	25	25	7,0	29	100	MCD25-6 (1 + 1)	MCD25-14 (1 + 1)	-	-
MCST35	35	25÷35	8,9	33	100	MCD35-6 (1 + 1)	MCD35-14 (1 + 1)	-	-
MCST50	50	35÷50	10,0	37	50	MCD50-6 (2 + 2)	MCD50-14 (1 + 1)	-	-
MCST70	70	50÷70	11,3	39	50	MCD70-6 (2 + 2)	MCD70-14 (1 + 1)	-	-
MCST95	95	70÷95	13,5	43	25	MCD95-6 (2 + 2)	MCD95-14 (1 + 1)	-	-
MCST120	120	95÷120	15,2	47	25	MCD120-6 (2 + 2)	MCD120-14 (1 + 1)	-	-
MCST150	150	120÷150	16,7	58	25	MCD150-6 (3 + 3)	MCD150-14 (1 + 1)	-	-
MCST185	185	150÷185	19,2	64	25	MCD185-6 (3 + 3)	MCD185-14 (1 + 1)	-	-
MCST240	240	185÷240	21,1	75	15	MCD240-6 (3 + 3)	MCD240-14 (2 + 2)	-	-
MCST300	300	240	23,7	90	10	-	MCD300-14 (3 + 3)	-	-
MCST400	400	300	27,0	94	5	-	MCD400-14 (3 + 3)	MCD400-26 (2 + 2)	MCD400-60 (2 + 2)
MCST500	500	400	30,3	98	6	-	-	MCD500-26 (2 + 2)	MCD500-60 (2 + 2)
MCST630	600÷630	500	33,4	105	6	-	-	MCD630-26 (2 + 2)	MCD630-60 (2 + 2)
MCST800	800	600	38,0	112	3	-	-	-	MCD800-60 (2 + 2)
MCST1000	1,000	800	44,0	120	3	-	-	-	MCD1000-60 (2 + 2)

Diagram

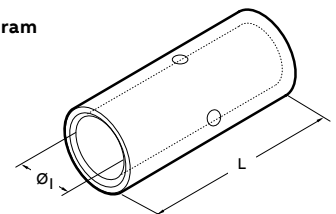

UL Listed. Note: See metric compression tools on p. 127.

Tools and dies

Blackburn® JB12B 12-ton manual hydraulic crimp tool



- Self-contained hydraulic crimping tool for copper, aluminum and ASCR connectors
- Two-stage, rapid-ram advance mechanism for fast installation
- 180° head rotation
- Accepts all U-type dies used for Alcoa®, Burndy®, Thomas & Betts® and Blackburn tools of equivalent tonnage

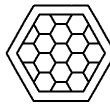

Creates hex-style crimp

Specifications

- Installing range:
 - Up to 750 kcmil copper lugs & splices
 - Up to 650 kcmil aluminum lugs & splices
 - CHT814-10 to CHT2502-6 copper H-taps
 - 63105 to 63148 aluminum H-taps
 - 54755 to 54770 C-taps
- Output force: 12 tons
- Dimensions (L x W x H): 22¾" x 2½" x 4⅞"
- Weight without dies: 13 lbs.

Blackburn JB12B 12-ton manual hydraulic crimp tool

Cat. no.	Description	Pkg. qty.
JB12B	12-ton manual hydraulic crimp tool with carrying case	1



Integral self-gauging system in tool head ensures proper adjustment before each crimp.

- OD58 tool includes ⅝" fixed die in nose and can also accept other standard insert dies, such as O, D, 840, etc.
- ODF and ODB tools feature fixed O and D dies for versatility
- ODB tools also accept other standard MD6 insert dies

- Optional fiberglass handles provides better balance, resulting in easier handling and positioning
- Optional lever action (indicated by L72 suffix) has been optimized and tested to require minimum force to crimp

Blackburn OD mechanical compression tools

Cat. no.	Description	Handle length (in.)	Weight (lb.)
OD58	Fixed ⅝" die, straight wooden handles	21	6.5
OD581	Fixed ⅝" die, fiberglass handles	21	6.0
OD583	Fixed ⅝" die, curved wooden handles	21	6.5
ODF	Fixed o and d dies, straight wooden handles	21	6.5
ODF1	Fixed o and d dies, fiberglass handles	21	6.0
ODF3	Fixed o and d dies, curved wooden handles	21	6.5
ODB	Fixed o and d dies, straight wooden handles	21	6.5
ODB1	Fixed o and d dies, fiberglass handles	21	6.0
ODB3	Fixed o and d dies, curved wooden handles	21	6.5
OD58L72	Fixed ⅝" die, hotstick handles 1.5" X 72"	72	10.5
ODBL72	Fixed o and d dies, hotstick handles 1.5" X 72"	72	10.5
ODH1	Insulating head covers	-	0.40

Tools and dies

Type OD and U-type

Type OD tool dies

Cat. no.	Description or color code
OJB	O
DBL	D
BY39	510 Hex (non-bow)
BY41	635 Hex (non-bow)
BY43	747 Hex (non-bow)
BY45	T
BY47	K
BY49	B
BY51	J
BY53	P
BY13	$\frac{3}{16}$
BY15*	$\frac{7}{32}$ (EEI-1 index 236)
BY17	$\frac{1}{4}$
BY19	$\frac{5}{16}$ (index 161.242)
BY21	$\frac{3}{8}$
BY23	$\frac{1}{2}$ (index 163)
BY25	$\frac{9}{16}$
BY27	$\frac{11}{16}$
BY29	$\frac{19}{32}$
BY31	$\frac{5}{8}$ (index 165)
BY33	737
BY35	781
BY37	840 (EEI 11A)
BY55	Wire cutter (2/0 max.)
BY63	Orange (Nicopress)
BY65	Plum
BY15C*	$\frac{7}{32}$ Red
BY17C*	$\frac{1}{4}$ Blue
BY19C*	$\frac{5}{16}$ Gray
BY21C*	$\frac{3}{8}$ Brown
BY23C*	$\frac{1}{2}$ Pink
BY24C*	$\frac{1}{2}$ -1 Gold
BY25C*	$\frac{9}{16}$ Tan/Orange
BY27C*	$\frac{11}{16}$ Yellow
BY31C*	$\frac{5}{16}$ -1 Olive/Purple
BY32C*	Ruby
BY35C*	781 White
BY37C*	840 Red
BY28C*	$\frac{17}{32}$ Black
BY53C*	P Green
ODH1	Insulating head cover

*Can also be used with OD58 tool.

U-type dies

Cat. no.	Description or color code
B58CS	$\frac{5}{8}$ Die set
HO	O Die set
HD	D Die set
HN	N Die set
HU	U Die set
HBKC	BKC
HBKT	BKT
B24EA	EEI 8A
B30EA	EEI 9A
B39EA	EEI 10A
B49EA	EEI 11A (840)
B61EA	EEI 12A
B80EA	EEI 13A
B20AH	EEI 14A
B71AH	-
B72AH	-
B73AH	-
B74AH	-
B75AH	-
B76AH	-
B76SH	-
B06CHI	Pink/Gold
B08CHI	Tan/Orange
B09CHI	Olive/Purple
B11CH	Red/Blue
B10SH	-
B05CH	Green
B26CH	Ruby/Yellow
B71CH	Red
B72CH	Black
B73CH	Blue
B74CH	Gray
B75CH	Brown
B76CH	Pink
B10CHI	White
B12CHI	Brown

Tools and dies

6.2-ton battery-powered dieless crimping tool and 6.2-ton battery-powered flip-top dieless crimping tool



Tested up to 75 kV, this tool enables you to crimp any connector manufactured to the ANSI C199.4 specification – Up to 500 kcmil.

- Compresses Homac®/Anderson-style lugs with 6.2 tons of force, eliminating the need for dies
- Audible bypass lets you know when predetermined pressure is achieved
- Advance and retract buttons on pistol-grip handle enable one-hand operation, freeing the other hand to maneuver the cable
- Weather-resistant housing, built to last in rugged, outdoor conditions

6.2-ton battery-powered dieless crimping tool — 0.9" jaw opening

Cat. no.	Comp. force	Connector range copper and aluminum lugs and splices (AWG or kcmil)	Dimensions (in.)	Weight (lbs.)	Warranty
HMC-5630	6.2 Tons	#10–500	13H x 2.5W x 14L	11.5 with battery	5 Years

Note: For range-taking connectors, the cable must be the maximum size specified for the connector.



Tested up to 75 kV, this tool crimps any connector manufactured to the ANSI C199.4 specification – From #6 AWG to 750 kcmil.

- Compresses Homac®/Anderson-style lugs with 6.2 tons of force, eliminating the need for dies
- One stationary and three movable indenting nibs close at 90° angles to each other so that the connector is squeezed equally at four strategic points
- External bypass cartridge enables faster pressure adjustment and repair times
- Audible bypass lets you know when predetermined pressure is achieved
- Weather-resistant housing, built to last in rugged, outdoor conditions

6.2-ton battery-powered flip-top dieless crimping tool – 1.5" jaw opening

Cat. no.	Comp. force	Connector range copper and aluminum lugs and splices (AWG or kcmil)	Dimensions (in.)	Weight (lbs.)	Warranty
HMC-5750	6.2 Tons	#6–750	13H x 2.5W x 15.5L	12 with battery	5 Years

Note: For range-taking connectors, the cable must be the maximum size specified for the connector.

Tools and dies

UT 3 M installation tool, UT 3 installation tool and upper dies and utility cable slicers



UT 3 M installation tool

Nothing to lose – A built-in 5/8" die is precision-cast and installs compression connectors from #8 to 4/0.

- Fast action – one stroke of the tool develops full compression
- SHURE-SQUEEZER™ design ensures proper compression before jaws release
- Weighs only 2.2 lbs.

Cat. no.	Description
UT 3 M	Installs compression connectors from #8 to 4/0 AWG



UT 3 installation tool and upper dies

Removable, reversible die installs 1/2" and 5/8" compression connectors.

- Also accommodates UT 3-4 G GOLD DIE, a 1/2" and 5/8" gold upper die for ACSR and UT 3-4 R RED DIE, a 1/2" and 5/8" red upper die for compressed and compact stranded wire
- Fast action – one stroke of the tool develops full compression
- SHURE-SQUEEZER™ design ensures proper compression before jaws release
- Weighs only 2.2 lbs.

Cat. no.	Description
Installation tool	
UT 3	Installs compression connectors on ACSR, stranded, compressed and compact stranded
Upper dies	
UT 3-4 G GOLD DIE	1/2" and 5/8" gold upper die for ACSR and stranded
UT 3-4 R RED DIE	1/2" and 5/8" red upper die for compressed and compact stranded



Utility cable slicers

Drop-forged cutting blades and fiberglass handles designed for easy field replacement.

- Rugged fiberglass handles provide many years of dependable service
- Drop-forged cutting blade's slicing action provides flush, burr-free conductor ends.
- Well-designed handle stops prevent "knuckle busting" during use

Cat. no.	Description	Maximum range (kcmil)	Max. OD inc. insulation (in.)	Overall Length (in.)
UT 4 C	Cable slicer – Small	600 Al–350 Cu	15/16	21
UT 6 C	Cable slicer – Large	1000 Al–500 Cu	2	31 1/2

Note: For use on copper and aluminum cable only. Not for use on steel or ACSR cable.
 For insulating covers for the area where the blades and handles are joined, please consult your Thomas & Betts representative.

Tools and dies

Allen wrench and TBM45S Comfort Crimp® tool



The compact, dependable tool for turning a screw.

- PVC-dipped handle gives you a steady grip while turning
- Available for $\frac{5}{16}$ " and $\frac{3}{8}$ " hex screws to match the most popular screw sizes

Allen wrench

Cat. no.	Hex size (in.)
WA 516	$\frac{5}{16}$
WA 38	$\frac{3}{8}$



Creates diamond-style crimp

- Requires the lowest handle force of any tool in its class – Up to 75% less than competing tools
- Wide installing range of #8–#2 AWG copper and #10–#6 AWG aluminum lugs and splices
- Also installs up to green color-coded C-taps and MD2 Series motor lead disconnects
- Shure-Stake® mechanism ensures a complete crimp cycle before release for a proper crimp every time
- Color-coded die wheel for easy matching with Blackburn® lugs and splices featuring the Color-Keyed® system
- CrimpAssist® foot provides stability when work surface leverage is needed to crimp larger connectors
- UL® Listed for use with Blackburn compression connectors featuring the Color-Keyed system

TBM45S Comfort Crimp tool

Cat. no.	Description	Pkg. qty.
TBM45S	Crimp tool with Shure-Stake mechanism for #8–#2 AWG copper and #10–#6 AWG aluminum lugs and splices	1

Tools and dies

TBM4S and TBM5S

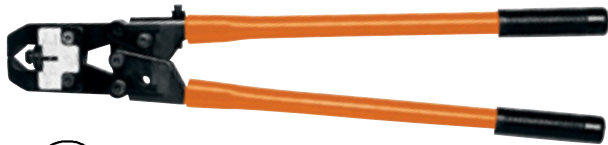

Creates indent-style crimp

- Wide range of #8 AWG to 250 kcmil for copper lugs and #8 to 4/0 AWG for aluminum lugs
- Adjustable indenter eliminates the need to buy and maintain numerous individual dies
- Shure-Stake® mechanism ensures a properly completed crimp each time
- Easily adjusted by turning knurled adjusting wheel and aligning pointer with proper terminal size
- Dieless, adjustable crimper for Blackburn® compression connectors featuring the Color-Keyed® system

TBM4S dieless crimp tool

Cat. no.	Description	Pkg. qty.
TBM4S	Dieless crimp tool with Shure-Stake mechanism for #8 AWG–250 kcmil copper and #8–4/0 AWG aluminum	1

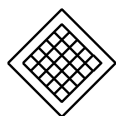

Creates diamond-style crimp

- Wide range of #8 AWG to 250 kcmil for copper and #10 to 4/0 AWG for aluminum lugs and splices
- Also installs C-taps from 54705 to 54750
- Shure-Stake mechanism ensures a properly completed crimp each time
- Includes color-coded, die code-embossed installation dies

TBM5S crimp tool

Cat. no.	Color code	Die cat. no.	Pkg. qty.
TBM5S	Red	13454	1
	Blue		
	Gray		
	Brown	13455	
	Green		
	Pink		
	Black		
	Orange	13456	
	Purple		
	Yellow		
	Gold	13457	
	Tan		
	Olive		
Ruby	13458		
White			

Tools and dies

TBM6S and carrying cases

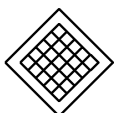

Creates diamond-style crimp

- Wide ranges of #8 AWG thru 500 kcmil for copper lugs, splices and taps and #10 AWG thru 350 kcmil for aluminum lugs and splices
- Also installs 63105 through 63140 orange, green and blue H-taps
- Shure-Stake® mechanism ensures a properly completed crimp each time
- Comes complete with plastic carrying case and wire brush

Note: The TBM6S tool can also be used to crimp Sta-Kon® terminals. See Sta-Kon catalog for dies.

TBM6S crimp tool

Cat. no.	Color code	Cat. no upper die	Cat. no lower die	Pkg. qty.
TBM6S	Red	13475	13477	1
	Blue	13475	13477	
	Gray	13472	13476	
	Brown	13474	13477	
	Green	13474	13477	
	Pink	13475	13477	
	Black	13474	13477	
	Orange	13474	13477	
	Purple	13475	13477	
	Yellow	13473	13476	
	Gold	13474	13477	
	Tan	13475	13477	
	Olive	13475	13477	
	Ruby	13473	13476	
	White	13473	13476	
	Red	13472	13476	
	Blue	13472	13476	
Brown	13478	13478		

Carrying cases for TBM5S and TBM6S

Cat. no.	Description	Pkg. qty.
295-31365M	Steel carrying case for TBM5S and TBM6S	1
295-31365	Plastic carrying case for TBM5S and TBM6S	1

Tools and dies

TBM8S crimp tool

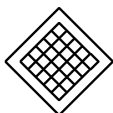

Creates diamond-style crimp

- Installs code copper lugs and connectors #8 AWG through 500 kcmil
- Installs aluminum lugs and connectors #10 AWG through 350 kcmil
- Shure-Stake® mechanism ensures positive compression
- Included dies are color coded and provide die-code embossing for easy installation and inspection
- Installs all code copper compression joints and small C-taps
- Comes complete with installing dies and wire brush in plastic carrying case

TBM8S crimp tool

Cat. no.	Color code	Die cat. no	Pkg. qty.
TBM8S	Red	13461	1
	Blue		
	Gray		
	Brown		
	Green	13462	
	Pink		
	Black		
	Orange		
	Purple	13463	
	Yellow		
	Gold	13464	
	Tan		
	Olive		
	Ruby		
	White	13465	
	Red	13466	
Blue	13467		
Brown	13468		

Tools and dies

BPI42300CR 4-ton inline cordless crimp tool and BP4UCR rechargeable 6-ton crimping tool



Creates hex-style crimp

Lightweight, battery-powered tool.

- Head rotates 180° for ease of use in tight spaces
- Powerful Ni-MH battery yields more crimps per charge
- Bright LED display indicates remaining battery life
- Includes tool, two Ni-MH batteries, battery adapter, battery charger, carrying case and nine hex crimp dies (TBM6221–TBM6266)

Specifications

Installing range:

- Up to 300 kcmil copper lugs and splices
- Up to 4/0 AWG aluminum lugs and splices
- Output force: 4 tons
- Dimensions (L x W x H): 14.6" x 2.6" x 4.2"
- Battery: Ni-MH 9.6 V 3.0 Ah
- Weight with battery: 5.3 lbs.

BPI42300CR 4-ton inline cordless crimp tool

Cat. no.	Description	Pkg. qty.
BPI42300CR	4-Ton inline cordless crimp tool with accessories	1



Great for overhead lines and service connections.

- Jaws rotate 180° for ease of operation in confined spaces
- Ergonomically designed for one-handed operation
- Includes tool, two Ni-MH batteries, battery adapter, recharger and carrying case
- Fixed $\frac{5}{8}$ " (BG) and D groove in tool head
- D groove accepts all W-style dies; also includes fixed O groove

Specifications

- Installing range: service entry connectors requiring $\frac{5}{8}$ " (BG), D or O crimp die
- Output force: 6 tons
- Dimensions (L x W x H): 17.7" x 2.6" x 4.7"
- Battery: Ni-MH 9.6 V 3.0 Ah
- Weight with battery: 5.3 lbs.

BP4UCR rechargeable 6-ton crimping tool

Cat. no.	Description	Pkg. qty.
BP4UCR	Rechargeable 6-ton crimping tool with accessories	1

Tools and dies

Crimp tool and compression tools



Creates diamond-style crimp

- Installs copper and aluminum connectors on wire sizes from #8 AWG to 500 kcmil
- Compact, heavy-duty air tool
- Simple to operate – just insert stripped wire into connector barrel, position it in crimping nest and depress foot pedal to actuate crimping dies
- Uses same crimping dies as TBM6S (see p. 108)

25000 Air-operated bench-mount crimp tool

Cat. no.	Description	Pkg. qty.
25000	Air-operated bench-mount crimp tool	1



Creates hex-style crimp

- Ergonomic design and reduced weight for operator comfort
- New double-speed feature decreases crimp time by doubling jaw speed until it reaches load
- New, more powerful Ni-MH battery has 50% more energy and less memory effect than old batteries
- Rotating head allows maximum flexibility for crimping
- Uses TBM62 Series dies

Specifications

Installing range:

- Up to 500 kcmil copper lugs & splices
- Up to 350 kcmil aluminum lugs & splices
- 54705 to 54750 C-taps
- Output force: 6 tons
- Dimensions (L x W x H): 11" x 3¾" x 11⅞"
- Battery: Ni-MH 14.4 V 3.0 Ah
- Weight with battery: 8 lbs.

Battpac® LT BPLT62BSCR/BPLT62500BSCR 6-ton compression tools

Cat. no.	Description	Pkg. qty.
BPLT62BSCR	Battpac LT tool kit. Includes tool, two batteries, charger, shoulder strap, wrist strap, carrying case (no dies).	1
BPLT62500BSCR	Complete Battpac LT tool kit with dies TBM6221 through TBM6287.	1

Tools and dies

Battpac® LT and TBM6H



Creates hex-style crimp

- Open yoke design allows for maximum crimping flexibility
- New double-speed feature decreases crimp time by doubling jaw speed until it reaches load
- New, more powerful Ni-MH battery has 50% more energy and less memory effect than old batteries
- Uses 6-ton series dies and Blackburn® “O” and “D” Series dies (requires adapter AU-55K, DIEADPODW or DIEADP62); otherwise, uses TBM62 series dies
- Available as a complete kit with 16 TBM series crimp dies for #8 AWG to 500 kcmil copper (#10 AWG to 350 kcmil aluminum)

Specifications

Installing range:

- Up to 600 kcmil copper lugs & splices
- Up to 400 kcmil aluminum lugs & splices
- CHT814-10 to CHT214-9 copper H-taps
- 63105 to 63148 aluminum H-taps
- 54705 to 54750 C-taps
- Output force: 6 tons
- Dimensions (L x W x H): 11" x 3¾" x 11½"
- Battery: Ni-MH 14.4 V 3.0 Ah
- Weight with battery: 8 lbs.

Battpac® LT BPLT6BSCR/BPLT6500BSCR 6-ton compression tools

Cat. no.	Description	Pkg. qty.
BPLT6BSCR	Battpac LT tool kit. Includes tool, two batteries, charger, shoulder strap, carrying case (no dies)	1
BPLT6500BSCR	Battpac LT tool kit with dies. Includes tool, two batteries, charger, shoulder strap, carrying case and 16 crimp dies from TBM6221 through TBM6287	1



- Lightweight design – weighs less than 7 lbs., including dies
- Embosses die code on connection for easy inspection
- Uses 6-ton series and Blackburn® “O” and “D” Series dies color-coded for easy matching with Blackburn connectors featuring the Color-Keyed® system

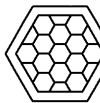

Creates hex-style crimp

Specifications

Installing range:

- Up to 600 kcmil copper lugs & splices
- Up to 400 kcmil aluminum lugs & splices
- CHT814-10 to CHT214-9 copper H-taps
- 63105 to 63148 aluminum H-taps
- 54705 to 54750 C-taps
- Output force: 6 tons
- Operating pressure: 10,000 psi nominal
- Dimensions (L x W x H): 12" x 2¼" x 3⅞"
- Weight without dies: 6.5 lbs.

TBM6H 6-ton hydraulic crimping head

Cat. no.	Description	Pkg. qty.
TBM6H	6-ton hydraulic head with steel case	1
TBM6HD-1	Die set for #8 AWG thru 500 kcmil (6-TON21 thru 6-TON87)	1

Tools and dies

S TBM12 and 13642M



- Rugged steel construction is durable for most applications
- Includes five sets of multi-nested dies
- Dies emboss die code on connectors for easy inspection
- Closed yoke design yields maximum crimp performance
- Uses TBM12D style dies

Specifications

Installing range:

- Up to 900 kcmil copper lugs & splices
- Up to 750 kcmil aluminum lugs & splices
- 54755 to 54775 C-taps
- Output force: 12 tons
- Operating pressure: 10,000 psi nominal
- Dimensions (L x W x H): 14½" x 2½" x 3⅞"
- Weight without dies: 9 lbs.

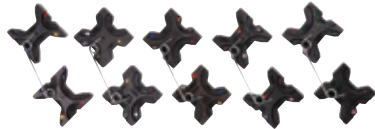

Creates hex-style crimp

S TBM12 12-ton hydraulic crimp head

Cat. no.	Description	Pkg. qty.
TBM12	12-ton hydraulic head with steel case	1

If using old style 11700 series die set, use adapter cat. no. TBM12D-AR for adaptation to the above tool. Order adapter separately.



- Rugged steel construction is durable for most applications
- Used for Blackburn® compression connectors featuring the Color-Keyed® system and Sta-Kon® connectors
- The only military-listed hydraulic head (Mil. Spec. MS25441-1)
- Uses 11700 Series dies for Blackburn connectors; see Sta-Kon section for Sta-Kon dies

Specifications

Installing range:

- Up to 900 kcmil copper lugs & splices
- Up to 750 kcmil aluminum lugs & splices
- 54755 to 54775 C-taps
- Output force: 12 tons
- Operating pressure: 10,000 psi nominal
- Dimensions (L x W x H): 14½" x 2½" x 31⅞"
- Weight without dies: 9 lbs.



Creates hex-style crimp

13642M 12-ton hydraulic crimping head

Cat. no.	Description	Pkg. qty.
13642M	12-ton hydraulic head with steel case	1

Tools and dies

SMART® tools

SMART tools

- Tool is “smart” because it requires no dies
- Automatically compresses to the correct depth based on size of connector in jaws
- C-type head swivels 90° for easy crimp positioning
- Forged steel construction is well suited for both field and bench work
- Installs both Color-Keyed® and non-insulated Sta-Kon® connectors

How the SMART tool works

- The SMART Tool was engineered with built-in intelligence* that enables it to sense the connector barrel diameter and automatically apply just the right amount of compression force. This eliminates virtually all air spaces and forms the connector and conductor strands into a solid mass, resulting in a high-quality, low-resistance connection. In addition, the tool clearly embosses “T&B” with each compression for positive verification that the correct tool was used.

* System Novopress

Uniform, dependable connections

- The SMART Tool gives you consistent, high-quality compression connections over a wide range of connector sizes. Available in manual, battery-powered and air-operated versions, this tool easily installs lugs and splices from #8 AWG through 900 kcmil copper or 750 kcmil aluminum – Without changing dies. For the specified wire range, all you need is one tool. You always have the right die size, eliminating die-selection mistakes.

Lower installation costs

- Productivity will be greatly improved with the SMART Tool, especially when installing a variety of connector sizes or types. Initial investment is low, requiring minimal tool inventory. These benefits add up to lower installed cost.

C-type yoke offers installation convenience

- The C-type yoke configuration and large die spacing enable the SMART Tool to slip directly over the connector. This means added speed and convenience when installing two-way splice connectors, especially in confined spaces.

SMART tool range taking features

- The following size Blackburn® lugs and splices featuring the Color-Keyed® system, when crimped with the SMART Tools, produce these range taking capabilities:

Copper		Aluminum	
Standard wire size (AWG or kcmil)	Range taking (AWG or kcmil)	Standard wire size (AWG or kcmil)	Range taking (AWG or kcmil)
1/0	#6–1/0	1/0	#6–1/0
2/0	#1–2/0	2/0	#1–2/0
4/0	#2–4/0	4/0	#2–4/0
300	2/0–300	300	2/0–300
350	250–350	350	250–350
500	250–500	500	4/0–500
750	500–750	750	500–750

Tools and dies

TBM8-750M-1, Battpac® LT TBM8-750BSCR and TBM8-750



Creates indent-style crimp

Specifications

Installing range:

- Up to 900 kcmil copper lugs & splices
- Up to 750 kcmil aluminum lugs & splices
- Output force: 12 tons
- Dimensions (L x W): 21½" x 47¾"
- Weight: 13 lbs.

TBM8-750M-1 12-ton dieless manual hydraulic tool

Cat. no.	Description	Pkg. qty.
TBM8-750M-1	12-ton dieless manual hydraulic compression tool	1



Creates indent-style crimp

Specifications

Installing range:

- Up to 900 kcmil copper lugs & splices
- Up to 750 kcmil aluminum lugs & splices
- Output force: 12 tons
- Dimensions (L x W x H): 19½" x 37/8" x 8½"
- Battery: NiCd 14.4 V 2.4 Ah
- Weight with battery: 9 lbs.

Battpac LT TBM8-750BSCR 12-ton dieless battery-powered tool

Cat. no.	Description	Pkg. qty.
TBM8-750BSCR	Battpac LT 12-ton dieless battery-powered compression tool. Includes carrying case, charger, two batteries and carry strap.	1



Creates indent-style crimp

Specifications

Installing range:

- Up to 900 kcmil copper lugs & splices
- Up to 750 kcmil aluminum lugs & splices
- Output force: 12 tons
- Operating pressure: 10,000 psi nominal
- Dimensions (L x W x H): 14½" x 47/32" x 29/16"
- Weight: 9 lbs.

TBM8-750 12-ton dieless hydraulic head

Cat. no.	Description	Pkg. qty.
TBM8-750	12-ton dieless hydraulic compression head	1

Tools and dies

TBM14M and TBM14MC



- Features short fiberglass handles for insulation and ease of use in tight spaces
- Two-stage pump provides rapid advance for fast installation
- Uses standard T&B 15500 Series dies

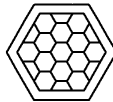

Creates hex-style crimp

Specifications

Installing range:

- Up to 900 kcmil copper lugs & splices
- Up to 750 kcmil aluminum lugs & splices
- CHT814-10 to CHT2502-6 copper H-taps
- 63105 to 63148 aluminum H-taps
- 54755 to 54775 C-taps
- Output force: 14 tons
- Length: 24"
- Weight without dies: 15.4 lbs.

TBM14M 14-ton manual hydraulic crimp tool

Cat. no.	Description	Pkg. qty.
TBM14M	14-ton manual hydraulic crimp tool with case	1



- Improved ergonomic design requires less force
- 180° rotating head for use in tight spaces
- 1.65" jaw opening accommodates large compression terminals and joints
- Dual-speed action pump offers fast advancing speed for approach of die to connector and slower, more powerful speed for crimping
- Built-in safety valve bypasses oil supply at maximum pressure
- Pressure-release system can be easily activated at any stage of compression
- Uses standard T&B 15500 Series dies

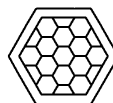

Creates hex-style crimp

Specifications

Installing range:

- Up to 900 kcmil copper lugs & splices
- Up to 750 kcmil aluminum lugs & splices
- CHT814-10 to CHT2502-6 copper H-taps
- 63105 to 63148 aluminum H-taps
- 54755 to 54775 C-taps
- Output force: 14 tons
- Length: 20½"
- Weight without dies: 14 lbs.

TBM14MC 14-ton compact manual hydraulic crimp tool

Cat. no.	Description	Pkg. qty.
TBM14MC	14-ton compact hydraulic crimp tool	1

Tools and dies

Battpac® LT BPLT14BSCR/BPLT14BSCRI and 13100A



BPLT14BSCR



BPLT14BSCRI

- Reduced weight and ergonomic design
- Double-speed feature decreases crimp time by doubling jaw speed until it reaches load
- Rotating head allows maximum flexibility for crimping
- Includes two Makita 14.4 V Ni-MH batteries (3.0 amp hrs.)
- Built-in LED battery power indicator
- On-tool DC power jack



Creates hex-style crimp

Specifications

Installing range:

- Up to 900 kcmil copper lugs & splices
- Up to 750 kcmil aluminum lugs & splices
- CHT814-10 to CHT2502-6 copper H-taps
- 63105 to 63148 aluminum H-taps
- 54755 to 54775 C-taps
- Output force: 14 tons
- Dimensions (L x W x H): 18 $\frac{1}{8}$ " x 3 $\frac{3}{8}$ " x 10"
- Battery: 14.4 V 3.0 Ah Ni-MH
- Weight with battery: 18.1 lbs.

Battpac LT BPLT14BSCR/BPLT14BSCRI 14-ton battery-powered compression tools

Cat. no.	Description	Pkg. qty.
BPLT14BSCR	Battpac LT 14-ton compression tool. Includes carrying case, charger, two batteries, carry strap	1
BPLT14BSCRI	Same as above, but fully insulated	



- Rugged design, made to last in field or on bench
- C-yoke provides maximum flexibility for crimping
- Uses standard T&B 15500 Series dies
- Operates on 10,000-psi hydraulic pumps



Creates hex-style crimp

Specifications

Installing range:

- Up to 900 kcmil copper lugs & splices
- Up to 750 kcmil aluminum lugs & splices
- CHT814-10 to CHT2502-6 copper H-taps
- 63105 to 63148 aluminum H-taps
- 54755 to 54775 C-taps
- Output force: 14 tons
- Operating pressure: 10,000 psi nominal
- Dimensions (L x W x H): 11 $\frac{1}{2}$ " x 2 $\frac{1}{2}$ " x 4 $\frac{1}{4}$ "
- Weight without dies: 10 lbs.

13100A 14-ton hydraulic crimping head

Cat. no.	Description	Pkg. qty.
13100A	14-ton hydraulic head with steel case	1

Tools and dies

Battpac® LT BPLT15BSCR and TBM15I

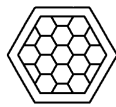

Creates hex-style crimp

- Rotating head allows maximum flexibility for crimping
- Double-speed feature decreases crimp time by doubling jaw speed until it reaches load
- Includes two Makita 14.4 V Ni-MH batteries (3.0 amp hrs.)
- Built-in LED battery power indicator
- On-tool DC power jack

Specifications

Installing range:

- Up to 1500 kcmil copper lugs & splices
- Up to 1000 kcmil aluminum lugs & splices
- CHT814-10 to CHT750-350-1F copper H-taps
- 63105 to 63180 aluminum H-taps
- 54755 to 54790 C-taps
- Output force: 15 tons
- Dimensions (L x W x H): 21" x 3½" x 11"
- Battery: 14.4 V 3.0 Ah Ni-MH
- Weight with battery: 23.75 lbs.

Battpac LT BPLT15BSCR 15-ton battery-powered compression tool

Cat. no.	Description	Pkg. qty.
BPLT15BSCR	Battpac LT 15-ton compression tool. Includes carrying case, charger, two batteries and carry strap	1



- Head made of forged steel and insulated with rubber boot
- Longer, slimmer design enables easier access into tight spaces, such as in cable tray and central office applications
- Wider jaw opening eases crimping of larger lugs, C-taps and H-taps
- Uses 15600 Series dies; can also use 15500 Series dies with 15500-TB adapter

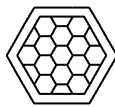

Creates hex-style crimp

Specifications

Installing range:

- Up to 1500 kcmil copper lugs & splices
- Up to 1000 kcmil aluminum lugs & splices
- CHT814-10 to CHT750-350-1F copper H-taps
- 63105 to 36180 aluminum H-taps
- 54755 to 54790 C-taps
- Output force: 15 tons
- Operating pressure: 10,000 psi nominal
- Dimensions (L x W x H): 15¾" x 2⅝" x 4⅜"
- Weight without dies: 16.5 lbs.

TBM15I 15-ton hydraulic crimping head

Cat. no.	Description	Pkg. qty.
TBM15I	Insulated 15-ton hydraulic head with steel case	1

15600 Series – Fits directly into tool for larger size connectors, 800 kcmil–1500 kcmil

15500 Series – Used in conjunction with 15500-TB Adapter, #8 AWG–750 kcmil

Tools and dies

21940, 21940 and Battpac® LT BPLT13970P2



- Compact design delivers maximum pressure for larger lugs and splices
- Ideal for applications requiring larger lugs up to 2000 kcmil
- Uses 11300 and 11400 series dies

Specifications

Installing range:

- Up to 2000 kcmil copper lugs & splices
- Up to 2000 kcmil aluminum lugs & splices
- Output force: 40 tons
- Operating pressure: 10,000 psi nominal
- Dimensions (L x W x H): 12" x 4¾" x 7¾"
- Weight without dies: 40 lbs.



Creates hex-style crimp

21940 40-ton hydraulic crimping head

Cat. no.	Description	Pkg. qty.
21940	40-ton hydraulic head with steel case	1



13606 foot-/hand-operated hydraulic pump

- 13606 operates with either foot or hand; v13604 is hand operated only
- Operates all T&B hydraulic heads
- Built-in safety bypass valve
- Factory set at 9,800 psi

Specifications

- Nominal pressure: 9,800 psi
- Pumping capacity: 2.6 cu. in./min. @ 200 psi 0.16 cu. in./min. @ 10,000 psi
- Reservoir volume: 125 cu. in. (0.54 gal.)
- Max. handle force: 130 lbs.
- Dimensions (L x W x H): 23" x 5¾" x 6¾"
- Weight: 29 lbs.

21940 40-ton hydraulic crimping head

Cat. no.	Description	Pkg. qty.
13606	Combination hand- or foot-operated hydraulic pump	1
13604	Hand-operated hydraulic pump	1

Tools and dies

21940, 21940 and Battpac® LT BPLT13970P2



- Small and lightweight
- 60 minutes full recharge
- Highly visible display indicates battery power level
- Socket for 24 V DC external connection
- Operation in any position: on its side or upright
- Separate operation/release buttons protect against accidental operation
- Energy consumption limited by automatic shut-off
- Easily accessible oil top-up inlet

Specifications

- Nominal pressure: 10,000 psi
- Pumping capacity: 30 cu. in./min.
- Reservoir volume: 60 cu. in. (.26 gal.)
- Dimensions (L x W x H): 13½" x 6½" x 12¾"
- Battery: Ni-MH 24 V, 3 Ah
- Weight with battery: 20.9 lbs.

Battery performance guide

- In tests, the number of crimps obtained from a fully charged battery, using a remote crimping head, was:
 - 102 crimps for Cu connectors on 250 kcmil HD Cu conductor
 - 98 crimps for C-Tap connectors on #2 AWG HD Cu conductor
 - 76 crimps for Cu sleeve connectors on 500 kcmil HD Cu conductor

Battpac LT BPLT13970P2 pump

Cat. no.	Description	Pkg. qty.
BPLT13970P2	Battpac LT pump includes canvas accessories carrying bag, carrying strap, remote hand controller, two batteries, battery charger and non-drip couplings	1
BPLT13970RB	Ni-MH 24 V replacement battery	1
BPLT13970RP	Canvas backpack for pump	1
BPLT13970DC	Power connecting cable with clips	1
BPLT13970FS	Remote foot pedal controller	1

Tools and dies

13600 and 13610A pumps



- Designed for use with single-acting cylinders and tools rated for 10,000-psi operation
- Supplied with metal carrying case
- 13620 hand switch and 13619 hydraulic hose, both sold separately, required for operation

Specifications

- Motor: ½ hp, 115 V, 50–60 Hz, 10 A
- Pumping capacity:
 - 170 cu. in./min. at 100 psi
 - 32 cu. in./min. at 1,000 psi
 - 25 cu. in./min. at 5,000 psi
 - 18 cu. in./min. at 10,000 psi
- Reservoir volume: 104 cu. in. (0.45 gal.)
- Basic pump dimension: 6" x 8" x 16"
- Weight: 25 lbs.

13600 Electric hydraulic pump

Cat. no.	Description	Pkg. qty.
13600	Electric hydraulic pump – hand or foot switch and non-metallic hose (sold separately) required for operation	1
You may also need...		
13620	Hand switch – 10 ft.	1
13589A	Foot switch – 10 ft.	1
13619	10-ft. Non-metallic hose	1
13618	20-ft. Non-metallic hose	1
13600S	"Sled" type stand for 13600 pump	1



- Shure-Stake® control mechanism requires 9,800 psi pump pressure before recycling to prevent under-crimping
- Designed for use with single-acting cylinders and tools rated for 10,000-psi operation
- Supplied with metal carrying case

Specifications

- Motor rating: ½ hp, 115 V, 50–60 Hz, 12.5 A
- Pumping capacity:
 - 170 cu. in./min. at 100 psi
 - 32 cu. in./min. at 1,000 psi
 - 25 cu. in./min. at 5,000 psi
 - 18 cu. in./min. at 10,000 psi
- Reservoir volume: 104 cu. in. (0.45 gal.)
- Basic pump dimension: 8½" x 10½" x 16"
- Weight: 35 lbs.

13610A Electric hydraulic pump with shure-stake® control

Cat. no.	Description	Pkg. qty.
13610A	Electric hydraulic pump with Shure-Stake control – Hand or foot switch and non-metallic hose (sold separately) required for operation	1
You may also need...		
13611	Hand switch – 10 ft.	1
13612	Foot switch – 10 ft.	1
13619	10-ft. Non-metallic hose	1
13618	20-ft. Non-metallic hose	1
13797	Inline gauge	1

Tools and dies

13810 pump and battery connector crimp tools



- Designed for perfect crimps every time in heavy-duty OEM applications
- Heavy-duty OEM two-stage pump with high flow rate
- Shure-Stake® control mechanism requires 9,800-psi pump pressure before recycling to prevent under-crimping
- Requires hand or foot control (sold separately)

Specifications

- Motor rating: 1½ hp, 115 V, 60 Hz, 23 A
- Pumping capacity:
 - 235 cu. in./min. at 200 psi
 - 61 cu. in./min. at 8,000 psi
- Reservoir volume: 462 cu. in./2 gal.
- Dimensions (L x W x H): 10¾" x 15" x 20¾"
- Weight: 60 lbs.

13810 heavy-duty electric hydraulic pump with Shure-Stake control

Cat. no.	Description	Pkg. qty.
13810	Heavy-duty electric hydraulic pump with Shure-Stake control – hand or foot switch and non-metallic hose (sold separately) required for operation	1
You may also need...		
13611	Hand switch – 10 ft.	1
13612	Foot switch – 10 ft.	1
13619	10-Ft. Non-metallic hose	1
13618	20-Ft. Non-metallic hose	1



BCT840, BCT840S



TBM5SV, TBM5V

- Adjustable die crimping tool for Blackburn® cast and tubular battery connectors featuring the Color-Keyed® system
- Available with Shure-Stake® mechanism to ensure a complete crimp every time (BCT840S)
- Crimps casting and tubular battery connectors ranging from #4 AWG to 4/0 AWG
- Heavy-duty crimping tool including die for #8 AWG to 4/0 AWG battery connectors, lugs and splices
- The single die is an integral part of the tool; no dies to lose or misplace
- Available with Shure-Stake mechanism to ensure a complete crimp every time (TBM5SV)

Battery connector crimp tools

Cat. no.	Description	Pkg. qty.
BCT840	Dieless crimp tool for cast and tubular battery connectors	1
BCT840S	Dieless crimp tool with Shure-Stake mechanism for cast and tubular battery connectors	1
TBM5V	Ratchet crimp tool with die for #8 AWG to 4/0 AWG battery connectors	1
TBM5SV	Ratchet crimp tool with Shure-Stake mechanism and die for #8 AWG to 4/0 AWG battery connectors	1

Tools and dies

BCS8-40 and 368-CK cable strippers, 364RF/366RF cable cutters and TBM40HC cutting tool



BCS8-40 cable stripper

Cat. no.	Description	Pkg. qty.
BCS8-40	Cable stripper for #8 AWG to 4/0 AWG battery cable with replacement blade provided in the handle	1



368-CK cable stripper

Cat. no.	Description	Pkg. qty.
368-CK	Cable stripper for #1 AWG to 1000 kcmil	1



364RF/366RF cable cutters with fiberglass handles

Cat. no.	Cable Size	Pkg. qty.
364RF	Cutter for up to 500 kcmil copper and aluminum	1
366RF	Cutter for up to 1000 kcmil copper and aluminum	1

For copper and aluminum cable only. Not for steel.
Replacement blades are available through tool services.



- Specifically designed to cut copper, aluminum and telecommunications cables up to 3.35" O.D.
- Offers dual-speed action: fast advancing speed for rapid approach of blades to cable and slower, more powerful speed for cutting
- Blades manufactured from high-strength, heat-treated steel to ensure long service life
- Head easily opens to enable cutting of existing run cables
- Head rotates 180°, enabling operator to position for easiest use

- Automatic safety valve bypasses oil when reaching maximum pressure
- Pressure release device can also be activated during any point of operation

Specifications

- Max. cutting capacity: 3.35" O.D.
- Dimensions (L x W): 25.69" x 6.89"
- Weight: 14.55 lbs.

TBM40HC hand-operated hydraulic cutting tool

Cat. no.	Description	Pkg. qty.
TBM40HC	Hand-operated hydraulic cutting tool	1

Tools and dies

CSR750 and Battpac® TBM54BSCT/TBM54BSCTS cutters



- Special advance stroke mechanism requires less handle force
- Cuts copper or aluminum cables up to 750 kcmil
- Short handles (only 10" long) enable use in tight spaces

CSR750 cable cutter

Cat. no.	Description	Pkg. qty.
CSR750	Cutter for up to 750 kcmil copper or aluminum	1



- Removable battery – Simply change for continuous use
- One-handed control of blade advancement and retraction
- TBM54BSCTS cuts up to 750 kcmil copper, 2½" O.D. aluminum and 636 kcmil ACSR
- TBM54BSCT cuts up to 1,500 kcmil copper and 2½" O.D. aluminum (not for use on ACSR)

Guide to cutting cycles

This guide indicates the number of cutting cycles that the TBM54BSCT and TBM54BSCTS can be expected to perform when the battery is fully charged. These figures are approximate and will vary according to the charging and other operating conditions, such as temperature, humidity and battery condition.

Specifications

- Motor: 14.4 V DC
- Dimensions (L x W x H): 16" x 4" x 4.5"
- Weight with battery: 7.2 lbs.

Battery cartridge: (CRCTBP)

- Battery type: sealed nickel cadmium
- Voltage: 14.4 V DC
- Rated current: 1.9 Ah
- Dimensions: 3.5"L x 2.7"W x 5.3"H
- Weight: 1.6 lbs.

Battery charger: (CRCTQC)

- Input voltage: 120 V AC single phase
- Charging capacity: 20 V
- Charging time: 15 min. CRCTBP & CRCTBPI
45 min. CRCTBPEI
- Dimensions: 7.5"L x 3.7"W x 3.5"H
- Weight: 4 lbs.

Optional accessories:

- Battery pack: CRCTBPEI
- Battery cartridge: CRCTBPI or CRCTBP
- DC charger: CRCTQC

Battpac TBM54BSCT and TBM54BSCTS battery-powered cutters

Cat. no.	Conductor	Approx. cutting cycles	
		CRCTBPI & CRCTBP	CRCTBPEI
TBM54BSCTS	750 kcmil Cu	35	105
	636 kcmil ACSR	50	150
TBM54BSCT	1000 kcmil Cu	45	135
	1500 kcmil Cu; 2½" Al	30	90

Cat. no.	Description	Pkg. qty.
TBM54BSCTS	Battery-powered cutter for up to 750 kcmil Cu, 2½" O.D. Al and 636 kcmil ACSR	1
TBM54BSCT	Battery-powered cutter for up to 1,500 kcmil Cu, 2½" O.D. Al (not for use on ACSR)	1

Tools and dies

Battpac® LT BPLT58BSCT and 297-32136



- Cuts copper, aluminum and ACSR up to 1½" O.D.
- Also cuts soft steel bolts, rebar and wire rope
- Forged steel head and cutting blades for strength and durability
- Dual forward speeds enhance productivity
- New, more powerful Ni-MH battery has 50% more energy and less memory effect than old batteries

Specifications

Max. cutting capacity:

- Copper, aluminum & ACSR cable to 1½" O.D.
- Rebar, ground rod & standard guy wire to ¾"
- Soft steel bolts to 1½"
- Wire rope to ¾"
- Dimensions (L x W x H): 19½" x 3⅞" x 9⅞"
- Battery: Ni-MH 14.4 V 3.0 Ah
- Weight with battery: 16.7 lbs.

Battpac LT BPLT58BSCT battery-powered cutter

Cat. no.	Description	Pkg. qty.
BPLT58BSCT	Battery-powered cutter with carrying case, charger, two batteries and carry strap	1



- Heavy-duty cutter with high-strength steel blades
- Cuts both aluminum and copper wire to 1½" O.D.
- Cutter supplied with carrying case

Specifications

- Max. cutting capacity (aluminum and copper): 1½" O.D.
- Dimensions (L x W x H): 14½" x 2½" x 4"
- Weight: 8.5 lbs.

297-32136 hydraulic cutting head

Cat. no.	Description	Pkg. qty.
297-32136	Hydraulic cutting head	1

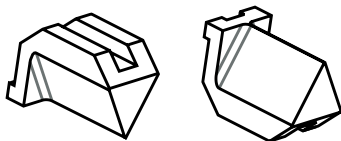

BY55

- Cuts copper and aluminum insulated cable sizes from #8 AWG through 500 kcmil
- Produces clean, squared-end cut, which eliminates extra trimming of conductor strands

Cable slicing die sets

Cat. no.	Maximum cable size (AWG or kcmil)	Tools	Pkg. qty.
BY55	2/0	TBM6H and TBM6BSCR	1
40CS	4/0	TBM14M and 13100A and TBM14BSCR	1
156CS	500	TBM15I and TBM15BSCR	1

Tools and dies

Type WW wire bristle brush, 21649 cable bender and CTR-1 C-tap removal tool



- Removes oxides from conductor surfaces
- Easy-grip handle with guard to prevent rubber-glove puncture
- Replaceable long-life brushes can be rotated
- Handle and guard coated with durable, nonconductive plastic for safety

Type WW wire bristle brush

Cat. no.	Description	Pkg. qty.
WWB1	Complete brush with handle	1
WRB1	Wire element only, pair	1



21649 cable bender

Cat. no.	Description	Pkg. qty.
21649	Bender for cable up to 750 kcmil	1



CTR-1 C-tap removal tool

Cat. no.	Description	Pkg. qty.
CTR-1	C-tap removal tool	1

Tools and dies

TBM25MCC crimp tool, TBM26MCC and TBM60MCC crimping head



- For non-insulated metric connectors
- High-precision treated steel jaws
- Ergonomically designed molded plastic grips
- Compact, lightweight and easy to use
- Toggle-action leverage reduces operator effort
- Shure-Stake® mechanism ensures a properly completed crimp each time
- Automatic handle opening after crimping operation

- **Specifications**
- Wire range: .25–10 sq. mm
- Dimensions (L x W): 9.21" x 2.87"
- Weight: 1.15 lbs.

TBM25MCC crimp tool

Cat. no.	Description	Pkg. qty.
TBM25MCC	Mechanical crimp tool	1



- Installs crimp-type electrical connectors on cables up to 1,000 kcmil
- Includes male automatic coupler for connection to 10,000-psi hydraulic pump
- Optional adapter available for use with semicircular slotted dies common to most C-shaped heads (12-ton) available on the market
- Sturdy steel carrying case complete with die compartment for holding up to 10 sets of dies available on request

- **Specifications**
- Output force: 25.8 tons
- Operating pressure: 10,000 psi nominal
- Dimensions (L x W): 12.4" x 4.7"
- Weight: 11.4 lbs.

TBM26MCC 26-ton hydraulic crimping head

Cat. no.	Description	Pkg. qty.
TBM26MCC	26-Ton hydraulic presshead	1



- Installs crimp-type electrical connectors on cables up to 2,000 kcmil
- Includes male automatic coupler for connection to 10,000-psi hydraulic pump
- Optional adapter available for use with semicircular slotted dies common to most C-shaped heads (12-ton) available on the market
- Sturdy steel carrying case complete with die compartment for holding up to 10 sets of dies available on request

- **Specifications**
- Output force: 58.4 tons
- Operating pressure: 10,000 psi nominal
- Dimensions (L x W): 12" x 7.9"
- Weight: 39.6 lbs.

TBM60MCC 60-ton hydraulic crimping head

Cat. no.	Description	Pkg. qty.
TBM60MCC	60-Ton hydraulic presshead	1

Tools and dies

Dies for standard lugs & splices (TBM45S – TBM12)

Dies for standard lugs & splices (TBM45S – TBM12)

Connector size				TBM8-750M-1 TBM8-750BSCR TBM8-750			TBM-8/8S	TBM-5/5S	TBM6/6S /25000		13642M / 13400 Hydraulic head		TBM12 Hydraulic head			
Code copper (AWG or kcmil)	Flex/24	Al/Cu (AWG or kcmil)	Color code	TBM45S	TBM45S	TBM8-750	TBM8 die cat. no.	TBM5 die cat. no.	Cat. no. upper die	Cat. no. lower die	Die cat. no.	Die cat. no.	Die cat. no.	Die cat. no.		
#8	37/24	#10	Red	C-taps only	↕	↕	-	-	13475	13477	11732	21	TBM12D-1	21		
#6	61/24	#8	Blue				-	-	13475	13477	11733	24	TBM12D-1	24	TBM12D-1	24
#4	91/24	#6	Gray				13461	13454	13472	13476	11734	29	TBM12D-2	29	TBM12D-2	29
#2	125/24	-	Brown				-	-	13474	13477	11735	33	TBM12D-2	33	TBM12D-2	33
#1	150/24	#4	Green				-	-	13474	13477	11736	37	TBM12D-3	37	TBM12D-3	37
1/0	225/24	#2	Pink				-	-	13475	13477	11737	42	TBM12D-3	42	TBM12D-3	42
2/0	275/24	-	Black				13462	13455	13474	13477	11738	45	TBM12D-4	45	TBM12D-4	45
3/0	325/24	-	Orange				-	-	13474	13477	11739	50	TBM12D-4	50	TBM12D-4	50
4/0	450/24	-	Purple				-	-	13475	13477	11740	54	TBM12D-5	54	TBM12D-5	54
250	550/24	-	Yellow				13463	13456	13473	13476	11771	62	TBM12D-5	62	TBM12D-5	62
-	-	#1	Gold	-	-	13474	13477	11738	45	TBM12D-4	45	TBM12D-4	45			
-	-	1/0	Tan	-	-	13474	13477	11739	50	TBM12D-4	50	TBM12D-4	50			
-	-	2/0	Olive	13464	13457	13475	13477	11740	54	TBM12D-5	54	TBM12D-5	54			
-	-	3/0	Ruby	-	-	13473	13476	11741	60	TBM12D-5	60	TBM12D-5	60			
300	-	4/0	White	13465	-	13473	13476	11742	66H	TBM12D-5	66H	TBM12D-5	66H			
350	775/24 (short)	250	Red	13466	13458	13472	13476	11743	71H	TBM12D-4	71H	TBM12D-4	71H			
400	775/24 (long)	300	Blue	134674/0 only		13472	13476	11744	76H	TBM12D-4	76H	TBM12D-4	76H			
-	925/24*	-	-	-	-	13479	13476	11745	80H	-	-	-	-			
-	-	-	-	-	-	-	-	-	-	-	-	-	-			
500	-	350	Brown	13468	-	13478	13478	11746-TB	87H	TBM12D-3	87H	TBM12D-3	87H			
600	1100/24	400	Green	-	-	-	-	11747	94H	TBM12D-3	94H	TBM12D-3	94H			
-	-	-	-	-	-	-	-	-	-	-	-	-	94H			
-	1325/24**	-	Pink	-	-	-	-	-	-	-	-	-	-			
700	-	500	Black	-	-	-	-	11748	99H	TBM12D-2	99H	TBM12D-2	99H			
750	-	650	Black	-	-	-	-	11749	106H	TBM12D-2	106H	TBM12D-2	106H			
800	-	-	Orange	-	-	-	-	11750	107H	-	-	-	-			
-	-	700	Purple	-	-	-	-	11751	112H	TBM12D-1	112H	TBM12D-1	112H			
900	1925/25	750	Yellow	-	-	-	-	11753	115H	TBM12D-1	115H	TBM12D-1	115H			
1000	-	800	-	-	-	-	-	-	-	-	-	-	-			
-	-	1000	-	-	-	-	-	-	-	-	-	-	-			

* Standard barrel only. Long barrel requires brown 87h.
 ** Standard barrel only. Long barrel requires brown 106h.

Tools and dies

Dies for standard lugs & splices (OD58)

Dies for standard lugs & splices (OD58)

Connector size						OD58
Code copper (AWG or kcmil)	Flex/24	Al/Cu (AWG or kcmil)	Color code	Die cat no.	Die code no.	
#8	37/24	#10	Red	BY15C	21	
#6	61/24	#8	Blue	BY17C	24	
#4	91/24	#6	Gray	BY19C	29	
#2	125/24	-	Brown	BY21C	33	
#1	150/24	#4	Green	BY53C	37	
1/0	225/24	#2	Pink	BY23C	42	
2/0	275/24	-	Black	BY28C	45	
3/0	325/24	-	Orange	BY25C	50	
4/0	450/24	-	Purple	BY27C	54	
250	550/24	-	Yellow	BY31C	62	
-	-	#1	Gold	BY24C	45	
-	-	1/0	Tan	BY25C	50	
-	-	2/0	Olive	BY31C	54	
-	-	3/0	Ruby	BY32C	60	

Tools and dies

Dies for standard lugs & splices (BPLT6BSCR – 21940)

Dies for standard lugs & splices (BPLT6BSCR – 21940)

Connector size			BPLT6BSCR/TBM6H							BPLT6BSCR/ BPLT62BSCR	
Code copper (AWG or kcmil)	Flex/24	Al/Cu (AWG or kcmil)	Color code	Die cat. no.	Die code no.	HEX- FLEX® die	HEX- FLEX® die	Die code no.	Die code no.	HEX- FLEX® die	HEX- FLEX® die
						cat. no.	cat. no.			cat. no.†	cat. no.
#8	37/24	#10	Red	6TON21	21	6TON21X	21X	TBM6221	21	TBM6221X	21X
#6	61/24	#8	Blue	6TON24	24	6TON24X	24X	TBM6224	24	TBM6224X	24X
#4	91/24	#6	Gray	6TON29	29	6TON29X	29X	TBM6229	29	TBM6229X	29X
#2	125/24	-	Brown	6TON33	33	6TON33X	33X	TBM6233	33	TBM6233X	33X
#1	140/24	#4	Green	6TON37	37	6TON37X	37X	TBM6237	37	TBM6237X	37X
1/0	225/24	#2	Pink	6TON42	42	6TON42X	42X	TBM6242	42	TBM6242X	42X
2/0	275/24	-	Black	6TON45	45	6TON45X	45X	TBM6245	45	TBM6245X	45X
3/0	325/24	-	Orange	6TON50	50	6TON50X	50X	TBM6250	50	TBM6250X	50X
4/0	450/24	-	Purple	6TON54	54	6TON54X	54X	TBM6254	54	TBM6254X	54X
250	550/24	-	Yellow	6TON62	62	6TON62X	62X	TBM6262	62	TBM6262X	62X
-	-	#1	Gold	6TON45	45	6TON66X	66X	TBM6245	45	-	-
-	-	1/0	Tan	6TON50	50	-	-	TBM6250	50	-	-
-	-	2/0	Olive	6TON54	54	-	-	TBM6254	54	-	-
-	-	3/0	Ruby	6TON60	60	-	-	TBM6260	60	-	-
300	-	4/0	White	6TON66	66H	-	-	TBM6266	66	TBM6266X	66X
350	775/24 (short)	250	Red	6TON71	71H	-	-	TBM6271	71	-	-
400	775/24 (long)	300	Blue	6TON76	76H	-	-	TBM6276	76	-	-
-	925/24*	-	-	6TON80	80H	-	-	TBM6280	80	-	-
-	-	-	-	-	-	-	-	-	-	-	-
500	-	350	Brown	6TON87	87H	-	-	TBM6287	87	-	-
600	1100/24	400	Green	6TON94	94H	-	-	-	-	-	-
-	-	-	Green	-	-	-	-	-	-	-	-
700	1325/24**	500	Pink	-	99H	-	-	-	-	-	-
750	-	650	Black	-	106H	-	-	-	-	-	-
800	-	-	Orange	-	107H	-	-	-	-	-	-
-	-	700	Purple	-	112H	-	-	-	-	-	-
900	1925/24	750	Yellow	-	115H	-	-	-	-	-	-
1000	-	800	-	-	-	-	-	-	-	-	-
-	-	1000	-	-	-	-	-	-	-	-	-
-	-	-	-	-	-	-	-	-	-	-	-

*Standard barrel only. Long barrel requires brown 87h.

**Standard barrel only. Long barrel requires black 106h.

***15500 Series dies require 15500-tb adapter. 15500F for full-size die to fit tbm15i without adapter.

† HEX-FLEX dies are sold separately in halves. The catalog numbers shown in the chart above are for the upper half of the die.

For the bottom half (the indenter), order one cat. No. 6Tonx for all 6tonx series, one cat. No. Tbm62x for all tbm62x series die codes 21x–66x, one cat. No. 15500X for 15500x series die codes 21x–94x and one cat. No. 15600X for all 15600x series die codes 62x–115x.

Tools and dies

Dies for standard lugs & splices (BPLT6BSCR – 21940)

BPLT14BSCR/TBM14M TBM14MC/13100A/JB12B								BPLT15BSCR/ TBM15I***					21940 (40 ton)	
Die cat. no.	Die code no.	HEX- FLEX® die code no.†	HEX- FLEX® die code no.	Die cat. no.	Die code no.	Full die cat. no.	Full die, die code no.	HEX- FLEX® die cat. no.†	HEX- FLEX® die cat. no.	HEX- FLEX® full die cat. no.†	HEX- FLEX® die code no.	Die cat. no.	Die code no.	
15520	21	15520X	21X	15520	21	15520F	21	15520X	21X	-	-	-	-	
15522	24	15522X	24X	15522	24	15522F	24	15522X	24X	-	-	-	-	
15527-CK	29	15527X	29X	15527-CK	29	15527F	29	15527X	29X	-	-	11401	29	
15528	33	15528X	33X	15528	33	15528F	33	15528X	33X	-	-	11402	33	
15513-CK	37	15513X	37X	15513-CK	37	15513F	37	15513X	37X	-	-	11333	37	
15508	42	15508X	42X	15508	42H	15508F	42	15508X	42X	-	-	11334	42	
15526	45	15526X	45X	15526	45	15526F	45	15526X	45X	-	-	11405	45	
15530	50	15530X	50X	15530	50	15530F	50	15530X	50X	-	-	11406	50	
15511	54	15511X	54X	15511	54H	15511F	54	15511X	54X	-	-	11407	54H	
15510-CK	62	15510X	62X	15510-CK	62	15510F	62	15510X	62X	15662X	62X	297-31669-7	62	
15526	45	-	-	15526	45	-	-	-	-	-	-	11405	45	
15530	50	-	-	15530	50	-	-	-	-	-	-	11406	50	
15511	54	-	-	15511	54H	-	-	-	-	-	-	11407	54	
15532-CK	60	-	-	15532-CK	60	15532F	60	-	-	-	-	11408	60	
15534	66	15534X	66X	15534	66	15534F	66	15534X	66X	15666X	66X	11409	66	
15514-CK	71H	15514X	71X	15514-CK	71H	15514F	71	15514X	71X	15671X	71X	11363	71	
15512	76	15512X	76X	15512	76	15512F	76	15512X	76X	15676X	76X	11410	76	
15517	80H	15517X	80X	15517	80H	-	-	15517X	80X	15606X	80X	-	-	
-	-	-	-	15606	80H	-	-	-	-	-	-	-	-	
15506	87H	15506X	87X	15506	87H	15506F	87H	15506X	87X	15687X	87X	11423	87	
-	-	15536X	94X	15611	94H	-	-	15536X	94X	15611X	94X	11364	94	
15536-CK	94H	-	-	15536-CK	94H	-	-	-	-	-	-	-	-	
15505	99H	-	-	15505	99H	15505F	99H	-	-	15605X	99X	11424	99	
15515-CK	106H	-	-	15515-CK	106H	15515F	106H	-	-	15615X	106X	74506	106	
15540	107H	-	-	15608	107H	-	-	-	-	15608X	107X	11425	107	
-	-	-	-	15609	112H	-	-	-	-	-	-	11426	112	
15504	115H	-	-	15504	115H	15504F	115H	-	-	15604X	115X	11308	115	
-	-	-	-	15603	125H	-	-	-	-	-	-	11416	125	
-	-	-	-	15602	140H	-	-	-	-	-	-	11418	140	
-	-	-	-	15601	150H	-	-	-	-	-	-	11419	150	

Tools and dies

Dies for copper H-taps, high-voltage connectors and figure 6 and 8 ground connectors

Dies for copper H-taps

Connector	Color code	13100A/JB12B/TBM14M/ BPLT14BSCR		TBM15I/ BPLT15BSCR
		TBM6H/BPLT6BSCR die no.	die no.	die no.
CHT814-10	Green	6TON37R	15CA37RCH	15CA37RCH
CHT214-9	Brown	6TON71R	15CA71RCH	15CA71RCH
CHT250214-8	Purple	-	15CA80RCH	15CA80RCH
CHT25014-7		-	15CA80RCH	15CA80RCH
CHT2502-6		-	15CA80RCH	15CA80RCH
CHT50010-5	Brown	-	-	15612CH
CHT50040-4		-	-	15612CH
CHT75010-3	Yellow	-	-	15620CH
CHT750350-2		-	-	15620CH
CHT75040-11		-	-	15620CH
CHT750350-1F	White	-	-	15620CHF

Dies for high-voltage connectors

Die code no.	Adapter type**	TBM15I, TBM14M, 13100A	
		Non-adapter type	
29R	15CA29R	-	
33R	15CA33R	-	
37R	15CA37R	-	
42R	15CA42R	-	
45R	15CA45R	-	
49R	15CA49R	-	
54R	15CA54R	-	
60R	15CA60R	-	
66R	15CA66R	-	
71R	15CA71R	-	
76R	15CA76R	-	
87R	15CA87R	-	
94R	15CA94R†	-	
106R	15CA106R†	-	
125R	-	-	15C125R*

*To be used with TBM15I only.

**Use 15500-TB adapter with TBM15I tool.

†Not UL listed in TBM14M/13100A tool.

Dies for figure 6 & figure 8 ground connectors

Connector	Cable element A (AWG or kcmil)	To cable element B (AWG or kcmil)	To ground rod element B	To rebar element B	Die selection	
					Element A	Element B
54855L	#6 Sol. - #2 Str.	#6 Sol. - #2 Str.	-	-	15501A	15501A
54865L	#1 Str. - 250	#6 Sol. - #2 Str.	1/2" - 5/8" Rod	3/8" - 1/2" #3 - #4 Rebar	15G86R	15501A
54875L	#2 Str. - 250	#2 Str. - 250	1/2" - 5/8" Rod	3/8" - 1/2" #3 - #4 Rebar	15G86R	15G86R
54885L	250 - 500	#6 Sol. - #2 Str.	5/8" - 3/4" Rod	5/8" - 3/4" #3 - #4 Rebar	15G126R	15501A
54895L	250 - 500	#2 Str. - 250	5/8" - 3/4" Rod	5/8" - 3/4" #4 - #5 Rebar	15G126R	15G86R
54900L	250 - 500	#2 Str. - 250	5/8" - 3/4" Rod	5/8" - 3/4" #4 - #5 Rebar	15G121R	15G121R

Additional information

We reserve the right to make technical changes or modify the contents of this document without prior notice. With regard to purchase orders, the agreed particulars shall prevail. ABB AG does not accept any responsibility whatsoever for potential errors or possible lack of information in this document.

We reserve all rights in this document and in the subject matter and illustrations contained therein. Any reproduction, disclosure to third parties or utilization of its contents – in whole or in parts – is forbidden without prior written consent of ABB AG.



—
US

ABB Installation Products
Electrification Products division
860 Ridge Lake Blvd.
Memphis, TN 38120
+1 901-252-5000

tnb.abb.com