

# SECTION H



## Table of Contents



Single Pole Plugs and Receptacles



Spider® II Temporary Power Boxes



Temporary Lighting and Maintenance Worklights



### Single Pole Devices

	Page
Series 15 - 150 Ampere, 600V AC/250V DC	
Features and Benefits	H-2
Plugs, Receptacles, Protective Caps and Snap Back Covers	H-3
Tees, Gender Reversing, Replacement Bodies and Accessories	H-4
Specifications and Dimensions	H-5
Series 16 - 300 and 400 Ampere, 600V AC/250V DC	
Features and Benefits	H-2
Plugs and Receptacles	H-6
Receptacles, Terminals, Protective Caps and Weather Protective Covers	H-7
Tees, 3-Fers, Gender Reversing Devices, and Distribution Block	H-8
Replacement Parts, Snap Back Covers and Accessories	H-8
Specifications and Dimensions	H-9
Series 18 - 300 and 400 Ampere, 600V AC/250V DC	
Features, 300 & 400A Plugs	H-10
Replacement Bodies and Accessories	H-10
Specifications and Dimensions	H-10

### Temporary Power

	Page
Spider® II Temporary Power Boxes	
Features and Benefits	H-11
50A and 60A Spider® II Boxes	H-12
Cable Sets, Receptacles and Replacement Parts	H-13
Temporary Power Boxes and Power Cables	H-14
Heavy-Duty Portable Outlet Boxes and Cover Plates	H-15
Temporary Lighting	
Construction Site Lighting	H-16
Maintenance Worklights, Accessories and Replacement Items	H-17
Explosion Proof/Confined Space Lighting	H-17
Pre-Wired Portable Outlet Boxes, Worklights and Accessories	H-18



## Features and Benefits

### Series 15 and 16 - 150, 300 and 400 Ampere, 600V AC/250V DC

Hubbell Wiring Device-Kellems offers a full line of innovative, high quality, Series 15 and Series 16 single pole plugs, receptacles and accessories for the most demanding environments.

Single pole devices are the right choice for supplying temporary electrical power distribution for entertainment, theme parks, carnival equipment, concerts, movie making and numerous other applications requiring temporary power.

Single pole devices have been designed with ease of assembly and disassembly in mind, no special tools are required. A high strength non-conductive retaining screw is all that is needed to securely lock the contacts to the insulated sleeve.

UL Enclosure Types 3R, 4X and 12 Rating suitable for use in almost any environment.



HBL15MBK



HBL15FBK



#### Housing Design

- Insulgrip® style housing for superior gripping, conforms to the user's hand making it easy to connect and disconnect, even with gloves on
- Easily identifiable cable, cut off points for secure fit allows you to easily customize and cut the housing to the required/correct cable size
- Accommodates wide range of cables



#### Contacts

- Provides high contact pressure and vibration resistant connection, which helps reduce operating temperatures and extends product life
- High conductivity brass contact provides improved performance by helping to reduce operating temperatures and extends life



#### Safety

- Rounded corners reduce the possibility of catching or snagging on structures or equipment
- Non-conductive retaining screw locks contacts in place and allows for easy installation; prevents contact movement within housing
- Recessed mounting screw minimizes screwdriver slippage



#### Assembly

- Special screw thread requires fewer turns than most competitors and reduces the risk of a conductive screw being substituted
- Extra long non-conductive inner sleeve reduces force required to install housing over contacts; easier to rotate contact in body for installing retaining screw



#### Identification

- Lock symbol aids in the mating of devices and provides a clear indication that the devices are properly connected
- With lock indicator symbol making mating clear and simple; devices can lock 180° to prevent unintended disconnects



#### Installation

- Engineered body design makes installation simple with no need for additional tools and the non-metallic retaining screw helps to make operation safe for all involved
- Strip gauge molded into every plug and receptacle housing; simplifies installation and saves time

# Single Pole Devices and Temporary Power



Series 15 - 150 Ampere, 600V AC/250V DC

Enclosure Types  
3R, 4X, 12



## Plugs, Male

Description	Color	Male Plug
150 amp, thermoplastic elastomer, cable size #8 - #2 AWG.	Black	<b>HBL15MBK</b>
	White	<b>HBL15MW</b>
	Green	<b>HBL15MGN</b>
	Red	<b>HBL15MR</b>
	Blue	<b>HBL15MBL</b>
	Brown	<b>HBL15MBN</b>
	Orange	<b>HBL15MO</b>
	Yellow	<b>HBL15MY</b>
	Gray	<b>HBL15MGY</b>



## Plugs, Female

Description	Color	Female Plug
150 amp, thermoplastic elastomer, cable size #8 - #2 AWG.	Black	<b>HBL15FBK</b>
	White	<b>HBL15FW</b>
	Green	<b>HBL15FGN</b>
	Red	<b>HBL15FR</b>
	Blue	<b>HBL15FBL</b>
	Brown	<b>HBL15FBN</b>
	Orange	<b>HBL15FO</b>
	Yellow	<b>HBL15FY</b>
	Gray	<b>HBL15FGY</b>



## Receptacles, Stud Type

Description	Color	Female Receptacles	Male Receptacles
150 amp, Panel Mount, thermoplastic, cable size #8 - #2 AWG.	Black	<b>HBL15FRSBK</b>	<b>HBL15MRSBK</b>
	White	<b>HBL15FRSW</b>	<b>HBL15MRSW</b>
	Green	<b>HBL15FRSGN</b>	<b>HBL15MRSGN</b>
	Red	<b>HBL15FRSR</b>	<b>HBL15MRSR</b>
	Blue	<b>HBL15FRSBL</b>	<b>HBL15MRSBL</b>
	Brown	<b>HBL15FRSBN</b>	<b>HBL15MRSBN</b>
	Orange	<b>HBL15FRSO</b>	<b>HBL15MRSO</b>
	Yellow	<b>HBL15FRSY</b>	<b>HBL15MRSY</b>
	Gray*	—	—

Note: \*Gray is available upon request. Contact factory.



## Receptacles, Double Set Screw

Description	Color	Female Receptacles	Male Receptacles
150 amp, Panel Mount, thermoplastic, cable size #8 - #2 AWG.	Black	<b>HBL15FRBK</b>	<b>HBL15MRBK</b>
	White	<b>HBL15FRW</b>	<b>HBL15MRW</b>
	Green	<b>HBL15FRGN</b>	<b>HBL15MRGN</b>
	Red	<b>HBL15FRR</b>	<b>HBL15MRR</b>
	Blue	<b>HBL15FRBL</b>	<b>HBL15MRBL</b>
	Brown	<b>HBL15FRBN</b>	<b>HBL15MRBN</b>
	Orange	<b>HBL15FRO</b>	<b>HBL15MRO</b>
	Yellow	<b>HBL15FRY</b>	<b>HBL15MRY</b>
	Gray	<b>HBL15FRGY</b>	<b>HBL15MRGY</b>



## Protective Caps

Description	Color	Fits Female Devices	Fits Male Devices
Fits 150 amp plugs and receptacles.	Black	<b>HBL15FCAPBK</b>	<b>HBL15MCAPBK</b>
	White	<b>HBL15FCAPW</b>	<b>HBL15MCAPW</b>
	Green	<b>HBL15FCAPGN</b>	<b>HBL15MCAPGN</b>
	Red	<b>HBL15FCAPR</b>	<b>HBL15MCAPR</b>
	Blue	<b>HBL15FCAPBL</b>	<b>HBL15MCAPBL</b>
	**	—	—

Note: \*\*Additional colors are available upon request. Contact factory.



## Weather Protective Covers

Description	Color	Catalog Number
Use with stud type or double set screw receptacles.	Clear	<b>HBL15NCC</b>
	Black	<b>HBL15NCBK</b>
	White	<b>HBL15NCW</b>
	Green	<b>HBL15NCGN</b>
	Red	<b>HBL15NCR</b>
	Blue	<b>HBL15NCBL</b>
	**	

### Tees



Color	Tapping Tee (Female-Female-Male)	Paralleling Tee (Female-Male-Male)
Black	<b>HBL15TBK</b>	<b>HBL15PTBK</b>
White	<b>HBL15TW</b>	<b>HBL15PTW</b>
Green	<b>HBL15TGN</b>	<b>HBL15PTGN</b>
Red	<b>HBL15TR</b>	<b>HBL15PTR</b>
Blue	<b>HBL15TBL</b>	<b>HBL15PTBL</b>

### Gender Reversing Devices



Color	Double Male (Male-Male)	Double Female (Female-Female)
Black	<b>HBL15DMBK*</b>	<b>HBL15DFBK*</b>
White	<b>HBL15DMW</b>	<b>HBL15DFW</b>
Green	<b>HBL15DMGN</b>	<b>HBL15DFGN</b>
Red	<b>HBL15DMR*</b>	<b>HBL15DFR*</b>
Blue	<b>HBL15DMBL*</b>	<b>HBL15DFBL*</b>

Note: \*UL 1691 restricts the use of male-to-male or female-to-female devices to Grounding (Green) or Neutral (White) conductors. Consult factory for availability of other non UL listed colors.

### Replacement Bodies (25 Pack)



Color	Male Body	Female Body
Black	<b>HBL15MBBK</b>	<b>HBL15FBBK</b>
White	<b>HBL15MBW</b>	<b>HBL15FBW</b>
Green	<b>HBL15MBGN</b>	<b>HBL15FBGN</b>
Red	<b>HBL15MBR</b>	<b>HBL15FBR</b>
Blue	<b>HBL15MBBL</b>	<b>HBL15FBL</b>

Note: \*\*Additional colors are available upon request. Contact factory.

### Replacement Contacts (25 Pack)



Description	Male Pin	Female Sleeve
Contact, 150 amp	<b>HBL15RCM</b>	<b>HBL15RCF</b>

### Accessories

Description	Catalog Number
Accessory Kit, retaining screw, copper foil, terminal screws and brass wire.	<b>HBL15PK</b>
Replacement retaining screw (100 pack).	<b>HBL15RS</b>
Copper foil (100 pack).	<b>HBL15CF</b>
Brass wire (100 pack).	<b>HBL15BW</b>
Terminal screw - inline (100 pack).	<b>HBL15TS25</b>
Terminal screw - panel mount (100 pack).	<b>HBL15TS375</b>
Ferrule #2 AWG (100 pack).	<b>HBL15F2</b>
Ferrule #4 AWG (100 pack).	<b>HBL15F4</b>



**HBL15PK**



**HBL15RS**



**HBL15CF**



**HBL15BW**



**HBL15TS25**



**HBL15TS375**



**HBL15F2**  
**HBL15F4**

# Single Pole Devices and Temporary Power



## Series 15 - 150 Ampere, 600V AC/250V DC

### Specifications

Electrical	
Voltage Ratings	600V AC Maximum 250V DC Maximum
Amperage Rating	150A Maximum
Mechanical	
Terminal Accommodation	Plug: #8 AWG to #2 AWG Receptacle: #8 AWG to #2 AWG
Product ID	Ratings are a permanent part of device
Base Compound	Plug: Thermoplastic Elastomer (TPE) Receptacle: Polybutylene Terephthalate (PBT)
Contact Material	Brass
Retaining Screw Material	Nylon

### Certification / Environmental

UL and cUL Listed  
 UL Enclosure Types 3R, 4X, 12  
 UL1691 standard for single pole locking-type separable connectors  
 National Electric Code (NEC®), ANSI/NFPA 70  
 Flammability: HB per UL94 or CSA 22.2. 0.17

### Conductor Ampacity Chart (Type SC/PPC Wire)

Cable Size	Ampacity*
#8	80
#6	105
#4	140
#2	190

Note: \*90°C column NEC Table 400.5(A)(2).

### Dimensions

#### In Line Plugs

	A	B	C	D
Male	4.54" (115.3)	1.04" (26.4)	.86" (21.8)	3.22" (81.7)
Female	4.60" (116.8)	1.11" (28.2)	.68" (17.3)	3.28" (83.2)

#### Weatherproof Cover

	A	B	C
Series 15	2.03" (51.5)	1.14" (29.0)	1.49" (37.9)

#### Male In Line Plug

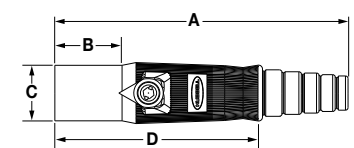

#### Female In Line Plug

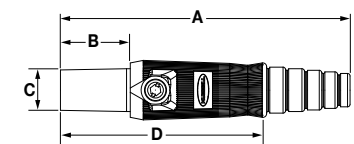

#### Panel Mount Receptacles

Threaded Stud	A	B	C	D	E	F	Mounting Hole	Termination
Male	1.86" (47.2)	1.37" (34.8)	2.82" (71.6)	.86" (22.0)	.80" (20.4)	1.20" (30.5)	Through 3x Ø .20"	5/16-18 Threaded Stud
Female	1.86" (47.2)	1.37" (34.8)	2.88" (73.1)	.86" (22.0)	.80" (20.4)	1.26" (32.0)	Through 3x Ø .20"	5/16-18 Threaded Stud
Double Set Screw	A	B	C	D	E	F	Mounting Hole	Termination
Male	1.86" (47.2)	1.37" (34.8)	2.90" (73.6)	.86" (22.0)	.88" (22.2)	1.20" (30.5)	Through 3x Ø .20"	(2) 5/32 Socket Head Set Screws
Female	1.86" (47.2)	1.37" (34.8)	2.95" (74.9)	.86" (22.0)	.87" (22.2)	1.26" (32.0)	Through 3x Ø .20"	(2) 5/32 Socket Head Set Screws

#### Weatherproof Cover

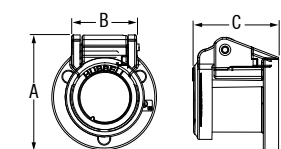

#### Tees

	A	B	C
Tapping Tee	2.67" (67.9)	4.28" (108.7)	.865" (21.9)
Paralleling Tee	2.67" (67.9)	4.22" (107.2)	.865" (21.9)

#### Gender Reversing Devices

	A	B	C
Double Male	4.22" (107.2)	.86" (21.8)	—
Double Female	4.22" (107.2)	1.05" (26.7)	.68" (17.3)

#### Tapping Tee

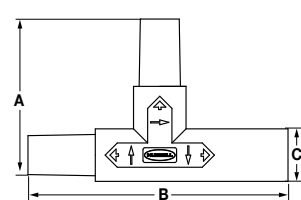

#### Paralleling Tee

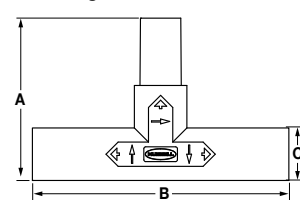

#### Gender Reversing - Double Male

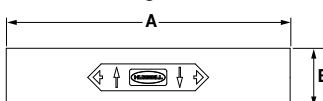

#### Gender Reversing - Double Female

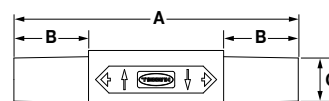

#### Threaded Stud (Male Shown)

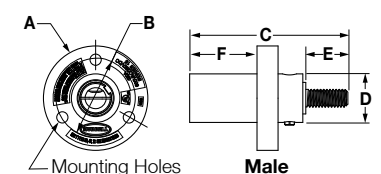

#### Double Set Screw (Male Shown)

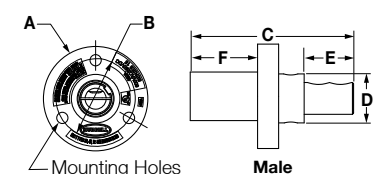

# Single Pole Devices and Temporary Power



Series 16 - 300 and 400 Ampere, 600V AC/250V DC

Enclosure Types  
3R, 4X, 12



## Plugs

Description	Color	Male Plug	Female Plug
300 amp, thermoplastic elastomer, cable size #6 - 2/0 AWG.	Black	<b>HBL300MBK</b>	<b>HBL300FBK</b>
	White	<b>HBL300MW</b>	<b>HBL300FW</b>
	Green	<b>HBL300MGN</b>	<b>HBL300FGN</b>
	Red	<b>HBL300MR</b>	<b>HBL300FR</b>
	Blue	<b>HBL300MBL</b>	<b>HBL300FBL</b>
	Brown	<b>HBL300MBN</b>	<b>HBL300FBN</b>
	Orange	<b>HBL300MO</b>	<b>HBL300FO</b>
	Yellow	<b>HBL300MY</b>	<b>HBL300FY</b>
	Gray*	—	—

Note: \*Gray is available upon request. Contact factory.



## Plugs

Description	Color	Male Plug	Female Plug
400 amp, thermoplastic elastomer, cable size 2/0 - 4/0 AWG.	Black	<b>HBL400MBK</b>	<b>HBL400FBK</b>
	White	<b>HBL400MW</b>	<b>HBL400FW</b>
	Green	<b>HBL400MGN</b>	<b>HBL400FGN</b>
	Red	<b>HBL400MR</b>	<b>HBL400FR</b>
	Blue	<b>HBL400MBL</b>	<b>HBL400FBL</b>
	Brown	<b>HBL400MBN</b>	<b>HBL400FBN</b>
	Orange	<b>HBL400MO</b>	<b>HBL400FO</b>
	Yellow	<b>HBL400MY</b>	<b>HBL400FY</b>
	Gray	<b>HBL400MGY</b>	<b>HBL400FGY</b>

## Receptacles, Stud Type



Description	Color	Through Hole Mounting		Threaded Hole Mounting		Angled Receptacles	
		Female Receptacles	Male Receptacles	Female Receptacles	Male Receptacles	Female Receptacles	Male Receptacles
400 amp Panel Mount, thermoplastic elastomer, mates with 300 and 400 amp plugs.	Black	<b>HBLFRSBK</b>	<b>HBLMRSBK</b>	<b>HBLFRSCBK</b>	<b>HBLMRSCBK</b>	<b>HBLFRASBK</b>	<b>HBLMRASBK</b>
	White	<b>HBLFRSW</b>	<b>HBLMRSW</b>	<b>HBLFRSCW</b>	<b>HBLMRSCW</b>	<b>HBLFRASW</b>	<b>HBLMRASW</b>
	Green	<b>HBLFRSGN</b>	<b>HBLMRSGN</b>	<b>HBLFRSCGN</b>	<b>HBLMRSCGN</b>	<b>HBLFRASGN</b>	<b>HBLMRASGN</b>
	Red	<b>HBLFRSR</b>	<b>HBLMRSR</b>	<b>HBLFRSCR</b>	<b>HBLMRSCR</b>	<b>HBLFRASR</b>	<b>HBLMRASR</b>
	Blue	<b>HBLFRSBL</b>	<b>HBLMRSBL</b>	<b>HBLFRSCL</b>	<b>HBLMRSCBL</b>	<b>HBLFRASBL</b>	<b>HBLMRASBL</b>
	Brown	<b>HBLFRSBN</b>	<b>HBLMRSBN</b>	<b>HBLFRSCBN</b>	<b>HBLMRSCBN</b>	<b>HBLFRASBN</b>	<b>HBLMRASBN</b>
	Orange	<b>HBLFRSO</b>	<b>HBLMRSO</b>	<b>HBLFRSCO</b>	<b>HBLMRSCO</b>	<b>HBLFRASO</b>	<b>HBLMRASO</b>
	Yellow	<b>HBLFRSY</b>	<b>HBLMRSY</b>	<b>HBLFRSCY</b>	<b>HBLMRSCY</b>	<b>HBLFRASY</b>	<b>HBLMRASY</b>

## Receptacles, Double Set Screw



Description	Color	Female Receptacles	Male Receptacles
400 amp, Panel Mount, thermoplastic elastomer, cable size #4 - 4/0 AWG, mates with 300 and 400 amp plugs.	Black	<b>HBLFRBK</b>	<b>HBLMRBK</b>
	White	<b>HBLFRW</b>	<b>HBLMRW</b>
	Green	<b>HBLFRGN</b>	<b>HBLMRGN</b>
	Red	<b>HBLFRR</b>	<b>HBLMRR</b>
	Blue	<b>HBLFRBL</b>	<b>HBLMRBL</b>
	Brown	<b>HBLFRBN</b>	<b>HBLMRBN</b>
	Orange	<b>HBLFRO</b>	<b>HBLMRO</b>
	Yellow	<b>HBLFRY</b>	<b>HBLMRY</b>
Gray	<b>HBLFRGY</b>	<b>HBLMRGY</b>	

## Angled Receptacles, Double Set Screw



Description	Color	Female Receptacles	Male Receptacles
400 amp, Panel Mount, thermoplastic elastomer, cable size #4 - 4/0 AWG, mates with 300 and 400 amp plugs.	Black	<b>HBLFRABK</b>	<b>HBLMRABK</b>
	White	<b>HBLFRAW</b>	<b>HBLMRAW</b>
	Green	<b>HBLFRAGN</b>	<b>HBLMRAGN</b>
	Red	<b>HBLFRAR</b>	<b>HBLMRAR</b>
	Blue	<b>HBLFRABL</b>	<b>HBLMRABL</b>
	Brown	<b>HBLFRABN</b>	<b>HBLMRABN</b>
	Orange	<b>HBLFRAO</b>	<b>HBLMRAO</b>
	Yellow	<b>HBLFRAY</b>	<b>HBLMRAY</b>
	Gray*	—	—

Note: \*Gray is available upon request. Contact factory.

# Single Pole Devices and Temporary Power



Series 16 - 300 and 400 Ampere, 600V AC/250V DC

Enclosure Types  
3R, 4X, 12



## Receptacles, Bus Bar Mount

Description	Color	Female Receptacles	Male Receptacles
400 amp Panel Mount, thermoplastic elastomer, mates with 300 and 400 amp plugs.	Black	<b>HBLFRBBK</b>	<b>HBLMRBBK</b>
	White	<b>HBLFRBW</b>	<b>HBLMRBW</b>
	Green	<b>HBLFRBGN</b>	<b>HBLMRBGN</b>
	Red	<b>HBLFRBR</b>	<b>HBLMRBR</b>
	Blue	<b>HBLFRBBL</b>	<b>HBLMRBBL</b>
	Brown	<b>HBLFRBBN</b>	<b>HBLMRBBN</b>
	Orange	<b>HBLFRBO</b>	<b>HBLMRBO</b>
	Yellow	<b>HBLFRBY</b>	<b>HBLMRBY</b>



## Angled Receptacles, Bus Bar Mount

Description	Color	Female Receptacles	Male Receptacles
400 amp Panel Mount, thermoplastic elastomer, mates with 300 and 400 amp plugs.	Black	<b>HBLFRABK</b>	<b>HBLMRABK</b>
	White	<b>HBLFRABW</b>	<b>HBLMRABW</b>
	Green	<b>HBLFRABGN</b>	<b>HBLMRABGN</b>
	Red	<b>HBLFRABR</b>	<b>HBLMRABR</b>
	Blue	<b>HBLFRABBL</b>	<b>HBLMRABBL</b>
	Brown	<b>HBLFRABN</b>	<b>HBLMRABN</b>
	Orange	<b>HBLFRABO</b>	<b>HBLMRABO</b>
	Yellow	<b>HBLFRABY</b>	<b>HBLMRABY</b>



## Terminals, Offset Straight Style

Description	Color	Female Receptacles	Male Receptacles
400 amp Terminal, thermoplastic elastomer, mates with 300 and 400 amp plugs.	Black	<b>HBLFOSBK</b>	<b>HBLMOSBK</b>
	White	<b>HBLFOSW</b>	<b>HBLMOSW</b>
	Green	<b>HBLFOSGN</b>	<b>HBLMOSGN</b>
	Red	<b>HBLFOSR</b>	<b>HBLMOSR</b>
	Blue	<b>HBLFOSBL</b>	<b>HBLMOSBL</b>
	Brown	<b>HBLFOSBN</b>	<b>HBLMOSBN</b>
	Orange	<b>HBLFOSO</b>	<b>HBLMOSO</b>
	Yellow	<b>HBLFOSY</b>	<b>HBLMOSY</b>

Note: Terminals are UL Type 1 only.



## Angled Terminals, Offset Straight Style

Description	Color	Female Receptacles	Male Receptacles
400 amp Terminal, thermoplastic elastomer, mates with 300 and 400 amp plugs.	Black	<b>HBLFOABK</b>	<b>HBLMOABK</b>
	White	<b>HBLFOAW</b>	<b>HBLMOAW</b>
	Green	<b>HBLFOAGN</b>	<b>HBLMOAGN</b>
	Red	<b>HBLFOAR</b>	<b>HBLMOAR</b>
	Blue	<b>HBLFOABL</b>	<b>HBLMOABL</b>
	Brown	<b>HBLFOABN</b>	<b>HBLMOABN</b>
	Orange	<b>HBLFOAO</b>	<b>HBLMOAO</b>
	Yellow	<b>HBLFOAY</b>	<b>HBLMOAY</b>

Note: Angled terminals are UL Type 1 only.



## Protective Caps

Color	Fits Female Devices	Fits Male Devices
Black	<b>HBLFCAPBK</b>	<b>HBLMCAPBK</b>
White	<b>HBLFCAPW</b>	<b>HBLMCAPW</b>
Green	<b>HBLFCAPGN</b>	<b>HBLMCAPGN</b>
Red	<b>HBLFCAPR</b>	<b>HBLMCAPR</b>
Blue	<b>HBLFCAPBL</b>	<b>HBLMCAPBL</b>
Brown	<b>HBLFCAPBN</b>	<b>HBLMCAPBN</b>
Orange	<b>HBLFCAPO</b>	<b>HBLMCAPO</b>
Yellow	<b>HBLFCAPY</b>	<b>HBLMCAPY</b>



## Weather Protective Lift Covers

Color	Catalog Number	All One Color Caps and Bodies
Clear	—	<b>HBLNCC</b>
Black	<b>HBLNCBK</b>	<b>HBLNCABK</b>
White	<b>HBLNCW</b>	<b>HBLNCAW</b>
Green	<b>HBLNCGN</b>	<b>HBLNCAGN</b>
Red	<b>HBLNCR</b>	<b>HBLNCAR</b>
Blue	<b>HBLNCBL</b>	<b>HBLNCABL</b>
Brown	<b>HBLNCBN</b>	<b>HBLNCABN</b>
Orange	<b>HBLNCO</b>	<b>HBLNCAO</b>
Yellow	<b>HBLNCY</b>	<b>HBLNCAY</b>

# Single Pole Devices and Temporary Power



Series 16 - 300 and 400 Ampere, 600V AC/250V DC

Enclosure Types  
3R, 4X, 12



## Tees and 3-Fers

Color	Tapping Tee (Female-Female-Male)	Paralleling Tee (Female-Male-Male)	3-Fer (Male-Female- Female-Female)	3-Fer (Female-Male- Male-Male)	Soft 3-Fer (Male-Female- Female-Female)	Soft 3-Fer (Female- Male-Male-Male)
Black	<b>HBLTBK</b>	<b>HBLPTBK</b>	<b>HBLM3FBK</b>	<b>HBLF3MBK</b>	<b>HBLM3FSBK</b>	—
White	<b>HBLTW</b>	<b>HBLPTW</b>	<b>HBLM3FW</b>	<b>HBLF3MW</b>	—	—
Green	<b>HBLTGN</b>	<b>HBLPTGN</b>	<b>HBLM3FGN</b>	<b>HBLF3MGN</b>	—	<b>HBLF3MSGN</b>
Red	<b>HBLTR</b>	<b>HBLPTR</b>	<b>HBLM3FR</b>	<b>HBLF3MR</b>	—	—
Blue	<b>HBLTBL</b>	<b>HBLPTBL</b>	<b>HBLM3FBL</b>	<b>HBLF3MBL</b>	—	—
Brown	<b>HBLTBN</b>	<b>HBLPTBN</b>	<b>HBLM3FBN</b>	<b>HBLF3MBN</b>	—	—
Orange	<b>HBLTO</b>	<b>HBLPTO</b>	<b>HBLM3FO</b>	<b>HBLF3MO</b>	—	—
Yellow	<b>HBLTY</b>	<b>HBLPTY</b>	<b>HBLM3FY</b>	<b>HBLF3MY</b>	—	—

## Gender Reversing Devices



Color	Double Male (Male-Male)	Double Female (Female-Female)
Black	<b>HBLDMBK</b>	<b>HBLDFBK</b>
White	<b>HBLDMW</b>	<b>HBLDFW</b>
Green	<b>HBLDMGN</b>	<b>HBLDFGN</b>
Red	<b>HBLDMR</b>	<b>HBLDFR</b>
Blue	<b>HBLDMBL</b>	<b>HBLDFBL</b>
Brown	<b>HBLDMBN</b>	<b>HBLDFBN</b>
Orange	<b>HBLDMO</b>	<b>HBLDFO</b>
Yellow	<b>HBLDMY</b>	<b>HBLDFY</b>

## Distribution Block

Color	(1-Male, 6-Females)
Black	<b>HBL7DBBK</b>
White	<b>HBL7DBW</b>
Green	<b>HBL7DBGN</b>
Red	<b>HBL7DBR</b>
Blue	<b>HBL7DBBL</b>
Brown	<b>HBL7DBBN</b>
Orange	<b>HBL7DBO</b>
Yellow	<b>HBL7DBY</b>



## Replacement Bodies (10 Pack)



Color	Male Body	Female Body
Black	<b>HBLMBBK</b>	<b>HBLFBBK</b>
White	<b>HBLMBW</b>	<b>HBLFBW</b>
Green	<b>HBLMBGN</b>	<b>HBLFBGN</b>
Red	<b>HBLMBR</b>	<b>HBLFBR</b>
Blue	<b>HBLMBBL</b>	<b>HBLFBBL</b>
Brown	<b>HBLMBBN</b>	<b>HBLFBBN</b>
Orange	<b>HBLMBO</b>	<b>HBLFBO</b>
Yellow	<b>HBLMBY</b>	<b>HBLFBY</b>

## Replacement Contacts (20 Pack)



Description	Male Pin	Female Sleeve
Contact, 300 amp	<b>HBL300RCM</b>	<b>HBL300RCF</b>
Contact, 400 amp	<b>HBL400RCM</b>	<b>HBL400RCF</b>

## Snap Back Covers (3R Only)



Color	Through Hole Mounting	Threaded Mounting Holes
Black	<b>HBLSCBK</b>	<b>HBLSCCBK</b>
White	<b>HBLSCW</b>	<b>HBLSCCW</b>
Green	<b>HBLSCGN</b>	<b>HBLSCCGN</b>
Red	<b>HBLSCR</b>	<b>HBLSCCR</b>
Blue	<b>HBLSCBL</b>	<b>HBLSCCBL</b>
Brown	<b>HBLSCBN</b>	<b>HBLSCCBN</b>
Orange	<b>HBLSCO</b>	<b>HBLSCCO</b>
Yellow	<b>HBLSCY</b>	<b>HBLSCCY</b>

## Accessories

Description	Catalog Number
Accessory Kit, retaining screw, copper foil, terminal screws and brass wire.	<b>HBLPK</b>
Replacement retaining screw (500 pack).	<b>HBLRS</b>
Copper foil (500 pack).	<b>HBLCF</b>
Brass wire (500 pack).	<b>HBLBW</b>
Terminal screw - inline (500 pack).	<b>HBLTS</b>
Terminal screw - panel mount (500 pack).	<b>HBLTSR</b>





# Single Pole Devices and Temporary Power



## Series 16 - 300 and 400 Ampere, 600V AC/250V DC

### Specifications

Electrical	Series 16	
Voltage Ratings	600V AC Maximum 250V DC Maximum	
Amperage Rating	400A Maximum	
Mechanical	300A	400A
Terminal Accommodation	Plug: #6 to 2/0 AWG	Plug: 2/0 to 4/0 AWG Recept.: #4 to 4/0 AWG
Product ID	Ratings are a permanent part of device	
Base Compound	Thermoplastic Elastomer (TPE)	
Contact Material	Brass	
Retaining Screw Material	Nylon	

### Certification / Environmental

UL and cUL Listed  
 UL Enclosure Types 3R, 4X, 12  
 UL1691 standard for single pole locking-type separable connectors  
 National Electric Code (NEC), ANSI/NFPA 70  
 Flammability: HB per UL94 or CSA 22.2. 0.17

### Conductor Ampacity Chart (Type SC/PPC Wire)

Cable Size	Ampacity*	Cable Size	Ampacity*
#6	105	2/0	300
#4	140	4/0	405
#2	190		

Note: \*90°C column NEC Table 400.5(A)(2).

### Dimensions

#### In Line Plugs

Description	A	B	C	D
Male	7.01" (178.0)	1.38" (35.1)	1.48" (37.6)	4.78" (121.4)
Female	7.10" (180.5)	1.44" (36.6)	1.06" (27.0)	4.90" (121.3)

#### In Line Plug (Male Shown)

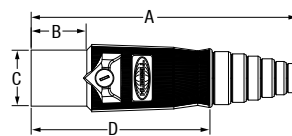

#### Snap Back Cover

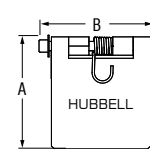

#### Threaded Stud (Male Shown)

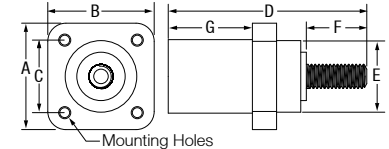

#### Panel Mount Receptacles

Threaded Stud	A	B	C	D	E	F	G	Mounting Hole	Termination
Male & Female with through hole mounting	2.20" (55.9)	2.20" (55.9)	1.50" (38.1)	4.10" (104.3)	1.48" (47.4)	1.25" (31.7)	1.74" (44.2)	Through 4x Ø .20"	1/2-13 UNC-2A Threaded Stud
Male & Female with threaded mounting holes	2.20" (55.9)	2.20" (55.9)	1.50" (38.1)	3.67" (93.2)	1.48" (47.4)	1.11" (28.2)	1.55" (39.4)	Threaded 4x #10-32	1/2-13 UNC-2A Threaded Stud
Double Set Screw	A	B	C	D	E	F	G	Mounting Hole	Termination
Male & Female with threaded mounting holes	2.20" (55.9)	2.20" (55.9)	1.50" (38.1)	4.10" (104.3)	1.48" (47.4)	1.36" (34.5)	1.74" (44.2)	Threaded 4x #10-32	(2) 7/32 Socket Head Set Screws
Busbar Type	A	B	C	D	E	F	G	Mounting Hole	Termination
Male & Female with threaded mounting holes	2.20" (55.9)	2.20" (55.9)	1.50" (38.1)	3.57" (90.7)	1.48" (37.6)	1.01" (25.7)	1.55" (39.4)	Threaded 4x #10-32	(1) 5/16-18 UNC-2B Threaded Hole
Offset Terminals	A	B	C	D	E	F	Mounting Hole	Termination	
Male terminal straight style	Ø1.48" [37.6]	1.00" (25.4)	.38" (9.5)	3.89" (98.8)	1.75" (44.5)	2.14" (54.4)	Through .50" (12.7)		—
Female terminal straight style	Ø1.48" [37.6]	1.00" (25.4)	.38" (9.5)	3.68" (93.3)	1.75" (44.5)	1.93" (48.9)	Through .50" (12.7)		—
Male terminal angled style	Ø1.48" [37.6]	1.00" (25.4)	.38" (9.5)	3.98" (101.1)	2.06" (52.2)	2.14" (54.4)	Through .50" (12.7)		—
Female terminal angled style	Ø1.48" [37.6]	1.00" (25.4)	.38" (9.5)	3.76" (95.6)	2.06" (52.2)	1.93" (48.9)	Through .50" (12.7)		—

#### Double Set Screw (Male Shown)

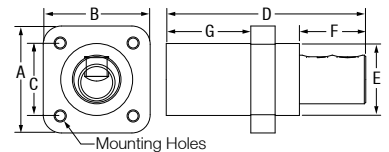

#### Busbar Type (Male Shown)

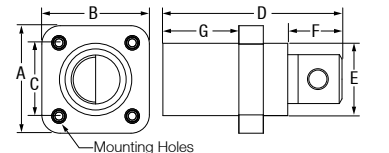

#### Offset Terminals (Male Shown) Straight Style

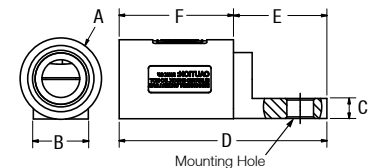

#### Angled Style

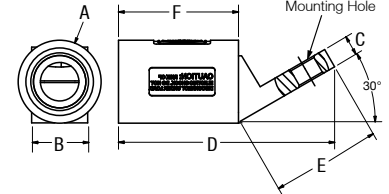

#### Covers

Description	A	B	C
Weatherproof Cover	2.20" (55.88)	1.16" (29.44)	2.03" (51.5)
Snap Back Cover to be used with receptacles	2.26" (57.4)	2.37" (60.2)	—

#### Weatherproof Cover

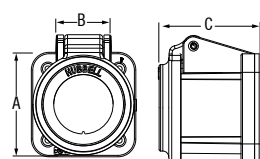

#### Gender Reversing Devices

Description	A	B	C
Double Male	4.65" (118.1)	1.48" (37.6)	—
Double Female	4.84" (122.9)	1.44" (36.6)	1.06" (27.0)

#### Gender Reversing - Double Male

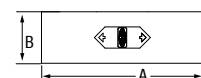

#### Gender Reversing - Double Female

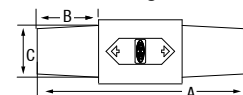

#### Tees and 3-Fers

Description	A	B	C
Tapping Tee	3.18" (80.8)	4.74" (120.4)	1.48" (37.6)
Paralleling Tee	3.18" (80.8)	4.65" (118.1)	1.48" (37.6)
3-Fer	5.88" (149.3)	5.78" (146.9)	1.48" (37.6)

#### Tapping Tee

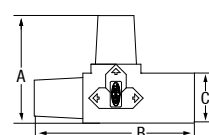

#### Paralleling Tee

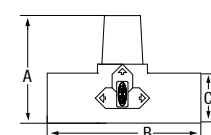

#### 3-Fer

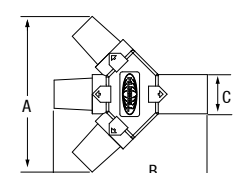

NEC® is a registered trademark of the National Fire Protection Association (NFPA).

Dimensions in Inches (mm)

# Single Pole Devices and Temporary Power



## Series 18 - 300 and 400 Ampere, 600V AC/250V DC

Enclosure Types  
3R, 4X, 12

- Enclosure Types 3R, 4X, 12
- Non-metallic safety retaining screw
- Easy to grip body design
- Accepts #2 to 4/0 AWG wire
- Replacement bodies available
- UL and cULus listed



### 300A Plugs

Description	Color	Male Plug	Female Plug
Thermoplastic elastomer, cable size #2 - 2/0 AWG.	Black	<b>HBL18300MBK</b>	<b>HBL18300FBK</b>
	White	<b>HBL18300MW</b>	<b>HBL18300FW</b>
	Green	<b>HBL18300MGN</b>	<b>HBL18300FGN</b>
	Red	<b>HBL18300MR</b>	<b>HBL18300FR</b>
	Blue	<b>HBL18300MBL</b>	<b>HBL18300FBL</b>
	Brown	<b>HBL18300MBN</b>	<b>HBL18300FBN</b>
	Orange	<b>HBL18300MO</b>	<b>HBL18300FO</b>
	Yellow	<b>HBL18300MY</b>	<b>HBL18300FY</b>

### 400A Plugs

Description	Color	Male Plug	Female Plug
Thermoplastic elastomer, cable size 3/0 - 4/0 AWG.	Black	<b>HBL18400MBK</b>	<b>HBL18400FBK</b>
	White	<b>HBL18400MW</b>	<b>HBL18400FW</b>
	Green	<b>HBL18400MGN</b>	<b>HBL18400FGN</b>
	Red	<b>HBL18400MR</b>	<b>HBL18400FR</b>
	Blue	<b>HBL18400MBL</b>	<b>HBL18400FBL</b>
	Brown	<b>HBL18400MBN</b>	<b>HBL18400FBN</b>
	Orange	<b>HBL18400MO</b>	<b>HBL18400FO</b>
	Yellow	<b>HBL18400MY</b>	<b>HBL18400FY</b>

### Replacement Bodies (10 Pack)

Description	Color	Male Plug	Female Plug
Thermoplastic elastomer.	Black	<b>HBL18MBBK</b>	<b>HBL18FBBK</b>
	White	<b>HBL18MBW</b>	<b>HBL18FBW</b>
	Green	<b>HBL18MBGN</b>	<b>HBL18FBGN</b>
	Red	<b>HBL18MBR</b>	<b>HBL18FBR</b>
	Blue	<b>HBL18MBBL</b>	<b>HBL18FBBL</b>
	Brown	<b>HBL18MBBN</b>	<b>HBL18FBBN</b>
	Orange	<b>HBL18MBO</b>	<b>HBL18FBO</b>
	Yellow	<b>HBL18MBY</b>	<b>HBL18FBY</b>

### Accessories

Description	Catalog Number
Series 18, replacement retaining screw (500 pack).	<b>HBL18RS</b>
Copper foil (500 pack).	<b>HBLCF</b>
Brass wire (500 pack).	<b>HBLBW</b>

### Specifications

Electrical	Series 18	
Voltage Ratings	600V AC Maximum 250V DC Maximum	
Amperage Rating	400A Maximum	
Mechanical	300A	400A
Terminal Accommodation	Plug: #2 to 2/0 AWG	Plug: 3/0 to 4/0 AWG
Product ID	Ratings are a permanent part of device	
Base Compound	Thermoplastic Elastomer (TPE)	
Contact Material	Brass	
Retaining Screw Material	Nylon	

### Certification / Environmental

Series 18
UL and cULus listed
UL Enclosure Types 3R, 4X, 12
UL 1691 standard for single pole locking-type separable connectors
National Electric Code (NEC), ANSI/NFPA 70
Flammability: HB per UL94 or CSA 22.2. 0.17

### Conductor Ampacity Chart (Type SC/PPC Wire)

Cable Size	Ampacity*
#2	190
2/0	300
3/0	350
4/0	405

Note: \*90°C column NEC Table 400.5(A)(2).

### Dimensions

#### In Line Plugs

Description	A	B	C	D	E	F
Male	6.77" (172.0)	2.06" (52.3)	1.61" (40.9)	1.85" (47.0)	.73" (18.5)	.38" (TYP) (9.7)
Female	6.21" (157.7)	1.50" (38.1)	1.61" (40.9)	1.85" (47.0)	.73" (18.5)	.38" (TYP) (9.7)

In Line Plug (Male)

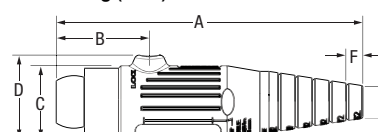

In Line Plug (Female)

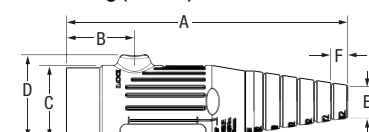

Dimensions in Inches (mm)



## Features and Benefits

### Spider® II Temporary Power Boxes

Hubbell's Spider® II temporary power distribution system sets the safety and performance standard for temporary power needs. Construction sites and outdoor events place more demands on electrical power than ever before. Hubbell's Spider box steps up to the challenge by offering advanced electrical and safety features. The Spider II box incorporates the most advanced ground fault module technology available in the industry today, ensuring safe and reliable distribution of electrical power for a wide variety of temporary power applications.

Breadth of line and durability, Hubbell manufactures a variety of Spider® II Boxes and temporary power products for both indoor and outdoor power and lighting applications. Hubbell's Spider products incorporate the most innovative wiring devices in the Hubbell Safety-Shroud® Twist-Lock® system. The shrouded Twist-Lock design extends the life of the plug by protecting the blades from abuse and more importantly, the shroud protects the user from arcing.



SBSB1A



#### Housing Design

- Individual GFCI modules
- Gasketed latching receptacle lift covers
- Replaceable legs



#### Receptacles

- Six 20 amp straight blade or Twist-Lock® watertight receptacles, individually GFCI protected
- All Pin and Sleeve, Twist-Lock® and straight blade receptacles on each Spider box are protected when not in use by a gasketed, spring loaded flip lid



#### Safety

- Standard stab termination circuit breakers with gasketed lift cover
- Compact electronic supervisory circuit
- Detailed wiring diagram



#### Inlets

- Available with flush 50 amp Twist-Lock® inlet or 60 amp IEC reversed service Pin and Sleeve receptacle



#### Environmental Protection

- Spider® II boxes have earned a Type 3R metallic enclosure rating and heavy duty, abuse resistant legs for outdoor rainproof applications
- Provides UL Type 4X rating when the receptacles are used with Watertight Safety-Shroud® Twist-Lock® plugs



#### Certifications

- Hubbell's Spider® II Boxes meet NEC® requirements for personal protection against electrical shock on job sites and are listed to the latest UL1640 standard for portable power distribution equipment

NEC® is a registered trademark of the National Fire Protection Association (NFPA).



## 50A and 60A Spider® II Boxes



50A Spider® II



60A Spider® II



60A Class "L" Spider® II

### Spider® II Temporary Power Boxes

Rating	Type	Qty	Receptacle Ratings	Receptacle Components	Protection		Catalog Number
					Overload	GFI	
30A, 120/240V AC (Maximum)	Straight Blade	7	20A, 125V	HBL53R61	Yes	Yes	<b>SDSB1A</b>
	Twist-Lock® (inlet)	1	30A, 120/240V	HBL2715SWR	No	No	
	Twist-Lock® (outlet)	1	30A, 120/240V	HBL2710	No	No	
50A, 120/240V AC (Maximum)	Straight Blade	7	20A, 125V	HBL53R61	Yes	Yes	<b>SBSB1A</b>
	Twist-Lock® (inlet)	1	50A, 125/250V	HBL6375S	No	No	
	Twist-Lock® (outlet)	1	50A, 125/250V	CS6369	No	No	
50A, 120/240V AC (Maximum)	Straight Blade	6	20A, 125V	HBL53R61	Yes	Yes	<b>SBSB2</b>
	Twist-Lock®	1	30A, 250V	HBL2620SW	Yes	Yes	
	Twist-Lock® (inlet)	1	50A, 125/250V	HBL6375S	No	No	
	Twist-Lock® (outlet)	1	50A, 125/250V	CS6369	No	No	
50A, 120/240V AC (Maximum)	Twist-Lock®	7	20A, 125V	HBL2310SW	Yes	Yes	<b>SBTL1A</b>
	Twist-Lock® (inlet)	1	50A, 125/250V	HBL6375S	No	No	
	Twist-Lock® (outlet)	1	50A, 125/250V	CS6369	No	No	
50A, 120/240V AC (Maximum)	Twist-Lock®	6	20A, 125V	HBL2310SW	Yes	Yes	<b>SBTL2</b>
	Twist-Lock®	1	30A, 250V	HBL2620SW	Yes	Yes	
	Twist-Lock® (inlet)	1	50A, 125/250V	HBL6375S	No	No	
	Twist-Lock® (outlet)	1	50A, 125/250V	CS6369	No	No	
60A, 3Ø 120/208V AC (Maximum)	Straight Blade	6	20A, 125V	HBL53R61	Yes	Yes	<b>SCSB0*</b>
	Pin and Sleeve (inlet)	1	60A, 3ØY 120/208V	HBL560B9R	No	No	
	Pin and Sleeve (outlet)	1	60A, 3ØY 120/208V	HBL560R9W	No	No	
60A, 3Ø 120/208V AC (Maximum)	Twist-Lock®	6	20A, 125V	HBL2310SW	Yes	Yes	<b>SCTL0*</b>
	Pin and Sleeve (inlet)	1	60A, 3ØY 120/208V	HBL560B9R	No	No	
	Pin and Sleeve (outlet)	1	60A, 3ØY 120/208V	HBL560R9W	No	No	

### Class "L" Spider® II Temporary Power Boxes

Rating	Type	Qty	Receptacle Ratings	Receptacle Components	Protection		Catalog Number
					Overload	GFI	
60A, 3Ø 120/208V AC (Maximum)	Straight Blade	6	20A, 125V	HBL53R61	Yes	Yes**	<b>SCSB0M2</b>
	Class "L" (inlet)	1	60A, 3ØY, 120/208V	—	No	No	
	Class "L" (outlet)	1	60A, 3ØY, 120/208V	—	No	No	
60A, 3Ø 120/208V AC (Maximum)	Twist-Lock®	6	20A, 125V	HBL2310SW	Yes	Yes**	<b>SCTL0M2</b>
	Class "L" (inlet)	1	60A, 3ØY, 120/208V	—	No	No	
	Class "L" (outlet)	1	60A, 3ØY, 120/208V	—	No	No	

Note: \*60A units are UL and cUL only.  
\*\*GFCI protection on 4 devices only.

### Dimensions

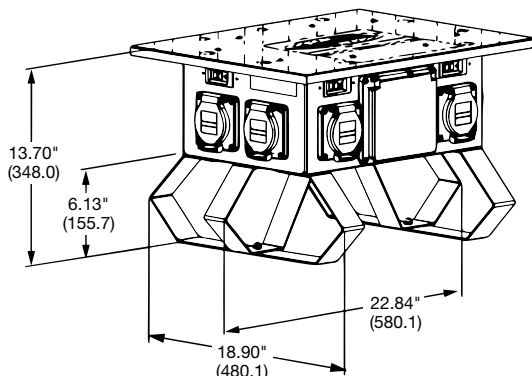

Dimensions in Inches (mm)

### Specifications

#### Spider® II

Listing/Certification	UL1640 cUL and CSA, UL943
Environment	Indoor and outdoor wet and dry locations
Enclosure Type	3R, rainproof, suitable for use in damp locations
Code Compliance	NEC®, ANSI/NFPA 70

NEC® is a registered trademark of the National Fire Protection Association (NFPA).



## Features and Benefits

### Temporary Power Accessories

Hubbell's SR50 is comprised of a pre-wired 50A receptacle, mounted in a fully non-metallic watertight FD wall box.

This weather resistant, UL listed, assembly provides significant labor savings for the contractor, because it's pre-wired with a 50A Twist-Lock® receptacle, installation time is significantly reduced. The 4 hole mounting pattern of the new FD box also provides added security for the device.



### Cable Sets and Receptacles

Description	Catalog Number
50A pre-wired wall mounted receptacle, with 2 ft. wire leads.	<b>SR50</b>
50A cord set - 50 ft. cable (input/output).	<b>SCB50</b>
50A cord set - 100 ft. cable (input/output).	<b>SCB100</b>
60A cord set - 6 ft. cable (input/output).	<b>SCC06</b>
60A cord set - 50 ft. cable (input/output).	<b>SCC50</b>
60A, 3Ø 120/208V Pin and Sleeve wall mounted receptacle.	<b>HBL560R9W</b>
1¼" hub 15 deg. non-metallic angle back box for 60A receptacle.	<b>BB601W</b>
1½" hub 15 deg. metallic 4-way angle back box for 60A receptacle.	<b>FW60100</b>

Note: Consult factory for alternate cable lengths.



SR50



SCB50

### Replacement Parts

Description	Catalog Number
20A, 125V straight blade receptacle.	<b>HBL53R61</b>
20A, 125V Safety-Shroud Twist-Lock® receptacle.	<b>HBL2310SW</b>
30A, 250V Safety-Shroud Twist-Lock® receptacle.	<b>HBL2620SW</b>
30A, 125/250V Reverse Service Safety-Shroud connector.	<b>HBL2713SR</b>
30A, 125/250V Reverse Service inlet.	<b>HBL2715SWR</b>
50A, 125/250V Twist-Lock® receptacle.	<b>CS6369</b>
50A, 125/250V Twist-Lock® inlet.	<b>HBL6375S</b>
60A, 3Ø 120/208V Pin and Sleeve reversed service receptacle (inlet).	<b>HBL560B9R</b>
60A, 3Ø 120/208V Pin and Sleeve receptacle (outlet).	<b>HBL560R9W</b>
60A, 3Ø 120/208V Pin and Sleeve reversed service plug (female).	<b>HBL560P9WR</b>
60A, 3Ø 120/208V Pin and Sleeve plug (male).	<b>HBL560P9W</b>
GFCI module.	<b>GFM20</b>
50A Spider supervisory kit.	<b>SSK</b>
60A Spider supervisory kit.	<b>SSK60</b>
Spider circuit breaker cover.	<b>SCBC</b>
Spider leg kit.	<b>SLK</b>
Spider leg kit, green.	<b>SLKG</b>
50A receptacle cover plate.	<b>HBL77CM74WO</b>



HBL560R9W



HBL2310SW



SCBC



GFM20



SSK



HBL77CM74WO



CS6369



HBL2713SR



## Features and Benefits

### Temporary Power Distribution Boxes and Temporary Power Cables

- Durable hi-visibility yellow powder coated steel construction
- Hubbell 50 amp Twist-Lock® receptacle and inlet
- Six 20 amp straight blade or Twist-Lock® covered receptacles
- Individual GFCI modules
- NEMA 3R enclosure
- Nesting leg design saves space in the warehouse and on the truck



TPDL – Twist-Lock®  
TPDS – Straight Blade



TPC50 – 50' Cable  
TPC100 – 100' Cable



HBLCGFM20

### Temporary Power Distribution Boxes

Rating	Type	Qty	Receptacle Rating	Protection		Catalog Number
				Overload	GFI	
50A, 120/240V AC (Maximum)	Twist-Lock®	6	20A, 125V	Yes	Yes	<b>TPDL</b>
	Twist-Lock®	1	30A, 250V	Yes	No	
	Twist-Lock® (Inlet)	1	50A, 125/250V	No	No	
	Twist-Lock® (Outlet)	1	50A, 125/250V	No	No	
50A, 120/240V AC (Maximum)	Straight Blade	6	20A, 125V	Yes	Yes	<b>TPDS</b>
	Twist-Lock®	1	30A, 250V	Yes	No	
	Twist-Lock® (Inlet)	1	50A, 125/250V	No	No	
	Twist-Lock® (Outlet)	1	50A, 125/250V	No	No	
Replacement GFCI module.						<b>HBLCGFM20</b>

### Temporary Power Cables

Rating	Cable Type	Length	Male Device	Female Device	Weatherproof	Catalog Number
					Boot	
50A, 125/250V	6/3, 8/1	50 ft.	CS6365L	CS6364L	No	<b>TPC50</b>
50A, 125/250V	6/3, 8/1	100 ft.	CS6365L	CS6364L	No	<b>TPC100</b>

### Specifications

#### Boxes

Listings/Certifications	UL1640, UL943
Operation	Indoor and outdoor wet and dry locations
Enclosure Type	3R, rainproof, suitable for use in damp locations
Code Compliance	NEC®, ANSI/NFPA 70

#### Cables

Listings/Certifications	Connectors: UL/CSA; Cable: MSHA
Operation	Indoor and outdoor wet and dry locations

### Dimensions

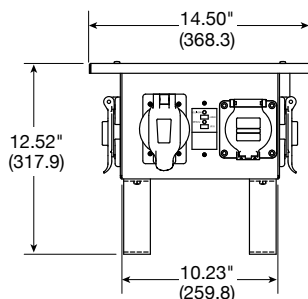

Dimensions in Inches (mm)

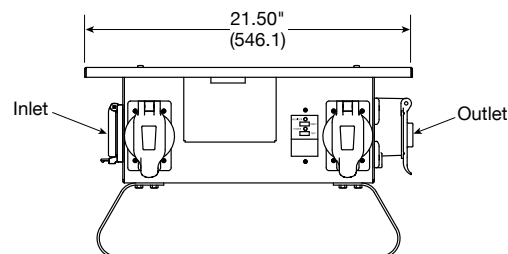

NEC® is a registered trademark of the National Fire Protection Association (NFPA).



## Heavy-Duty Portable Outlet Boxes and Cover Plates

Description	Catalog Number
Box with cord strain relief, with one blank cover plate.	<b>HBLPOB1</b>
Box with cord strain relief, with one blank cover plate, black.	<b>HBLPOB1BK</b>
Box with cord strain relief, with two duplex (indoor) cover plates.	<b>HBLPOB1D</b>
Box with cord strain relief, with two duplex (indoor), yellow cover plates.	<b>HBLPOB1DY</b>
Blank, non-metallic FS cover plate with foam gasket, gray.	<b>HBLP14FS</b>
Duplex, non-metallic FS cover plate, gray.	<b>HBLP8FS</b>
Duplex, non-metallic FS cover plate, yellow.	<b>HBLP8FSY</b>
Single receptacle (1.39"), non-metallic FS cover plate, gray.	<b>HBLP7FS</b>
Single receptacle (1.56"), non-metallic FS cover plate, gray.	<b>HBLP720FS</b>
Rectangular opening, non-metallic FS cover plate, gray.	<b>HBLP26FS</b>



**HBLPOB1**

## Other Cover Plates and Devices

which may be used with Heavy-Duty Portable Outlet Boxes

Description	Catalog Number
Duplex cover plate, weatherproof.	<b>HBL5221, HBL52CM21</b>
Single receptacle (1.39") cover plate, weatherproof.	<b>HBL7423WO, HBL74CM23WO</b>
Single receptacle (1.56") cover plate, weatherproof.	<b>HBL7425WOA, HBL74CM25WOA</b>
Safety-Shroud Twist-Lock® surface receptacles.	<b>HBL2310SR, HBL2320SR, HBL2330SR, HBL2610SR, HBL2620SR</b>



**Cover Plates**

Note: Standard product gray, CM yellow.

## Deluxe Cord Grips Straight Male Thread Nylon Fittings, Stainless Steel Mesh, Liquidtight, for Insulated Cables

Grip Diameter Range Inches (mm)	Thread Size NPT (inches)	Form Size	Catalog Number
.375"-.500" (9.5-12.7)	3/4"	F3	<b>074011335</b>
.500"-.625" (12.7-15.9)	3/4"	F3	<b>074011336</b>
.625"-.750" (15.9-19.0)	3/4"	F3	<b>074011337</b>

## Gray Nylon Cord Connector Straight Male Thread

Grip Diameter Range Inches (mm)	Thread Size NPT (inches)	Form Size	Catalog Number
.375"-.500" (9.5-12.7)	3/4"	F3	<b>SHC1035CR</b>
.500"-.625" (12.7-15.9)	3/4"	F3	<b>SHC1036CR</b>
.625"-.750" (15.9-19.0)	3/4"	F3	<b>SHC1037CR</b>



**Deluxe Cord Grips  
(purchased separately)**

## Specifications for Heavy-Duty Portable Outlet Boxes and Cover Plates

UL Listed	UL514C, UL467 and UL50 Enclosures Types 1, 3R.
CSA Certified	C22.2 No. 18 and C22.2 No. 94 Enclosures Types 1, 3R and C22.2 No. 0.4 (Impedance).
Box Specifications:	
Moisture Resistance	Wet and damp locations, enclosure Type 3R when used with weatherproof cover plates; Dry, indoors locations, enclosure Type 1 with all other cover plates
Flammability	UL94V-0, 94-5VA classification
Operating Temperature	80°C maximum; -35°C minimum
UV Resistance	All materials are UV stabilized
Impact and Crush Resistance	In accordance with UL514C, UL50, C22.2 No. 18 and C22.2 No. 94
Material	Valox®
Cord Connector Materials	Nylon nut; nylon Gotcha® ring; neoprene grommet
Cord Diameter Range	.38" to .75" diameter
Bonding Strap Material	Brass
Threaded Inserts	Brass
Grounding Screw Material	Brass
Indoor Cover Plate Screws Material	Zinc plated steel
Outdoor Cover Plate Screws Material	Stainless steel
Cover Plate Gasket Material	UL recognized closed-cell foam (aging and oil resistant)



**Gray Nylon  
Cord Connector**

## Dimensions

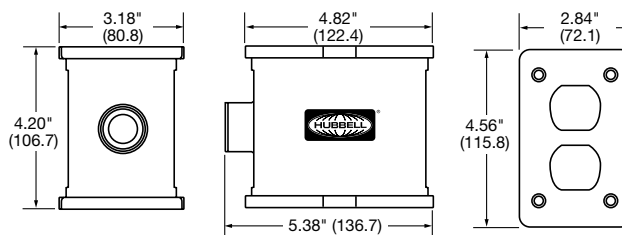

**HBLPOB1**

Valox® is a trademark of SABIC Innovative Plastics, acquired from General Electric Company.

Dimensions in Inches (mm)



## Construction Site Lighting

Hubbell's outdoor approved construction site lighting line includes both heavy duty metal halide lights and light strings for working in rugged environments. The metal halide fixtures feature extremely strong and compact heads with bulbs rated to last 10,000 hours. All frames are powder-coated yellow for safety and are constructed of a durable 1.25 inch, 12 gauge steel tube.

We have light strings for all applications in a variety of models as well as a choice of metal or plastic guards. Light sockets are spaced 10 feet apart and all sockets, plugs, and connectors are molded for added durability. In addition, the highly impact-resistant material makes for easy transportation and storage when not in use. Bulbs can be incandescent, fluorescent or LED. Consider choosing LED lighting for a durable bulb that saves energy, provides instant illumination and are rated to last 50,000 hours.



**HBLMH1000**



**HBLMH400**



**HBLLEDH120**



**HBL182S50LEDH**



**HBL143SJ100PS**



**HBLFS2549**  
Straps not Shown

### Metal Halide and LED Lights

Description	Rating	Watts	Lumen Output	Cord Length	Catalog Number
5 -10 ft. metal halide cart light with portable detachable ballast.	15A 125V	1,000	110,000	—	<b>HBLMH1000</b>
6 -12 ft. metal halide cart light.	15A 125V	2,000	220,000	—	<b>HBLMH2000</b>
High bay metal halide light with wire guard.	15A 125V	400	29,000	3 ft.	<b>HBLMH400</b>
High bay LED light with wire guard.	15A 125V	120	14,000	5 ft.	<b>HBLLEDH120</b>

### LED Stringer Lights

Description	No. of Fixtures	Rating	Cord Type	Lumen Output	Cord Length	Catalog Number
90 LEDs per fixture, light string with magnetic base included.	1	15A 125V	#18/2 SJTW	450*	20 ft.	<b>HBL182S20LED</b>
90 LEDs per fixture, light string.	5	15A 125V	#18/2 SJTW	450*	50 ft.	<b>HBL182S50LED</b>
	10	15A 125V	#18/2 SJTW	450*	100 ft.	<b>HBL182S100LED</b>
60 LEDs per fixture, light string with magnetic base included.	1	15A 125V	#18/2 SJTW	1,100*	20 ft.	<b>HBL182S20LEDH</b>
	5	15A 125V	#18/2 SJTW	1,100*	50 ft.	<b>HBL182S50LEDH</b>
28W High power LED light string with inline ON/OFF switch.	—	15A 125V	#16 AWG SJTOW	2,928	6 ft.	<b>HBLLS2834</b>
Magnetic clip bracket for LED.	—	—	—	—	—	<b>HBLSTMC</b>

Note: \*Lumens per fixture.

### A Type (Edison) Twist-Lock® and Straight Blade Light Strings

Description	Max Watts**	Rating	Cord Type	Fixtures	Cord Length	Catalog Number
Twist-Lock® light string; plastic guards.	150	20A 125V	#12/3 STW	10	100 ft.	<b>HBL123S100PT</b>
	150	20A 125V	#12/3 STJW	10	100 ft.	<b>HBL123SJ100PT</b>
Twist-Lock® light string; metal guards.	150	20A 125V	#12/3 STW	10	100 ft.	<b>HBL123S100MT</b>
Straight Blade light string; plastic guards.	150	15A 125V	#14/2 STJW	10	100 ft.	<b>HBL142SJ100PS</b>
	150	15A 125V	#14/3 STJW	10	100 ft.	<b>HBL143SJ100PS</b>
Straight Blade light string; metal guards.	150	15A 125V	#12/3 STW	10	100 ft.	<b>HBL123S100PS</b>
	150	15A 125V	#12/3 STJW	10	100 ft.	<b>HBL123SJ100PS</b>
Straight Blade light string; plastic guards.	150	15A 125V	#12/3 STW	10	100 ft.	<b>HBL123S100MS</b>
	150	15A 125V	#12/3 STW	5	50 ft.	<b>HBL123S50PS</b>
Straight Blade light string; metal guards.	150	15A 125V	#12/3 STW	5	50 ft.	<b>HBL123S50MS</b>
	—	—	—	—	—	<b>HBLSTPG</b>
Replacement heavy duty metal guard for temporary light strings.	—	—	—	—	—	<b>HBLSTMG</b>

Note: \*\*Max watts per fixture. **HBL143SJ100PS** light strings are rated for 1875 Watts total. The total wattage must be considered when daisy chaining lights strings to each other.

### Fluorescent Light Strings

Description	Wattage	Rating	Cord Type	Lumen Output	Cord Length	Catalog Number
Fluorescent light string, 34.5" single fixture with hanging straps	50	15A 125V	#16 AWG SJTOW	3,750	6 ft.	<b>HBLFS5035</b>
Fluorescent light string, 48.5" single fixture with hanging straps	25	15A 125V	#16 AWG SJTOW	2,125	6 ft.	<b>HBLFS2549</b>





## LED Maintenance Worklights

Description	Outlet Rating	Rating	Wattage	Lumen Output	Cord Type	Cord Length	Catalog Number
LED Industrial maintenance light, 1 vertical hanging hook included.	N/A	15A 125V	20	2400	#16/3 SJEOW	25 ft.	<b>HBLML2825L</b>
LED worklight with end light feature.	N/A	15A 125V	9	920/120	#18/2 SJTOW	25 ft.	<b>HBLWL25LED</b>
LED worklight with end light feature and tool tap.	12 Amp	15A 125V	9	920/120	#16/3 SJTOW	25 ft.	<b>HBLWL25LEDT</b>



## Fluorescent Maintenance Worklights

Description	Outlet Rating	Rating	Wattage	Lumen Output	Cord Type	Cord Length	Catalog Number
Fluorescent worklight with straight blade plug.	N/A	15A 125V	13	825	#16/3 SJTOW	25 ft.	<b>TW25F1</b>
Fluorescent worklight with Twist-Lock® plug and tool tap.	12 Amp	20A 125V	13	825	#16/3 SJTOW	25 ft.	<b>TW25F2</b>
Fluorescent maintenance light, 34.5 in., one vertical hanging hook included.	N/A	15A 125V	50	3750	#16/3 SJEOW	25 ft.	<b>HBLML5025</b>
Fluorescent maintenance light, 48.5 in.	N/A	15A 125V	25	2125	#16/3 SJEOW	25 ft.	<b>HBLML2525</b>
Fluorescent worklight, 45 in., 2 horizontal plastic hangers, 1 attached metal hanging hook included.	N/A	15A 125V	25	2125	#16/3 SJTOW	25 ft.	<b>HBLWL2525</b>



## Accessories and Replacement Items

Description	Catalog Number
Magnetic mounting bracket for ML style lights, 82 lb. capacity.	<b>HBLMLMM</b>
Magnetic mounting bracket for WL style lights, 58 lb. capacity.	<b>HBLWLMM</b>
Replacement rough service fluorescent bulb for 13 watt style lamps.	<b>HBLREPPFB</b>
Metal halide replacement bulb, 400 watts.	<b>HBLREP400MH</b>
Metal halide replacement bulb, 1,000 watts.	<b>HBLREP1000MH</b>
Replacement LED panel fixture, 90 LEDs, 450 lumen.	<b>HBLREP450LED</b>
5 base LED string only, 50 ft., 18/2.	<b>HBLREP182S50</b>
10 base LED string only, 100 ft., 18/2.	<b>HBLREP182S100</b>



**HBLMLMM**



**HBLWLMM**



**HBLREPPFB**



**HBLREP400MH**



**HBLREP1000MH**

## Explosion Proof/Confined Space Lighting

### Hazardous Location Lights

Description	Wattage	Lumen Output	Cord Type	Cord Length	Catalog Number
Fluorescent, Class 1, Div 1 Groups C & D, Class 2, Div 1 Groups F & G, 12V, inline transformer.	26	1800	#16/3 SOW	60 ft.	<b>HBLXF6012V</b>
Incandescent, Class 1, Div 1, Groups C & D, 12V, inline transformer.	75	720	#16/3 SOW	60 ft.	<b>HBLXI6012V</b>
Fluorescent, Class 1, Div 1 Groups C & D, Class 2, Div 1 Groups F & G, 120V, less plug.	26	1800	#16/3 SOW	50 ft.	<b>HBLXF50120V</b>
Incandescent, Class 1, Div 1 Groups C & D, 120V less plug.	100	1230	#16/3 SOW	50 ft.	<b>HBLXI50120V</b>
Fluorescent, non-explosion proof, wet location, 12V, inline transformer.	13	825	#18/2 SJTOW	60 ft.	<b>HBLWT6012V</b>





## Pre-Wired Portable Outlet Boxes, Worklights and Accessories



SPB1

### Pre-Wired Portable Outlet Boxes

Description	Catalog Number
25 ft. with 2-15A, 125V, straight blade single receptacles and 1-15A, 125V straight blade plug and boot.	<b>SPB1</b>
25 ft. with 2-20A, 125V, Twist-Lock® single receptacles and 1-20A, 125V Twist-Lock® plug and boot.	<b>SPB2</b>



SPB2

### Worklights and Accessories

Description	Catalog Number
Temporary low voltage worklight with cigarette lighter plug, 20 ft. cord.	<b>TWLV20F</b>
Non-metallic temporary worklight hook.	<b>TWH</b>



TWLV20F

### Specifications

#### Temporary Worklights

Listing/Certification	UL298 and cUL portable electric hand lamps
Environment	Dry, indoor locations
Fluorescent Lamp	13 watt twin tube only

#### Battery Pack and Charger

Environment	Indoor and outdoor dry locations
Fluorescent Lamp Life	Fully charged-5 hour approx
Charge Time	Fully charged-16 hours approx
Battery Rating	12 volt



TWH

### Light Fixture

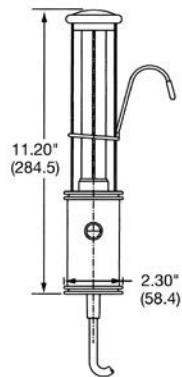

### Worklight Hook

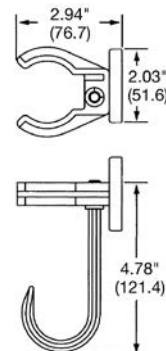

Dimensions in Inches (mm)