

A photograph of an industrial facility, likely a power plant or refinery, featuring extensive metal scaffolding and cable trays. The foreground shows a large, multi-level structure with numerous metal beams and pipes. In the background, there are tall towers and cranes under a clear sky. The overall scene is a complex industrial environment.

Cable Tray Design Considerations Guide

For commercial & industrial applications



Powering Business Worldwide



Cable tray design considerations guide for commercial & industrial applications

Is your cable tray system optimized for safety, dependability, space and cost savings?

Cable tray (or cable ladder) systems are a popular alternative to electrical conduit systems, as they have an outstanding record for dependable service, design flexibility and cost savings in commercial and industrial applications. A properly designed and installed cable tray system will provide outstanding reliability for a facility's control, communication, data, instrumentation and power systems cabling & wiring.

However, if cable tray is not properly designed to be compatible with its application and environment, electrical system failures can occur. This could cost millions of dollars in downtime and cause serious safety problems for a facility and its personnel.

Our **Cable Tray Design Considerations Guide** details key factors to consider when designing cable tray systems for industrial and commercial applications. It also demonstrates how Eaton's solutions and services can help:

- Maximize the return on your capital investment
- Avoid unnecessary power outages and system failures
- Avoid costly downtime and maintenance

As an industry leader in cable tray, Eaton offers one of the widest ranges of cable management solutions available in the market today with its B-Line series portfolio. With unmatched quality and service, we offer a variety of styles, materials and finishes to support virtually any cable management application requirement.

De-risk your cable tray investment with Eaton's B-Line series solutions

Key factors to consider for cable tray installations in indoor & outdoor commercial and industrial applications

- Types of cable tray 4
- Cable tray lengths and best practices with splice plate and support locations 6
- Cable tray strength and load capacity..... 8
- The differences between NEC and IEC cable tray 12
- Understanding thermal contraction and expansion..... 14
- Cable tray materials and applications 16
- Cable tray corrosion factors..... 20
- Cable ladder for use in extreme temperatures 22
- Determining cable width requirements..... 24
- Typical cable tray layout and nomenclature..... 27
- Best practices for driving structural steel savings and lowering total installed costs..... 28
- Optimize weight savings in offshore applications 31



For information on our global portfolio of cable tray and ladder systems, visit our website at www.eaton.com/cabletray



 SCAN ME

Types of cable tray

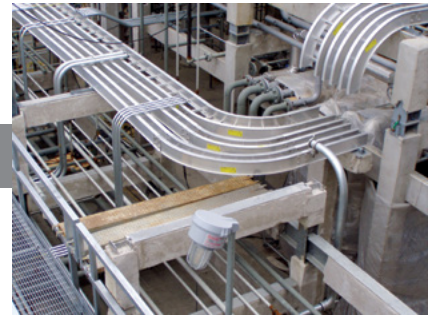

Ladder cable tray

Ladder cable tray is the most widely used cable tray in industrial and commercial applications, due to several desirable design features:

- The rungs provide a convenient anchor for tying down cables in vertical runs or where the positions of the cables must be maintained in horizontal runs.
- Cables may exit or enter through the top or the bottom of the tray.
- Ladder cable tray without covers provides for maximum air flow, dissipating heat produced in current carrying conductors.
- Dust buildup is minimal compared to other types of cable tray, such as ventilated trough or solid bottom. In areas where there is the potential for dust to accumulate, ladder cable trays should be installed.
- Moisture cannot accumulate and be piped into electrical equipment as happens in conduit systems.
- Hazardous or explosive gases cannot be piped from one area to another as happens with conduit systems.

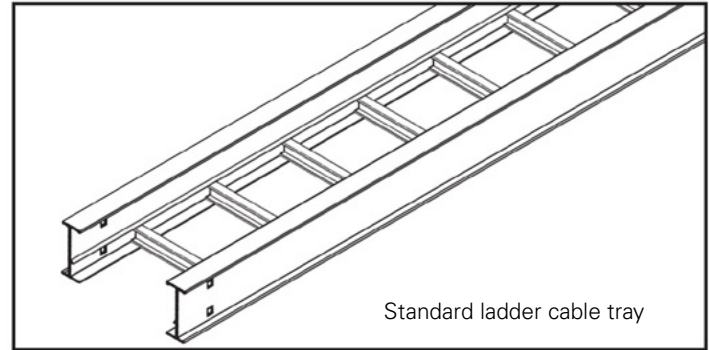

Ladder cable tray is available in widths of 6, 9, 12, 18, 24, 30, 36, 42 and 48 inches with rung spacings of 6, 9, 12 or 18 inches.

Note that wider rung spacings and wider cable tray widths decrease the overall strength of the cable tray. Specifiers should be aware that some cable tray manufacturers do not account for this load reduction in their published cable tray load charts. **Eaton's B-Line series wide cable trays use stronger rungs to safely bear the loads published (only our 42 and 48-inch widths require load reductions).**

Design recommendations for ladder cable tray

When supporting *small diameter multi-conductor control and instrumentation cables*, 6, 9, or 12-inch rung spacings should be specified. Quality Type TC, Type PLTC, or Type ITC small diameter multi-conductor control and instrumentation cables will not be damaged due to the cable tray rung spacing selected, but the installation may not appear neat if there is significant drooping of the cables between the rungs. Refer to wire manufacturer details for unsupported deflection and stress limitations



Small diameter multi-conductor cables

For ladder cable trays supporting *large power cables*, 9-inch or wider rung spacings should be selected. For many installations the power cables will exit out the bottom of the cable tray and into the top of the equipment. The cable manufacturer's recommended minimum bending radii for the specific cables must not be violated.



Large power cables

If the rung spacing is too close, it may be necessary to remove some rungs in order to maintain the proper cable bending radii. This field modification can usually be avoided by selecting a cable tray with 12 or 18-inch rung spacing. Always contact your cable tray manufacturer before removing or modifying ladder.



Eaton delivers versatility in cable pathways to simplify & speed installations

B-Line series Redi-Rail cable tray systems feature rungs with patented fastener holes, allowing installers to easily remove, reposition or add rungs. Pre-punched holes on the I-beam side rails allow for simple attachment of accessories without drilling.

Solid bottom trough cable tray

Some designers/specifiers utilize solid bottom cable tray to support a large number of small diameter control and multi-conductor instrumentation cables. Solid bottom steel cable trays with solid covers and wrap around cover clamps can be used to provide EMI/RFI shielding protection for sensitive circuits.

Important design note - Unlike ladder and ventilated cable trays, solid bottom cable trays *can collect and retain moisture*.

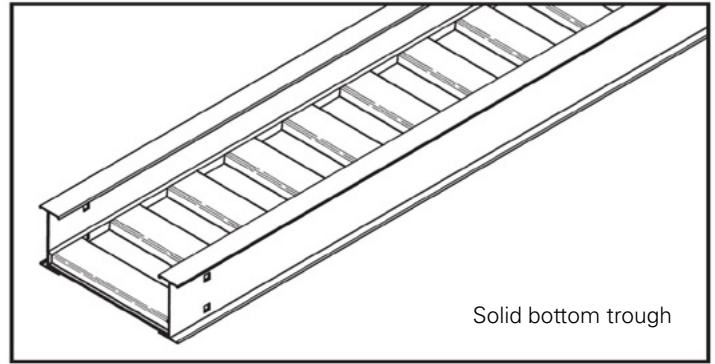

Solid bottom trough

When solid bottom trough tray is installed outdoors, or indoors in humid locations, and EMI/RFI shielding protection is not required, it is recommended that $\frac{1}{4}$ " weep holes be drilled into the tray bottoms at the sides and in the middle every 3 feet to limit water accumulation.

Channel cable tray

Available in 3, 4, and 6-inch widths with ventilated or solid bottoms, channel cable tray is ideal for smaller instrumentation cables and cable tray runs involving a small number of cables.

Channel tray is also an effective alternative to large conduits for supporting cable drops from the main cable tray run to the equipment or device being serviced.

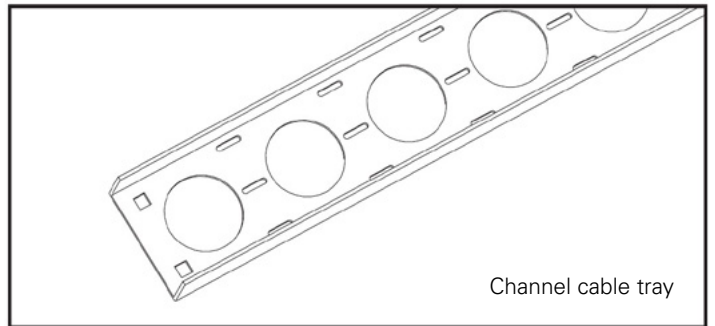

Channel cable tray

When using ventilated channel tray, small diameter cables may exit through the bottom ventilation holes, out the top or through the end.

Design recommendation for channel cable tray

For installations where cables exit the bottom of the cable tray, and the overall system is subject to vibration, it is advisable to use **B-Line series Cable Channel Bushings (Cat. No. 99-1125)**. These snap-in bushings provide additional abrasion protection for the cable jackets.

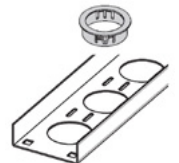

Cable channel bushings

New KwikSplice Cable Channel features optimized design for maximum performance, material savings, and field efficiency

B-Line series KwikSplice cable channel features a continuous "dove-tail" splice design that provides superior strength and reduced deflection. KwikSplice supports loads up to 10lbs. per foot at 20ft spans with less supports required, delivering significant structural steel savings.

The perforated hole pattern in the tray base provides ventilation, NEC heat compliance and serves as attachment points for our wide range of accessories.

The dove tail splice design, along with a complete package of quick-connect accessories, simplifies and speeds tray installation, with the capability to easily make field modifications as necessary.

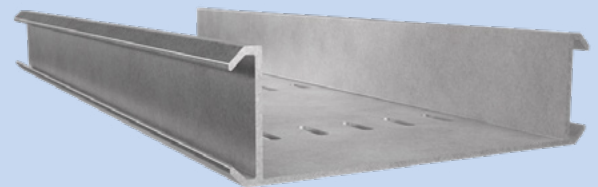

B-Line series KwikSplice cable channel - Industrial strength tray engineered to support 10lbs per foot on 20ft span tray



Cable tray lengths, splice plates & support locations



Cable tray lengths and spans

The standard NEMA lengths for cable tray are 12, 20, 24 and 30-feet, although some manufacturers like Eaton offer cable tray in lengths up to 40 feet. Selecting a cable tray length is based on several criteria, including:

- The required load that the cable tray must support. This includes both the cable load and environmental loads like wind, snow, ice (*See Cable Tray Strength and Load Capacity section in this guide*).
- The distance between the cable tray supports (span)
- The ease of handling and installation

Cable trays can be organized into 4 span categories:

- Short Span
- Intermediate Span
- Long Span
- Extra-Long Span

Short Span trays, often used for non-industrial indoor installations, are typically supported every 6 to 8-feet, while **Intermediate Span** trays are typically supported every 10 to 12-feet. A 10 or 12-foot cable tray is usually used for both of these installation types. **Long Span** trays are typically supported anywhere from 14 to 20-foot intervals, with 20 -feet being the most popular. **Extra-Long Span** trays are supported on intervals exceeding 20-feet. Some outdoor cable tray installations may have to span anywhere from 20 to 40-feet to cross roads. Extra-long spans are also used to help reduce the required number of expensive outdoor supports.

In long and extra-long span installations, the placement of splice plate locations become much more important. Additionally, the distance between supports affects the tray strength exponentially. Therefore, the strength of the cable tray system selected should be designed around the specific support span chosen for that run.

Design recommendations for splice plates and support locations

Splice plates connect two pieces of cable tray together. The *support span* is the distance of cable tray between supports. Your cable tray length must always be longer than or equal to the support span you have selected.

It is strongly recommended that only one cable tray splice plate be placed between support spans. Matching the tray length to your support span can help control your splice locations.

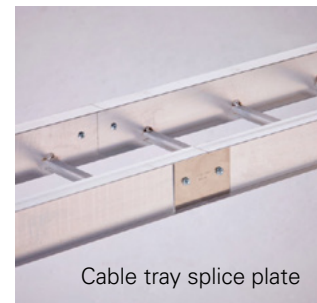

Up to 50% faster to install with fewer parts to manage

Eaton's B-Line series KwikSplice cable tray features an innovative I-beam side rail with a splice-retention groove that allows installers to easily guide and snap the splice plate into position. Once in place, it requires just two bolts to secure and maintain structural integrity and electrical grounding.

Rated for NEMA 12A and 12B (CSA class C-3m and D-3m) load classes, KwikSplice cable tray is ideal for commercial, light-industrial, and data center installations utilizing small power and instrumentation cable management.

Cable tray support locations are defined by the **NEMA VE-1 and VE-2 Manufacturing & Installation Standards**, which specify the requirements for cable tray systems designed for use in accordance with the rules of the National Electrical Code (NEC) and the Canadian Electrical Code (CEC).

NEMA VE-2 defines three support location methods:

- ¼ Span – supports placed at 1/4 span away from a splice plate location on continuous cable tray runs
- Mid-Span – supports placed at 1/2 span away from a splice plate location on continuous cable tray runs
- Simple Beam or Over Support Span – supports placed directly under a splice plate location on continuous cable tray runs

For best system performance, the recommended support location is “1/4 span”, as this method minimizes system stress and deflection at the splice location.

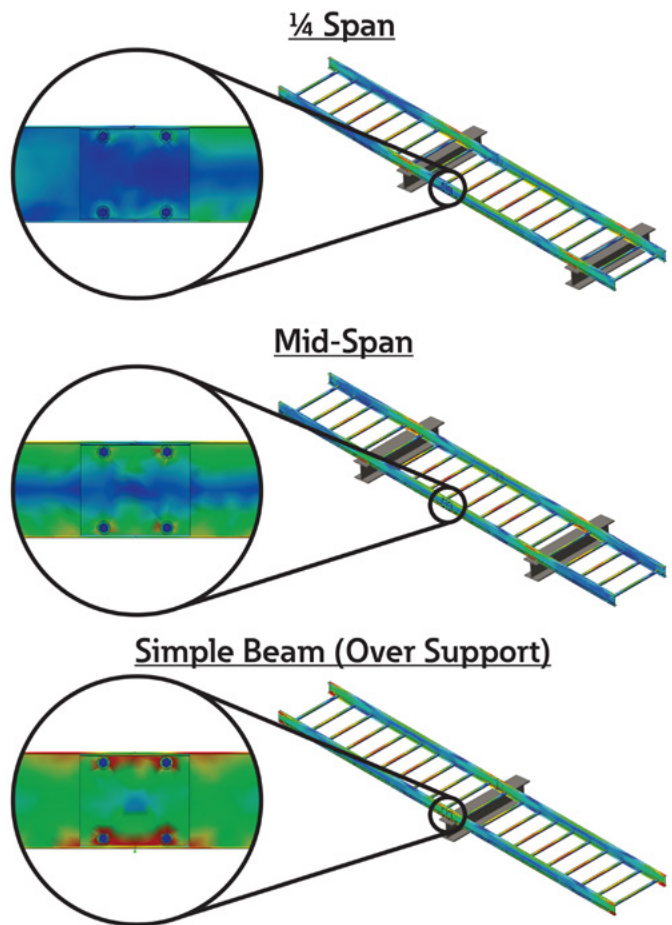
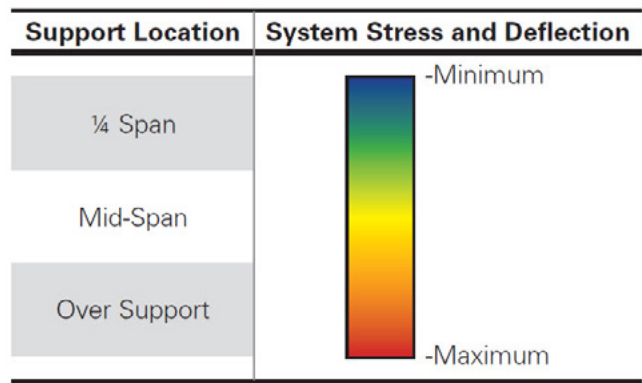

Eaton can help you eliminate costs in both labor & support materials on any given project

By incorporating Eaton’s support recommendations with straight sections, cable tray fittings, vertical adjustable splice plates and heavy duty expansion splice plates, B-Line series cable ladder solutions can help eliminate substantial project costs.

Our [Structural Steel Savings Support Recommendation Guide](#) provides an overview of Eaton’s recommendations for structural steel supports using Eaton’s B-Line series imperial and metric cable ladder, fittings and splice plates.

The guide includes detailed submittal drawings for various cable tray bend and tee configurations.

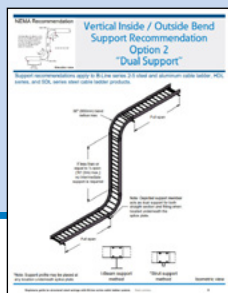
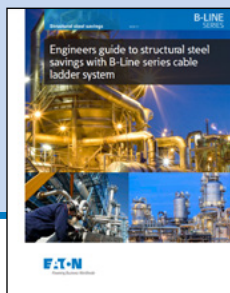

Scan code to visit our Structural Steel Savings web page

Cable tray strength and load capacity



One of the most important elements of designing and specifying a safe and reliable cable tray system is ensuring that it's structurally sufficient for its application.

Cable tray must be capable of supporting not just the weight of the cable, but also the weight of any equipment or materials attached to the cable tray. Additionally, dynamic environmental elements such as ice and snow accumulation, high winds and even earthquakes must be taken into consideration. This total weight is referred to as the cable "load".

NEMA load classes

The NEMA VE-1 Manufacturing Standard defines a cable tray's load class by using a combination of a number and a letter.

- The number defines the **span** of the cable tray in feet between supports
- The letter defines the cable tray **load** in pounds per foot

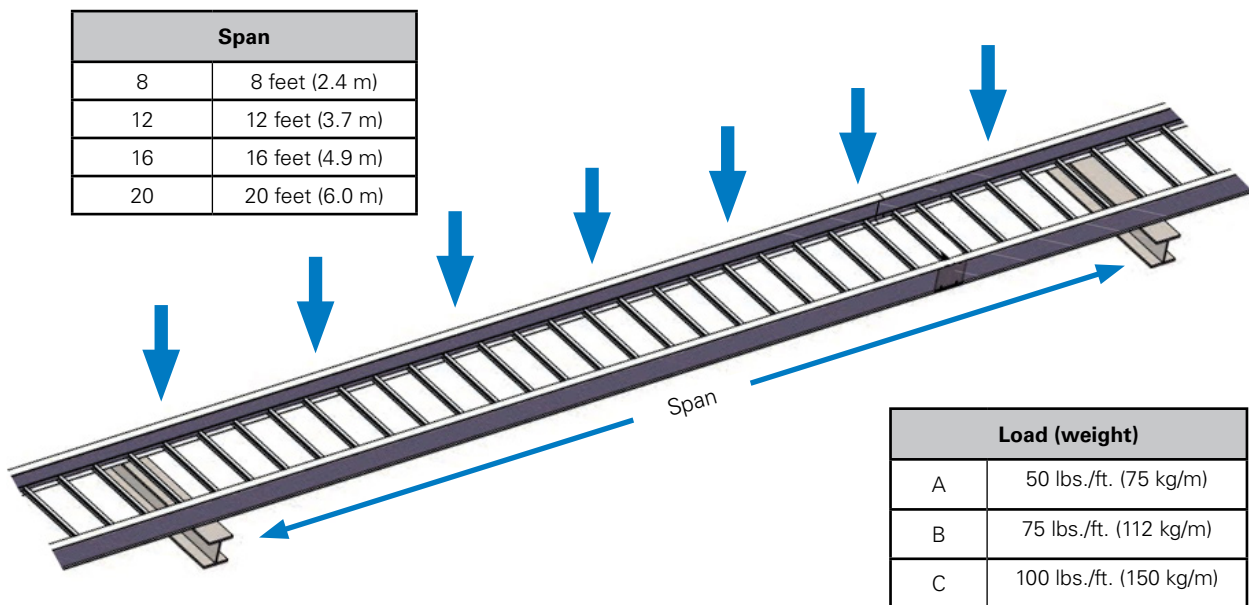

Historically, NEMA has used four span categories (8, 12, 16, 20) and three load designations (A, B, C). For example, a "20C" tray is strong enough to support 100 lbs./ft. of weight when the tray is supported every 20 ft.

However, tray load ratings are no longer limited to the four spans and three loads listed above. NEMA VE-1 now requires the marking on the cable trays to indicate the exact rated load on a particular span. A tray may be rated for 150 lbs/ft on a 30 ft. span.

It is recommended when designing cable tray to specify the required load, support span and straight section length to best match the installation. This information should be properly identified on drawings, specifications, quotation requests and purchase requisitions to guarantee that the cable tray with the proper characteristics will be received and installed.

Calculating the cable load per foot

Cable load per foot can be calculated using the cable manufacturer's literature. Below is an example:

Cable Type	Quantity	Weight	Total
3/C No. 4/0	10	2.62 lbs/ft	26.20 lbs/ft
3/C No. 250 kcmil	3	3.18 lbs/ft	9.54 lbs/ft
3/C No. 500 kcmil	4	5.87 lbs/ft	23.48 lbs/ft

Total weight of the cables = **59.22 lbs/ft**

If these cables above would completely fill a 30-inch wide cable tray, selecting a 36-inch wide tray in your design would make space available for future cables.

The formula for calculating the proper cable tray design load for the 36" wide cable tray is:

- $(59.22 \text{ lbs/ft} \times 36 \text{ inches}) / 30 \text{ inches} = \mathbf{71.06 \text{ lbs/ft}}$.

If this cable tray is installed indoors, a load symbol "B" cable tray would be adequate. However, if there are additional loads on the cable tray or the cable tray were installed outdoors, it would be necessary to calculate all the additional potential loads.

Additional potential load types

Most cable trays are utilized as continuous beams with distributed and concentrated loads. Cable trays can be subjected to static loads like cable weight and dynamic loads such as snow, ice and wind. And if the cable tray has space available for future cable additions, a cable tray capable of supporting the final future load must be selected and specified.

The total load for the cable tray is determined by adding all the applicable component loads.

Total load =

- cable load +
- any concentrated loads (if applicable) +
- ice load (if applicable) +
- snow load (if applicable) +
- wind load (if applicable) +
- other special condition loads (i.e. future cabling)

Concentrated static loads

A concentrated static load represents a static weight applied at a single point between the side rails. When applied at the midspan, a concentrated load is one of the most stressful conditions a cable tray will experience.

Tap boxes, conduit attachments and long cable drops are examples of concentrated loads. When so specified, concentrated static loads may be converted to an equivalent, distributed load by using the following formula:

$$\text{Uniform load} = \frac{2 \times (\text{concentrated static load})}{\text{span length}}$$

Cable tray is not a walkway!

B-Line series cable tray side rails, rungs and bottoms will withstand a 200 lb. static load without collapse.

However, it should be noted that per NEMA Standard Publication VE1, cable tray is designed as a support for power and/or control cables, and is not intended or designed to be a walkway for personnel.

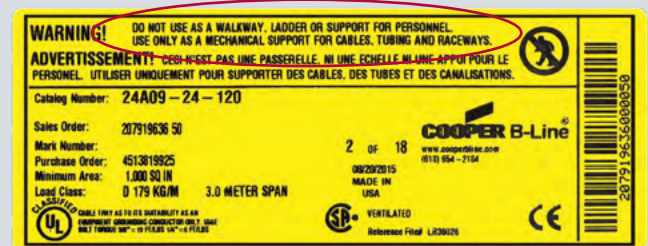

Ice loads

Outdoor cable tray installations may be subjected to ice and snow loading. Glaze ice is the most common form of ice build-up. It is the result of rain or drizzle freezing on impact with an exposed object.

The maximum design load to be added due to ice should be calculated as follows:

$$LI = \left(\frac{W \times TI}{144} \right) \times DI$$

- LI = Ice Load (lbs/linear foot)
- W = Cable Tray Width (inches)
- TI = Maximum Ice Thickness (inches)
- DI = Ice Density = 57 lbs/ft³

Maximum ice thickness will vary depending on location. A thickness of 1/2" can be used as a conservative standard



Ice load calculation example:

24" wide cable tray with 1/2" thick ice

$$\left(\frac{24 \times 0.5}{144} \right) \times 57 = 4.75 \text{ lbs/ft}$$

Snow loads

Snow load is measured by density and thickness, and it can be significant for a cable tray that is completely full of cables or a cable tray that has covers. The density of snow varies greatly due to its moisture content, however the minimum density that should be used for snow is 5 pounds per cubic foot. The engineer or designer will have to contact the weather service local to the project site to determine the potential snow falls for the installation area, or consult the local building code for a recommended design load.

Wind loads

Wind loads need to be determined for all outdoor cable tray installations. Most outdoor cable tray systems are ladder type tray, and the most severe wind loading will be the impact pressure to the cable tray side rails. The generic impact pressures corresponding to various wind velocities are provided in the table to the right.

Generic impact pressure from wind

Wind velocity (mph)	Impact pressure	Wind velocity (mph)	Impact pressure
15	0.58	85	18.5
20	1.02	90	20.7
25	1.60	95	23.1
30	2.30	100	25.6
35	3.13	105	28.2
40	4.09	110	30.9
45	5.18	115	33.8
50	6.39	120	36.8
55	7.73	125	40.0
60	9.21	130	43.3
65	10.80	135	46.6
70	12.50	140	50.1
75	14.40	145	53.8
80	16.40	150	57.6

To fully understand how wind affects your next project, contact blinetechsupport@eaton.com

When covers are installed on outdoor cable trays, another factor to be considered is the aerodynamic effect which can produce a lift strong enough to separate a cover from a tray.

Wind moving across a covered tray creates a positive pressure inside the tray and a negative pressure above the cover. This pressure difference can lift the cover off the tray.

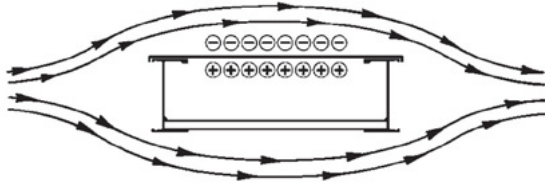

Covers which fly off the cable tray create a serious hazard to personnel. During high winds, light duty clips are not capable of restraining the covers. Outdoor cover installations should be overlapped at expansion joint locations to eliminate cover buckling, and we recommend the use of heavy duty wraparound covers and cover clamps.

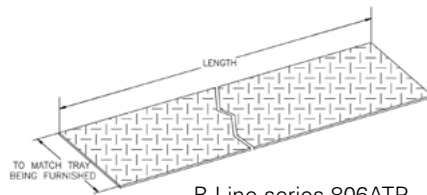

B-Line series 806ATP
Aluminum Tread Cable Tray Cover



Cable tray damage due to high winds

Eaton can provide a certified wind calculation report for your installation - *at no additional cost*

Our Engineering Services team will work with you to verify that the cable tray designs from the electrical engineer and structural engineer are feasible for high wind locations. Our wind certification report provides you with list of acceptable B-Line series cable tray supports, fittings and covers based off of the environmental conditions, cable loading, and type of cable tray in your installation.

We'll also provide design recommendations that minimize the required number of cable ladder supports in your installation, helping you reduce costs without sacrificing safety or reliability.

For more information, please contact blinetechsupport@eaton.com



Installation loads

The potential load most often ignored is installation loads. The stresses of pulling large cables through cable trays can produce 3 times the stress of the cables' static load. If the installation load is not evaluated the cable tray may be damaged during installation. A 16C or 20C NEMA Class should be specified if large cables are to be pulled, and always follow NEMA VE 2 cable pulling guidelines.

The differences between NEC & IEC cable tray



In the United States, cable tray requires NEC compliance, while Canada requires CSA compliance. The rest of the globe requires IEC compliance for cable tray. It is always important to know the region where the cable tray is being installed, in order to understand the codes and standards that the product must meet.

For example, a project could be designed by an engineer in the United States, but the installation could be in Asia. Therefore, the cable tray would need to meet IEC compliances, not NEC.

The National Electrical Manufacturer Association (NEMA) and International Electrotechnical Commission (IEC) both provide technical requirements regarding the construction, testing, and performance of metallic cable tray systems. However, testing methods differ drastically, showing different performance results.

Load Classes - NEC vs. IEC

NEMA load classes clearly define the strength of a straight section of cable tray. As mentioned earlier in the “Cable Tray Strength & Load Capacity” section of this guide, NEMA load classes are defined in the VE-1 Manufacturing Standard by using a combination of a number and a letter.

- The number defines the **span** of the cable tray in feet between supports
- The letter defines the cable tray **load** in pounds per foot

Unlike NEMA, IEC does not list load classes. Instead the cable tray strength may be described in several ways on an IEC project specification.

	Cable tray strength descriptions on IEC specs
Ideal	Specification states the actual load and span for the cable tray application. For example, 140 kg per meter on a 6 meter span.
Acceptable	Specification calls out a required gauge or thickness of the tray material
Unclear	Specification makes a generic comment of “heavy duty” or “medium duty”

The second and the third description may be listed on a specification, but are not as clear and are open to interpretation. In this situation, it would be best to contact the project specifier to gain additional information.



Choosing a cable tray manufacturer with proven success in both NEC and IEC standards, such as Eaton, is crucial to help ensure proper system design.

Eaton’s B-Line series cable tray solutions are fully compliant with both NEMA and IEC load and electrical continuity certifications.

Load Testing - NEC vs. IEC

NEMA VE-1 cable tray load tests are set up and conducted one specific way, using a single beam that is tested to destruction. IEC allows for five different test set-ups, which utilize continuous spans of tray and are deflection-based.

NEC (NEMA VE-1) load test:

1. One cable tray span is set up with supports at each end.
2. No splices are used, and neither end of the tray is clamped down.
3. The cable tray span is then loaded with weights **until it physically fails** to support the weight.
4. If it meets or exceeds the NEMA load requirement for the specific span prior to failure, the cable tray will pass NEMA testing and it will be given a specific NEMA load classification.

Note - A 1.5 safety factor (SF) is applied to the failure load weight to determine the catalog load.

Example: If the catalog load says 100lbs with a 1.5 SF, this means it will physically fail at 150lbs.



NEMA load test - Worse cast load scenario -
Single span with weight applied until physical failure

IEC load testing:

1. A continuous span of cable tray is set up with supports
2. Splice plates are used to connect the multiple pieces of ladder
3. The continuous span is then loaded with weights **until deflection of 1/100 of the span** is reached. This is considered failure.

Note - A 1.7 safety factor (SF) is applied to the failure load weight to determine the catalog load.

Example: If the catalog load says 100lbs with a 1.7 SF, this means the cable tray will deflect to 1/100 of the span length at 170lbs.

It can be difficult to compare published IEC load ratings because the specifics of the testing method can vary and are not always published with the load rating.



IEC load test - Typical installation scenario
Continuous span with weight applied until deflection reaches 1/100 of span length

	NEMA	IEC
Test set up options	1	5
Destructive load test	Yes	No
Deflection load test	No	Yes
Splice plates part of test	No	Yes
Support recommendations	Yes	No
Additional impact testing	No	Yes

Key Takeaway

NEMA = Load based
IEC = Deflection based

IEC load testing requires 3rd party witness verification (such as DNV). While this is not required for NEMA load testing, 3rd party verification (such as CSA or DNV) is a common practice among top cable tray manufacturers.

Understanding thermal contraction & expansion



Thermal contraction and expansion

All materials expand and contract due to temperature changes. Cable tray installations should incorporate features like expansion splice plates, which adequately compensate for this. Understanding where and how often to allow for thermal expansion and contraction is an essential measurement to the longevity of a cable tray system. Cable tray system designs that do NOT take this into consideration will likely experience reduced performance and possibly system failure.

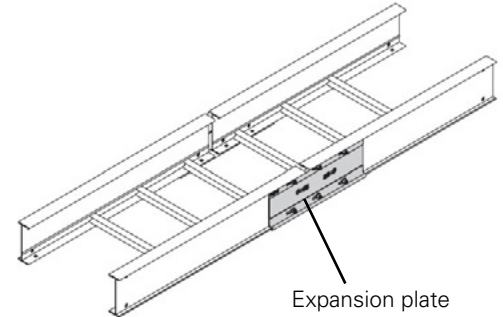

Section 3.4.2 of [NEMA VE 2-2018 Standard for Cable Tray Installation Guidelines](#) addresses cable tray expansion and provides guidance on determining the gap setting between tray sections, as well as the number of expansion plates required in a tray system.

Expansion & contraction is the #1 issue leading to pre-mature failure in the cable tray system

Determining the correct gap for installation of expansion splice plates

Accurate gap setting at the time of cable tray installation is necessary for the proper operation of the expansion splice plates. The expansion gap between two pieces of cable tray should be set based on the *total temperature differential* with respect to the temperature at time of installation.

The calculation example below is from Section 3.4.2 of NEMA VE 2-2018 publication:

Step 1. Using Figure 3-40, plot the highest expected cable tray metal temperature during the year on the maximum temperature vertical axis. *Example value: 100°F (38°C).*

Step 2. Plot the lowest expected cable tray metal temperature during the year on the minimum temperature vertical axis. *Example value: -28°F (-33°C).*

Step 3. Draw a line between these maximum and minimum temperature points.

Step 4. Plot the cable tray metal temperature at the time of the cable tray installation on the maximum temperature vertical axis. *Example value: 50°F (10°C)*

Project right until you intersect with the line drawn between the maximum and minimum cable tray metal temperatures.

From this intersection point, project down to the gap setting horizontal axis to find the correct gap setting.

Example value: 3/8 inch gap setting

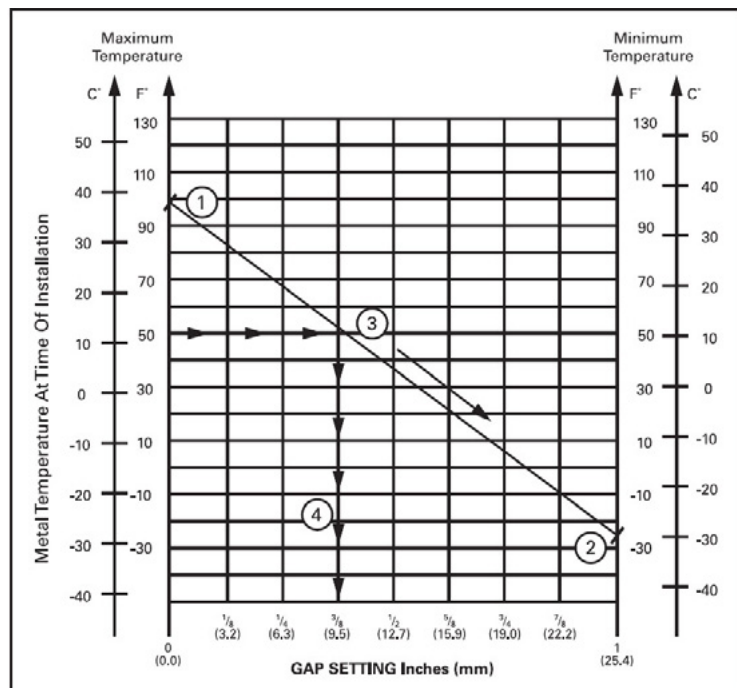

Figure 3-40 Gap Setting of Expansion Splice Plate - 25.4 mm (1 in) Gap Maximum

This is the length of the gap to be set between the cable tray sections at all expansion joints.

Determining the maximum spacing between expansion joints

First calculate the application's temperature differential, which is the difference between the hottest and coldest days of the year. Then use the closest differential value in NEMA VE-2 Table 3-2 to determine the maximum spacing for the cable tray material being used.

In the example on the previous page, the temperature differential would be 128°F (-28°F to 100°F).

The 125°F row in Table 3-2 indicates that the installation would require 3/8" expansion plates approximately every 102-feet for steel, 52-feet for aluminum, and 133-feet for fiberglass cable tray.

Temperature Differential*		Steel		Aluminum		Fiberglass	
°C	(°F)	m	(ft.)	m	(ft.)	m	(ft.)
14	(25)	156	(512)	79	(260)	203	(667)
28	(50)	78	(256)	40	(130)	102	(333)
42	(75)	52	(171)	27	(87)	68	(222)
56	(100)	39	(128)	20	(65)	51	(167)
70	(125)	31	(102)	16	(52)	41	(133)
83	(150)	26	(85)	13	(43)	34	(111)
97	(175)	22	(73)	11	(37)	29	(95)

*Temperature differential is the difference in temperature between the hottest and coldest days of the year.
 **For designs that provide for 16 mm (5/8 in) movement (typically non-metallic), multiply maximum spacing between expansion joints by 0.625.

Table 3-2 Maximum Spacing between Expansion Joints the Provide for 250mm (1 in.) Movement**



Our Heavy Duty expansion plates can eliminate additional support requirements, lowering your installation costs

[B-Line series Heavy Duty Expansion Slice Plates](#) are engineered to eliminate the NEMA recommended additional supports at each expansion joint where expansion splice plates are utilized.

Traditional expansion splices require the installation of two supports, one on either side of the expansion splice. By utilizing our Heavy Duty Expansion Splice Plate, no additional supports are required when the splice is placed at quarter span. And our thermal gap window simplifies gap setting during installation!

Hold down clamps and expansion guide clamps

The correct use of hold down clamps and expansion guide clamps to anchor the cable tray to its supports is a final critical element in the operation of expansion splices. The cable tray must not be clamped to each support so firmly that it cannot contract and expand without distortion.

- Cable tray should be anchored with hold down clamps at the support closest to the midpoint between the expansion plates
- Cable tray should be secured with expansion guide clamps at all other support locations

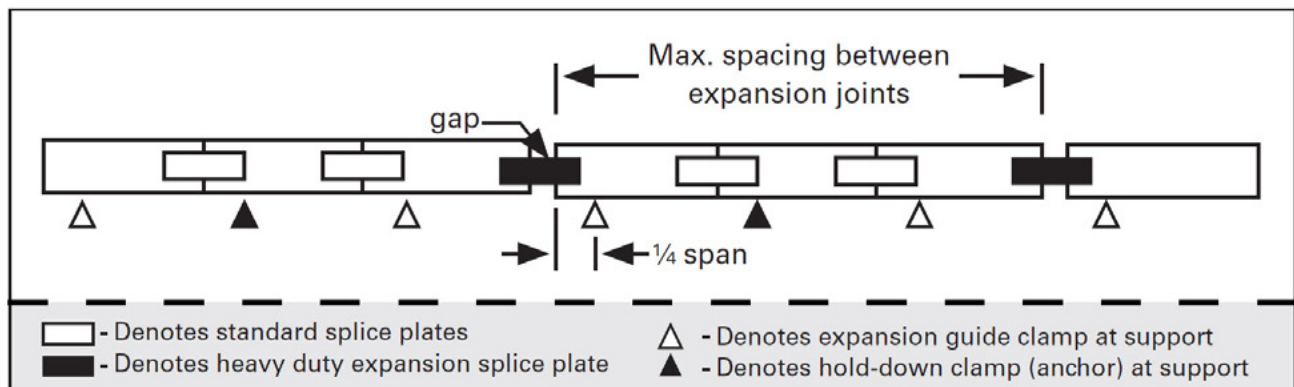

Cable tray materials & applications



Selecting the proper material for your environment can mean the difference between a trouble-free cable tray system and costly equipment failure. Designed for a variety of environments from light commercial to heavy industrial, Eaton offers NEMA and IEC cable support systems in aluminum, pre-galvanized steel, hot dip galvanized steel, stainless steel and fiberglass. Read below to learn more about each of our material's characteristics and performance across applications.



Aluminum cable tray

Typically, aluminum cable tray can perform indefinitely, with little to no degradation over time, making it ideal for most installations unless specific corrosion problems prohibit its use. B-Line series aluminum cable tray is fabricated from structural grade, copper-free aluminum alloy 6036-T6.

Application Suitability	
Indoor	●
Outdoor - Non-saline	●
Outdoor - Saline	●
Acids / Chlorines	●

Performance Data	
Max .Temperature	93°C / 200°F
Min. Temperature	-129°C / -200°F
Strength-to-Weight Ratio	●
Electrical Conductivity	●
Thermal expansion/contraction	●

Aluminum cable tray has an excellent strength-to-weight ratio, making it easy to install & field modify. On average, aluminum cable tray weighs just 60% of its steel equivalent, but it is capable of carrying heavier loads than steel cable tray. Aluminum's light weight significantly reduces the cost of installation when compared to steel.

Aluminum has excellent resistance to "weathering" in most outdoor applications. Aluminum may experience some pitting in a marine environment, but this will not affect the structural integrity of the system.

Aluminum cable tray has excellent corrosion resistance in many chemical environments, and has been used reliably for decades in petro-chemical plants and paper plants throughout North America. Aluminum's corrosion resistance is due to its ability to form an aluminum oxide film that when scratched or cut reforms the original protective film.



96 hours exposure



240 hours exposure



504 hours exposure



1032 hours exposure

ASTM A123 Salt Spray Test Results - Aluminum cable tray *

Aluminum cable tray is also optimal for equipment grounding conductors (EGC) and is adequate for circuits with ground-fault protection up to 2000 amperes.

* ASTM A123 Salt Spray Test is a standardized and popular corrosion test method, used to check corrosion resistance of materials and surface coatings.

Accounting for thermal expansion and contraction with aluminum cable tray

Compared to the other materials, aluminum cable tray does have a higher rate of expansion and contraction due to temperature changes (refer to *Understanding thermal contraction & expansion* section in this guide).

Including expansion splice plates into your cable tray system design is essential for compensating for this thermal movement. Expansion plates allow for one inch of expansion or contraction of the cable tray, or where expansion joints occur in the structure.

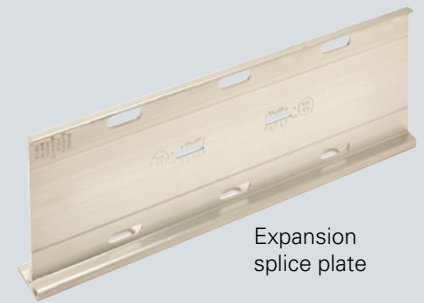

Expansion splice plate



Steel cable tray with hot dip galvanized finish

Our hot dip galvanized (HDG) steel cable tray is well-suited for applications in indoor and outdoor, non-saline environments.

Application Suitability	
Indoor	●
Outdoor - Non-saline	●
Outdoor - Saline	●
Acids / Chlorines	●

Performance Data	
Max .Temperature	260°C / 500°F
Min. Temperature	-29°C / -20°F
Strength-to-Weight Ratio	●
Electrical Conductivity	●
Thermal expansion/contraction	●

After fabrication, the steel tray is immersed into a bath of molten zinc, completely coating all surfaces, including edges and welds. This layer of zinc bonds to the steel, providing added protection against corrosion. The thicker the coating of HDG, the longer the lifespan of the cable tray. [Eaton's B-Line series cable tray is coated to ASTM 123 standard with 1.5 oz./sq. ft. on each side.](#)

Hot dip galvanized steel cable tray will perform well in many outdoor environments, but it is not acceptable for use in saline environments.

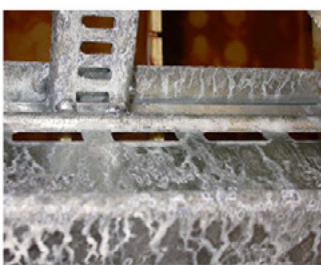

24 hours exposure



96 hours exposure



240 hours exposure



504 hours exposure

ASTM A123 Salt Spray Test Results - Steel Hot Dip Galvanized Finish cable tray *

Installing cable tray in a marine/offshore application? Check out our B-Line series Marine Rung

Features a special rung design with .438" x .720" slots to accommodate the stainless steel banding of cables (Coast Guard requirement). Marine rung also works well for applications on land where extra cable positioning/attachment is required.

Available in aluminum, HDGAF steel and stainless steel.

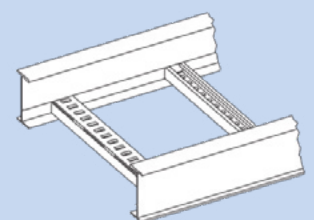



Stainless steel cable tray

B-Line series Stainless steel cable tray is fabricated from continuous roll-formed American Iron and Steel Institute (AISI) type 304, 316 or 316L stainless steel.

Application Suitability	
Indoor	●
Outdoor - Non-saline	●
Outdoor - Saline	●
Acids / Chlorines	●

Performance Data	
Max .Temperature	426°C / 800°F
Min. Temperature	-184°C / -300°F
Strength-to-Weight Ratio	●
Electrical Conductivity	●
Thermal expansion/contraction	●

Stainless steel is the best material choice for extreme indoor and outdoor conditions, and it has the highest maximum and lowest minimum operating temperatures of all the materials. Several design requirements that could make stainless steel an ideal choice for a cable tray installation include corrosion resistance, reduced long term maintenance costs, appearance and locations where product contamination is undesirable.

ASTM A123 Salt spray tests show that even after 1032 hours of exposure, stainless steel has little, if any, corrosion. Both 304 and 316 are acceptable for any environment, although 316 SS is recommended for environments with acids or chlorines.

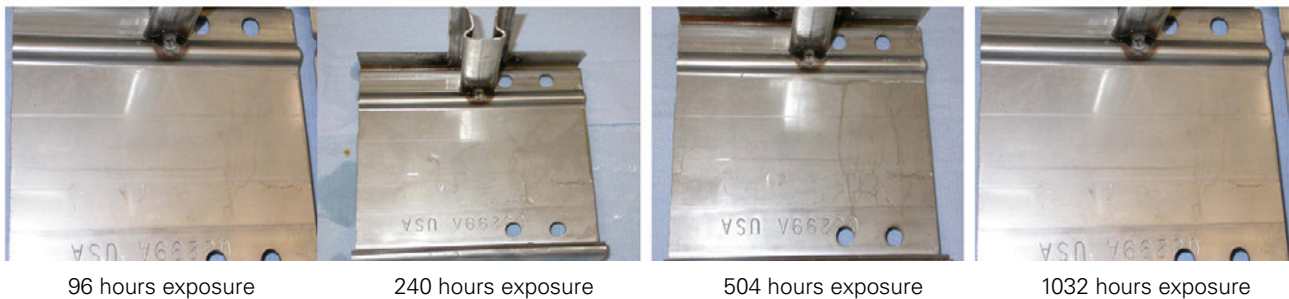

ASTM A123 Salt Spray Test Results - Stainless steel cable tray





Fiberglass cable tray

Fiberglass cable tray is used in the most severe corrosive and harsh environments. It's mostly used in oil & gas and chemical applications, but it is acceptable for any environment due to its strong overall properties.

Application Suitability	
Indoor	●
Outdoor - Non-saline	●
Outdoor - Saline	●
Acids / Chlorines	●

Performance Data	
Max .Temperature	49°C / 120°F
Min. Temperature	-73°C / -100°F
Strength-to-Weight Ratio	●
Electrical Conductivity	●
Thermal expansion/contraction	●

ASTM A123 Salt spray tests show that after 1032 hours of exposure, fiberglass cable tray shows no corrosion.

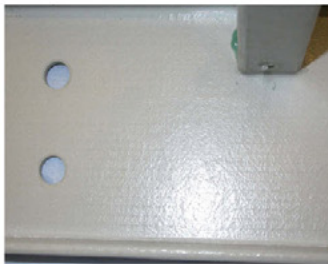

96 hours exposure



240 hours exposure

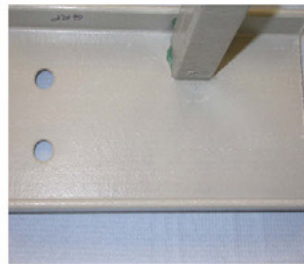

504 hours exposure



1032 hours exposure

Vinyl Ester Salt Spray Test Results - Fiberglass cable tray

B-Lines series fiberglass cable tray is manufactured from glass fiber-reinforced plastic that meets ASTM E-84, smoke density ratings for polyester of 680, for vinyl ester 1025, class 1 flame rating, and self extinguishing requirements of ASTM D-635. A surface veil is applied during pultrusion to ensure a resin-rich surface and ultraviolet resistance.

Additional features of B-Line series fiberglass cable tray:

- Lighter weight than steel and stainless steel
- Fire resistant and self-extinguishing when fire source is eliminated – conforms to ASTM-84 Class 1 and UL 94 VO
- Three levels of UV protection – 10 mil veil of polyester or vinyl ether / UV inhibitors in the matrix / UV inhibitors in the pigment
- No need to seal after cutting – over time, fiberglass takes the properties of the environment, negating benefits of sealing



B-Line series fiberglass cable tray is available in two different finishes to meet your application-specific needs

- **F:** Gray fire-retardant polyester. Good corrosion resistance in most environments
- **FV:** Beige fire-retardant vinyl ester, designed for more severe environments. Has a higher heat distortion temperature.

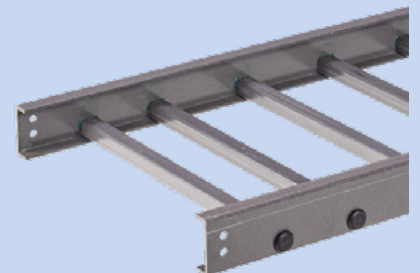

Cable tray corrosion factors



All metal surfaces in a cable tray system will be affected by corrosion over time. The type of corrosion, as well as its severity, depends on the physical properties of the metals used and the environment to which the cable tray is exposed.

Galvanic corrosion

Galvanic corrosion occurs when two or more dissimilar metals are in contact while in the presence of an electrolyte (ie. moisture). An electrolytic cell is created, and the dissimilar metals form an anode or a cathode depending on their relative position on the Galvanic Series Table. The anodic material will be the one to corrode. Whether a material is anodic depends on its relative position to the other material on the galvanic series table.

For example: If zinc and steel are in contact, the zinc acts as the anode and will corrode over time; the steel acts as the cathode and will be protected. If steel and copper are in contact, the steel is now the anode and will corrode.

The rate at which galvanic corrosion occurs depends on several factors:

1. The amount and concentration of electrolyte present - An indoor, dry environment will have little or no galvanic corrosion compared to a consistently wet atmosphere.
2. The relative size of the materials - A small amount of anodic material in contact with a large amount of cathodic material will result in greater corrosion. Conversely, a large anode in contact with a small cathode will decrease the rate of attack.
3. The relative position of the two metals on the Galvanic Series Table – The further apart in the Galvanic Series Table, the greater the potential for corrosion of the anodic material.

Galvanic Series Table

Anodic End	
Magnesium	
Magnesium Alloys	
Zinc	
Beryllium	
Aluminum - Zinc Alloys (7000 series)	
Aluminum - Magnesium Alloys (5000 series)	
Aluminum (1000 series)	
Aluminum - Magnesium Alloys (3000 series)	
Aluminum - Magnesium - Silicon Alloys (6000 series)	
Cadmium	
Aluminum - Copper Alloys (2000 series)	
Cast Iron, Wrought Iron, Mild Steel	
Austenitic Nickel Cast Iron	
Type 410 Stainless Steel (active)	
Type 316 Stainless Steel (active)	
Type 304 Stainless Steel (active)	
Naval Brass, Yellow Brass, Red Brass	
Tin	
Copper	
Lead-Tin Solders	
Admiralty Brass, Aluminum Brass	
Manganoso Bronzo	
Silicon Bronzo	
Tin Bronzo	
Type 410 Stainless Steel (passive)	
Nickel - Silver	
Copper Nickel Alloys	
Lead	
Nickel - Aluminum Bronze	
Silver Solder	
Nickel 200	
Silver	
Type 316 Stainless Steel (passive)	
Type 304 Stainless Steel (passive)	
Incoloy 825	
Hastelloy B	
Titanium	
Hastelloy C	
Platinum	
Graphite	
Cathodic End	

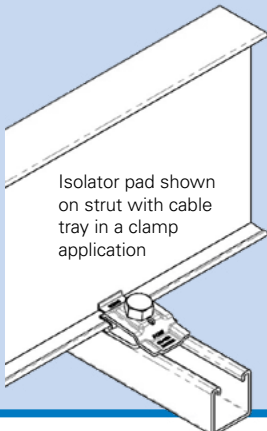

Isolator pad shown on strut with cable tray in a clamp application

Worried about galvanic corrosion? Eaton has you covered!

Our **B-Line series Isolator Pads** create a barrier between two dissimilar metals. The isolator pads are ideal for use in applications with aluminum cable tray and steel supports, where structural integrity loss due to galvanic corrosion is a concern.

Manufactured from UV resistant, high density polyethylene, and designed to seamlessly integrate with B-line series multi-purpose guide clamps.

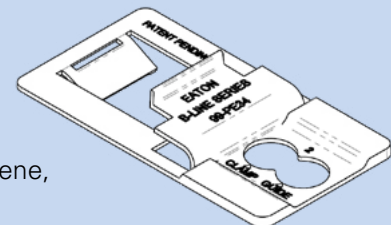

Atmospheric corrosion

Atmospheric corrosion occurs when metal is exposed to airborne liquids, solids or gases. Some sources of atmospheric corrosion are moisture, salt, dirt and sulfuric acid. This form of corrosion is typically worse outdoors, especially near marine environments.

Chemical corrosion

Chemical corrosion takes place when metal comes in direct contact with a corrosive solution. Some factors which affect the severity of chemical corrosion include:

- Chemical concentration level
- Duration of contact
- Frequency of washing
- Operating temperature



Chemical and atmospheric corrosion on a cable tray installation at a paper mill

Eaton can help you select the right material for your cable tray system

B-Line series cable tray is available in a variety of materials and finishes to maximize performance and service life in any environment. Our Engineering Services team will work with you to ensure you're using the optimal material for your application.

Material	Suitable Environments	Advantages
Steel ASTM A1011 ASTM A1008 ASTM A653SS ASTM A510 (Flextray)	Indoor (pre-galvanized) Indoor / Outdoor, non-saline (hot dip galvanized)	<ul style="list-style-type: none"> • Low thermal expansion/contraction
Aluminum 6063-T6	Indoor / Outdoor	<ul style="list-style-type: none"> • Copper-free, marine grade • Easy installation & field modifications • Excellent strength-to-weight ratio • Excellent grounding conductor
Stainless Steel AISI Type 304 AISI Type 316/316L ASTM A240	Indoor / Outdoor	<ul style="list-style-type: none"> • Excellent corrosion resistance • Withstands temperature extremes • 316 SS a good choice for acids/chlorines • High aesthetics - low contamination
Fiberglass	Indoor / Outdoor	<ul style="list-style-type: none"> • Highest level of corrosion resistance • Lowest thermal expansion/contraction • Lower weight than steel and stainless

For more detailed information on how our cable tray materials perform against specific chemicals at various temperatures, our chemical corrosion guide is available at eaton.com/ct-corrosion-guide

Chemical	Corrosion Guide								
	Cable Tray Material								
	Aluminum			Stainless Type 304			Stainless Type 316		
	Cold	Warm	Hot	Cold	Warm	Hot	Cold	Warm	Hot
Lactic Acid 10%	R	F	NR	R	R	F	R	R	R
Lead Acetate 5%	NR	NR	NR	R	R	R	R	R	R
Magnesium Chloride 1%	NR	NR	NR	R	-	F	R	-	R
Magnesium Hydroxide	R	R	R	R	R	-	R	R	-
Magnesium Nitrate 5%	R	-	-	R	R	R	R	R	R
Nickel Chloride	NR	NR	NR	R	-	-	R	-	-
Nitric Acid 15%	NR	NR	NR	R	R	R	R	R	R
Oleic Acid	R	R	F	R	R	F	R	R	R
Oxalic Acid 10%	R	F	NR	NR	NR	NR	R	R	R

Cable ladder use in extreme temperatures



Aluminum, steel, stainless steel and fiberglass are all readily available materials for cable tray manufacturing. These materials perform very well at ambient temperatures (0°F to 100°F). However, once the confines of these temperatures have been exceeded, the materials start to react differently. For example, cable tray located over a boiler or in close proximity to a large furnace can be subjected to some dangerously high temperatures.

A good understanding of how materials perform at extreme temperatures is critical to avoiding expensive downtime and serious injuries.

Selecting the right materials for cable tray use at high temperatures

As temperatures rise, a material's tensile strength decreases. In other words, it becomes weaker, less stiff, and more ductile. In terms of reliability, the materials are listed below in order of *least effective to most effective* for cable tray in high temperatures.

Fiberglass – This material is the least effective at dealing with heat. Fiberglass cable tray loses 10% of its rated strength at temperatures as low as 100°F. At 200°F, fiberglass will lose up to 50% of its rated load. The use of additional supports is necessary to offset the decrease in material strength at temperatures above 100°F.

Aluminum – Aluminum exhibits better performance than fiberglass under elevated temperatures. Based on the tensile strength of 6063-T6 aluminum alloy, aluminum loses only 9% of its strength at 200°F, while more than a third of its strength is lost by the time the temperature reaches 300°F.

Steel – Low-carbon steel easily outperforms both fiberglass and aluminum in extremely hot environments. Standard steel tray will perform well with very little change in strength in temperatures up to 600°F.

Stainless steel – The most effective material for dealing with high temperatures. Stainless steel exhibits greater strength at 800°F than low-carbon steel displays at room temperature.

Material	Maximum continuous recommended temperature
Fiberglass	90-120°F (32-49°C)
Aluminum	180-200°F (82-93°C)
Low-Carbon Steel	400-500°F (204-260°C)
Stainless Steel	800°F (427°C)

Can your cables take the heat?

The highest continuous temperature rating for 600V building wire is 90°C (194°F). Specialty cable such as Teflon® insulated nickel-coated wire can be rated up to 500°F.

Be sure your design factors in the temperature limitations of the cables being supported in the tray system.

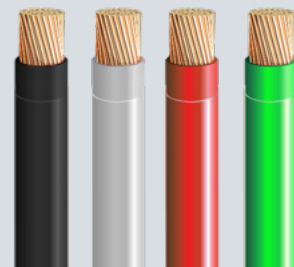

Selecting the right materials for cable tray use at low temperatures

As temperatures decrease, a material's tensile strength typically increases, while its elongation typically decreases. This means the material becomes stronger but less ductile (flexible). In terms of reliability, the materials are listed below in order of *least effective to most effective* for cable tray in low temperatures.

Steel - Low-carbon steel will lose ductility slowly as temperatures decrease. At a certain point, the ductility will rapidly decrease by over 50% within a very small temperature range. This point is called the **ductile-to-brittle transition** and occurs in all unalloyed, low-carbon steel. Depending on the quality of the steel, this transition can occur anywhere from +32°F to -40°F (0 to -40°C).

Steel cable tray installations subjected to low temperatures must be over-designed by 20 to 50% to compensate for the decreased ductility, especially on long spans. This adds substantial weight and expense to an already heavy system. If steel cable tray is not subject to impact loads or vibration, it may perform fine at low temperatures, but it can be very difficult to control this kind of dynamic loading in the field.

Material	Minimum continuous recommended temperature
Low-Carbon Steel	-20°F (-29°C)
Fiberglass	-100°F (-73°C)
Aluminum	-200°F (-129°C)
Stainless Steel	-300°F (-184°C)

Design recommendation - Due to the ductile-to-brittle transition phenomenon, it is our recommendation that low-carbon steel clamps not be used below 0°F (-18°C) where impact loads may be present. Instead, stainless steel clamps should be used.

Fiberglass – Although fiberglass does become less ductile as temperatures decrease, it does not exhibit a ductile-to-brittle transition period as low-carbon steel does. Because of this, fiberglass cable tray in cold climates only requires a minor (10%) increase in design strength, making it a much better choice.

Aluminum – Aluminum cable trays have a distinct strength advantage over low-carbon steel cable tray in very cold environments. At -121°F aluminum exhibits a 6% increase in yield strength with a 1% increase in elongation. This is a much greater flexibility over low-carbon steel with no ductile-to-brittle transition.

Stainless steel – Just as with high temperatures, stainless steel is the most effective material for dealing with low temperatures. At -320°F, AISI type 304 and 316 stainless steels gain approximately 9% of their room temperature yield strength with a 46% decrease in elongation. Stainless steel (type 304 or 316) does not exhibit any ductile-to-brittle transition at low temperatures (even down to -400°F), and is an excellent material for frigid temperatures.

Cable tray covers

Cable tray covers provide protection for cables in the tray system from mechanical damage, falling objects, environmental damage and prolonged sunlight. The most serious hazard to cable in cable trays is when the cables are exposed to significant amounts of hot metal spatter during construction or maintenance from torch cutting of metal and welding activities. For these exposure areas, the cable tray should be temporarily covered with plywood sheets.

If such exposure is to be a frequent occurrence, cable tray covers should be installed in the potential exposure areas. Where cable trays contain power and lighting conductors, ventilated covers are preferable to solid covers since the ventilated covers allow the cable heat to be vented from the cable tray.

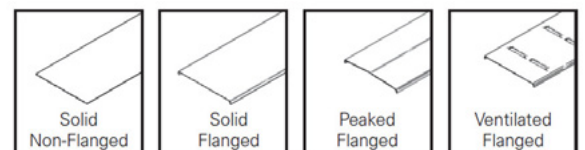

Cable tray cover types

When covers are required to be installed outdoors, they should be overlapped at expansion joint locations to eliminate cover buckling. Additionally, the covers should be attached to the cable trays with heavy duty wrap around clamps instead of standard duty clips. During high winds, the light duty clips are not capable of restraining the covers. Covers which fly off the cable tray create a serious hazard to personnel and equipment.

Determining cable tray width requirements

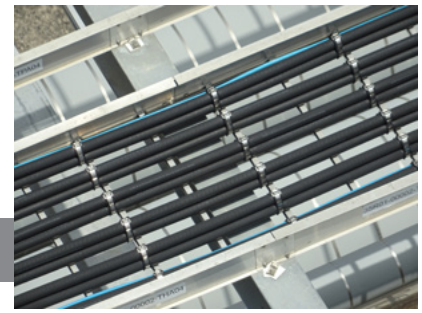

Industrial and commercial cable tray is typically available in widths of 6 to 36 inches (150-900 mm). The type and size of the cables used will determine the required cable tray width. See the guidelines below, which are based off of the National Electrical Code, Article 392.

Width selection for cable tray containing **multiple-conductor** cables rated 2000 volts or less

#4/0 AWG or larger cables:

For ladder or ventilated trough trays, the diameter of all cables 4/0 and larger must be added together, and *the total must not exceed the inside width of the cable tray*. Cable installation is limited to a single layer (side by side placement).

When using solid bottom cable tray, the sum of the 4/0 and larger cable diameters may not to exceed 90% of the available inside cable tray width.

Width calculation example - 4/0 or larger cables:

	List cable sizes	List Cable Outside Diameter (D)	List Number of Cables (N)	Sum of the Cable Diameters Multiply (D) x (N)
1	3/C - #500 kcmil	2.26 inches	4	9.04 inches
2	3/C - #250 kcmil	1.76 inches	3	5.28 inches
3	3/C - #4/0 AWG	1.55 inches	10	15.50 inches
Total Sum of the Cable Diameters (SD) for all cables				29.82 inches

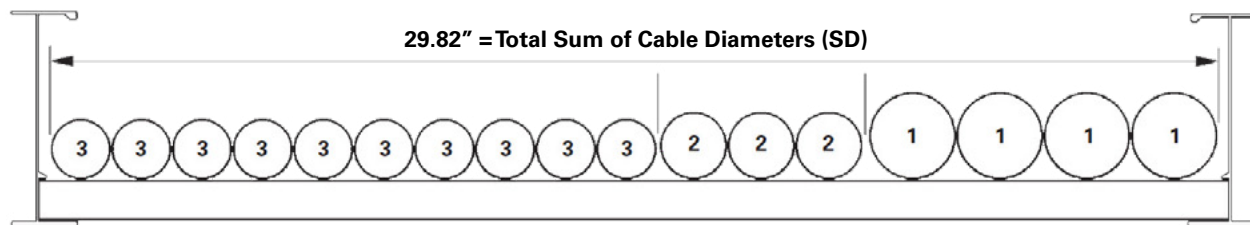

The ladder cable tray must have an inside available width equal to or greater than the sum of the diameters. Since the sum of the diameters of all cables is 29.82, **a cable tray with an inside width of 30 inches is required.**

Important consideration - Design with the future in mind

When determining cable tray width requirements, we recommend planning for system expansion and oversizing the tray to allow for future additions. For a 10% increase in cost a 36 inch wide cable tray could be purchased, which would provide for future cable additions with no re-design costs.

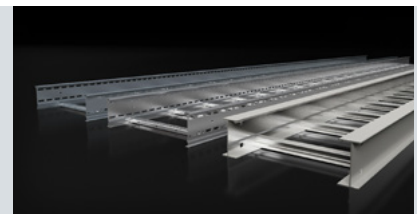

Cables smaller than #4/0 AWG:

For ladder or ventilated trough trays, the total sum of the cross-sectional areas of all the cables to be installed in the cable tray *must be equal to or less than the allowable cable area for the tray width*, as indicated in the table to the right.

These cables do not have to be placed side by side.

When using solid bottom cable tray, the allowable cable area is reduced by 22%.

Inside Width of Cable Tray (inches)	Allowable Cable Area (square inches)
6.0	7.0
9.0	10.5
12.0	14.0
18.0	21.0
24.0	28.0
30.0	35.0
36.0	42.0

Width calculation example - cables smaller than 4/0:

	List cable sizes	List Cable Cross Sectional Areas (A)	List Number of Cables (N)	Total Cross Sectional Area Multiply (A) x (N)
○	3/C #12 AWG	0.17 sq. in.	20	3.40 sq. in.
●	4/C #12 AWG	0.19 sq. in.	16	3.04 sq. in.
▨	3/C #6 AWG	0.43 sq. in.	14	6.02 sq. in.
▩	3/C #2 AWG	0.80 sq. in.	20	16.00 sq. in.
Sum of Total Areas for all cables				28.46 sq. inches

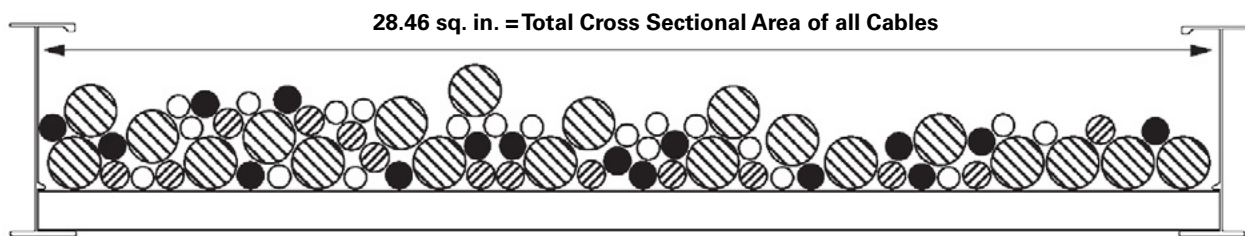

Referencing the table above, which is part of Table 392.9 from the National Electrical Code, **a 30-inch cable tray with an allowable cable fill area of 35 sq. in. must be used.** This 30-inch cable tray has the capacity for 6.54 sq. in. of additional future cables (35.0-28.46).

#4/0 AWG or larger cables and cables smaller than #4/0 AWG:

The ladder cable tray needs to be divided into two zones so that the No. 4/0 and larger cables have a dedicated area, as they must be placed in a single layer. A barrier or divider is not required, but one can be used if desired.

Width calculation example - cables larger and smaller than 4/0:

First, determine the width required for the #4/0 AWG and larger multi-conductor cables.

	List cable sizes	List Cable Outside Diameter (D)	List Number of Cables (N)	Sum of the Cable Diameters Multiply (D) x (N)
1	3/C - #500 kcmil	2.26 inches	3	6.78 inches
2	3/C - #4/0 AWG	1.55 inches	4	6.20 inches
Total Sum of the Cable Diameters (SD) for all cables				12.98 inches

Second, determine the width required for the #3/0 AWG and smaller multi-conductor cables.

	List cable sizes	List Cable Cross Sectional Areas (A)	List Number of Cables (N)	Total Cross Sectional Area Multiply (A) x (N)
○	3/C #12 AWG	0.17 sq. in.	20	3.40 sq. in.
●	3/C #10 AWG	0.20 sq. in.	20	4.00 sq. in.
⊘	3/C #2 AWG	0.80 sq. in.	20	3.20 sq. in.
Sum of Total Areas for all cables				10.60 sq. inches

Using the table on the previous page, the cable tray width required for these small cables is 12" (this has an allowable cable fill area of 14 inches).

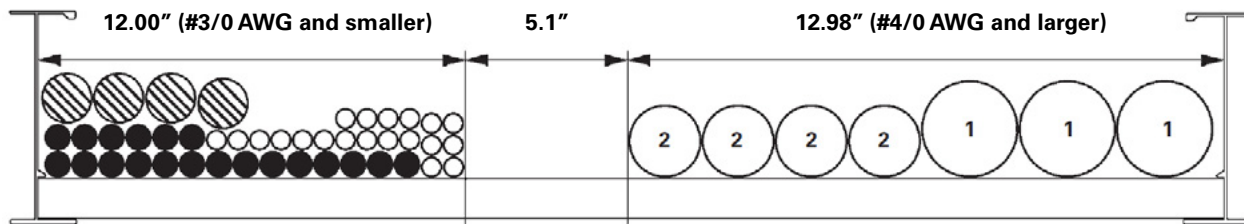

The total cable fill is 24.9 inches, which is calculated by adding 12.00 in. (#3/0 AWG and smaller) and 12.98 in. (#4/0 AWG and larger). Therefore, a cable tray with an inside width of 30 inches is required.

Width selection for cable tray containing **single conductor** cables rated 2000 volts or less

All single conductor cables to be installed in the cable tray must be 1/0 or larger, and are not to be installed with continuous bottom pans.

Single Conductor Cables 1/0 through 4/0:

These single conductors must be installed in a single layer. The sum of the diameters (Sd) for all single conductor cables to be installed shall not exceed the cable tray width.

250 KCMIL to 1000 KCMIL Cables:

The total sum of the cross-sectional areas of all the single conductor cables to be installed in the cable tray must be equal to or less than the allowable cable area for the tray width

1000 KCMIL or larger cables:

The sum of the diameters (Sd) for all single conductor cables to be installed shall not exceed the cable tray width.

1000 KCMIL or larger cables installed with cables smaller than 1000 KCMIL:

The total sum of the cross-sectional areas of all the single conductor cables to be installed in the cable tray must be equal to or less than the allowable cable area for the tray width.

Number of 600 Volt single conductor cables that may be installed in ladder tray

Single Conductor Size	Outside Diameter in.	Area sq. in.	Cable tray width				
			6 in.	9 in.	12 in.	18 in.	24 in.
1/0	0.58	—	10	15	20	31	41
2/0	0.62	—	9	14	19	29	38
3/0	0.68	—	8	13	17	26	35
4/0	0.73	—	8	12	16	24	32
250 Kcmil	—	0.55	11	18	24	35	47
350 Kcmil	—	0.69	9	14	19	28	38
500 Kcmil	—	0.90	7	11	14	22	29
750 Kcmil	—	1.29	5	8	10	15	20
1000 Kcmil	1.45	—	4	6	8	12	16

Typical Cable Tray Layout and Nomenclature

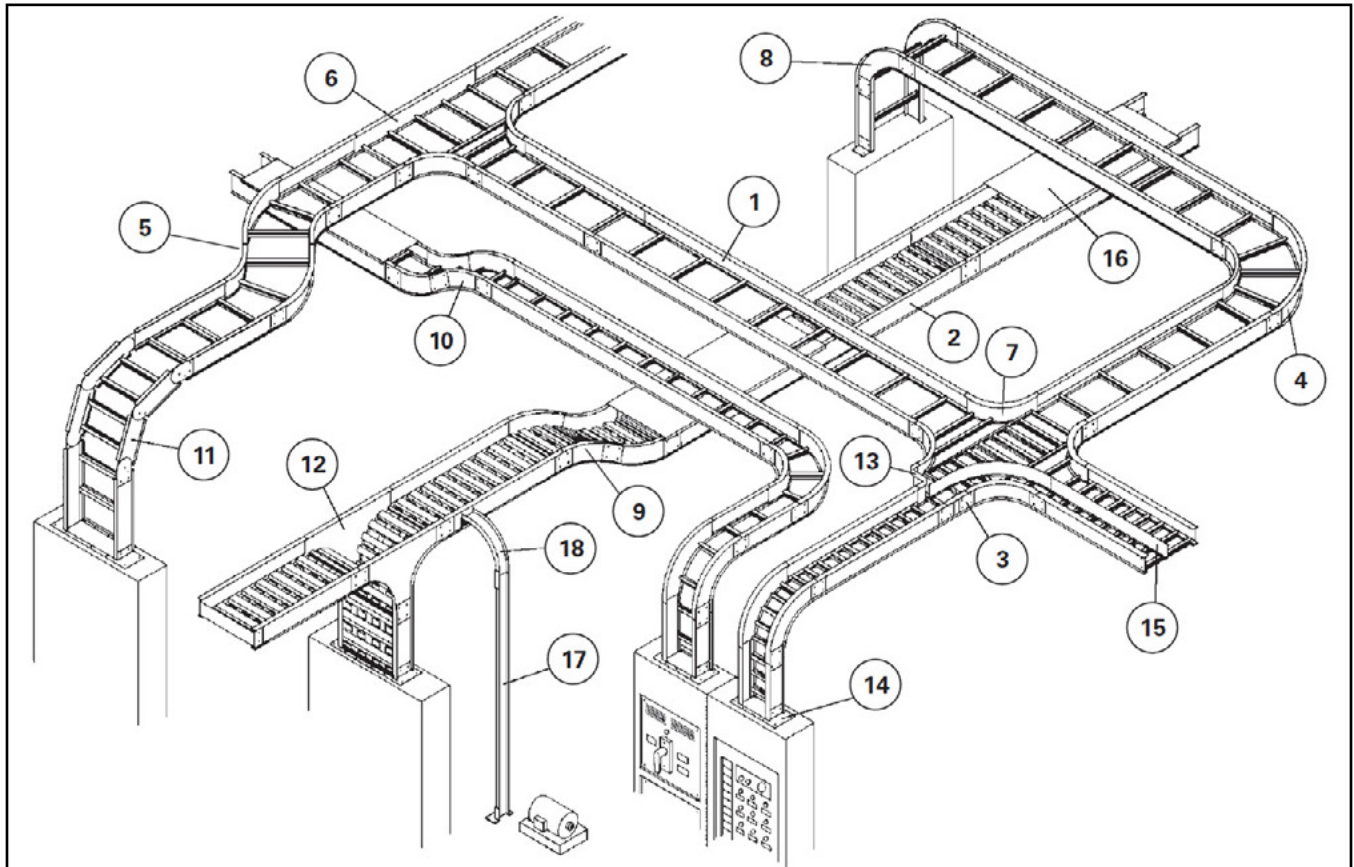

Nomenclature

1	Ladder Type Cable Tray	10	30° Vertical Inside Bend, Ladder Type Cable Tray
2	Ventilated Trough Type Cable Tray	11	Vertical Bend Segment (VBS)
3	Straight Splice Plate	12	Vertical Tee Down, Ventilated Trough Type Cable Tray
4	90° Horizontal Bend, Ladder Type Cable Tray	13	Left Hand Reducer, Ladder Type Cable Tray
5	45° Horizontal Bend, Ladder Type Cable Tray	14	Frame Type Box Connector
6	Horizontal Tee, Ladder Type Cable Tray	15	Barrier Strip Straight Section
7	Horizontal Cross, Ladder Type Cable Tray	16	Solid Flanged Tray Cover
8	90° Vertical Outside Bend, Ladder Type Cable Tray	17	Ventilated Channel Straight Section
9	45° Vertical Outside Bend, Ventilated Type Cable Tray	18	Channel Cable Tray, 90° Vertical Outside Bend

Metallic cable tray systems have two critical requirements to ensure safety and reliability.

- Electrical continuity provided over its entire length
- Support for the cables maintained across the system

These requirements can be adequately met even though there will be installation conditions where the cable tray is mechanically discontinuous, such as at a firewall penetration, at an expansion gap in a long straight cable tray run, where there is a change in elevation of a few feet between two horizontal cable tray sections of the same run, or where the cables drop from an overhead cable tray to enter equipment. In all these cases, adequate bonding jumpers must be used to bridge the mechanical discontinuity.

Lowering costs through structural steel savings



As the cost of structural steel continues to increase, the impact of reducing the quantity of supports on a cable tray project can offset the cost of the cable ladder system all together.

To achieve the lowest total installed cost, Eaton has developed an innovative cable ladder system engineered to eliminate structural steel supports and provide more flexibility around placement of the support locations, all while maintaining the structural integrity of the system. In addition, extensive laboratory testing has enabled the Eaton B-Line series cable ladder to exceed the National Electrical Manufacturer's Association (NEMA) VE-2 support recommendations for cable ladder installations.

These methods have been applied across the globe on multiple applications and projects, and have saved customers millions of dollars on structural steel.

When assessing a project for the lowest total installed cost, our [Engineering Services team](#) will work with you on these **four key design considerations** to significantly reduce the number of structural steel supports:

1. Longer straight section spans
2. Fittings support design and locations
3. Vertical adjustable support locations
4. Thermal expansion support locations

Longer straight section spans

NEMA Standard Publication VE-2, (section 3.4.1) states that "the support span should not be greater than the straight section length." Therefore, to eliminate supports, one option is to increase the length of cable ladder.

Traditionally, the industry's minimal support span for interval is 3m (10 ft). However, Eaton's B-Line series cable ladder features a highly engineered I-beam rail, which maximizes the strength-to-weight ratio of the system and allows for longer span capability.

B-Line series straight cable tray sections allow for the structural supports to be spaced up to 6m (20 ft) for steel cable ladder and up to 12m (40 ft) with aluminum cable ladder. This has the potential to reduce the number of required supports by up to 75%!

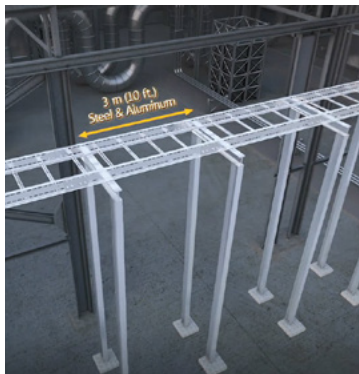

Common industry practice - Support every 3m (10 ft.)



B-Line series ladder system - steel Support every 6m (20 ft.)

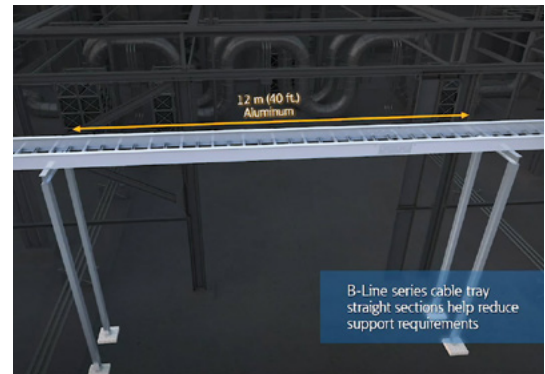

B-Line series ladder system - aluminum Support every 12m (40 ft.)

Fittings support design and locations

When it comes to installing supports, cable tray fittings are one of the biggest challenges. Eaton's B-Line series cable ladder is engineered to provide flexibility in selecting the proper support locations for fittings.

Eaton's industry-leading 3-inch (75mm) or 4-inch (100mm) tangents are specifically engineered to help maximize the strength and load carrying capacity of the complete system, which allows for a reduction in support requirements. Depending on the fittings being utilized, the installer can save up to 75% on support costs!

NEMA documentation does not require the testing of fitting locations altogether. However, Eaton has conducted extensive testing on its B-Line series cable ladder to provide several cost saving alternative options for supporting horizontal bends, tees, crosses, and vertical bends as compared to the NEMA VE-2 section 3.5.1 recommendations.



Vertical adjustable support locations

For changes in elevation with intermediate angles, and for cables not requiring a large radius, B-Line series vertical adjustable splice plates are often the best solution. NEMA VE-2 (section 3.4.3) states that a support is required within 2ft (600mm) on both sides of every vertical adjustable splice plate regardless of series or span.

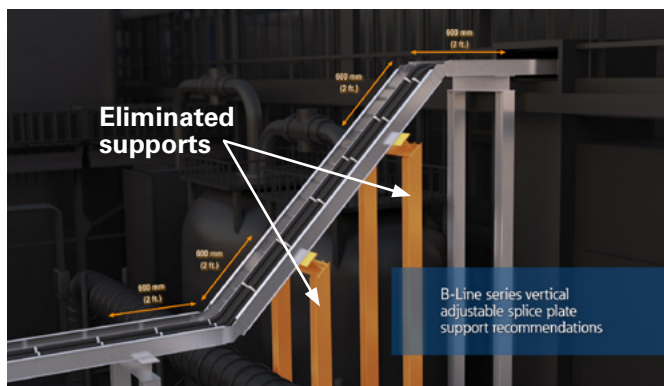

Eaton has conducted extensive testing to prove that pairing B-Line series cable ladder and vertical splice plate, installers can forego transitional supports up to half-span for steel, stainless steel, and aluminum cable ladder systems (2-5 and metric cable ladder series).

Our vertical adjustable splice plates are designed to maintain the maximum load classification of the series of cable ladder utilized across the unsupported spans.

This allows a 20ft (6m) ladder to span 10ft (3m) unsupported between adjustable splice plates. Likewise, B-Line series cable ladder series designed for 30ft (9m) spans and 40ft (12m) spans can be unsupported up to 15ft (4.5m) and 20ft (6m) respectively between vertical adjustable splice plates.

Thermal expansion support locations

Properly accounting and designing for thermal expansion and contraction is critical to the longevity of a cable ladder installation (see "Understanding thermal contraction & expansion" section in this guide).

When placed at the quarter point of a support span, Eaton's patented B-Line series heavy-duty expansion splice plate eliminates the need to install additional supports within 2ft (600 mm) on each side of the expansion location.

This equates to the elimination of 2 supports every 65ft (20m) with the typical 20ft (6m) aluminum ladder with a 100°F temperature differential.



Partner with Eaton to save big on your next project

The most significant cost driver of cable ladder installations is the supports, whether it is an industrial or commercial application. Depending on the complexity and location of the project, supports can range anywhere from \$500 to over \$15,000 each.

By utilizing B-Line series complete cable ladder system, composed of straight sections, fittings and enhanced splice plates, customers can significantly reduce the number of structural steel supports, while maintaining the system's structural integrity and exceeding industry standards.



Steel structural savings walkthrough video

To see additional details on all our design recommendations, calculate your own project savings or request a call from an Eaton representative, please visit eaton.com/sss

Steel Structural Savings Case Study

How much can you really save by incorporating any or all of Eaton's B-Line series cable ladder support recommendations? Let's take a look at a case study based on a typical bill of materials for a liquefied natural gas (LNG) terminal facility with a **25,000 ft (7620m) cable ladder system**.

Cable span length	Ladder material cost	Supports required	Support costs	Longer span savings
10 ft	\$500,000	2,500	\$3,437,500	\$1,468,750
20 ft	\$750,000	1,250	\$1,718,750	

Support design & location	Supports required	Support costs	Support savings
NEMA	2,832	\$3,688,440	\$1,561,320 to \$2,677,920
B-Line series "Floating Fitting"	1,644	\$2,127,120	
B-Line series "1/2 Span / Dual Support"	783	\$1,010,520	

Expansion splice plates	Supports required	Support costs	Support savings
Standard	416	\$588,208	\$588,208
B-Line series HD	0	\$0	

Vertical adjustable supports	Supports required	Support costs	Support savings
NEMA	112	\$112,840	\$56,000
B-Line series vertical plate	56	\$56,840	

Total cost for ladder and supports in recommended BOM (\$USD): \$3,536,110

Supports eliminated: 3,771

Total project savings (\$ USD): \$4,790,878

Support reduction savings exceed the entire cable tray project cost!

Optimize weight savings in offshore environments



A 4:1 weight saving ratio:

Weight savings in offshore applications is not limited to simply reducing the weight of individual products such as cable ladder. According to "Offshore Design Principles," OTC Paper 5257 written by N.G. Boyd, one ton of topside equipment, such as cable ladder, requires an additional one ton of topside structural steel support. This is a 1:1 ratio that continues below the water line, meaning that 2 tons of equipment and support topside requires an additional two tons of support below. For every one ton of equipment weight removed, four tons are saved overall.

Eaton can help save tons of weight and significantly improve profitability on offshore and modular construction projects

Our [B-Line series High Performance Ladder \(HPL\)](#) is designed to save weight without sacrificing load capacity. Through its engineered I-beam design, the B-Line series HPL cable ladder maximizes both material efficiency and load capacity to achieve a **5% average weight savings** over competitive published catalog weights.

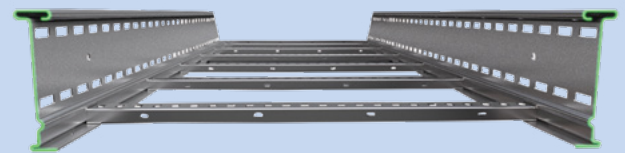

HPL load capacities exceed competitive published catalog loads through a design that maximizes the overall efficiency of the stainless steel product, allowing it to carry up to 2.3 times more load than a traditional C-channel side rail. Additionally, the I-Beam side rail is slotted to ease in the installation of splice plates and accessories, further reducing the total installed cost.

B-Line series High Performance Ladder is available in a low carbon, 316 stainless steel with 100mm, 125mm and 150mm side rail heights. It has been tested in accordance to International Electrotechnical Commission (IEC) 61537 Test Type II and is both Det Norske Veritas (DNV) certified and American Bureau of Shipping (ABS) design assessed.

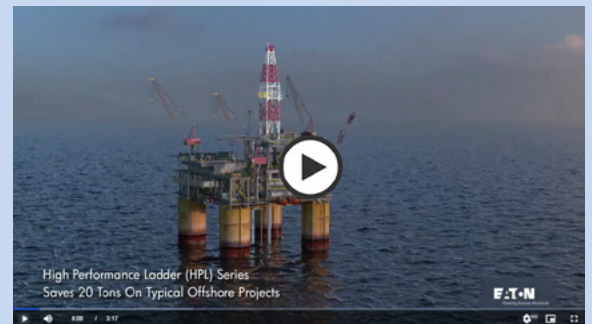

High Performance Ladder savings video - See how you can save 20 tons on your next offshore project!

The table below provides an example of the significant potential savings realized with the HPL vs. a 100-ton competitive cable ladder system.

	Competition	B-Line series HPL	Weight Saved*
Cable ladder weight	100 tons	95 tons	5 tons
Topside steel support	100 tons	95 tons	5 tons
Bottom side steel support	200 tons	190 tons	10 tons
	400 TONS	380 TONS	20 TONS SAVED

**U.S. (global headquarters):
Eaton's Crouse-Hinds business**

1201 Wolf Street
Syracuse, NY 13208

(866) 764-5454
FAX: (315) 477-5179
FAX Orders Only:
(866) 653-0640

crousecustomerctr@eaton.com

Eaton's B-Line business

509 West Monroe Street
Highland, IL 62249

800-851-7415
FAX: 618-654-1917

Eaton.com/b-lineseries

IEC Electrical
(CEAG Products)
49 (0) 6271 806-500
49 (0) 6271 806-476
info-ex@eaton.com

Airport Lighting
(866) 764-5454
crousecustomerctr@eaton.com

Mexico/Latin America/Caribbean
52-555-804-4000
FAX: 52-555-804-4020
ventascentromex@eaton.com

Haz Area Communications
(MEDC, Hernis, Oxalis, FHF, Sonix)
44 (0) 1623 444400
FAX: 44 (0) 1623 444531
MEDCAdmin@eaton.com

Canada
Toll Free: 800-265-0502
FAX: (800) 263-9504
FAX Orders only: (866) 653-0645

China
86-21-2899-3600
FAX: 86-21-2899-4055
cchsales@cooperindustries.com

Process instrumentation
(MTL products)
44 (0) 1582 723633
FAX: 44 (0) 1582 422283
info-ex@eaton.com

Eaton Middle East
971 4 8066100
FAX: 971 4 8894813
chmesales@eaton.com

Australia
61-2-8787-2777
FAX: 61-2-9609-2342
CEASales@cooperindustries.com

For more information:

If further assistance is required,
please contact an authorized Eaton
Distributor, Sales Office, or Customer
Service Department.

Eaton
1000 Eaton Boulevard
Cleveland, OH 44122
United States
Eaton.com

© 2021 Eaton
All Rights Reserved
Printed in USA
Publication No. BR400003EN
October 2021

Eaton is a registered trademark.
All other trademarks are property
of their respective owners.