



Main catalog | June 2017

Safety products

Machine safety – Jokab Safety products



Safety products catalog

ABB Jokab Safety



[Introduction](#)

1

[Safety controllers](#)

2

[Optical safety devices](#)

3

[Sensors and locks](#)

4

[Control devices](#)

5

[Emergency stops and pilot devices](#)

6

[Fence](#)

7

Introduction

Introduction and overview

Introduction	1/2
Standards and regulations	1/6

Introduction

Company overview

1

ABB Jokab Safety has been helping machine builders to create production-friendly and safe work environments for operators since 1988.



We develop products and solutions for machine safety

We make it simple to build safety systems. Developing products and solutions for machine safety has been our business idea since the company Jokab Safety, now a part of ABB, was founded in Sweden in 1988.

Many industries around the world have discovered how much easier it has become to build protection and safety systems with our components and guidance. Our extensive program of products, safety solutions and our long experience in machine safety makes us a safe partner.

Together we create a safe world!

Introduction

Company overview

Products and systems

We deliver machine safety solutions for single machines or entire production lines. Our long experience of helping customers making solutions for demanding environments has made us experts in combining production demands with safety demands for production-friendly solutions.

We market a wide range of safety products, which makes it easy to build safety systems. We develop these intelligent products continuously, in cooperation with our customers.



Our experience of safety requirements and standards

Directives and standards are very important to machine builders and safety component manufacturers. We represent Sweden in several international committees that develop standards, for e.g. industrial robots, safety distances and control system safety features. We work daily with the practical application of safety requirements in combination with production requirements. We are happy to share our knowledge of standards with our customers. You can use our experience for training and advice.

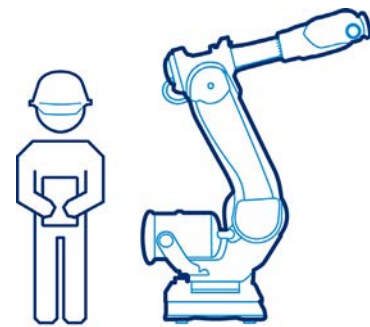

Markets and industries

Solutions from ABB Jokab Safety can be found in all types of industries across the globe. But we pride ourselves in having products and solutions that are especially well suited for e.g.:

- Robotics
- Food and beverage
- General machinery (OEM)



Our range of safety products

1



ABB is the only supplier that can deliver complete safety solutions (including output devices such as contactors and frequency converters) together with automation solutions such as robotics, motors, drives and PLCs.

Magne magnetic lock
to keep doors closed during a process

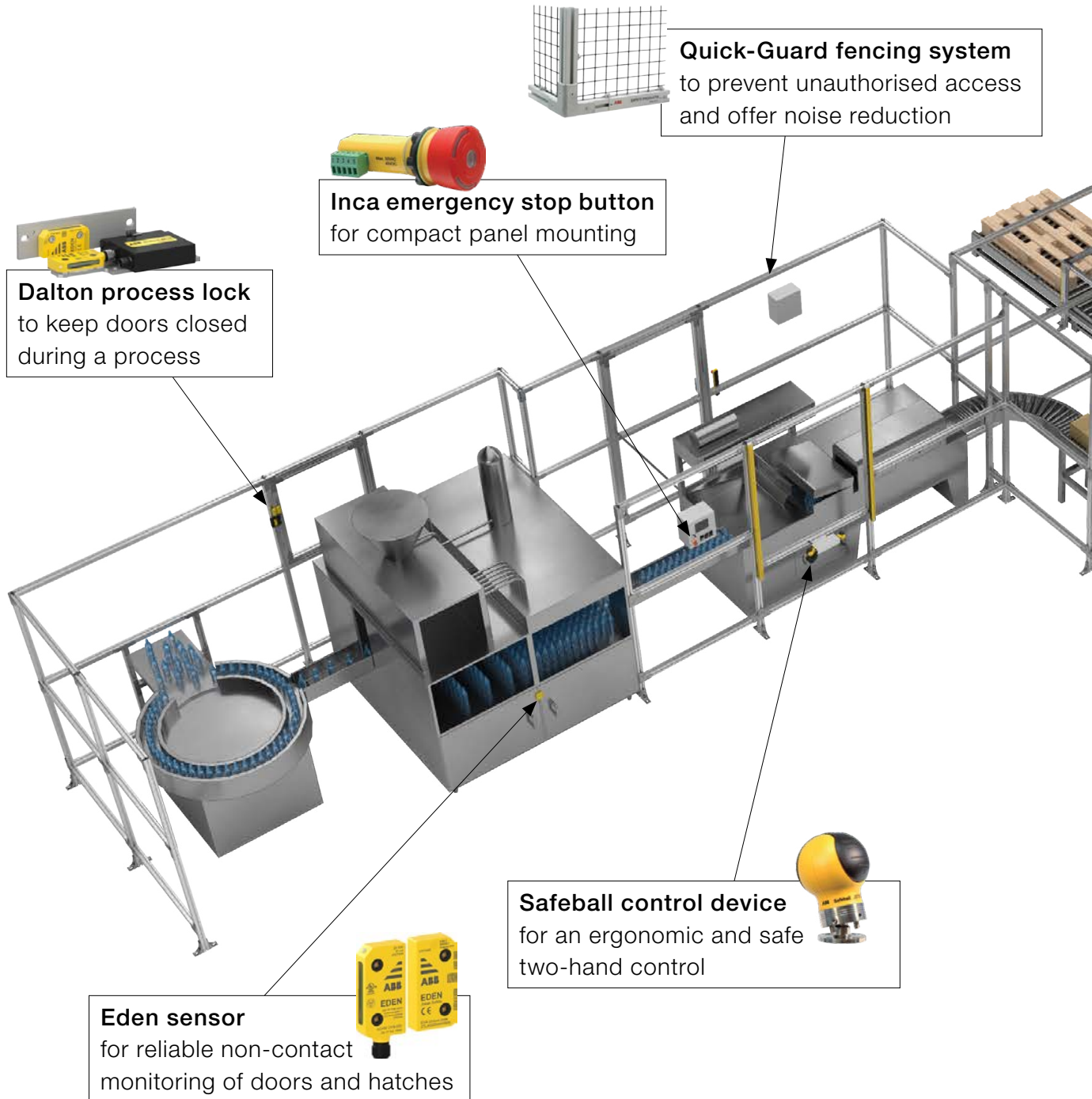
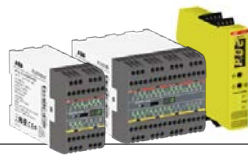

Pluto programmable safety controller, Vital safety controller and Sentry safety relays
for flexible monitoring of safety devices

Smile emergency stop button
to safely stop machinery in hazardous situations



Orion light guards
for a production friendly detection

Knox safety lock
for safe locking of doors



JSDH4 three-position device
for safe and ergonomic inspection and troubleshooting

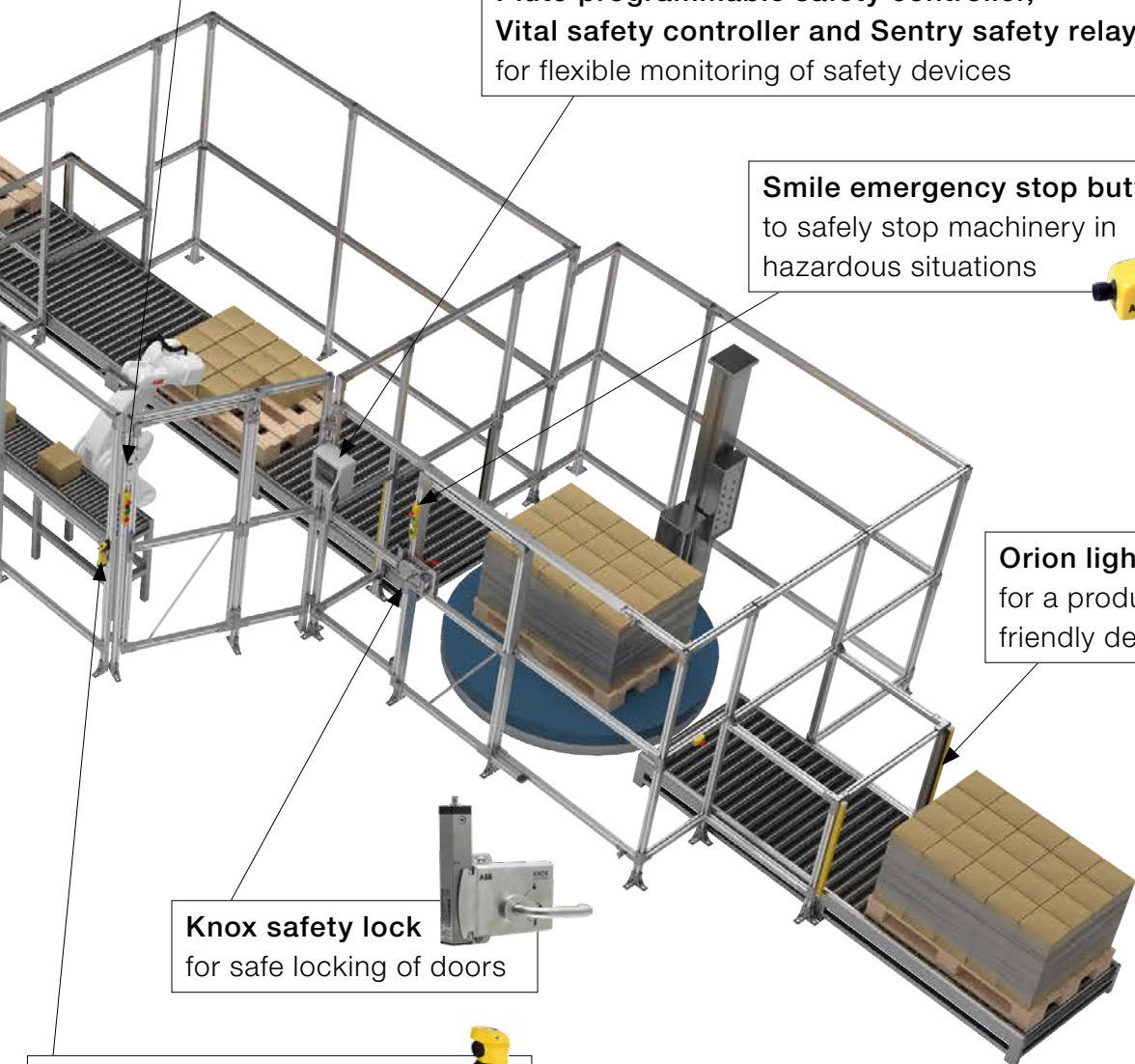

Standards and regulations

1

Directives and standards are of great importance for manufacturers of machines and safety components. International trade and global end customers makes it increasingly important to be aware of the requirements in each country. In Europe, the EU Directives are giving requirements for the minimum level of health and safety which are mandatory for manufacturers to fulfil. In each member state the Directives are implemented in the national legislation.

The European Machinery Directive

Machines which have been put on the European market since 2010 must comply with the new Machinery Directive 2006/42/EC. Before that, the old Machinery Directive 98/37/EC was valid. The objective of the Machinery Directive is to maintain, increase and equalize the safety level of machines within the members of the European Community. Based on this, the free movement of machines/products between the countries in this market can be achieved.

Harmonized standards

Standards are documents that try to give a common best solution to an issue. If a standard is harmonized, it means it gives support on how to fulfil the requirements of a specific Directive (in our case the Machinery Directive).

Examples of regularly used standards that are harmonized with the Machinery Directive

Standard		Description
EN ISO 12100	Safety of machinery - General principles for design - Risk assessment and risk reduction	The primary purpose of this standard is to provide designers with an overall framework and guidance for decisions during the development of machinery to enable them to design machines that are safe for their intended use.
EN ISO 13849-1	Safety of machinery - Safety related parts of control systems - Part 1: General principles for design	This standard provides safety requirements and guidance on the principles for the design of safety-related parts of control systems. It specifies the term performance level (PL) and the requirements to fulfill different PL.
IEC/EN 62061	Safety of machinery - Functional safety of safety-related electrical, electronic and programmable electronic control systems	This standard defines the safety requirements and guiding principles for the design of safety-related electrical/electronic/programmable parts of a control system. It specifies the term safety integrity level (SIL) and the requirements to fulfill different SIL.
EN 60204-1	Safety of machinery - Electrical equipment of machines - Part 1: General requirements	This standard provides requirements and recommendations relating to the electrical equipment of machinery so as to promote <ul style="list-style-type: none">- safety of persons and property- consistency of control response- ease of maintenance

Tools to simplify the process of safety function design

FSDT is an ABB software for determining PL and SIL of safety functions and generating technical documentation. The tool helps simplifying the process of safety function design, verification and documentation. It supports the compliance of the requirements of both EN ISO 13849-1 and IEC 62061 as well as the European Machinery Directive. Please turn to your local ABB contact in order to purchase FSDT.

Another commonly used software tool for the calculation of PL according to EN ISO 13849-1 is SISTEMA, developed by IFA (The Institute for Occupational Safety and Health) in Germany. With SISTEMA it is possible to “build” safety functions, verify them and generate the technical documentation required. The tool is freeware and can be downloaded from the IFA website.

To simplify the use of FSDT and SISTEMA with our products we have created a library containing all of our safety products.

[2TLC172300D0201](#)

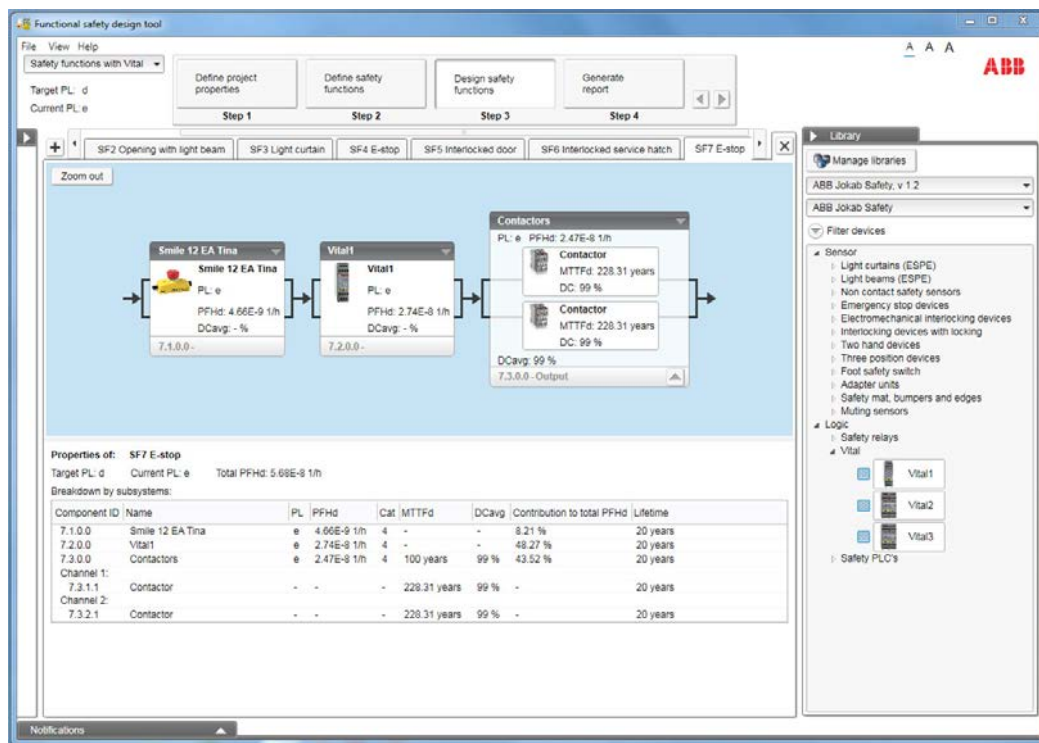



Safety controllers

Introduction and overview



Selection guide	2/2
Programmable safety controller – Pluto	2/6
Safety controller – Vital	2/18
Safety relay – Sentry	2/24

Introduction and overview

Selection guide

The safety controllers from ABB can monitor anything from a single safety function to complete manufacturing lines.

2

	Pluto	Vital	Sentry
Image			
Type	Programmable safety controller	Safety controller	Safety relay
Description	A cost-effective, powerful and compact programmable safety controller for all types of safety applications.	A configurable safety controller that can monitor all safety devices on smaller machines.	Powerful and easy-to-install safety relays suitable for all common types of safety devices.
Application(s)	Monitoring of multiple safety devices and several safety functions, as well as control of machines and/or processes. Many I/Os and programmable logic.	Monitoring multiple safety devices with one or two safety functions, with all the advantages of the DYNlink system.	Monitoring safety devices with one safety function, as well as expansion of safety outputs, with or without time delay.
Compatible safety devices	All types of conventional safety devices and DYNlink devices	DYNlink devices	All types of conventional safety devices
Advantages	<ul style="list-style-type: none"> - Easy-to-use while still allowing advanced programming - Free software - Easy system modification - Gateway communication with all main fieldbuses 	<ul style="list-style-type: none"> - Monitor up to 30 sensors in series maintaining Cat. 4/PL e - No programming 	<ul style="list-style-type: none"> - Easy to install - Universal models for all common applications - Extensive status information - Advanced timer functions - Multireset of up to 10 safety relays

Overview

Selection orientation

Conventional safety devices

By conventional safety devices, we mean safety devices with one or two channels with contacts (e.g. key switches and emergency stop buttons), devices with OSSD outputs (e.g. light guards and Eden OSSD), safety devices with solid state outputs (e.g. safety magnetic sensors) and pressure sensitive devices (e.g. safety mats, safety edges and bumpers).

A safety controller compatible with conventional safety devices can be used with most safety devices on the market, independently of the brand.

The DYNlink solution

The DYNlink solution is a unique ABB Jokab Safety feature allowing to connect safety devices in series and still reach category 4/PL e/SIL 3 with only one channel (instead of two with conventional safety devices). This saves cabling and hardware.

For a small machine, the Vital safety controller can be a very cost effective solution since up to 30 DYNlink devices can be connected to one Vital and still reach category 4/PL e/SIL 3. With conventional safety devices this would require one safety relay per safety device.

When Pluto programmable safety controller is used, only one safety input is necessary for each DYNlink circuit instead of two inputs for a traditional safety device, which means that less I/Os are necessary.

Tina adapters allow to use conventional safety devices in a DYNlink solution and transform between DYNlink signals and conventional safety signals, while maintaining the highest level of safety. This means that most conventional safety devices can be used in a DYNlink solution when used together with a suitable Tina adapter.

Programmable logic

Quite often, there is a need for logic between the different safety functions. For instance:

IF ("door A" AND "door B" are open) OR ("door C" is open) THEN "Action 1".

A logic like this can be hardwired without using programmable safety controllers, but the cabling becomes much more complicated, modifications are time consuming, errors happen more often and are difficult to find.

With a programmable safety controller, the safety devices are simply connected to the safe inputs of the controller and the logic is made in the program of the safety controller. The logic is then easy to modify without changing anything in the cabling. The Pluto Manager programming software allows to test the logic and see on the screen if there are any problems, which means much faster troubleshooting.

Pluto also offers many functions that enables it to do much more than supervising safety functions. It can e.g. control the complete manufacturing process of a smaller machine, thus saving the cost of a standard (non-safety) PLC.

Introduction and overview

Standards

Standards

Some of the more important safety standards to follow when designing safety solutions are:

EN ISO 12100 - Risk assessment

EN ISO 13849 - Performance Level

EN ISO 62061 - SIL

ISO/TR 23849 - Guidance on the use of the PL and SIL standards

EN 60204 - Electrical equipment

Programmable safety controller Pluto

2

Pluto is a cost effective, powerful and compact programmable safety controller used in a variety of applications: in large and small systems, for process and functional safety, and even on trains.

Pluto can control most types safety devices on the market, as well as ABB Jokab Safety DYNlink safety devices, analog sensors, encoders, contactors, valves and many more. Programming is done easily in the complimentary software, Pluto Manager.

The models with safety bus communication simplify the design of safety systems, thanks to our All-Master concept. A wide range of gateways allows communication with other networks and also remote monitoring of a Pluto system. Some models also offer AS-i safety.

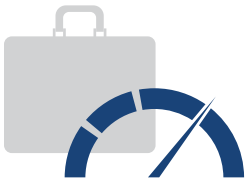

Speed up installation

Great flexibility

Up to 32 Pluto units can exchange data on the same safety bus, and the unique All-Master system allows simple scaling, splitting and modification.

Powerful yet compact

Unexpected features for its size, like real programming and speed monitoring, enables replacement of more complex PLC systems in some applications.

More sensors and less cabling

The DYNlink solution allows series connection of up to 10 safety devices on each input. StatusBus and light button feature also reduces cabling to a minimum.



Optimum interface

Programming software free of charge

Pluto Manager is an easy to use PC based programming software provided free of charge.

Easy programming

Ready-made TÜV approved function blocks for safety functions make it easy to reach PL e/SIL3. Ladder logic and text programming allow the design of more advanced functions and the control of complete machines.

Communication with external networks

Pluto gateways provide a two-way communication between the Pluto safety bus and other field buses.

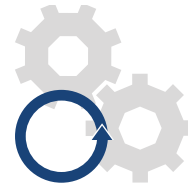

Continuous operation

Easy modification

Easy and quick replacement of units without any configuration.

Flexible monitoring

Online monitoring from any Pluto in the system and remote monitoring and control with an Ethernet gateway.

Features

Pluto

I/Os

Failsafe inputs (I) are used to connect the safety devices to be monitored. Some of them can be used as analog inputs and counter inputs. The choice is made in the Pluto program when the I/Os are configured. Depending on the model, the analog inputs can be low resolution 0-27 V or high resolution 0-10 V/4-20 mA. The fast counter inputs can handle frequencies up to 14 kHz.

Failsafe inputs/non-failsafe outputs (IQ) are terminals that can be used as failsafe inputs or communication outputs (non-failsafe). The choice is made in the Pluto program when the I/Os are configured. A specific configuration is "light button" which means that both the contact and the LED indicator of an illuminated push-button are connected to only one IQ, thus saving one I/O.

Failsafe outputs (Q) are individually safe and independently programmable outputs. There are both relay and transistor outputs. The transistor outputs deliver a negative voltage (-24 VDC) that facilitates the detection of a short circuit with other voltage potentials and increases safety. The transistor outputs are primarily intended for electromechanical components such as contactors and valves.

DYNlink solution

The DYNlink circuit is a unique solution that allows up to 10 DYNlink devices to be connected in series to a Pluto input while still reaching up to Cat. 4/PL e/SIL3. This saves inputs and cabling, since to reach the same level with standard two-channel safety devices, two inputs are necessary and series connection is not possible.

The DYNlink solution checks the signal 200 times/second and a fault such as a short circuit will be detected before any safety device is used.

Examples of DYNlink devices are Eden, Spot and Smile Tina. Most two-channel safety devices can be connected to the DYNlink solution using Tina adapters.

StatusBus functionality

The StatusBus functionality is available with some DYNlink devices and allows to collect the status of each individual safety device, even when connected in series. A single input on Pluto can collect the status of up to 30 safety devices. The devices are connected using standard cable and M12-5 connectors. No specific bus cable or extra communication module is necessary. All Pluto models offer the StatusBus functionality.

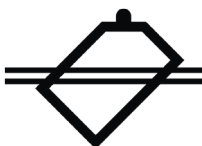

StatusBus logotype

Safety bus with All-Master function

The unique All-Master system allows simple scaling, splitting and modification of the safety system.

In a traditional safety PLC network, there is one Master and additional Slave units. But for Plutos connected to a safety bus, all units are Masters and make their own decisions, while still having the possibility to listen to what is happening to the other Plutos on the safety bus. This enables great flexibility when it comes to modification of the safety system. It also enables very simple replacement of a broken Pluto, since all Plutos have a copy of the application software of all other Plutos on the safety bus stored locally. If the replacement Pluto is given the same ID as the broken Pluto (using IDFIX), the software is downloaded from the safety bus with a simple button on the front of Pluto.

Up to 32 Pluto units can be connected to the Pluto safety bus. The Pluto S20 and S46 are stand-alone models and cannot be connected to the Pluto safety bus. All other models have bus functionality. The Safety bus functionality is necessary in order to use a Pluto gateway.

AS-i communication

AS-i reduces cabling and installation time and makes it almost impossible to connect incorrectly. Up to 62 devices/31 safety devices can be connected to a flat communication cable running around the cell. Connectors with piercing technology and self-healing cables are used (also called vampire connectors) and the sensors can easily be moved with minimum effort. AS-i Safe bus communication makes it easy to reach PL e/SIL3 and eliminates the risk of short circuit between signals in the same cable, which is not allowed for Category 4.

The ABB Jokab Safety AS-i products, including the Pluto AS-i models, are easy to use and Pluto Manager makes it easy to address the devices and read their status. Of course, ABB Jokab safety AS-i products are also compatible with AS-i products from other brands.

Pluto AS-i and Pluto B42 AS-i can either be used as masters of an AS-i bus, slaves of an AS-i master or safety monitors on an AS-i bus with another AS-i master. Therefore, they can also operate as safe I/O modules for the AS-i bus. Besides controlling all devices connected to the AS-i bus, a number of non-AS-i devices can be connected to the standard I/Os of Pluto, and there is still the possibility to communicate with other Plutos using the Pluto safety bus. In all, this leads to huge possibilities when designing the safety system.



Features

Pluto

2

Pluto Manager

Pluto Manager is the programming software for Pluto, downloaded free of charge from our website <http://new.abb.com/low-voltage/products/safety-products/programmable-safety-controllers/pluto>

An update function in Pluto Manager helps you to always have the latest version installed as long as you have an Internet connection. Pluto Manager is a user friendly PC software that allows a simple configuration of the Pluto I/Os and programming in ladder logic and with TÜV approved function blocks.



Examples of what the available function blocks can handle:

- Two-channel safety devices, with or without Reset and Monitoring.
- Single channel functions with Reset.
- Muting functions
- Encoders and counters
- Communication with Gateways, AS-i and StatusBus

Examples of ladder logic functions provided:

- Boolean instructions, Edge/inverted edge detection, Latch function, Toggle
- Timers
- Addition, Subtraction, Multiplication, Division
- Remanent memories
- Registers: 16 and 32 bit
- Sequence programming
- Option handling
- Online monitoring

In Pluto Manager there is a unique Option handling function suitable for series production of machines with different customer options. All versions of a machine type can have the same PLC program. To handle the different customer options, check boxes are used to set memories that activate the different functions of the code.

Current monitoring

Pluto A20 has a special current monitoring function. The function is mainly used to check if the connected muting lamps are working.

Harsh Environment

Pluto D20 and D45 are available in models that are suited for harsh environments and railway rolling stock in particular. These models have certificates for railway standards (e.g. EN 50126) and comply with standards for railway applications (EN 50155) that includes requirements on important electrical and mechanical aspects, as well as fire and smoke protection standard (EN 45545).

Remote monitoring and control

Remote monitoring allows the connection to a remote Pluto system via the Internet and an Ethernet gateway. Pluto Manager is used for the monitoring.

This function can be used for:

- Support of local maintenance personnel during troubleshooting
- Regular monitoring of the status of the machine or process
- Follow-up of operational data like number of cycles/day or runtime.

Pluto Manager also offers remote control of a Pluto system using the Internet and an Ethernet gateway.

With the remote control function it is possible to:

- Download a program from PC to the remote Pluto
- Configure addressing of AS-i and StatusBus slaves, write IDFIX code

The security of the remote control function is guaranteed by use of the K-button on Pluto. A change in a remote Pluto system cannot be made without a person at the remote Pluto confirming the action by pressing the K-button.

Configuration of the gateway itself, e.g. switching remote control on/off, can only be made via the programming port on the gateway and not via the Ethernet port.

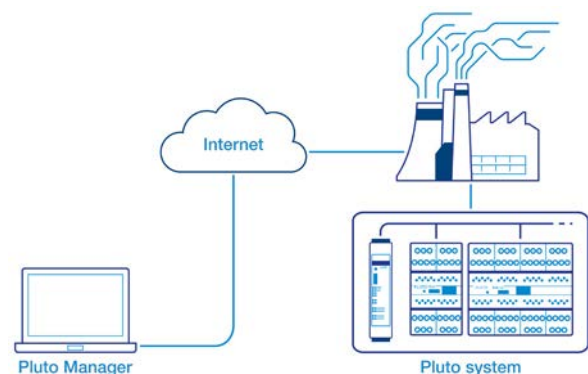

Accessories

Pluto

Pluto gateways

Pluto gateways provide two-way communication between the Pluto safety bus, i.e. all the Pluto units connected to it, and other field buses. Several models are available for the most common field buses.

Ready-made function blocks in Pluto Manager facilitate the communication. A gateway can be located anywhere on the Pluto safety bus.



Pluto safe encoders

Rotary absolute encoders can be used for safe position determination.

Our safe encoders are intended to be connected to the Pluto safety bus. They are available in single and multi-turn versions, with shaft or hollow shaft. Up to 16 absolute encoders can be connected to a Pluto safety bus. In Pluto Manager, specific function blocks make it easy to read and evaluate the values of two encoders forming a PL e/SIL3 solution. Apart from position, the speed values are available which means that also zero speed and overspeed can be monitored.

Examples of applications are gantry robots, industrial robots, and also eccentric shaft presses, where the encoders can replace existing cam mechanisms.



Operator panels

An operator panel can be connected to the programming port of Pluto with a specific cable and communicate with Pluto in MODBUS ASCII. We recommend the ABB CP600 series operator panels that offer the appropriate communication driver.

An operator panel can also communicate with Pluto via a GATE-MT gateway.



Ordering information

Pluto

2

Pluto ordering table

Pluto is available in different models depending on the needs of your application. Optional features includes bus communication, AS-i bus, high resolution analog inputs, current monitoring and adaption for harsh environments.

AS-i	Safety bus	Failsafe outputs ^{a)}	Failsafe inputs (max) ^{b)}	Analog inputs (max) ^{b)}	Fast counter inputs (max) ^{b)}	StatusBus inputs (max) ^{b)}	Non failsafe outputs (max) ^{b)}	Width mm	Type	Order code
No	No	4	16	1 ^{c)}	-	4	8	45	Pluto S20	2TLA020070R4700
		6	40	3 ^{c)}	-	4	16	90	Pluto S46	2TLA020070R1800
	Yes	-	22	1 ^{c)}	-	4	8	45	Pluto B22 ^{e)}	2TLA020070R4800
		2	4	-	-	2	2	45	Pluto O2 ^{f)}	2TLA020070R8500
		4	16	1 ^{c)}	-	4	8	45	Pluto A20 ^{g)}	2TLA020070R4500
									Pluto B20	2TLA020070R4600
									Pluto D20 (Harsh Env) ^{h)}	2TLA020070R6400
		6	40	3 ^{c)}	-	4	4	90	Pluto B46	2TLA020070R1700
Pluto D45	2TLA020070R6600									
Pluto D45 (Harsh Env) ^{h)}	2TLA020070R6601									
Yes	Yes	4	8	4 ^{c)}	-	4	4	45	Pluto AS-i	2TLA020070R1100
		6	36	3 ^{c)}	-	4	16	90	Pluto B42 AS-i	2TLA020070R1400



Pluto S20 v2

2TLC010039V0201



Pluto A20 v2

2TLC010038V0201



Pluto D45

2TLC010029V0201



Pluto AS-i

2TLC010011V0201

a) Failsafe outputs
2 failsafe outputs:
- 2 independent individually safe potential free relay outputs (Q0 and Q1) with 3 contacts each

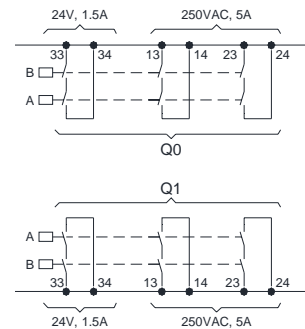

4 failsafe outputs:
- 2 independent individually safe potential free relay outputs (Q0 and Q1)
- 2 independent individually safe transistor outputs (-24 VDC) (Q2 and Q3)

6 failsafe outputs:
- 2 independent individually safe potential free relay outputs (Q0 and Q1)
- 2 independent individually safe potential free relay outputs with common supply (Q4 and Q5)
- 2 independent individually safe transistor outputs (-24 VDC) (Q2 and Q3)

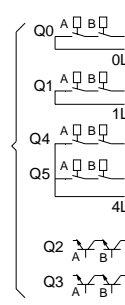

b) -The number of failsafe inputs available decreases with the number of used non-failsafe outputs, analog inputs, fast counter inputs and StatusBus inputs.
-The number of analogue inputs available decreases with the number of used fast counter inputs.
-The number of non-failsafe outputs available decreases with the number of StatusBus inputs used.
Check the [Pluto hardware manual](#) for more information.

- c) 0-27 V analog inputs
- d) 0-10 V/4-20 mA (high resolution) analog inputs
- e) Expansion model with failsafe inputs and no failsafe outputs.
- f) Expansion model with 2 failsafe outputs with 3 contacts each. Also possible to use as stand-alone unit.
- g) Model with current monitoring
- h) Pluto D20 (Harsh Env) and Pluto D45 (Harsh Env) have coated circuit boards and can be used in severe environments where cold and condensation can cause problems, like on trains and other vehicles and in the wind energy segment.
 - They comply with railway standard EN 50155
 - They can be used on all trains up to the highest hazard level (HL3) according to the fire and smoke protection standard EN 45545.

Ordering information

Pluto accessories



IDFIX-R

2TLA020070R2001



IDFIX-RW

2TLA020070R2101



IDFIX-DATA

2TLA020070R2301



IDFIX-PROG 2k5

2TLA020070R2401



IDFIX-PROG 10k

2TLA020070R2601



FIXA



R120 Resistor

2TLA081200R1501

IDFIX identifiers

IDFIX is an identification circuit that is connected to Pluto. It must be used:

- when several Pluto are connected to the Pluto Safety bus (IDFIX-R or IDFIX-RW)
- with Pluto AS-i and Pluto B42 AS-i (IDFIX-DATA)
- to get the possibility to replace a stand-alone Pluto with a new one without the need of a PC (IDFIX-PROG stores the Pluto program)

Description	Type	Order code
Pre-programmed unique identification number.	IDFIX-R	2TLA020070R2000
Programmable identification number, i.e. the user can choose the identification number.	IDFIX-RW	2TLA020070R2100
Programmable identification number and storage of AS-i safety codes. Must be used with Pluto AS-i and Pluto B42-AS-i.	IDFIX DATA	2TLA020070R2300
Programmable identification number and storage of the Pluto program, 2.5 Kbyte. Especially useful for stand-alone Pluto.	IDFIX-PROG 2k5	2TLA020070R2400
Programmable identification number and storage of the Pluto program, 10 Kbyte. Especially useful for stand-alone Pluto.	IDFIX-PROG 10k	2TLA020070R2600

Pluto cables and connection accessories

Description	Type	Order code
Pluto programming and on-line monitoring cable. For a PC serial port, 9-pole D-sub connector.	Pluto cable serial	2TLA020070R5600
Pluto programming and on-line monitoring cable. For a PC USB port.	Pluto cable USB	2TLA020070R5800
Cable for connecting a HMI-panel to the Pluto programming port. Connector on HMI-side: 15-pole D-sub. On Pluto side: 90 degrees angled Modbus contact.	Pluto cable HMI	2TLA020070R5700
Cable for connecting HMI-panel ABB CP400 to Pluto programming port. Connector on HMI-side: 9-pole D-sub.	Pluto cable CP400	2TLA020070R6700
Cable for connecting HMI-panel ABB CP600 to Pluto programming port. Connector on HMI-side: 9-pole D-sub.	Pluto cable CP600	2TLA020070R6900
Bus cable for Pluto safety bus, 2 x 0.75 mm ² . Ordered by meter, cut to size. Minimum order length 10 m.	PCABLE-000	2TLA020070R6800
Bus cable for Pluto safety bus, 2 x 0.75 mm ² . 50-meter ring.	PCABLE-050	2TLA020070R6805
Bus cable for Pluto safety bus, 2 x 0.75 mm ² . 100-meter ring.	PCABLE-100	2TLA020070R6810
Bus cable for Pluto safety bus, 2 x 0.75 mm ² . 500-meter drum.	PCABLE-500	2TLA020070R6850
Bus cable for Pluto safety bus, 2 x 0.75 mm ² . Halogen free. Ordered by meter, cut to size. Minimum order length 10 m.	PCABLE-000-HF	2TLA020070R8600
Bus cable for Pluto safety bus, 2 x 0.75 mm ² . Halogen free. 50-meter ring.	PCABLE-050-HF	2TLA020070R8605
Bus cable for Pluto safety bus, 2 x 0.75 mm ² . Halogen free. 100-meter ring.	PCABLE-100-HF	2TLA020070R8610
Bus cable for Pluto safety bus, 2 x 0.75 mm ² . Halogen free. 500-meter drum.	PCABLE-500-HF	2TLA020070R8650
Terminal block with capacitor, 12nF, for connection between 0 V of Pluto supply and earth in order to reduce problems with conducted disturbances.	Pluto capacitor	2TLA020070R3200

Other accessories

Description	Type	Order code
Set of function blocks for mechanical presses.	Pluto press block	2TLA020070R4100
Smile reset button for light button function with M12-5 connector.	Smile 11 RB	2TLA030053R0100
Handheld terminal AS-i/StatusBus. Used for e.g. addressing and test. Connection to PC via USB-micro cable	FIXA	2TLA020072R2000
Terminating resistor for Pluto safety bus. Necessary for each stand-alone Pluto and on the Pluto units at each end of the Pluto safety bus. Should be removed from the other Pluto units.	R120 Resistor	2TLA020070R2200

Pluto spare parts (included when ordering a Pluto)

Description	Type	Order code
Contact block for safety relays and Pluto. 7 poles. Grey.	Contact block 7 grey	2TLA081200R1500

Ordering information

DYNlink solution

2



Tina 2A

2TLC172453F0201



Tina 2B

2TLC172457F0201



Tina 3A

2TLC172469F0201



Tina 7A

2TLC172469F0201



Tina 10A

2TLC172473F0201



Tina 10B

2TLC172475F0201



Tina 10C

2TLC172477F0201



Tina 6A

2TLC172467F0201

Tina adaptation units to DYNlink

The Tina devices adapt the DYNlink signals from Pluto to safety components with mechanical contacts, such as E-stops, switches and light beams/curtains with dual outputs. Tina is available in several versions depending on the type of safety component that is connected to the DYNlink solution. Also available is connector blocks and a blind plug.

Type of safety device	Type of connection to the DYNlink loop	Description	Type	Order code
Devices with positively driven force-guided contacts like E-stop buttons and key switches	Via the device connection	Mounted directly on the device enclosure to a M20 cable entry.	Tina 2A	2TLA020054R0100
		Placed inside the safety device enclosure	Tina 2B	2TLA020054R1100
	M12-5 male connector	Mounted directly on the device enclosure to a M20 cable entry.	Tina 3A	2TLA020054R0200
	M12-5 male connector with extra conductor for the supply of the safety device	Two circuits and with supply voltage for the safety sensor. Connects to a M20 cable entry.	Tina 3Aps	2TLA020054R1400
Devices with OSSD outputs like Orion light guards	Removable terminal blocks	Mounted on a DIN rail in the electrical cabinet. Note that the connected safety device(s) must be mounted on the same cabinet.	Tina 7A	2TLA020054R0700
	M12-5 male connector	Adaptation of OSSD to DYNlink. Two M12 connectors.	Tina 10A	2TLA020054R1200
		Adaptation of OSSD to DYNlink with possibility to connect a local reset button. Three M12 connectors.	Tina 10B	2TLA020054R1300
Safety mats, edges and bumpers with short-circuit detection		Adaptation of OSSD to DYNlink with possibility to power the transmitter. Three M12 connectors.	Tina 10C	2TLA020054R1600
	M12-5 male connector	Short-circuit detection and adaptation to DYNlink.	Tina 6A	2TLA020054R0600

Connection blocks for serial connection of DYNlink devices (or devices with Tina adapter)

Description	Type	Order code
Connection block for the serial connection of up to 4 DYNlink devices with M12-5 connectors	Tina 4A	2TLA020054R0300
Connection block for the serial connection of up to 8 DYNlink devices with M12-5 connectors	Tina 8A	2TLA020054R0500
Connection block for the serial connection of two DYNlink devices with M12-5 connectors	Tina 11A	2TLA020054R1700
Connection block for the serial connection of two DYNlink devices with M12-8 connectors, e.g. Dalton and Magne.	Tina 12A	2TLA020054R1800

Blind plug to complete the serial connection on a connection block

All M12 connectors on Tina 4A or Tina 8A must be connected to a safety device or a Tina 1A. For example, if only 6 devices are connected to a Tina 8A, two Tina 1A are necessary.

Description	Type	Order code
Tina 1A is a blind plug connected to the unused M12 connectors of the connection blocks Tina 4A and Tina 8A.	Tina 1A	2TLA020054R0000

Ordering information

Accessories



GATE-C2

2TLC172609F0201



GATE-EC

2TLC172843F0201



RSA 597

2TLC172331F0201



RSA 698

2TLC172546F0201



CP604

Pluto gateways

With the use of a gateway, Pluto can communicate with other control systems and form a part of a larger network. The gateway models GATE-D2 and C2 can also be used as an extension of the safety bus cable to extend the Pluto network.

Fieldbus	Ethernet	Type	Order code
CANopen		GATE-C2	2TLA020071R8100
DeviceNet		GATE-D2	2TLA020071R8200
PROFIBUS-DP		GATE-P2	2TLA020071R8000
EtherCAT	x	GATE-EC	2TLA020071R9100
Ethernet/IP	x	GATE-EIP	2TLA020071R9000
Modbus TCP	x	GATE-MT	2TLA020071R9400
PROFINET	x	GATE-PN	2TLA020071R9300
SERCOS III	x	GATE-S3	2TLA020071R9200

For more information, see the gateway manuals:

Pluto gateways [2TLC172009M0210](#)

Pluto Ethernet gateways [2TLC172285M0203](#)

Pluto safe encoders

The safe encoders can be used together with Pluto to safely determine the position of machine movements.

Function	Shaft	Shaft diameter (mm)	Type of connection	Type	Order code
Single-turn	Solid	10	Connector male 12 poles	RSA 597 connector	2TLA020070R3600
		6	1.5 m cable	RSA 597 1.5 m cable	2TLA020070R3300
	Hollow	12	2 m cable	RHA 597 2 m cable	2TLA020070R3400
			10 m cable	RHA 597 10 m cable	2TLA020070R5900
Multi-turn	Solid	6	M12 connector	RSA 698 6 mm solid	2TLA020071R7800
		10	M12 connector	RSA 698 10 mm solid	2TLA020070R3700
	Hollow	12	M12 connector	RHA 698 hollow	2TLA020071R7900

For more information, see the manual:

Pluto safe encoders [2TLC172006M0206](#)

Pluto safe encoders accessories

Description	Type	Order code
Female 12 pole connector to be used with absolute encoder "RSA 597 connector". Connector to be mounted on the cable.	Connector for absolute encoder	2TLA020070R3900
M12 plug with Pluto safety bus termination resistor. To be used when the encoder is at one end of the Pluto safety bus.	M12-CANend	2TLA020061R0300

Operator panels

An operator panel (also called HMI) can be connected to the Pluto programming port (on the Pluto front) with a special cable and communicate with Pluto using MODBUS ASCII. We recommend the ABB CP600 series that offer the appropriate communication driver. An operator panel can also communicate with Pluto via a GATE-MT gateway.

Description	Type	Order code
Operator panel, 4.3" touch screen, 480 x 272 pixels	CP604	1SP504100R0001

For more sizes and version, see: <http://new.abb.com/plc/control-panels>

Ordering information

AS-i

2



AS-i cable yellow

2TLC172742R0201

Cables and connection accessories for AS-i

Description	Type	Order code
Cable for AS-i, power and data, +30 VDC, yellow, EPDM	AS-i cable yellow	2TLA020074R9000
Cable for AS-i, additional power, +24 VDC, black, EPDM	AS-i cable black	2TLA020074R9100
M12-5 female connector with vampire connector for AS-i flat cable.	AS-i T-connector M12	2TLA020073R0000
AS-i flat cable splitter used to make T-connections and to extend cables.	AS-i splitter box	2TLA020073R0300

AS-i accessories

Description	Type	Order code
Handheld terminal AS-i/StatusBus, used for e.g. addressing and test. Connection to PC via USB-micro cable. Connection to PC via USB-micro cable.	FIXA	2TLA020072R2000
Cable for addressing M12-5 devices like Adam AS-i with Fixa. 1 m cable 5 x 0.34 mm ² + screen with straight M12 female + male connectors. Screen connected to pin3 (0 V) on male connector.	M12-C112	2TLA020056R2000
Cable for addressing Urax adapters with Fixa. M12-5 male connector on one side and jack socket on the other side.	AS-i addressing cable	2TLA020073R0300



FIXA

Urax adaptation devices for AS-i

Urax are adaptation devices for the AS-i bus that enables the connection of safety sensors and non-safe products to AS-i safety.



URAX-A1

Type of safety device to connect	Non-failsafe outputs ¹⁾	Local reset ²⁾	Type	Order code
DYNlink devices, e.g. Eden. Up to three devices in series	1	No	URAX-A1	2TLA020072R0000
		Yes	URAX-A1R	2TLA020072R0100
DYNlink devices with need for extra power, e.g. Magne, Knox and Dalton. Up to 10 devices in series. Black AS-i cable needed.	3	Yes	URAX-B1R	2TLA020072R0200
Devices with two potential free contacts, NO + NO or NO + NC, e.g. Smile and MKey.	-	No	URAX-C1	2TLA020072R0300
		Yes	URAX-C1R	2TLA020072R0400
Devices with OSSD outputs, e.g. Orion light guards. Black AS-i cable needed.	3	Yes	URAX-D1R	2TLA020072R0500
Two-hand devices according to EN 574 type IIIC, e.g. two Safeball.	-	No	URAX-E1	2TLA020072R0600

1) Non-failsafe outputs can be used for e.g. indicators and locking signal.

2) Possibility to connect an illuminated push-button to Urax, to reset the safety devices connected to Urax. All models with local reset possibility can still be used with manual or automatic reset.

For more information, see the user manual:

Urax [2TLC172008M0201](#)

Accessories to Urax adapters

Description	Type	Order code
Bracket for mounting Urax on ABB Jokab Safety fence system. Includes fasteners.	JSM D25	2TLA020070R3900
URAX bottom plate	URAX Bottom	2TLA020072R9900
M12 plug needed when Urax with local reset possibility (URAX-x1R) is used in automatic reset.	JSAUR1	2TLA020073R0100





JSAUR1

2TLC172763R0201

Technical data

Pluto

Technical data

Approvals	   Railway: TÜV Rheinland InterTraffic		
Conformity	CE 2006/42/EC - Machinery 2014/30/EU - EMC 2011/65/EU - RoHS EN ISO 13849-1:2008+AC:2009, EN 62061:2005, IEC 61511-1:2003+Corr.1:2004, EN 50156-1:2004, IEC 61508:2010, EN 60204-1:2006+A1:2009, EN 50178:1997, EN 61496-1:2004+A1:2008+AC:2010, EN 574:1996+A1:2008		
Functional safety data		PFH _p Failsafe relay outputs	PFH _p Failsafe
EN 61508:2010	SIL3	2.00 x 10 ⁻⁹	1.5 x 10 ⁻⁹
EN 62061:2005+A1:2013	SILCL3	2.00 x 10 ⁻⁹	1.5 x 10 ⁻⁹
EN ISO 13849-1:2008	PL e/Cat.4	2.00 x 10 ⁻⁹	1.5 x 10 ⁻⁹
Electrical data			
Electrical insulation	Category II in accordance with IEC 61010-1		
Operating voltage	+24 VDC ± 15%		
Failsafe outputs Q	Transistor, -24 VDC, 800 mA		
Q2, Q3 Q0, Q1, (Q4, Q5)	Relay outputs AC-12: 250 V / 1.5 A VAC-15: 250 V / 1.5 A VDC-12: 50 V / 1.5 A DC-13: 24 V / 1.5 A	Pluto O2 Relay outputs AC-12: 250 V / 5 A AC-15: 250 V / 3 A DC-12: 60 V / 5 A DC-13: 24 V / 3 A	Pluto O2 Relay outputs (33-34) AC-12: 24 V / 1.5 A AC-15: 24 V / 1.5 A DC-12: 24 V / 1.5 A DC-13: 24 V / 1.5 A
Installation	35 mm DIN rail		
Ambient temperature	-10 °C to +50 °C		
Pluto safety bus			
Max. number of Pluto units	32		
Cable length	Up to 600 m		
Pluto AS-i bus			
Number of slave units	31 safe slaves, 62 non-safe slaves		
Bus cable length	Up to 500 m		

More information

For more information, e.g. the complete technical information, see product manual:
 Pluto hardware manual [2TLC172009M0210](#)

Dimension drawings Pluto

Single size

2

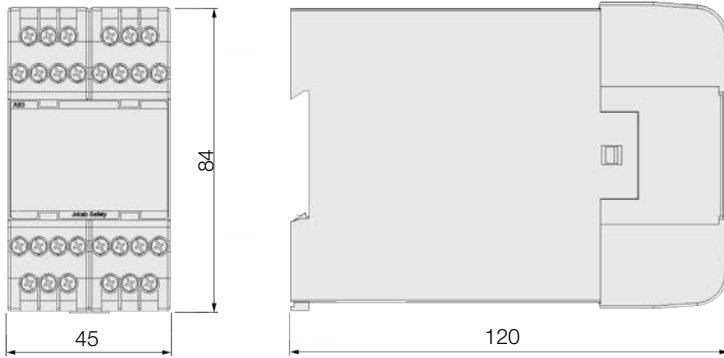

Double size

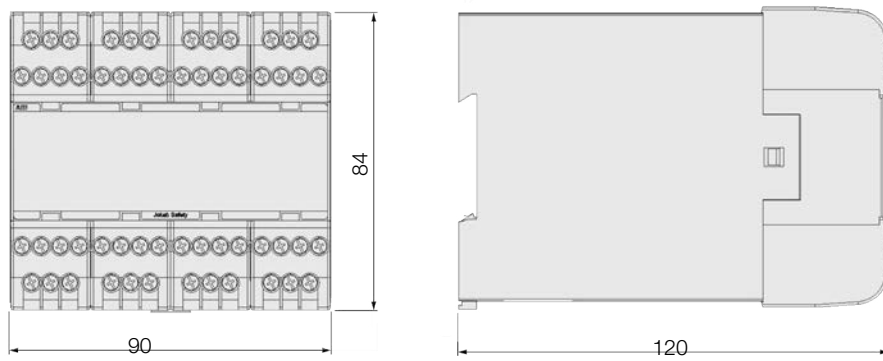

All dimensions in mm

Safety controller Vital

2

Vital is a configurable safety controller that does not require programming. It uses the DYNlink system, which allows up to 30 safety devices to be connected in series to the same circuit, while achieving PL e.

This enables a single Vital to supervise all safety functions on many machines that otherwise would have required a programmable safety controller or multiple safety relays.

Vital is also commonly used to supervise all emergency stops for larger machine lines.

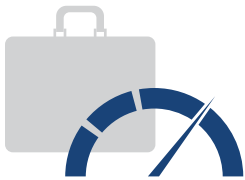

Speed up your projects

Easy connection

Reduced installation and engineering time thanks to simple installation with serial connection using M12 connectors.

No programming required

The use of only one safety module without any programming simplifies engineering, commissioning and replacement.

Less components

Significantly less components needed to achieve PL e/SIL 3.



Continuous operation

LED diagnostics

Integrated LED diagnostics reduces down time when troubleshooting.

Detachable connection blocks

Detachable connection blocks simplify replacement.

Exchange without configuration

The configuration is made with jumpers in the detachable connection blocks. In case of exchange, the new unit automatically gets the correct configuration.



Safety and protection

Easy to reach highest safety level

The DYNlink solution makes it possible to maintain the highest level of safety with up to 30 sensors connected in series.

Extensive fault detection

The DYNlink solution enables unique fault detection features and prevents 2-channel faults.

Applications and features

Vital

Applications

Vital safety controller excels at supervising multiple safety devices on the same machine, since up to 30 safety devices can be connected in series to the same input while achieving up to PL e.

Typical applications are machines with multiple doors/hatches or emergency stop buttons.

Models

Vital 1 Safety controller

- One DYNlink circuit with up to 30 safety devices
- 2 safe outputs

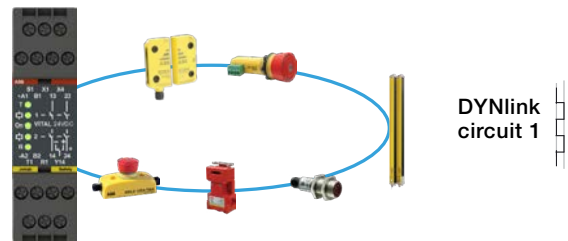

Vital 2 Safety controller

- Two DYNlink circuits with up to 10 safety devices each
- 2 x 2 safe outputs
- A time delay of up to 1.5 s can be set for output group 2
- 3 different modes can be configured:
 1. DYNlink circuit 1 controls output group 1, DYNlink circuit 2 controls output group 2
 2. DYNlink circuit 1 controls both output groups, DYNlink circuit 2 controls output group 23.
 3. Both circuits control both output groups in parallel

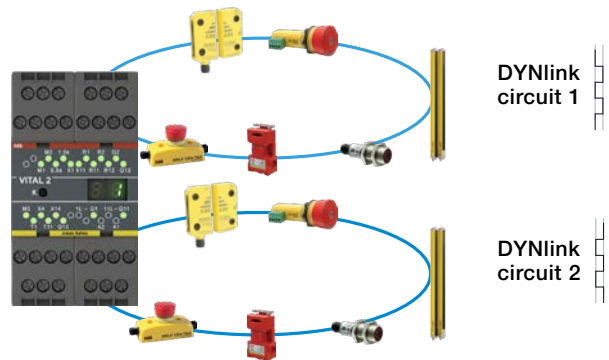

Vital 3 Safety controller

- One NC circuit for two-channel NC contact safety devices
- One DYNlink circuit with up to 10 safety devices
- 2 x 2 safe outputs
- A time delay of up to 1.5 s can be set for output group 2
- 3 different modes can be configured:
 1. NC circuit controls output group 1, DYNlink circuit controls output group 2
 2. NC circuit controls both output groups, DYNlink circuit controls output group 2
 3. Both circuits control both output groups in parallel

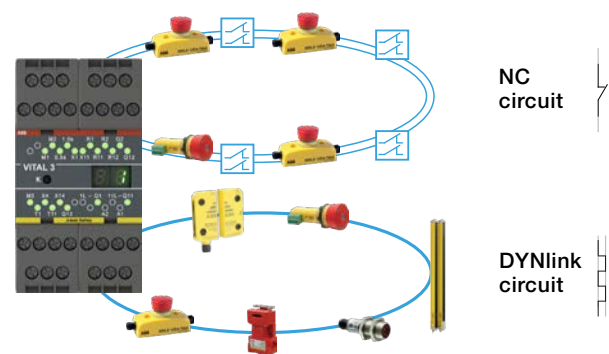

Features

DYNlink

The DYNlink circuit is a unique solution that uses one single channel to achieve up to Cat. 4/PL e. Vital sends out a square wave signal that is inverted by each safety device. A connection between B1 and S1 sets if Vital should receive a non-inverted signal, i.e. an even number of devices are connected (no shunt indicates an odd number). Vital checks the returning signal 200 times/second and a fault such as a short circuit will be detected before any safety device is used.

Vital can only be used with DYNlink safety device, such as Eden DYN, and devices with a Tina adapter.

Ordering information

Vital

2



2TLC01010V0201

Vital 1



2TLC17245F0201

Tina 2A



2TLC17245F0201

Tina 2B



2TLC17245F0201

Tina 3A



2TLC17246F0201

Tina 7A



2TLC172473F0201

Tina 10A



2TLC172475F0201

Tina 10B



2TLC172467F0201

Tina 6A

Description

DYNlink circuits	Static circuit (2 NC)	Maximum DYNlink devices	Safe outputs	Delayable outputs	Type	Order code
1		30	2 NO		Vital 1	2TLA020052R1000
2		10 + 10	2 NO + 2 transistor (-24 V)	Yes	Vital 2	2TLA020070R4300
1	1	10	2 NO + 2 transistor (-24 V)	Yes	Vital 3	2TLA020070R4400

Tina adaptation units to DYNlink

The Tina devices adapt the DYNlink signals from Pluto to safety components with mechanical contacts, such as E-stops, switches and light beams/curtains with dual outputs. Tina is available in several versions depending on the type of safety component that is connected to the DYNlink solution. Also available is connector blocks and a blind plug.

Type of safety device	Type of connection to the DYNlink loop	Description	Type	Order code
Devices with positively driven force-guided contacts like E-stop buttons and key switches	Via the device connection	Mounted directly on the device enclosure to a M20 cable entry. Placed inside the safety device enclosure	Tina 2A	2TLA020054R0100
	M12-5 male connector	Mounted directly on the device enclosure to a M20 cable entry.	Tina 2B	2TLA020054R1100
	M12-5 male connector with extra conductor for the supply of the safety device	Two circuits and with supply voltage for the safety sensor. Connects to a M20 cable entry.	Tina 3A	2TLA020054R0200
	Removable terminal blocks	Mounted on a DIN rail in the electrical cabinet. Note that the connected safety device(s) must be mounted on the same cabinet.	Tina 3Aps	2TLA020054R1400
Devices with OSSD outputs like Orion light guards	M12-5 male connector	Adaptation of OSSD to DYNlink. Two M12 connectors.	Tina 7A	2TLA020054R0700
		Adaptation of OSSD to DYNlink with possibility to connect a local reset button. Three M12 connectors.	Tina 10A	2TLA020054R1200
		Adaptation of OSSD to DYNlink with possibility to power the transmitter. Three M12 connectors.	Tina 10B	2TLA020054R1300
Safety mats, edges and bumpers with short-circuit detection	M12-5 male connector	Adaptation of OSSD to DYNlink with possibility to power the transmitter. Three M12 connectors. Short-circuit detection and adaptation to DYNlink.	Tina 10C	2TLA020054R1600
			Tina 6A	2TLA020054R0600

Connection blocks for serial connection of DYNlink devices (or devices with Tina adapter)

Description	Type	Order code
Connection block for the serial connection of up to 4 DYNlink devices with M12-5 connectors	Tina 4A	2TLA020054R0300
Connection block for the serial connection of up to 8 DYNlink devices with M12-5 connectors	Tina 8A	2TLA020054R0500
Connection block for the serial connection of two DYNlink devices with M12-5 connectors	Tina 11A	2TLA020054R1700
Connection block for the serial connection of two DYNlink devices with M12-8 connectors, e.g. Dalton and Magne.	Tina 12A	2TLA020054R1800

Blind plug to complete the serial connection on a connection block



All M12 connectors on Tina 4A or Tina 8A must be connected to a safety device or a Tina 1A. For example, if only 6 devices are connected to a Tina 8A, two Tina 1A are necessary.

Description	Type	Order code
Tina 1A is a blind plug connected to the unused M12 connectors of the connection blocks Tina 4A and Tina 8A.	Tina 1A	2TLA020054R0000

Technical data

Vital

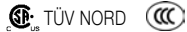
Technical data

	Vital 1	Vital 2/Vital 3
Approvals		
Conformity	CE 2006/42/EC - Machinery 2014/30/EU - EMC 2011/65/EU - RoHS EN ISO 12100:2010, EN ISO 13849-1:2015, EN 62061:2005+A1:2013, +Cor.:2010, EN 60664-1:2007, EN 61000-6-2:2016, EN 61000-6-4:2007, EN 61496-1:2013	CE 2006/42/EC - Machinery 2014/30/EU - EMC 2011/65/EU - RoHS EN ISO 13849-1:2008+AC:2009, EN 62061:2005, EN 61496-1:2004+A1:2008+AC:2010, EN 60204-1:2006+A1:2009, EN 50156:2004, IEC 61511-1:2003+Corr.1:2004, EN 50178:1997, EN 61000-6-2:2005, EN 61000-6-4:2007+A1:2011, IEC/EN 61508:2010
Functional safety data		
EN 61508:2010	SIL3	SIL3
EN 62061:2005+A1:2013	SILCL3	SILCL3
EN ISO 13849-1:2008	PL e, Cat. 4	PL e, Cat. 4
PFH _o Relay output	2.74 × 10 ⁻⁹	2.00 × 10 ⁻⁹
PFH _o Transistor output	-	1.5 × 10 ⁻⁹
Electrical data		
Power supply	+24 VDC ± 15%	
Max. switching capacity		Relay output (Q1, Q11)
AC-1	250 VAC / 6 A / 1500 VA	250 V / 2 A
AC-15	240 VAC / 2 A	250 V / 2 A
DC-1	24 VDC / 6 A / 150 W	50 V / 2 A
DC-13	24 VDC / 1 A	24 V / 2 A
Number of sensors		
Max. number of Eden DYN or Tina units per input	30	10
Total max. cable length (depending on the number of Eden/Tina units)	1000 m	500 m
Max. number of Spot 10 per input	6	1
Total max. cable length (depending on the number of Spot 10)	600 m	100 m
Operating temperature	-10 °C to +55 °C	

More information

For more information, e.g. the complete technical information, see product manual for:

Vital 1: [2TLC172156M0201](#)

Vital 2/Vital 3: [2TLC172219M0201](#)

Dimension drawings

Vital

Vital 1

2

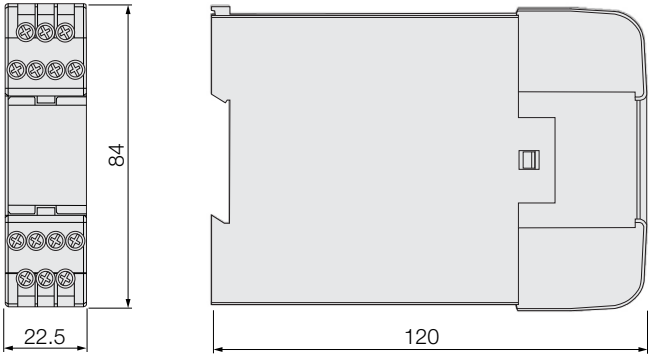

Vital 2/Vital 3

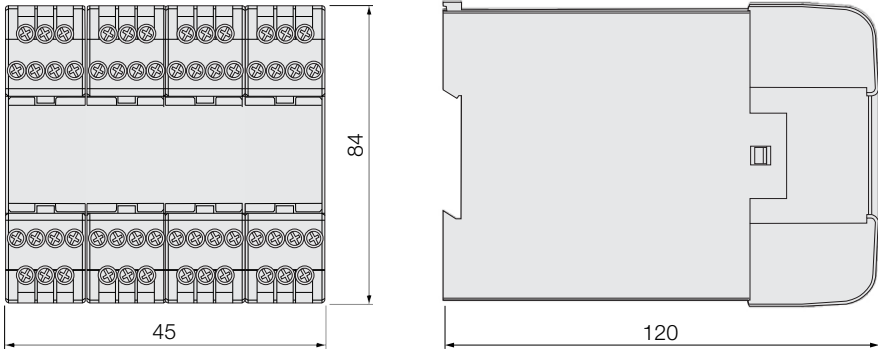

All dimensions in mm

Safety relay Sentry

2

The Sentry safety relays are powerful and easy to use safety relays, suitable for all common types of safety applications.

The Sentry series contains basic models for simple applications and easy output expansion, as well as highly flexible models with extremely accurate timer functions.

Sentry safety relays are used in both simple and more advanced safety solutions when safety devices need to be monitored according to the requirements of functional safety standards.

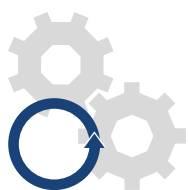

Continuous operation

LEDs and display

3-color LEDs allow for more status messages and simplify troubleshooting. Models with display offer preset configurations and extensive fault information.

Advanced timer functions

Timer functions with an accuracy of $\pm 1\%$ minimize unnecessary downtime.

Multi-reset

The multi-reset function enables reset of up to 10 Sentry safety relays using just one reset button.



Optimized logistics

Universal models

A single safety relay for all common safety applications reduces stock and saves warehouse space.

Multi-voltage

Multi-voltage models offer more flexibility and less stock.

Compact size

All models are only 22.5 mm wide, even models with 2 NO + 2 NO outputs.



Easy to install

Detachable terminal blocks

Detachable terminal blocks speed up connection and replacement.

Switch for reset selection

Manual or automatic reset easily selectable by switch.

Powerful outputs

Powerful outputs allow to drive larger contactors and simplify installation by saving the use of an intermediary contactor.

Applications

Sentry

Monitoring of safety devices

Sentry safety relays make it easy to reach the required level of safety when monitoring safety devices like emergency stop buttons, door switches, light guards, etc.



Expansion of safety outputs

Sentry expansion modules are used to increase the number of safety outputs of a safety control module in order to control more machinery.

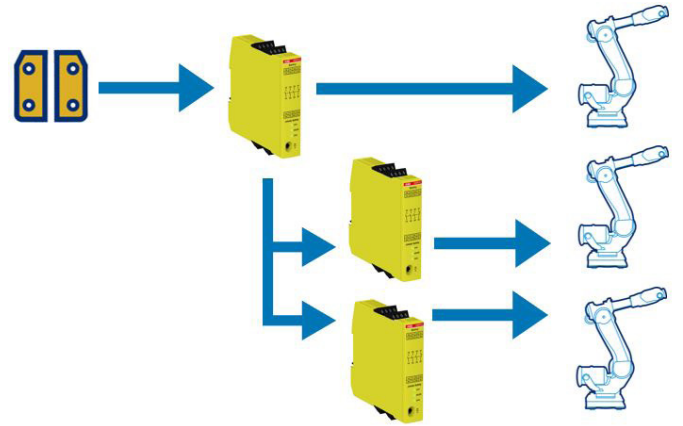

Features

Sentry

2

Timer functions with an accuracy of $\pm 1\%$

Several timer functions are available: On/Off-delay, time bypass and time reset.

On/Off-delay are used to postpone the activation/deactivation of the safety outputs with a preset time delay. This is used in e.g. Category 1 stops.

Time bypass activates the safety outputs for a maximum pre-defined time when the safety inputs are closed. Inching is an example of application.

Time reset activates the safety outputs for a maximum pre-defined time when the safety inputs are opened. Pre-reset is an example of application.

An accuracy of $\pm 1\%$ allows a very precise time to be set in order to increase safety and minimize unnecessary downtime.

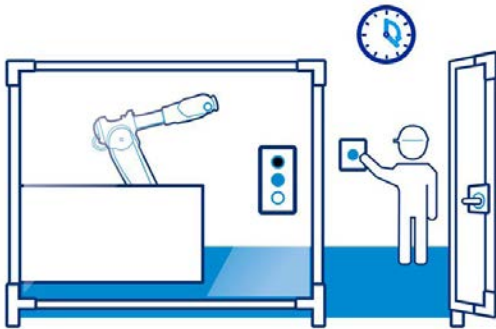

Multi-reset

The multi-reset function enables reset of up to 10 Sentry safety relays using just one reset light-button. This simplifies connection, minimizes cabling and unnecessary downtime. The multi-reset function is available for all +24 VDC Sentry models offering manual reset.

Light-button function

The light-button function is used for the multi-reset function, but can also be used for a standard reset button.

The function of the LED in the light-button is the following:

- on** - at least one input is not accepted
- flashing** - all inputs are accepted, reset possible
- off** - all inputs accepted, reset performed, outputs active

Note: if an input is accepted it means that the door is closed, the light curtain is not interrupted, etc.



Configurable models with display

The models with display are configurable and the user can choose between preset configurations and a custom configuration that can be protected by password.

Faster troubleshooting with display

The display minimizes troubleshooting by giving extensive information about internal faults, I/O faults, system faults, function faults and a log of the last 10 errors.



Switch for selection of the reset function

All models can be used in automatic reset and some models allow to choose manual reset, either by switch or by configuration, which simplifies connection. In order to prevent mistakes, it is not possible to change reset function during operation by just flipping the switch.



Powerful outputs

The outputs have a switching capacity of up to 6A DC-13. This allows Sentry to drive larger contactors and saves the use of an intermediary contactor.

Delayed outputs

Some Sentry models have delayed outputs in order to e.g. give a machine time to apply breaking force before power is disconnected.

For models with 2 NO + 2 NO outputs, it is only the second pair of NO outputs that is delayed.

For models with 3 NO + 1 NC, all outputs are delayed.

Single function or universal models

Sentry **SSR** models are single function safety relays designed for a specific application such as 1 and 2 channel devices, OSSD devices or two-hand devices.

Sentry **USR** models are universal safety relays. They are capable of handling most types of applications and safety devices, i.e. 1 and 2 channel devices, OSSD-devices, two-hand devices and contact mats/bumpers/edges. This means that only one type of relay is necessary as a spare, which reduces stock and saves warehouse space.

Ordering information

Sentry



2TLC17204W0201

BSR10



2TLC17204W0201

SSR32



2TLC17203W0201

USR10



2TLC10019F0201

S30A

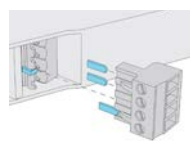

2TLC10020F0201

S30B

Ordering details

Expansion	Safety devices						Test/Reset	Safety relay outputs				Timer function	Feature	Power supply	Type	Order code			
Expansion of safety controller outputs	1 channel	2 channels with equivalent contacts	2 channels with antivalent contacts	OSSD outputs / PNP outputs	Contact mats, bumpers and safety edges c)	Two-hand devices	Manual reset (all models have auto reset)	Start/Test	3 NO + 1 NC	4 NO	2 NO + 2 delayed/delayable NO	4 NO + 1 NC	Off-delay 0.5 s	Off-delay 1.5 s	Advanced timer functions 0 – 999 s d)	Configurable with display	85-265 VAC / 120-375 VDC	+24 VDC	
a)	x	b)					x	x									x	BSR10	2TLA010040R0000
a)	x	b)					x		x								x	BSR11	2TLA010040R0200
a)											x						x	BSR23 ^{a)}	2TLA010041R0600
x	x	x		x			x	x									x	SSR10	2TLA010050R0000
x		x					x	x									x	SSR10M	2TLA010050R0100
						x	x	x									x	SSR20	2TLA010051R0000
						x	x	x									x	SSR20M	2TLA010051R0100
	x	x		x			x		x		x		x				x	SSR32	2TLA010052R0400
	x	x		x			x		x		x		x				x	SSR42	2TLA010053R0400
x	x	x		x				x					x	x	x	x	x	TSR10	2TLA010060R0000
x	x	x		x				x					x	x			x	TSR20	2TLA010061R0000
x		x						x					x	x			x	TSR20M	2TLA010061R0100
	x	x	x	x	x	x	x	x					x	x	x	x	x	USR10	2TLA010070R0000
	x	x	x	x	x	x	x		x				x	x	x	x	x	USR22	2TLA010070R0400

- a) These models can also be used for expansion of Pluto safe transistor outputs (-24 VDC)
- b) No monitoring of two-channel fault, i.e. max Category 3 without fault exclusion.
- c) The safety relay detects a short-circuit, not a change in resistance.
- d) Off-delay, On-delay, Time bypass or Time reset.
- e) BSR23 must be monitored by another device in order to reach higher than Category 1/PL c according to EN ISO 13849-1, for example a safety relay, a safety PLC or an Orion light guard (EDM function).

Accessories

Description	Type	Order code
Terminal block for Sentry safety relays. One piece.	S30A	2TLA010099R0000
Coding kit for terminal blocks. One kit for one Sentry relay.	S30B	2TLA010099R0100

Technical data

Sentry

Technical data

Approvals				
Conformity	CE 2006/42/EC - Machinery 2014/30/EU - EMC 2011/65/EU - RoHS EN ISO 12100:2010, EN ISO 13849-1:2015, EN 62061:2005+A2:2015, EN 62061:2005+A2:2015, EN 60664-1:2007, EN 61000-6-2:2005, EN 61000-6-4:2007, EN 61508:2010			
Functional safety data	BSR10	BSR11, BSR23	SSR10, SSR10M, SSR20, SSR20M, TSR10, TSR20, TSR20M, USR10	SSR32, SSR42, USR22
EN/IEC 61508:2010	SIL3, PFH _D = 3.0 x 10 ⁻⁹	SIL3, PFH _D = 4.1 x 10 ⁻⁹	SIL3, PFH _D = 4.9 x 10 ⁻⁹	SIL3, PFH _D = 9.3 x 10 ⁻⁹
EN/IEC 62061:2005+A1:2013	SILCL3, PFH _D = 3.1 x 10 ⁻⁹	SILCL3, PFH _D = 4.1 x 10 ⁻⁹	SILCL3, PFH _D = 4.9 x 10 ⁻⁹	SILCL3, PFH _D = 3.9 x 10 ⁻⁹
EN ISO 13849-1:2008	PL e, Cat. 4, PFH _D = 3.1 x 10 ⁻⁹	PL e, Cat. 4, PFH _D = 4.1 x 10 ⁻⁹	PL e, Cat. 4, PFH _D = 4.9 x 10 ⁻⁹	PL e, Cat. 4, PFH _D = 3.9 x 10 ⁻⁹
Note! The relays must be cycled at least once a year.				
Electrical data				
Operating voltage	+24 VDC (19.2-27.6 VDC) PELV / SELV Mains models: 85-265 VAC (50 / 60 Hz) or 120-375 VDC			
Response time at deactivation	20 ms			
Maximum switching capacity				
DC13, DC1	Up to 6 A (except relays with 2 NO + 2 NO outputs that switch 3 A)			
AC15, AC1	Up to 5 A (except relays with 2 NO + 2 NO outputs that switch 3 A)			
Mechanical data				
Operating temperature	-10 °C – 55 °C			
Humidity range	25% ... 90%			
Protection class	IP20 (enclosure/electrical cabinet must have at least an IP54)			
Mounting	35 mm DIN rail (DIN 50022)			
Minimum space between relays in the enclosure	0 mm			

More information

For more information, e.g. the complete technical information, see product manual:

Sentry [2TLC010002M0201](https://www.abb.com/Products/Relays/2TLC010002M0201)

Dimension drawing Sentry

Dimension drawing

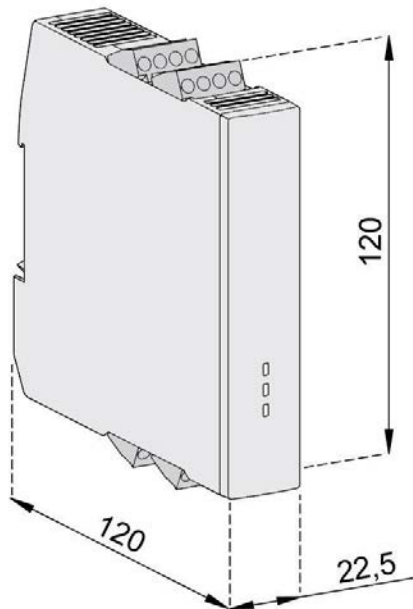

All dimensions in mm



Optical safety devices

Introduction and overview



Selection guide	3/2
Safety light curtain – Orion1 Base	3/6
Safety light curtain – Orion1 Extended	3/14
Safety light grid – Orion2 Base	3/22
Safety light grid – Orion2 Extended	3/30
Safety light grid – Orion3 Base	3/38
Safety light grid – Orion3 Extended	3/46
Safety light beam – Spot	3/54

Introduction and overview

Selection guide

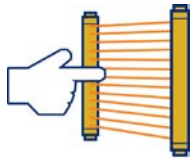
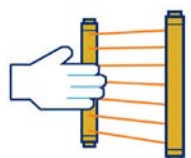
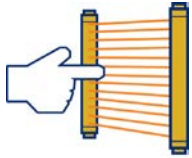
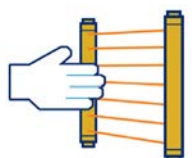

Light curtains, light guards and light beams that cover most types of applications.

3

Orion1				
Function	Light curtain, Transmitter + Receiver, Slim profile			
Image				
Type	Orion1 Base		Orion1 Extended	
Type of detection	 Finger	 Hand	 Finger	 Hand
Resolution	14 mm	30 mm	14 mm	30 mm
Protected height	15-180 cm	15-180 cm	30-180 cm	30-180 cm
Applications	Manually serviced machines with short safety distances.		Manually serviced machines with short safety distances. With advanced features like muting, blanking and cascading.	

Functions

	6 m	19 m	7 m	20 m
Range	6 m	19 m	7 m	20 m
Auto/Manual reset	x	x	x	x
EDM	x	x	x	x
Muting			x	x
Override			x	x
Integrated muting lamp				
Blanking			x	x
No dead zone			x	x
Coding			x	x
Cascading			x	x

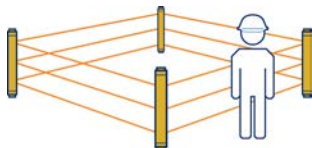
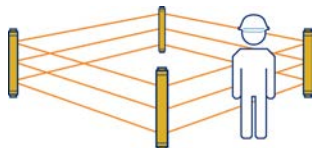
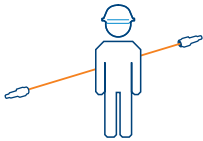
	Orion2		Orion3		Spot
Function	Light grid, Transmitter + Receiver, Slim profile		Light grid, Active + Passive units, Sturdy profile		Light beam, Transmitter + Receiver
Image					
Type	Orion2 Base	Orion2 Extended	Orion3 Base	Orion3 Extended	Spot 10
Type of detection	 Body		 Body		 Body
Resolution	2, 3 or 4 beams				1 beam
Protected height	50-120 cm				
Applications	Perimeter guarding over long distances	Perimeter guarding over long distances with muting	Perimeter guarding with one-sided connection	Perimeter guarding with one-sided connection and muting	Used in combination with other safeguards or in reduced spaces. Several spot light beams can also be combined to form a light grid.
Functions					
Range	50 m	50 m	Up to 8 m	Up to 8 m	10 m
Auto/Manual reset	x	x	x	x	
EDM	x	x	x	x	
Muting		x		x	
Override		x		x	
Integrated muting lamp		x		x	
Blanking					
No dead zone					
Coding					
Cascading					

Introduction and overview

Selection orientation

Choose the right resolution for your application

Finger detection

Light curtains with 14 mm resolution are intended for finger detection when the light guard needs to be very close to the machine in order to give the operator a good view and easy accessibility to the machine.

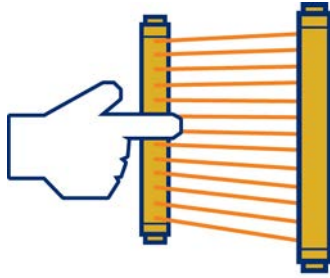

Hand detection

Light curtains with 30 mm resolution are intended for hand detection and area protection and is often a good compromise between cost and accessibility to the machine. They offer a better sensing range than finger detection light curtains, but require a slightly greater safety distance.

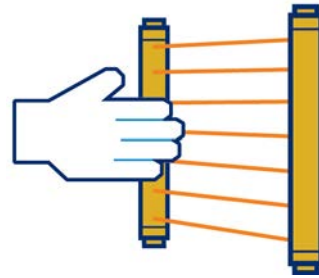

Body detection

Light grids have a resolution adapted for detection of the whole body and are intended for perimeter guarding where there is a requirement for high accessibility. They offer a very good sensing range, but require a much greater safety distance than light guards for finger and hand detection.

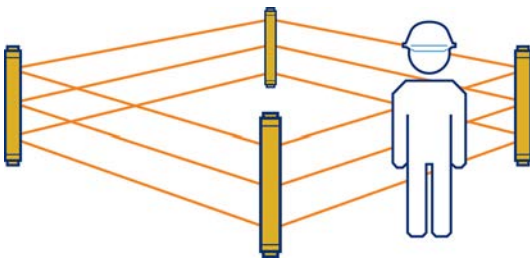

Body detection with single beam

Since it is not suitable to use a single beam as the only means of protection for preventing whole body access, single beams are often used in combination with other safeguards. They can also be used in combination with fixed structures, which restrict the openings such that it is not possible to pass the protective device without being detected.

Several Spot light beams can also be connected in series to form a light grid according to Cat. 4/PL e. Spot belongs to the DYNlink system and must be connected to Pluto or Vital.

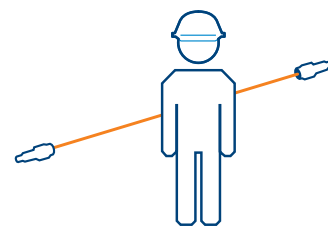

Introduction and overview

Standards

Resolution and safety distance

The optical safety device must be installed so that no-one can reach the hazardous area without first passing through the detection zone of the light guard. The distance from the hazardous area to the detection zone of the optical safety device must be large enough in order for the machine to have time to stop before someone can reach the hazardous area. This distance is called the safety distance, and it shall be calculated using the formula from EN ISO 13855.

The safety distance is influenced by the distance between each beam in the light guard. The closer the beams are together, the smaller the safety distance can be, which is why light curtains for finger detection can be placed much closer to the hazardous area than light grids for body detection.

Safety light curtain

Orion1 Base

Orion1 Base is an easy to use light curtain with compact dimensions and two resolutions for detection of fingers and hands.

3

Light curtains are usually used closed to the hazardous zone when repeated access to the machine is necessary, for example manually serviced machines.

Light curtains can also be used to limit work zones inside the hazardous area and be mounted horizontally for area protection.



Cost effective solution

No more functions than necessary

Orion1 Base comes with a minimum of advanced functionalities to save cost.

Minimized cabling

A local reset button can be connected directly to the light curtain. In this way there is no need for a cable between the reset button and the electrical cabinet or for an extra control module.

External device monitoring

Each light curtain can monitor the actuators without any extra control module (EDM function).



Continuous operation

Visible alignment level

Since the alignment level is displayed, the alignment can be improved before the occurrence of an unwanted stop.

Extensive error indication

Extensive error indication reduces troubleshooting time.

Protection against harsh environment

Protective tubes and lens shields protect the devices in harsh environments.



Easy to install

Easy to align

Alignment help and a wide angle within the limits of a Type 4 device facilitate alignment. Rotation brackets also simplify alignment.

Easy to connect

M12 connectors speed up cabling.

Applications and features

Orion1 Base

Applications

Vertical mounting

When using standard vertical mounting the light guard can be placed close to the hazard zone. This is suitable for applications where repeated access to the machine is necessary, e.g. manually serviced machines.

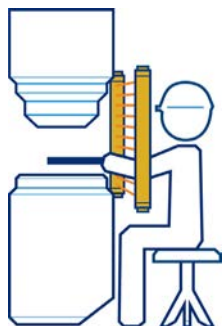

Horizontal mounting

Horizontal mounting is mainly used for area protection and limitation of work zones.



Features

Finger detection

A 14 mm resolution is intended for finger detection when the light guard needs to be very close to the machine in order to give the operator a good view and easy accessibility to the machine. A 14 mm resolution enables a sensing range of 6 m.

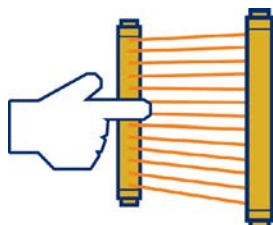

Hand detection

A 30 mm resolution is intended for hand detection and area protection and is a good compromise between cost and accessibility to the machine. A 30 mm resolution enables a sensing range of 19 m.

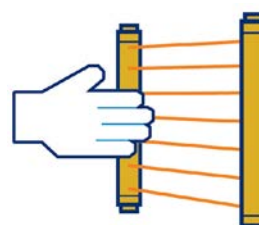

Local reset

A local reset button is connected directly to the light guard instead of to the safety control module in the electrical cabinet. This saves safety relays/PLC inputs and minimizes cabling to the electrical cabinet. Clever accessories makes the connection easier.

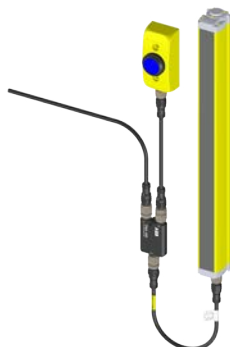

EDM

External Device Monitoring is a feature allowing the light guard to supervise the actuators in simpler applications, eliminating the need for a safety relay or programmable safety controller.

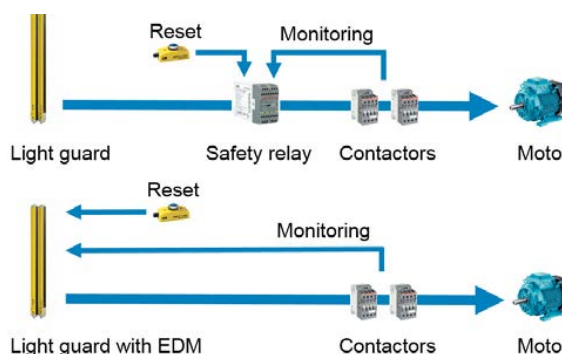

Safety light curtain

Orion1 Base

3



Orion1 Base

Ordering details

Detection (Resolution mm)	Protected height mm	Type (Transmitter + receiver)	Order code	
Finger (14)	150	Orion1-4-14-015-B	2TLA022300R0000	
	300	Orion1-4-14-030-B	2TLA022300R0100	
	450	Orion1-4-14-045-B	2TLA022300R0200	
	600	Orion1-4-14-060-B	2TLA022300R0300	
	750	Orion1-4-14-075-B	2TLA022300R0400	
	900	Orion1-4-14-090-B	2TLA022300R0500	
	1050	Orion1-4-14-105-B	2TLA022300R0600	
	1200	Orion1-4-14-120-B	2TLA022300R0700	
	1350	Orion1-4-14-135-B	2TLA022300R0800	
	1500	Orion1-4-14-150-B	2TLA022300R0900	
	1650	Orion1-4-14-165-B	2TLA022300R1000	
	1800	Orion1-4-14-180-B	2TLA022300R1100	
	Hand (30)	150	Orion1-4-30-015-B	2TLA022302R0000
		300	Orion1-4-30-030-B	2TLA022302R0100
450		Orion1-4-30-045-B	2TLA022302R0200	
600		Orion1-4-30-060-B	2TLA022302R0300	
750		Orion1-4-30-075-B	2TLA022302R0400	
900		Orion1-4-30-090-B	2TLA022302R0500	
1050		Orion1-4-30-105-B	2TLA022302R0600	
1200		Orion1-4-30-120-B	2TLA022302R0700	
1350		Orion1-4-30-135-B	2TLA022302R0800	
1500		Orion1-4-30-150-B	2TLA022302R0900	
1650		Orion1-4-30-165-B	2TLA022302R1000	
1800		Orion1-4-30-180-B	2TLA022302R1100	

Spare parts (included when ordering Orion)

Description	Type	Order code
4 standard brackets for Orion1 & Orion2	JSM Orion01	2TLA022310R0000



JSM Orion01

Accessories Orion1 Base



2TLC172016RF0201

Orion Laser pointer



2TLC172783F0201

JSM Orion03



2TLC172367F0201

Smile 11 RB



2TLC172012V0201

M12-3R



2TLC172477F0201

Tina 10C

Accessories

Mounting accessories

Description	Type	Order code
Orion Test Piece 14 mm	Orion TP-14	2TLA022310R5200
Orion Test Piece 30 mm	Orion TP-30	2TLA022310R5300
Orion Laser pointer	Orion Laser	2TLA022310R5000
Screw MC6S M5x12 to be used with T-nut JSM M5B for mounting Orion on Quick-Guard	Screw MC6S	2TLJ041012R0200
JSM M5B Special T-nut M5 to be used with screw MC6S for mounting Orion on Quick-Guard	T-nut JSM M5B	2TLA040035R0400
4 rotation brackets for Orion1 Base	JSM Orion03	2TLA022310R0100
Kit for mounting of Orion1 & Orion2 in Stand (4 pieces for lengths shorter than 1200 mm)	JSM Orion06	2TLA022310R0400
Kit for mounting of Orion1 & Orion2 in Stand (6 pieces for lengths of 1200 mm or more)	JSM Orion07	2TLA022310R0500
Kit for mounting of Orion1 Mirror in Stand	JSM Orion11	2TLA022310R0900
Orion Plate kit for adjustment of protective stand	Orion Stand Plate	2TLA022312R5000
Deviating mirror to be mounted in Orion Stand with one kit JSM Orion11	Orion1 Mirror*	
Protective stand	Orion Stand*	
Protective tube	Orion WET*	
Lens shield	Orion Shield*	

Connection accessories

Smile reset button with NO contact	Smile 11 RA	2TLA030053R0000
Smile reset button with NO contact for Pluto	Smile 11 RB	2TLA030053R0100
Smile reset button with NO contact for Orion1 Base	Smile 11R01	2TLA022316R3000
Y-connector for series connection of DYNlink devices with M12-5 connectors, e.g. Eden	M12-3A	2TLA020055R0000
Y-connector for connection of a Smile reset button to Orion	M12-3R	2TLA022316R0000
Y-connector for easy connection of a transmitter	M12-3D	2TLA020055R0300
Adaptation of OSSD to DYNlink. Two M12-5 connectors.	Tina 10A	2TLA020054R1200
Adaptation of OSSD to DYNlink with possibility to connect a local reset button. Three M12-5 connectors.	Tina 10B	2TLA020054R1300
Adaptation of OSSD to DYNlink with possibility to power the transmitter. Three M12-5 connectors.	Tina 10C	2TLA020054R1600
Safe AS-i input slave for OSSD, 3 non safe inputs and 1 reset input	Urax-D1R	2TLA020072R0500

*These accessories are available in different sizes.

For more information see:

Orion1 Mirror [2TLC172058L0201](#), Orion Stand [2TLC172059L0201](#), Orion WET [2TLC172061L0201](#), Orion Shield [2TLC172071L0201](#)

For more information about the connection accessories, please see:

Orion connection accessories [2TLC172101L0201](#)

How to choose correct reset button

Local or global reset	Adaption to DYNlink	Safety control module	Type	Useful connection accessories
Local reset button connected to the light guard	Yes	Vital or Pluto	Smile 11R01	Tina 10B: OSSD to DYNlink + local reset button M12-3A: Serial connection of DYNlink
(Orion in manual reset mode)	No	Any safety control module compatible with light guard	Smile 11R01	M12-3R: Easy connection of a local reset button
Global reset button connected to the control module	Yes	Vital	Smile 11 RA	Tina 10A: OSSD to DYNlink Tina 10C: OSSD to DYNlink + supply to transmitter
(Orion in automatic reset mode)		Pluto	Smile 11 RB	Tina 10A: OSSD to DYNlink Tina 10C: OSSD to DYNlink + supply to transmitter
	No	Any safety control module compatible with light guard	Smile 11 RA**	-

* The ABB Jokab Safety DYNlink solution offers the following advantages:

- Serial connection of safety devices while maintaining PLe/cat. 4, up to 25 Tina 10 per Vital and up to 5 Tina 10 per Pluto input.
- Only one safety input of the Pluto instead of two with the standard OSSD outputs.

** Smile 11 RA has one NO contact, which is the most common for reset buttons. Please check what is requested for the chosen safety control module.

Cables and connectors

Orion1 Base

3



M12-C61

2TLC17295FR0201



M12-C61HE

2TLC010003F0201



M12-C334

2TLC172931F0201

Cable with connectors

Connector	Female/male	Length	Special feature	Type	Order code
M12-5	Female	6 m		M12-C61	2TLA020056R0000
			Harsh environment, halogen free	M12-C61HE	2TLA020056R8000
		10 m		M12-C101	2TLA020056R1000
			Harsh environment, halogen free	M12-C101HE	2TLA020056R8100
		20 m		M12-C201	2TLA020056R1400
	Female + male	0.3 m		M12-C0312	2TLA020056R5800
		0.06 m		M12-C00612	2TLA020056R6300
		1 m		M12-C112	2TLA020056R2000
		3 m		M12-C312	2TLA020056R2100
		6 m		M12-C612	2TLA020056R2200
		10 m		M12-C1012	2TLA020056R2300
M12-8	Female	6 m		M12-C63	2TLA020056R3000
		10 m		M12-C103	2TLA020056R4000
		20 m		M12-C203	2TLA020056R4100
	Female + male	0.06 m		M12-C00634 ¹	2TLA020056R6400
		1 m		M12-C134	2TLA020056R5000
		3 m		M12-C334	2TLA020056R5100
M12-8 male + female	Female + male	0.2		M12-CTO1BA ¹	2TLA022315R3000
M12-8 male + female	Female + male	0.2		M12-CTO1BM ²	2TLA022315R3100
M12-8 female - M12-5 male	Female + male	1		M12-CTURAX-01B ³	2TLA022315R3300

1) M12-CTO1BA can be used for:

- connection of Orion1 Base to Tina 10A/C
 - replacement of Focus II in automatic reset with Orion in automatic reset.
- The EDM function should be deactivated in all cases.

2) M12-CTO1BM can be used for:

- connection of Orion1 Base to Tina 10B or M12-3R for use of a local reset button, for example Smile 11ROx
 - replacement of Focus II in manual reset with Orion in manual reset.
- The EDM function should be deactivated in all cases.

3) M12-CTURAX-01B is used for:

- the connection of Orion1 Base to URAX-D1R.
- The light guard is automatically configured in automatic reset and the EDM function should be deactivated.

Separate cables and connectors

Description	Type	Order code
Connectors		
M12-5 pole female, straight	M12-C01	2TLA020055R1000
M12-5 pole male, straight	M12-C02	2TLA020055R1100
M12-8 pole female, straight	M12-C03	2TLA020055R1600
M12-8 pole male, straight	M12-C04	2TLA020055R1700



M12-C01

2TLC17295FR0201



C5 cable

2TLC010038F0201

Cable with 5 conductors

10 m cable with 5 x 0.34 shielded conductors	C5 cable 10 m	2TLA020057R0001
50 m cable with 5 x 0.34 shielded conductors	C5 cable 50 m	2TLA020057R0005
100 m cable with 5 x 0.34 shielded conductors	C5 cable 100 m	2TLA020057R0010
200 m cable with 5 x 0.34 shielded conductors	C5 cable 200 m	2TLA020057R0020
500 m cable with 5 x 0.34 shielded conductors	C5 cable 500 m	2TLA020057R0050

Cable with 8 conductors

50 m cable with 8 x 0.34 shielded conductors	C8 cable 50 m	2TLA020057R1005
100 m cable with 8 x 0.34 shielded conductors	C8 cable 100 m	2TLA020057R1010
200 m cable with 8 x 0.34 shielded conductors	C8 cable 200 m	2TLA020057R1020
500 m cable with 8 x 0.34 shielded conductors	C8 cable 500 m	2TLA020057R1050

Connection examples

Orion1 Base

Orion with Tina 10A/C

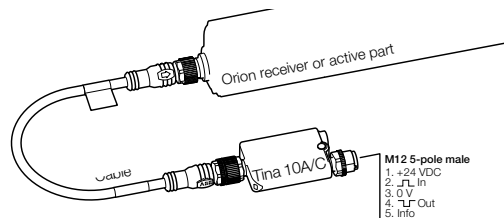

Without local reset button

Connection to the ABB Jokab Safety DYNlink signal via Tina 10 A/C. To be used with Vital safety control module or Pluto programmable safety controller.

Reset to Orion with Tina 10B

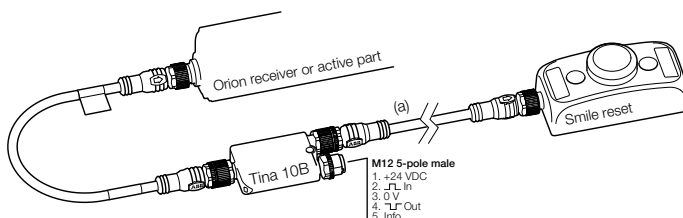

With local reset button

Connection to the ABB Jokab Safety DYNlink signal via Tina 10B. To be used with Vital safety control module or Pluto programmable safety controller.

Reset to Orion with M12-3R

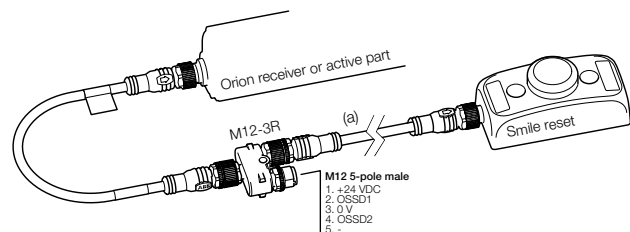



Connection of a local reset button via M12-3R.

Technical data

Orion1 Base

Technical data

Approvals	 
Conformity	CE 2006/42/EC - Machinery 2004/108/EC - EMC EN ISO 13849-1:2008, EN 62061:2005+A1:2013, EN 61496-1:2013, EN 61496-2, EN 61508-1:2010, EN 61508-2:2010, EN 61508-3:2010, EN 61508-4:2010
Functional safety data	
EN 61508:2010	SIL3, PFH _D = 2.64 x 10 ⁻⁹
EN 62061:2005+A1:2013	SILCL3, PFH _D = 2.64 x 10 ⁻⁹
EN ISO 13849-1:2008	PL e, Cat. 4, PFH _D = 2.64 x 10 ⁻⁹
Electrical data	
Power supply	+24 VDC ± 20%
Power consumption, transmitter	1.5 W max
Power consumption, receiver	4 W max (without load)
Outputs	2 PNP
Short-circuit protection	1.4 A max
Output current	0.5 A max / output
Output voltage – ON	V _{dd} -1 V min
Output voltage – OFF	0.2 V max
Capacitive load	2.2 µF at +24 VDC max
Cable length (for power supply)	50 m max
Connectors	M12-4 pole male on transmitter (compatible with M12-5 pole female) M12-8 pole male on receiver
Optical data	
Light emission (λ)	Infrared, LED (950 nm)
Resolution	14 or 30 mm
Operating distance	0.2...19 m for 30 mm 0.2...6 m for 14 mm
Ambient light rejection	According to IEC-61496-2:2013
Mechanical data	
Operating temperature	0...+ 55 °C
Storage temperature	- 25...+ 70 °C
Humidity range	15...95% (no condensation)
Protection class	IP65 (EN 60529:2000)
Weight	1.3 kg / meter for each single unit
Housing material	Painted aluminium (yellow RAL 1003)
Front glass material	PMMA
Cap material	PC MAKROLON

More information

For more information, e.g. the complete technical information, please see product manual for:

Orion1 Base [2TLC172287M0201](#)

Dimension drawings Orion1 Base

Orion1 Base

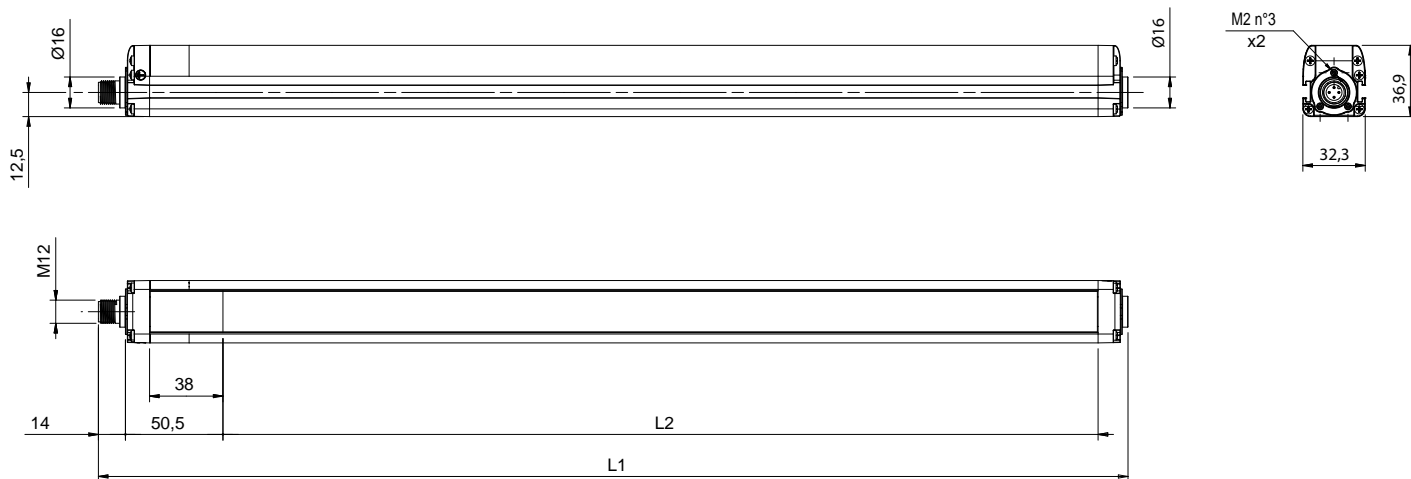

All dimensions in mm

Dimension

Protected height mm	L1 mm	L2 mm	Type
150	233.3	153.3	Orion1-4-xx-015-B
300	383.2	303.2	Orion1-4-xx-045-B
450	533.2	453.3	Orion1-4-xx-045-B
600	683.3	603.2	Orion1-4-xx-060-B
750	833.2	753.3	Orion1-4-xx-075-B
900	983.2	903.2	Orion1-4-xx-090-B
1050	1133.2	1053.2	Orion1-4-xx-105-B
1200	1283.2	1203.3	Orion1-4-xx-120-B
1350	1433.2	1353.2	Orion1-4-xx-135-B
1500	1583.3	1503.3	Orion1-4-xx-150-B
1650	1733.3	1653.3	Orion1-4-xx-165-B
1800	1883.3	1803.3	Orion1-4-xx-180-B

xx = Resolution

Safety light curtain Orion1 Extended

Orion1 Extended is an easy to use light curtain with compact dimensions. It has two resolutions for detection of fingers and hands, and comes with advanced features like cascading, muting and blanking.

3

Light curtains are usually placed closed to the hazardous zone when repeated access to the machine is necessary, for example manually serviced machines.



Cost effective solution

Integrated muting function

Muting sensors are connected directly to the light grid, with no need for a remote muting module.

No dead zones

The light beams cover all of the profile length, without the usual dead zones at the ends requiring extra mechanical guards.

Easy serial connection

Cascading with the standard units: no separate slave or master units.



Easy to install

Easy to align

Alignment help and a wide angle within the limits of a Type 4 device facilitate installation.

Easy to connect

Cables with M12 connectors speeds up connection.

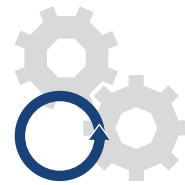

Continuous operation

Reduced downtime

Extensive error indication reduces troubleshooting time.

Interference protection

Protection against mutual interference with coding.

Features

Orion1 Extended

Finger detection

A 14 mm resolution is intended for finger detection when the light guard needs to be very close to the machine in order to give the operator a good view and easy accessibility to the machine. A 14 mm resolution enables a sensing range of 7 m.

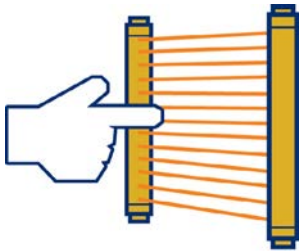

Hand detection

A 30 mm resolution is intended for hand detection and area protection and is a good compromise between cost and accessibility to the machine. A 30 mm resolution enables a sensing range of 20 m.

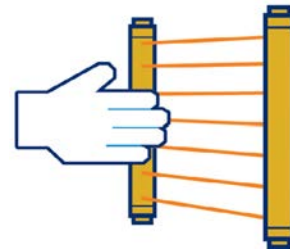

Blanking

The blanking function allows to define a number of beams that can be constantly interrupted without stopping the machine. In this way a fixed material or a cable is allowed in the protected field, but a hand interrupting an extra beam would stop the machine. With floating blanking, the object, for ex. the cable, can move within the protected field.

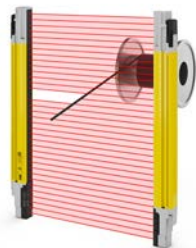

No dead zones

A special feature of Orion1 Extended is that the light beams cover all of the profile length, without any dead zones. This enables to place it inside openings, instead of having a larger light guard in front of an opening.



Cascading

All Orion1 Extended units can be connected in series (cascaded) to easily create a suitable light curtain setup with no special units needed.



Muting

By connecting muting sensors to the light guard, it can distinguish material from persons and allow the material to pass through an opening but not persons.

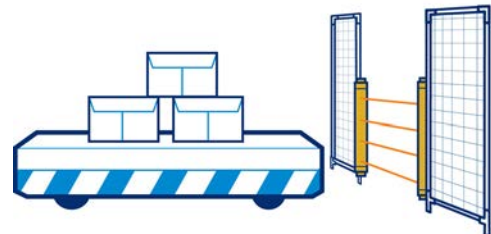

Local reset

A local reset button is connected directly to the light guard instead of to the safety control module in the electrical cabinet. This saves safety relays/programmable inputs and minimizes cabling to the electrical cabinet.

EDM

External Device Monitoring is a feature allowing the light guard to supervise the actuators in simpler applications, eliminating the need for a safety relay or programmable safety controller.

Ordering information

Orion1 Extended

3



2TLC17278FF0201

Orion1 Extended

Ordering details

Resolution mm	Protected height mm	Type (Transmitter + receiver)	Order code
Finger (14)	300	Orion1-4-14-030-E	2TLA022301R0100
	450	Orion1-4-14-045-E	2TLA022301R0200
	600	Orion1-4-14-060-E	2TLA022301R0300
	750	Orion1-4-14-075-E	2TLA022301R0400
	900	Orion1-4-14-090-E	2TLA022301R0500
	1050	Orion1-4-14-105-E	2TLA022301R0600
	1200	Orion1-4-14-120-E	2TLA022301R0700
	1350	Orion1-4-14-135-E	2TLA022301R0800
	1500	Orion1-4-14-150-E	2TLA022301R0900
	1650	Orion1-4-14-165-E	2TLA022301R1000
	1800	Orion1-4-14-180-E	2TLA022301R1100
Hand (30)	300	Orion1-4-30-030-E	2TLA022303R0100
	450	Orion1-4-30-045-E	2TLA022303R0200
	600	Orion1-4-30-060-E	2TLA022303R0300
	750	Orion1-4-30-075-E	2TLA022303R0400
	900	Orion1-4-30-090-E	2TLA022303R0500
	1050	Orion1-4-30-105-E	2TLA022303R0600
	1200	Orion1-4-30-120-E	2TLA022303R0700
	1350	Orion1-4-30-135-E	2TLA022303R0800
	1500	Orion1-4-30-150-E	2TLA022303R0900
	1650	Orion1-4-30-165-E	2TLA022303R1000
	1800	Orion1-4-30-180-E	2TLA022303R1100

Spare parts (included when ordering Orion)

Description	Type	Order code
4 standard brackets for Orion1 & Orion2	JSM Orion01	2TLA022310R0000



2TLC17278FF0201

JSM Orion01

Accessories

Orion1 Extended



OMC1

2TLC172016W0201

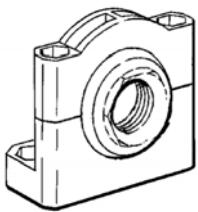

JSM 64

2TLC10338F02011



Orion Laser pointer

2TLC172816F0201

Connection accessories

Connection accessories

Description	Type	Order code
Connection box for two or four muting sensors	OMC1	2TLA022316R2000
Retroreflex photoelectric sensor	Mute R2	2TLA022044R0500
Adjustable mounting bracket for M18 sensors (e.g. Mute R2 and Spot 10).	JSM 64	2TLA040007R0200
Reflector diameter 63 mm	Reflect 1	2TLA022044R2000
Reflector diameter 82 mm	Reflect 2	2TLA022044R3000
Smile reset button with NO contact	Smile 11 RA	2TLA030053R0000
Smile reset button with NO contact for Pluto	Smile 11 RB	2TLA030053R0100

Mounting accessories

Orion Test Piece 14 mm	Orion TP-14	2TLA022310R5200
Orion Test Piece 30 mm	Orion TP-30	2TLA022310R5300
Orion Laser pointer	Orion Laser	2TLA022310R5000
Screw MC6S M5x12 to be used with T-nut JSM M5B for mounting Orion on Quick-Guard	Screw MC6S	2TLJ041012R0200
JSM M5B Special T-nut M5 to be used with screw MC6S for mounting Orion on Quick-Guard	T-nut JSM M5B	2TLA040035R0400
Kit for mounting of Orion1 & Orion2 in Stand (4 pieces for lengths shorter than 1200 mm)	JSM Orion06	2TLA022310R0400
Kit for mounting of Orion1 & Orion2 in Stand (6 pieces for lengths of 1200 mm or more)	JSM Orion07	2TLA022310R0500
Kit for mounting of Orion1 Mirror in Stand	JSM Orion11	2TLA022310R0900
Orion Plate kit for adjustment of protective stand	Orion Stand Plate	2TLA022312R5000
Deviating mirror to be mounted in Orion Stand with one kit JSM Orion11	Orion1 Mirror*	
Protective stand	Orion Stand*	

*These accessories are available in different sizes.

For more information see:

Orion1 Mirror [2TLC172058L0201](#)

Orion Stand [2TLC172059L0201](#)

For more information about the connection accessories, please see:

Orion connection accessories [2TLC172101L0201](#)

Cables

Orion1 Extended

3



M12-C61

2TLC17295F0201



M12-C61HE

2TLC01003F0201



M12-C2012

2TLC172935F0201

Cables with connectors

Muting to be used	Necessary transmitter/receiver cable	Suitable cable between transmitter/receiver cable and el-cabinet	Length	Special feature	Type	Order code
Yes	Transmitter M12-C02PT2T	M12-5 female single ended, to e.g. el-cabinet	6 m	Harsh environment, halogen free	M12-C61	2TLA020056R0000
			6 m		M12-C61HE	2TLA020056R8000
			10 m		M12-C101HE	2TLA020056R8100
			10 m		M12-C101	2TLA020056R1000
			20 m		M12-C201	2TLA020056R1400
	Receiver M12-C02PT62RM	M12-5 male + female, to e.g. OMC1	0.06 m	M12-C00612	2TLA020056R6300	
			0.3	M12-C0312	2TLA020056R5800	
			1 m	M12-C112	2TLA020056R2000	
			3 m	M12-C312	2TLA020056R2100	
			6 m	M12-C612	2TLA020056R2200	
			10 m	M12-C1012	2TLA020056R2300	
			16 m	M12-C1612	2TLA020056R5400	
			20 m	M12-C2012	2TLA020056R2400	
			M12-12 female single ended, to e.g. el-cabinet	6 m	M12-C65	2TLA020056R7200
				10 m	M12-C105	2TLA020056R7300
20 m	M12-C205	2TLA020056R7500				
No	Transmitter M12-C02PT2T	M12-5 female single ended, to e.g. el-cabinet	6 m	Harsh environment, halogen free	M12-C61	2TLA020056R0000
			6 m		M12-C61HE	2TLA020056R8100
			10 m		M12-C101HE	2TLA020056R5400
			10 m		M12-C101	2TLA020056R1000
			20 m		M12-C201	2TLA020056R1400
	Receiver M12-C02PT6RB	M12-12 female single ended, to e.g. el-cabinet	6 m	M12-C65	2TLA020056R7200	
			10 m	M12-C105	2TLA020056R7300	
			20 m	M12-C205	2TLA020056R7500	

Separate cables and connectors

Description	Type	Order code
Connectors		
M12-5 pole female, straight	M12-C01	2TLA020055R1000
M12-5 pole male, straight	M12-C02	2TLA020055R1100



M12-C01

2TLC17265F0201



C5 cable

2TLC010038F0201

Cable with 5 conductors

10 m cable with 5 x 0.34 shielded conductors	C5 cable 10 m	2TLA020057R0001
50 m cable with 5 x 0.34 shielded conductors	C5 cable 50 m	2TLA020057R0005
100 m cable with 5 x 0.34 shielded conductors	C5 cable 100 m	2TLA020057R0010
200 m cable with 5 x 0.34 shielded conductors	C5 cable 200 m	2TLA020057R0020
500 m cable with 5 x 0.34 shielded conductors	C5 cable 500 m	2TLA020057R0050

Special cables for Orion1 Extended

Description	Length	Type	Order code
Transmitter cable for Orion1 Extended. M12-5 male connector.	0.2 m	M12-C02PT2T	2TLA022315R0100
Receiver cable for Orion1 Extended when no muting. M12-12 male connector.	0.2 m	M12-C02PT6RB	2TLA022315R0200
Receiver cable for Orion1 Extended when muting. M12-5 male connector (for muting sensors) and M12-12 male connector.	0.2 m	M12-C02PT62RM	2TLA022315R0300
Cascade cable for Orion1 Extended	1 m	PT-C1PT	2TLA022315R1000
Cascade cable for Orion1 Extended	0.5 m	PT-C05PT	2TLA022315R1100
Cascade cable for Orion1 Extended	0.05 m	PT-C005PT	2TLA022315R1200



M12-C02PT2T

Connection example

Orion1 Extended

Connection of the muting sensors with M12-C02PT62RM and OMC1

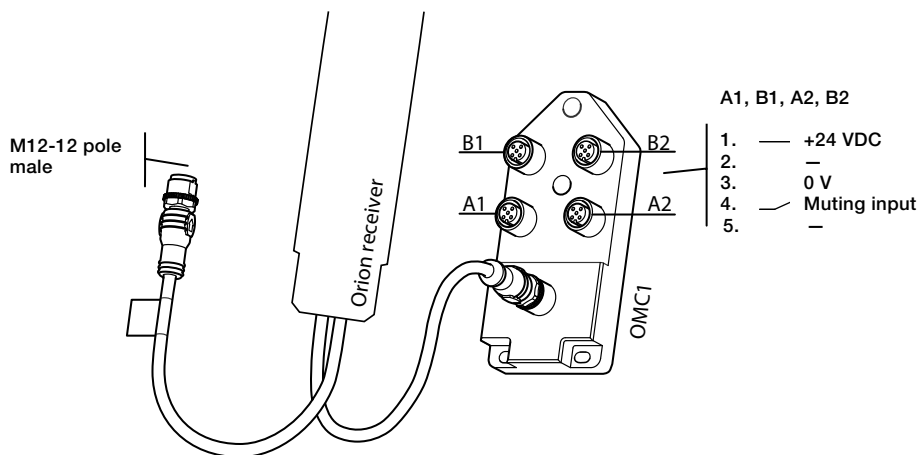



NB: Cable with M12-5 male + female connectors shall be used between muting sensors and OMC1 inputs A1, B1, A2, B2.

Technical data

Orion1 Extended

Technical data

Approvals	 
Conformity	CE 2006/42/EC - Machinery 2004/108/EC - EMC EN ISO 13849-1:2008, EN 62061:2005/A1:2013, EN 61496-1:2013, EN 61496-2, EN 61508-1:2010, EN 61508-2:2010, EN 61508-3:2010, EN 61508-4:2010
Functional safety data	
EN 61508:2010	SIL3, PFH _D = 2.64 x 10 ⁻⁹
EN 62061:2005+A1:2013	SILCL3, PFH _D = 2.64 x 10 ⁻⁹
EN ISO 13849-1:2008	PL e, Cat. 4, PFH _D = 2.64 x 10 ⁻⁹
Electrical data	
Power supply	+24 VDC ± 20%
Power consumption, Transmitter	3 W max
Power consumption, Receiver	5 W max (without load)
Outputs	2 PNP
Short-circuit protection	1.4 A max
Output current	0.5 A max / output
Output voltage – ON	V _{dd} -1 V min
Output voltage – OFF	0.2 V max
Capacitive load	2.2 µF at +24 VDC max
Current for external lamp	20 mA min; 200 mA max
Cable length (for power supply)	50 m max
Connectors	M12-4 pole male on transmitter (compatible with M12-5 pole female) M12-8 pole male on receiver
Optical data	
Light emission (λ)	Infrared, LED (950 nm)
Resolution	14 or 30 mm
Operating distance	0.2...20 m for 30 mm 0.2...7 m for 14 mm
Ambient light rejection	According to IEC-61496-2:2013
Mechanical data	
Operating temperature	0...+ 50 °C
Storage temperature	- 25...+ 70 °C
Humidity range	15...95% (no condensation)
Protection class	IP65 (EN 60529:2000)
Weight	1.35 kg / meter for each single unit
Housing material	Painted aluminium (yellow RAL 1003)
Front glass material	PMMA
Cap material	PBT Valox 508

For more information, e.g. the complete technical information, see product manual for:
Orion1 Extended [2TLC172290M0201](#)

Dimension drawings Orion1 Extended

Orion1 Extended

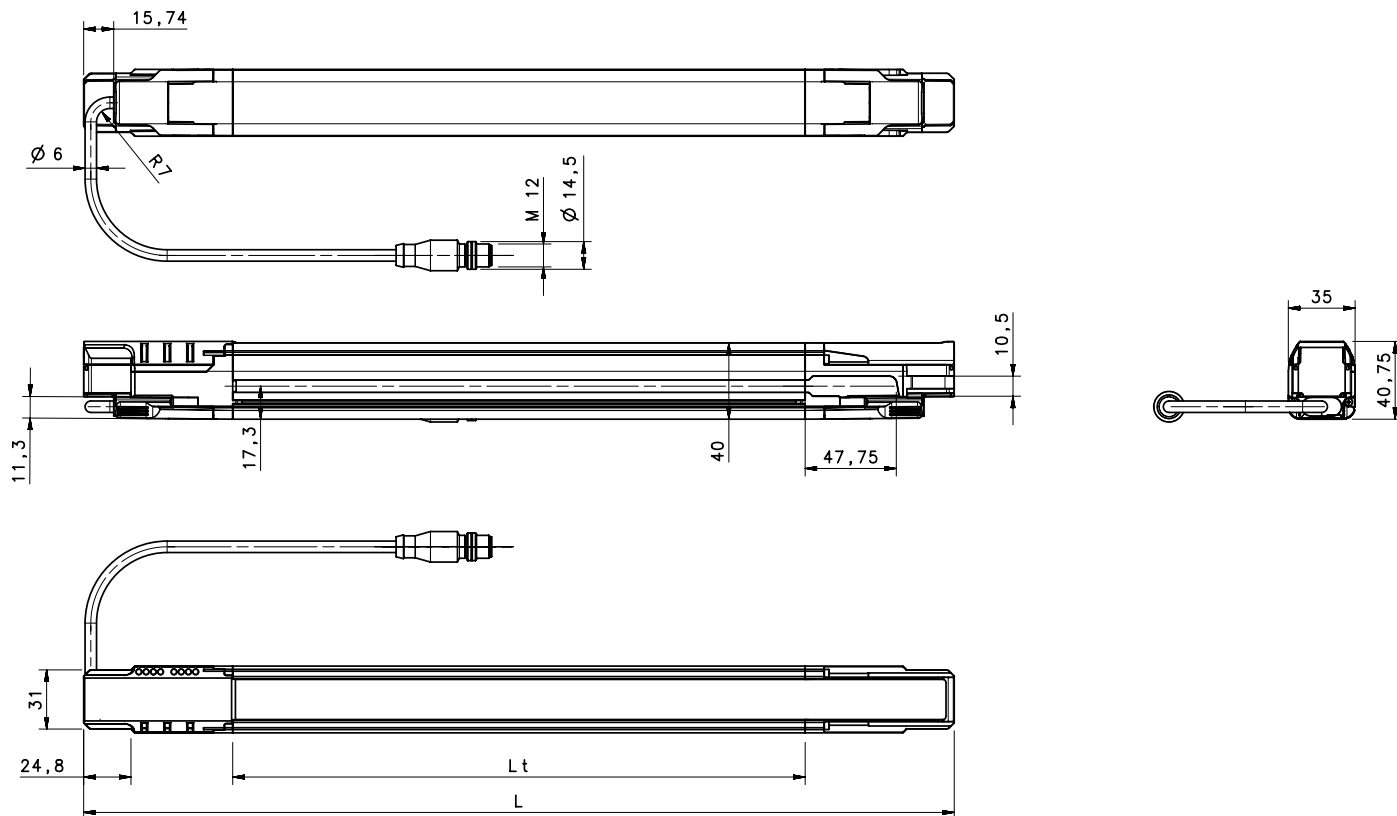

All dimensions in mm

Dimension

L1 mm	L2 mm	Type
300	306.3	Orion1-4-xx-030-E
450	456.3	Orion1-4-xx-045-E
600	606.3	Orion1-4-xx-060-E
750	756.3	Orion1-4-xx-075-E
900	906.3	Orion1-4-xx-090-E
1050	1056.3	Orion1-4-xx-105-E
1200	1206.3	Orion1-4-xx-120-E
1350	1356.3	Orion1-4-xx-135-E
1500	1506.3	Orion1-4-xx-150-E
1650	1656.3	Orion1-4-xx-165-E
1800	1806.3	Orion1-4-xx-180-E

xx = Resolution (14 or 30 mm)

Safety light grid Orion2 Base

Orion2 Base is a compact light grid for access protection.

The light grid has 2-4 beams and is intended for body detection.

3 With an operating distance of 50 m between transmitter and receiver the light grid is suitable for applications with deviating mirrors.



Cost effective solution

Minimized cabling

A local reset button can be connected directly to the light grid, eliminating the need for cable between the reset button and the electrical cabinet or for an extra control module.

External device monitoring

Each light grid can monitor the actuators without any extra control module (EDM function).



Easy to install

Alignment help

Alignment help and a wide angle within the limits of a Type 4 device facilitate installation.

Easy adjustment

Rotation brackets makes alignment easy.

Fast connection

M12 connectors speed up cabling.



Continuous operation

Protection in harsh environments

The housing is IP65 rated, and protective tubes and lens shields are available to provide further protection for the device in harsh environments.

Applications and features

Orion2 Base

Application

Body detection over long distances

With 2-4 beams and a maximum sensing range of 50 m between transmitter and receiver, the light grid is intended for body detection and can be used with deviating mirrors to form a protective perimeter around a dangerous area.

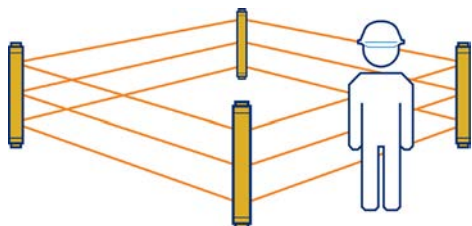

Features

EDM

External Device Monitoring is a feature allowing the light guard to supervise the actuators in simpler applications, eliminating the need for a safety relay or programmable safety controller.

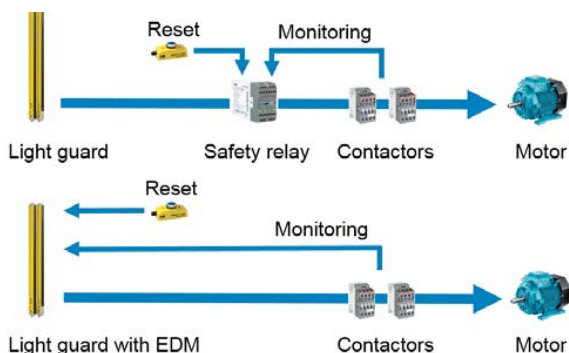

Local reset

A local reset button is connected directly to the light guard instead of to the safety control module in the electrical cabinet. This saves safety relays/programmable inputs and minimizes cabling to the electrical cabinet. Clever accessories make the connection easier.



Ordering information

Orion2 Base

3



Orion2 Base

Ordering details

Detection	Protected height mm	Type (Transmitter + receiver)	Order code
Body	500 (2 beams)	Orion2-4-K2-050-B	2TLA022304R0000
	800 (3 beams)	Orion2-4-K3-080-B	2TLA022304R0100
	900 (4 beams)	Orion2-4-K4-090-B	2TLA022304R0200
	1200 (4 beams)	Orion2-4-K4-120-B	2TLA022304R0300



JSM Orion01

Spare parts (included when ordering Orion)

Description	Type	Order code
4 standard brackets for Orion1 & Orion2	JSM Orion01	2TLA022310R0000

Accessories Orion2 Base



JSM Orion 04

2TLC172776F0201



M12-3R

2TLC172012W0201



Smile 11 RB

2TLC172369F0201



Tina 10 C

2TLC172477F0201

Accessories

Mounting accessories

Description	Type	Order code
Orion Test Piece 14 mm	Orion TP-14	2TLA022310R5200
Orion Test Piece 30 mm	Orion TP-30	2TLA022310R5300
Orion Laser pointer	Orion Laser	2TLA022310R5000
Screw MC6S M5x12 to be used with T-nut JSM M5B for mounting Orion on Quick-Guard	Screw MC6S	2TLJ041012R0200
JSM M5B Special T-nut M5 to be used with screw MC6S for mounting Orion on Quick-Guard	T-nut JSM M5B	2TLA040035R0400
4 rotation brackets for Orion2	JSM Orion04	2TLA022310R0200
Kit for mounting of Orion1 & Orion2 in Stand (4 pieces for lengths shorter than 1200 mm)	JSM Orion06	2TLA022310R0400
Kit for mounting of Orion1 & Orion2 in Stand (6 pieces for lengths of 1200 mm or more)	JSM Orion07	2TLA022310R0500
Orion Plate kit for adjustment of protective stand	Orion Stand Plate	2TLA022312R5000
Deviating mirror in stand for Orion 2 and 3	Orion Mirror*	
Protective stand	Orion Stand*	
Protective tube	Orion WET*	
Lens shield	Orion Shield*	

Connection accessories

Smile reset button with NO contact	Smile 11 RA	2TLA030053R0000
Smile reset button with NO contact for Pluto	Smile 11 RB	2TLA030053R0100
Smile reset button with NO contact for Orion1 Base	Smile 11R01	2TLA022316R3000
Y-connector for series connection of DYNlink devices with M12-5 connectors, e.g. Eden	M12-3A	2TLA020055R0000
Y-connector for connection of a Smile reset button to Orion	M12-3R	2TLA022316R0000
Y-connector for easy connection of a transmitter	M12-3D	2TLA020055R0300
Adaptation of OSSD to DYNlink. Two M12-5 connectors.	Tina 10A	2TLA020054R1200
Adaptation of OSSD to DYNlink with possibility to connect a local reset button. Three M12-5 connectors.	Tina 10B	2TLA020054R1300
Adaptation of OSSD to DYNlink with possibility to power the transmitter. Three M12-5 connectors.	Tina 10C	2TLA020054R1600
Safe AS-i input slave for OSSD, 3 non safe inputs and 1 reset input	Urax-D1R	2TLA020072R0500

*These accessories are available in different sizes.

For more information see:

Orion Mirror [2TLC172060L0201](#), Orion Stand [2TLC172059L0201](#), Orion WET [2TLC172061L0201](#), Orion Shield [2TLC172071L0201](#)

For more information about the connection accessories, please see:

Orion connection accessories [2TLC172101L0201](#)

How to choose correct reset button

Local or global reset	Adaption to DYNlink	Safety control module	Type	Useful connection accessories
Local reset button connected to the light guard (Orion in manual reset mode)	Yes	Vital or Pluto	Smile 11R02	Tina 10B: OSSD to DYNlink + local reset button M12-3A: Serial connection of the DYNlink
	No	Any safety control module compatible with light guard	Smile 11R02	M12-3R: Easy connection of a local reset button
Global reset button connected to the control module (Orion in automatic reset mode)	Yes	Vital	Smile 11 RA	Tina 10A: OSSD to DYNlink Tina 10C: OSSD to DYNlink + supply to transmitter
		Pluto	Smile 11 RB	Tina 10A: OSSD to DYNlink Tina 10C: OSSD to DYNlink + supply to transmitter
	No	Any safety control module compatible with light guard	Smile 11 RA**	-

* The ABB Jokab Safety DYNlink solution offers the following advantages:

- Serial connection of safety devices while maintaining PLe/cat. 4, up to 25 Tina 10 per Vital and up to 5 Tina 10 per Pluto input.
- Only one safety input of the Pluto instead of two with the standard OSSD outputs.

** Smile 11RA has one NO contact, which is the most common for reset buttons. Please check what is requested for the chosen safety control module.

Cables Orion2 Base

3



M12-C61

2TLC172957FC0201



M12-C61HE

2TLC010003FC0201



M12-C334

2TLC172931FC0201

Cable with connectors

Connector	Female/male	Length	Special feature	Type	Order code
M12-5	Female	6 m		M12-C61	2TLA020056R0000
			Harsh environment, halogen free	M12-C61HE	2TLA020056R8000
		10 m		M12-C101	2TLA020056R1000
			Harsh environment, halogen free	M12-C101HE	2TLA020056R8100
	Female + male	20 m		M12-C201	2TLA020056R1400
		0.3 m		M12-C0312	2TLA020056R5800
		0.06 m		M12-C00612	2TLA020056R6300
		1 m		M12-C112	2TLA020056R2000
		3 m		M12-C312	2TLA020056R2100
		6 m		M12-C612	2TLA020056R2200
M12-8	Female	10 m		M12-C1012	2TLA020056R2300
		16 m		M12-C1612	2TLA020056R5400
		20 m		M12-C2012	2TLA020056R2400
		6 m		M12-C63	2TLA020056R3000
	Female + male	10 m		M12-C103	2TLA020056R4000
		20 m		M12-C203	2TLA020056R4100
		0.06 m		M12-C00634 ¹	2TLA020056R6400
		1 m		M12-C134 ¹	2TLA020056R5000
		3 m		M12-C334 ¹	2TLA020056R5100
		M12-8 female + M12-5 male	Female + male	1	

1) Used for the connection to Tina 10, M12-3D and M12-3R. Tina 10 can be connected directly to the light guard without cable, but will form an angle (i.e. not be aligned) with the light guard, which might be a problem if the light guard is mounted close to a wall/ aluminum profile.

2) M12-CT132 is used for the connection of Orion2 Base to URAX-D1R.

Separate cables and connectors

Description	Type	Order code
Connectors		
M12-5 pole female, straight	M12-C01	2TLA020055R1000
M12-5 pole male, straight	M12-C02	2TLA020055R1100
M12-8 pole female, straight	M12-C03	2TLA020055R1600
M12-8 pole male, straight	M12-C04	2TLA020055R1700



M12-C01

2TLC172865FC0201



C5 cable

2TLC010038FC0201

Cable with 5 conductors

10 m cable with 5 x 0.34 shielded conductors	C5 cable 10 m	2TLA020057R0001
50 m cable with 5 x 0.34 shielded conductors	C5 cable 50 m	2TLA020057R0005
100 m cable with 5 x 0.34 shielded conductors	C5 cable 100 m	2TLA020057R0010
200 m cable with 5 x 0.34 shielded conductors	C5 cable 200 m	2TLA020057R0020
500 m cable with 5 x 0.34 shielded conductors	C5 cable 500 m	2TLA020057R0050



Cable with 8 conductors

50 m cable with 8 x 0.34 shielded conductors	C8 cable 50 m	2TLA020057R1005
100 m cable with 8 x 0.34 shielded conductors	C8 cable 100 m	2TLA020057R1010
200 m cable with 8 x 0.34 shielded conductors	C8 cable 200 m	2TLA020057R1020
500 m cable with 8 x 0.34 shielded conductors	C8 cable 500 m	2TLA020057R1050

Technical data

Orion2 Base

Technical data

Approvals	 
Conformity	CE 2006/42/EC - Machinery 2004/108/EC - EMC EN ISO 13849-1:2008, EN 62061:2005/A1:2013, EN 61496-1:2013, EN 61496-2, EN 61508-1:2010, EN 61508-2:2010, EN 61508-3:2010, EN 61508-4:2010
Functional safety data	
EN 61508:2010	SIL3, PFH _D = 2.64 x 10 ⁻⁹
EN 62061:2005+A1:2013	SILCL3, PFH _D = 2.64 x 10 ⁻⁹
EN ISO 13849-1:2008	PL e, Cat. 4, PFH _D = 2.64 x 10 ⁻⁹
Electrical data	
Power supply	+24 VDC ± 20% (SELV/PELV)
Power consumption, Transmitter	30 mA max. / 0.9 W
Power consumption, Receiver	75 mA max. (without load) / 2.2 W
Cable length (for power supply)	50 m max with 50 nF capacitive load and +24 VDC
Internal capacitance	23 nF (Transmitter) / 120 nF (Receiver)
Outputs	2 PNP
Short-circuit protection	Max 1.4 A at 55 °C, min. 1.1 A at -10 °C
Output current	0.5 A max / output
Leakage current	< 1 mA
Capacitive load (pure)	65 nF max at 25 °C
Resistive load (pure)	56 Ω min at +24 VDC
Current for external lamp	20 mA min, 250 mA max
Connectors	M12-4 pole male on transmitter (compatible with M12-5 pole female) M12-8 pole male on receiver
Optical data	
Light emission (λ)	Infrared, LED (880 nm)
Resolution	315 - 515 mm
Operating distance	0.5...50 m
Ambient light rejection	According to IEC-61496-2:2013
Mechanical data	
Operating temperature	10...+ 55 °C
Storage temperature	- 25...+ 70 °C
Humidity range	15...95% (no condensation)
Protection class	IP65 (EN 60529:2000)
Weight	1.2 kg max / meter for each single unit
Housing material	Painted aluminium (yellow RAL 1003)
Front glass material	PMMA
Cap material	PC Lexan 943A

Dimension drawings Orion2 Base

Orion2 Base

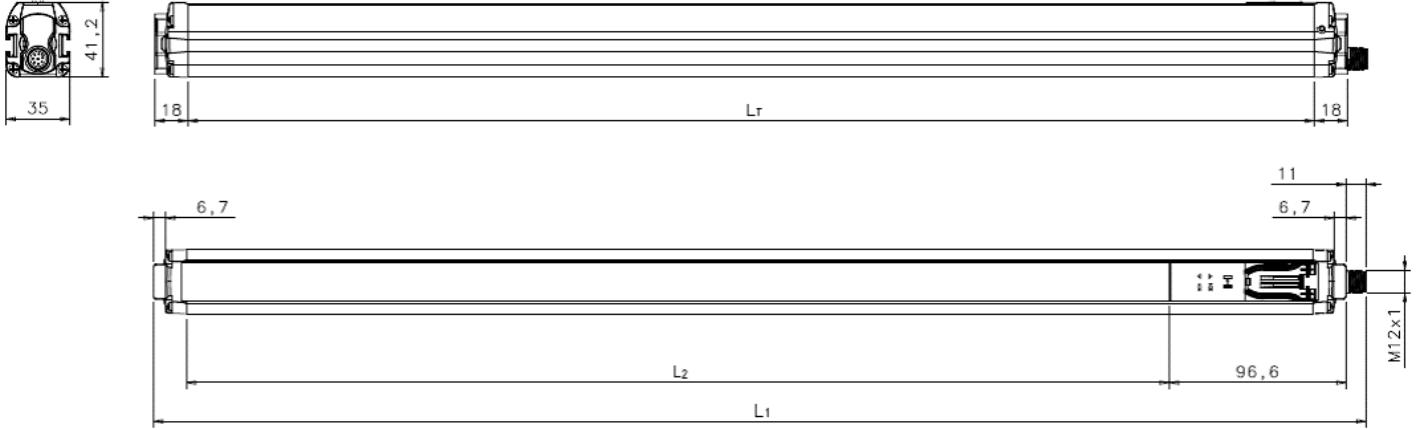

All dimensions in mm

Dimension

L_r mm	L_1 mm	L_2 mm	Type
617	664	538.4	Orion2-4-K2-050-B
917	964	838.4	Orion2-4-K3-080-B
1017	1064	938.4	Orion2-4-K4-090-B
1317	1364	1238.4	Orion2-4-K4-120-B

xx = Resolution

Safety light grid Orion2 Extended

Orion2 Extended is a compact light grid for access protection in muting applications.

The light grid has 2-4 beams and is intended for body detection.

3



Cost effective solution

Integrated muting function

Muting sensors are connected directly to the light grid, with no need for a remote muting module.

Minimized cabling

A local reset button can be connected directly to the light grid, eliminating the need for cable between the reset button and the electrical cabinet.

External device monitoring (EDM)

Each light grid can monitor the actuators without any extra control module.



Easy to install

Alignment help

Alignment help and a wide angle within the limits of a Type 4 device facilitate installation.

Easy adjustment

Rotation brackets makes alignment easy.

Fast connection

M12 connectors speed up cabling.



Continuous operation

Protection in harsh environments

The housing is IP65 rated, and protective tubes and lens shields are available to provide further protection for the device in harsh environments.

Features

Orion2 Extended

Muting

Orion2 Extended is intended for muting applications. By connecting muting sensors to the light guard, it can distinguish material from persons and allow the material to pass through an opening but not persons. Muting sensors and a connection box for muting are available to simplify the muting application.

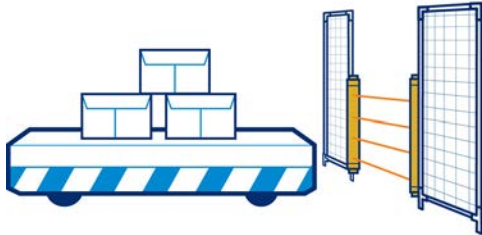

Local reset

A local reset button is connected directly to the light guard instead of to the safety control module in the electrical cabinet. This saves safety relays/PLC inputs and minimizes cabling to the electrical cabinet. Clever accessories makes the connection easier.



EDM

External Device Monitoring is a feature allowing the light guard to supervise the actuators in simpler applications, eliminating the need for a safety relay or programmable safety controller.

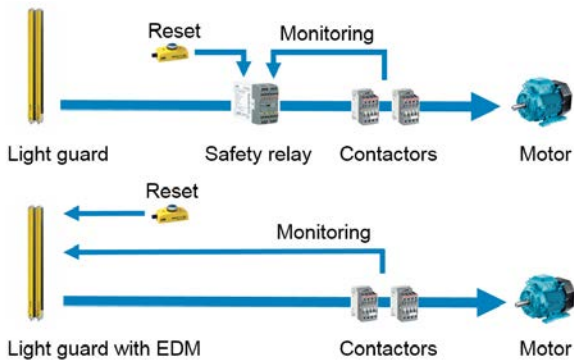

Ordering information

Orion2 Extended

3



2TLC172798R0201

Orion2 Extended

Ordering details

Resolution (Detection) mm	Protected height mm	Type (Transmitter + receiver)	Order code
Body	500 (2 beams)	Orion2-4-K2-050-E	2TLA022305R0000
	800 (3 beams)	Orion2-4-K3-080-E	2TLA022305R0100
	900 (4 beams)	Orion2-4-K4-090-E	2TLA022305R0200
	1200 (4 beams)	Orion2-4-K4-120-E	2TLA022305R0300



2TLC172781F0201

JSM Orion01

Spare parts (included when ordering Orion)

Description	Type	Order code
4 standard brackets for Orion1 & Orion2	JSM Orion01	2TLA022310R0000

Accessories

Orion2 Extended



OMC1

2TLC172016V0201



Mute R2

2TLC172091V0201

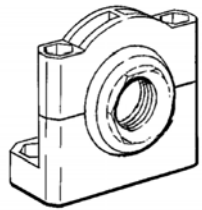

JSM 64

2TLC10032F0201



Reflect 2

2TLC172089V0201



Smile 11 RB

2TLC172367F0201



Orion Laser pointer

2TLC172816F0201

Connection accessories

Connection accessories

Description	Type	Order code
Connection box for two or four muting sensors	OMC1	2TLA022316R2000
Retroreflex photoelectric sensor	Mute R2	2TLA022044R0500
Adjustable mounting bracket for M18 sensors (e.g. Mute R2 and Spot 10).	JSM 64	2TLA040007R0200
Reflector diameter 63 mm	Reflect 1	2TLA022044R2000
Reflector diameter 82 mm	Reflect 2	2TLA022044R3000
Smile reset button with NO contact	Smile 11 RA	2TLA030053R0000
Smile reset button with NO contact for Pluto	Smile 11 RB	2TLA030053R0100
Smile reset button with NC contact for Orion2 Base/Extended and Orion3 Extended	Smile 11 RO2	2TLA022316R3100
Y-connector for series connection of DYNlink devices with M12-5 connectors, e.g. Eden	M12-RA	2TLA020055R0000
Y-connector for connection of a Smile reset button to Orion	M12-3R	2TLA022316R0000
Y-connector for easy connection of a transmitter	M12-3D	2TLA020055R0300
Adaptation of OSSD to DYNlink. Two M12-5 connectors.	Tina 10A	2TLA020054R1200
Adaptation of OSSD to DYNlink with possibility to connect a local reset button. Three M12-5 connectors.	Tina 10B	2TLA020054R1300
Adaptation of OSSD to DYNlink with possibility to power the transmitter. Three M12-5 connectors.	Tina 10C	2TLA020054R1600
Safe AS-i input slave for OSSD, 3 non safe inputs and one reset input	Urax-D1R	2TLA020072R0500

Mounting accessories

Orion Test Piece 14 mm	Orion TP-14	2TLA022310R5200
Orion Test Piece 30 mm	Orion TP-30	2TLA022310R5300
Orion Laser pointer	Orion Laser	2TLA022310R5000
Screw MC6S M5x12 to be used with T-nut JSM M5B for mounting Orion on Quick-Guard	Screw MC6S	2TLJ041012R0200
JSM M5B Special T-nut M5 to be used with screw MC6S for mounting Orion on Quick-Guard	T-nut JSM M5B	2TLA040035R0400
4 standard brackets for Orion1 & Orion2	JSM Orion01	2TLA022310R0000
4 rotation brackets for Orion2	JSM Orion04	2TLA022310R0200
Kit for mounting of Orion1 & Orion2 in Stand (4 pieces for lengths shorter than 1200 mm)	JSM Orion06	2TLA022310R0400
Kit for mounting of Orion1 & Orion2 in Stand (6 pieces for lengths of 1200 mm or more)	JSM Orion07	2TLA022310R0500
Orion Plate kit for adjustment of protective stand	Orion Stand Plate	2TLA022312R5000
Deviating mirror in stand for Orion 2 and 3	Orion Mirror*	
Protective stand	Orion Stand*	
Protective tube	Orion WET*	
Lens shield	Orion Shield*	

*These accessories are available in different sizes. For more information see:

Orion Mirror [2TLC172060L0201](#), Orion Stand [2TLC172059L0201](#), Orion WET [2TLC172061L0201](#), Orion Shield [2TLC172071L0201](#)

For more information about the connection accessories, please see:

Orion connection accessories [2TLC172101L0201](#)

How to choose correct reset button

Local or global reset	Adaption to DYNlink	Safety control module	Type	Useful connection accessories
Local reset button connected to the light guard	Yes	Vital or Pluto	Smile 11RO2	Tina 10B: OSSD to DYNlink + local reset button M12-3A: Serial connection of DYNlink
(Orion in manual reset mode)	No	Any safety control module compatible with light guard	Smile 11RO2	M12-3R: Easy connection of a local reset button
Global reset button connected to the control module	Yes	Vital	Smile 11 RA	Tina 10A: OSSD to DYNlink Tina 10C: OSSD to DYNlink + supply to transmitter
(Orion in automatic reset mode)		Pluto	Smile 11 RB	Tina 10A: OSSD to DYNlink Tina 10C: OSSD to DYNlink + supply to transmitter
	No	Any safety control module compatible with light guard	Smile 11 RA**	-

* The ABB Jokab Safety DYNlink solution offers the following advantages:

- Serial connection of safety devices while maintaining PLe/cat. 4, up to 25 Tina 10 per Vital and up to 5 Tina 10 per Pluto input.
- Only one safety input of the Pluto instead of two with the standard OSSD outputs.

** Smile 11 RA has one NO contact, which is the most common for reset buttons. Please check what is requested for the chosen safety control module.

Cables

Orion2 Extended

3



M12-C61

2TLC172951F0201



M12-C61HE

2TLC010038F0201



M12-C334

2TLC172931F0201

Cable with connectors

Connector	Female/male	Length	Special feature	Type	Order code	
M12-5	Female	6 m		M12-C61	2TLA020056R0000	
			Harsh environment, halogen free	M12-C61HE	2TLA020056R8000	
		10 m		M12-C101	2TLA020056R1000	
			Harsh environment, halogen free	M12-C101HE	2TLA020056R8100	
	Female + male	20 m		M12-C201	2TLA020056R1400	
			0.3 m	M12-C0312	2TLA020056R5800	
			0.06 m	M12-C00612	2TLA020056R6300	
			1 m	M12-C112	2TLA020056R2000	
			3 m	M12-C312	2TLA020056R2100	
			6 m	M12-C612	2TLA020056R2200	
M12-8	Female	6 m		M12-C63	2TLA020056R3000	
			10 m	M12-C103	2TLA020056R4000	
		20 m		M12-C203	2TLA020056R4100	
			Female + male	20 m	0.06 m	M12-C00634 ¹
	1 m	M12-C134 ¹	2TLA020056R5000			
	3 m	M12-C334 ¹	2TLA020056R5100			
	M12-8 male + female	Female + male	0.2		M12-CT132 ²	2TLA020060R0600
	M12-8 female - M12-5 male	Female + male	1		M12-CYMUTE ³	2TLA022316R0100

1) Used for the connection to Tina 10, M12 3D and M12-3R. Tina 10 can be connected directly to the light guard without cable, but will form an angle (i.e. not be aligned) with the light guard, which might be a problem if the light guard is mounted close to a wall/ aluminum profile.

2) M12-CT132 is used for the connection of Orion2 Extended to URAX-D1R.

3) M12-CYMUTE is used to simplify the connection of 2 or 4 muting sensors with the help of the OMC1 connection box.

Separate cables and connectors

Description	Type	Order code
Connectors		
M12-5 pole female, straight	M12-C01	2TLA020055R1000
M12-5 pole male, straight	M12-C02	2TLA020055R1100
M12-8 pole female, straight	M12-C03	2TLA020055R1600
M12-8 pole male, straight	M12-C04	2TLA020055R1700

Cable with 5 conductors

10 m cable with 5 x 0.34 shielded conductors	C5 cable 10 m	2TLA020057R0001
50 m cable with 5 x 0.34 shielded conductors	C5 cable 50 m	2TLA020057R0005
100 m cable with 5 x 0.34 shielded conductors	C5 cable 100 m	2TLA020057R0010
200 m cable with 5 x 0.34 shielded conductors	C5 cable 200 m	2TLA020057R0020
500 m cable with 5 x 0.34 shielded conductors	C5 cable 500 m	2TLA020057R0050

Cable with 8 conductors

50 m cable with 8 x 0.34 shielded conductors	C8 cable 50 m	2TLA020057R1005
100 m cable with 8 x 0.34 shielded conductors	C8 cable 100 m	2TLA020057R1010
200 m cable with 8 x 0.34 shielded conductors	C8 cable 200 m	2TLA020057R1020
500 m cable with 8 x 0.34 shielded conductors	C8 cable 500 m	2TLA020057R1050



M12-C01

2TLC172657F0201



C5 cable

2TLC010038F0201

Connection examples

Orion2 Extended

Orion with Tina 10A/C

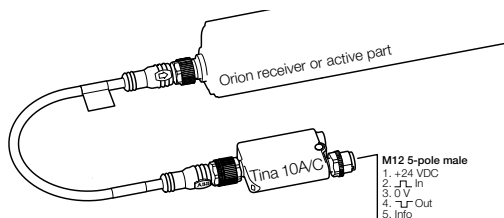

Without local reset button

Connection to the ABB Jokab Safety DYNlink signal via Tina 10 A/C. To be used with Vital safety control module or Pluto programmable safety controller.

Reset to Orion with Tina 10B

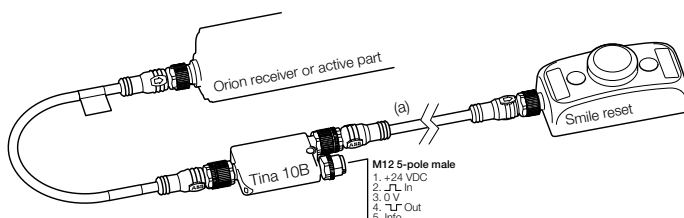

With local reset button

Connection to the ABB Jokab Safety DYNlink signal via Tina 10B. To be used with Vital safety control module or Pluto programmable safety controller.

Reset to Orion with M12-3R

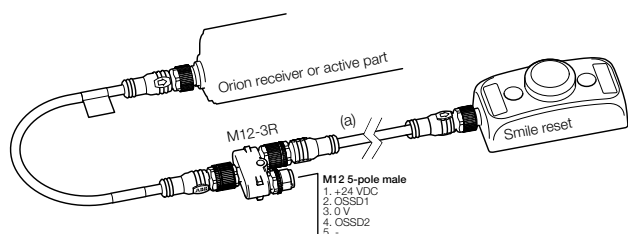

Connection of a local reset button via M12-3R.

Connection of muting sensors with M12-CYMUTE and OMC1

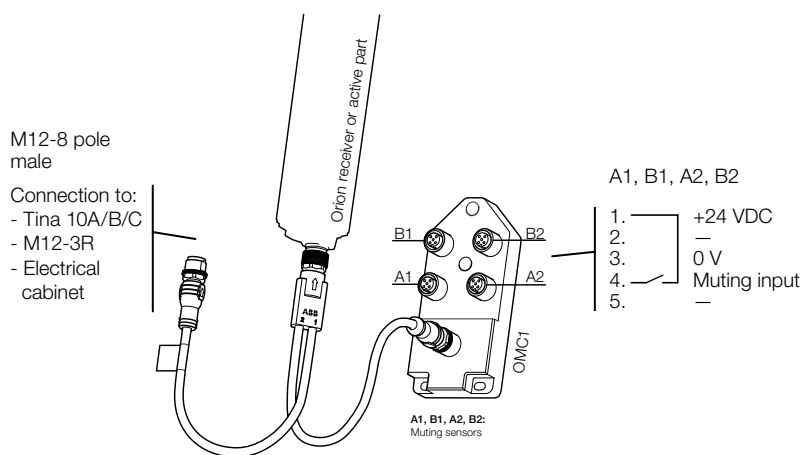



NB: Cable with M12-5 male + female connectors shall be used between muting sensors and OMC1 inputs A1, B1, A2, B2.

Technical data

Orion2 Extended

Technical data

Approvals	 
Conformity	CE 2006/42/EC - Machinery 2004/108/EC - EMC EN ISO 13849-1:2008, EN 62061:2005/A1:2013, EN 61496-1:2013, EN 61496-2, EN 61508-1:2010, EN 61508-2:2010, EN 61508-3:2010, EN 61508-4:2010
Functional safety data	
EN 61508:2010	SIL3, PFH _D = 2.64 x 10 ⁻⁹
EN 62061:2005+A1:2013	SILCL3, PFH _D = 2.64 x 10 ⁻⁹
EN ISO 13849-1:2008	PL e, Cat. 4, PFH _D = 2.64 x 10 ⁻⁹
Electrical data	
Internal capacitance	23 nF (Transmitter) / 120 nF (Receiver)
Power supply	+24 VDC ± 20% (SELV/PELV)
Power consumption, Transmitter	0.5 W during normal operation
Power consumption, Receiver	2 W during normal operation
Outputs	2 PNP
Short-circuit protection	Max 1.4 A at 55 °C, min 1.1 A at -10 °C
Output current	0.5 A max / output
Leakage current	< 1 mA
Capacitive load (pure)	65 nF max at 25 °C
Resistive load (pure)	56 Ω min at +24 VDC
Current for external lamp	20 mA min, 250 mA max
Response time	2 and 3 beams: 14 ms; 4 beams: 16 ms
Connectors	M12-4 pole male on transmitter (compatible with M12-5 pole female) M12-8 pole male on receiver
Optical data	
Light emission (λ)	Infrared (880 nm)
Resolution	315 - 515 mm
Operating distance	0.5...50 m
Ambient light rejection	According to IEC-61496-2:2013
Mechanical data	
Operating temperature	- 10...+ 55 °C
Storage temperature	- 25...+ 70 °C
Humidity range	15...95% (no condensation)
Protection class	IP65 (EN 60529:2000)
Weight	1.2 kg max / meter for each single unit
Housing material	PC Lexan 943A
Lens material	PMMA
Cap material	PC MAKROLON

For more information, e.g. the complete technical information, see manual for:
Orion2 Extended [2TLC172291M0201](#)

Dimension drawings Orion2 Extended

Orion2 Extended

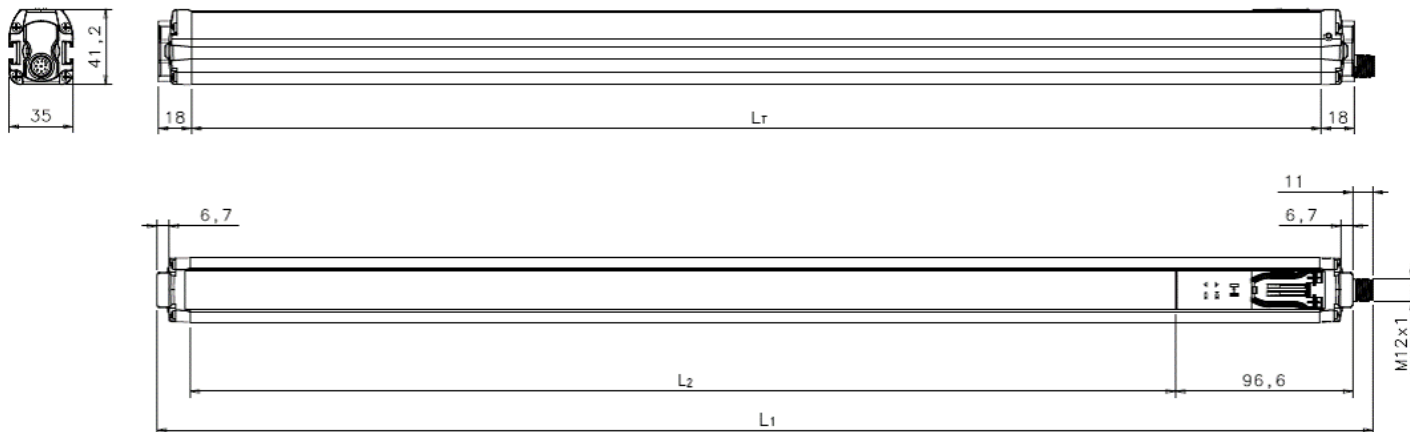

All dimensions in mm

Dimension

Lr mm	L1 mm	L2 mm	Type
617	664	538.4	Orion2-4-K2-050-E
917	964	838.4	Orion2-4-K3-080-E
1017	1064	938.4	Orion2-4-K4-090-E
1317	1364	1238.4	Orion2-4-K4-120-E

Safety light grid Orion3 Base

Orion3 Base is a light grid with a sturdy profile for access protection.

Only one of the parts needs power supply, since both transmitter and receiver are in the same active part. The other part is passive with mirrors to reflect the beams.

With 2-4 beams and an operating range of up to 8 m, it is intended for body detection.



3



Easy to install

Alignment help

Alignment help and a wide angle within the limits of a Type 4 device facilitate installation.

Easy adjustment

Rotation brackets makes alignment easy.

Fast connection

M12 connectors speed up cabling.

Less cabling

Only the active part needs connecting.



Cost effective solution

Minimized cabling

A local reset button can be connected directly to the light grid, eliminating the need for cable between the reset button and the electrical cabinet or for an extra control module.

External device monitoring

Each light grid can monitor the actuators without any extra control module (EDM function).



Continuous operation

Visible alignment level

Since the alignment level is displayed, the alignment can be improved before the occurrence of an unwanted stop.

Extensive error indication

Extensive error indication reduces troubleshooting time.

Features

Orion3 Base

Features

Sturdy profile for demanding applications

With its thicker and sturdier profile Orion3 is suitable for applications with tougher requirements.



Power on one side

Both transmitter and receiver is in one active part, and the other part is passive containing mirrors. This simplifies installation and saves cables, making it easier to place in applications where cables need to be avoided.

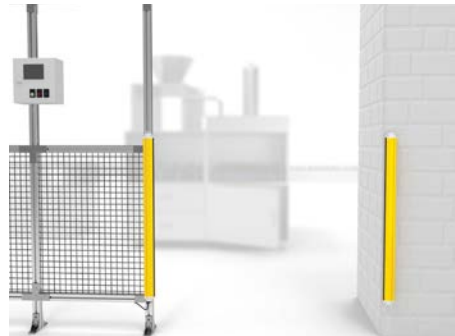

EDM

External Device Monitoring is a feature allowing the light guard to supervise the actuators in simpler applications, eliminating the need for a safety relay or programmable safety controller.

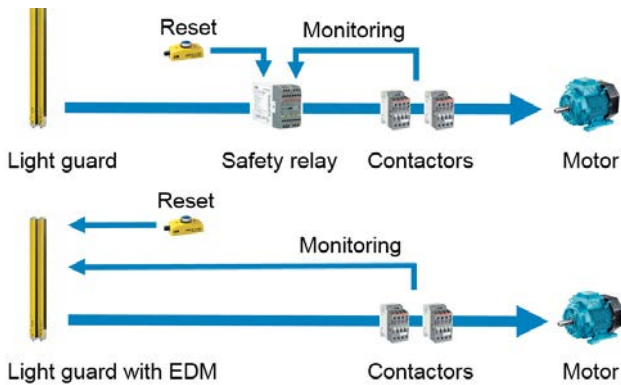

Local reset

A local reset button is connected directly to the light guard instead of to the safety control module in the electrical cabinet. This saves safety relays/PLC inputs and minimizes cabling to the electrical cabinet. Clever accessories make the connection easier.

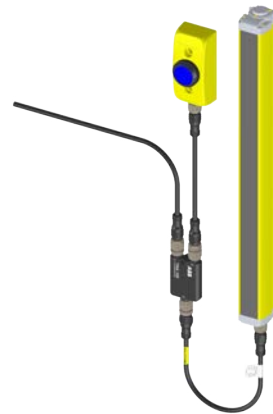

Ordering information

Orion3 Base

3



22TLC17286MFD01

Orion3 Base

Ordering details

Detection	Protected height mm	Active or passive part	Type	Order code
Body	500 (2 beams)	Active part	Orion3-4-K1C-050-B	2TLA022306R0000
		Passive part	Orion3-4-M1C-050	2TLA022306R1000
	800 (3 beams)	Active part	Orion3-4-K2C-080-B	2TLA022306R0100
		Passive part	Orion3-4-M2C-080	2TLA022306R1100
	900 (4 beams)	Active part	Orion3-4-K2C-090-B	2TLA022306R0200
		Passive part	Orion3-4-M2C-090	2TLA022306R1300
	1200 (4 beams)	Active part	Orion3-4-K2C-120-B	2TLA022306R0300
		Passive part	Orion3-4-M2C-120	2TLA022306R1400

Spare parts (included when ordering Orion)

Description	Type	Order code
4 standard brackets for Orion3	JSM Orion02	2TLA022310R1000



2TLA022310R1000

JSM Orion02

Accessories Orion3 Base



Orion Laser pointer

2TLC172816F0201



Smile 11 RB

2TLC172867F0201



M12-3R

2TLC17202V0201



Tina 10C

2TLC172477F0201

Accessories

Mounting accessories

Description	Type	Order code
Orion Laser pointer	Orion Laser	2TLA022310R5000
Screw MC6S M5x12 to be used with T-nut JSM M5B for mounting Orion on Quick-Guard	Screw MC6S	2TLJ041012R0200
JSM M5B Special T-nut M5 to be used with screw MC6S for mounting Orion on Quick-Guard	T-nut JSM M5B	2TLA040035R0400
4 standard brackets for Orion3	JSM Orion05	2TLA022310R0300
Kit for mounting of Orion3 in Stand (4 pieces for lengths shorter than 1200 mm)	JSM Orion08	2TLA022310R0600
Kit for mounting of Orion3 in Stand (6 pieces for lengths of 1200 mm or more)	JSM Orion09	2TLA022310R0700
Orion Plate kit for adjustment of protective stand	Orion Stand Plate	2TLA022312R5000
Deviating mirror in stand for Orion 2 and 3	Orion Mirror*	
Protective stand	Orion Stand*	

Connection accessories

Smile reset button with NO contact	Smile 11 RA	2TLA030053R0000
Smile reset button with NO contact for Pluto	Smile 11 RB	2TLA030053R0100
Smile reset button with NC contact for Orion3 Base	Smile 11 RC3	2TLA022316R3200
Y-connector for series connection of DYNlink devices with M12-5 connectors, e.g. Eden	M12-3A	2TLA020055R0000
Y-connector for connection of a Smile reset button to Orion	M12-3R	2TLA022316R0000
Y-connector for easy connection of a transmitter	M12-3D	2TLA020055R0300
Adaptation of OSSD to DYNlink. Two M12-5 connectors.	Tina 10A	2TLA020054R1200
Adaptation of OSSD to DYNlink with possibility to connect a local reset button. Three M12-5 connectors.	Tina 10B	2TLA020054R1300
Adaptation of OSSD to DYNlink with possibility to power the transmitter. Three M12-5 connectors.	Tina 10C	2TLA020054R1600
Safe AS-i input slave for OSSD, 3 non safe inputs and 1 reset input	Urax-D1R	2TLA020072R0500

*These accessories are available in different sizes.

For more information see:

Orion Mirror [2TLC172060L0201](#)

Orion Stand [2TLC172059L0201](#)

For more information about the connection accessories, please see:

Orion connection accessories [2TLC172101L0201](#)

How to choose correct reset button

Local or global reset	Adaption to DYNlink	Safety control module	Type	Useful connection accessories
Local reset button connected to the light guard (Orion in manual reset mode)	Yes	Vital or Pluto	Smile 11 RC3	Tina 10B: OSSD to DYNlink solution + local reset button M12-3A: Serial connection of the DYNlink solution
	No	Any safety control module compatible with light guard	Smile 11 RC3	M12-3R: Easy connection of a local reset button
Global reset button connected to the control module (Orion in automatic reset mode)	Yes	Vital	Smile 11 RA	Tina 10A: OSSD to DYNlink solution Tina 10C: OSSD to DYNlink solution + supply to transmitter/active part
		Pluto	Smile 11 RB	Tina 10A: OSSD to DYNlink solution Tina 10C: OSSD to DYNlink solution + supply to transmitter/active part
	No	Any safety control module compatible with light guard	Smile 11 RA**	-

* The ABB Jokab Safety DYNlink solution offers the following advantages:

- Serial connection of safety devices while maintaining PLe/cat. 4, up to 25 Tina 10 per Vital and up to 5 Tina 10 per Pluto input.
- Only one safety input of the Pluto instead of two with the standard OSSD outputs.

** Smile 11 RA has one NO contact, which is the most common for reset buttons. Please check what is requested for the chosen safety control module.

Cables Orion3 Base

3



M12-C61

2TLC172951F0201



M12-C61HE

2TLC010008R0201



M12-C334

2TLC172931F0201

Cable with connectors

Connector	Female/male	Length	Special feature	Type	Order code	
M12-5	Female	6 m		M12-C61	2TLA020056R0000	
			Harsh environment, halogen free	M12-C61HE	2TLA020056R8000	
		10 m		M12-C101	2TLA020056R1000	
			Harsh environment, halogen free	M12-C101HE	2TLA020056R8100	
		20 m		M12-C201	2TLA020056R1400	
	Female + male	0.3 m		M12-C0312	2TLA020056R5800	
		0.06 m		M12-C00612	2TLA020056R6300	
		1 m		M12-C112	2TLA020056R2000	
		3 m		M12-C312	2TLA020056R2100	
		6 m		M12-C612	2TLA020056R2200	
		10 m		M12-C1012	2TLA020056R2300	
M12-8	Female	6 m		M12-C63	2TLA020056R3000	
		10 m		M12-C103	2TLA020056R4000	
		20 m		M12-C203	2TLA020056R4100	
	Female + male	0.06 m		M12-C00634	2TLA020056R6400	
		1 m		M12-C134	2TLA020056R5000	
		3 m		M12-C334	2TLA020056R5100	
		0.2 m		M12-CTO3B ¹	2TLA022315R3200	
	M12-8 female + M12-5 male	Female + male	1 m		M12-CTURAX-03B ²	2TLA022315R3400

1) M12-CTO3B can be used for: - connection of Orion3 Base to Tina 10A/B/C.
- connection of Orion 3 Base to M12-3R.

The EDM function is deactivated in all cases

2) M12-CTURAX-03B is used for: - connection of Orion3 Base to URAX-D1R.

The light guard is automatically configured in automatic reset and the EDM function is deactivated.

Separate cables and connectors

Description	Type	Order code
Connectors		
M12-5 pole female, straight	M12-C01	2TLA020055R1000
M12-5 pole male, straight	M12-C02	2TLA020055R1100
M12-8 pole female, straight	M12-C03	2TLA020055R1600
M12-8 pole male, straight	M12-C04	2TLA020055R1700

Cable with 5 conductors

10 m cable with 5 x 0.34 shielded conductors	C5 cable 10 m	2TLA020057R0001
50 m cable with 5 x 0.34 shielded conductors	C5 cable 50 m	2TLA020057R0005
100 m cable with 5 x 0.34 shielded conductors	C5 cable 100 m	2TLA020057R0010
200 m cable with 5 x 0.34 shielded conductors	C5 cable 200 m	2TLA020057R0020
500 m cable with 5 x 0.34 shielded conductors	C5 cable 500 m	2TLA020057R0050

Cable with 8 conductors

50 m cable with 8 x 0.34 shielded conductors	C8 cable 50 m	2TLA020057R1005
100 m cable with 8 x 0.34 shielded conductors	C8 cable 100 m	2TLA020057R1010
200 m cable with 8 x 0.34 shielded conductors	C8 cable 200 m	2TLA020057R1020
500 m cable with 8 x 0.34 shielded conductors	C8 cable 500 m	2TLA020057R1050



M12-C01

2TLC172657F0201



C5 cable

2TLC010008R0201

Connection examples

Orion3 Base

Orion with Tina 10A/C

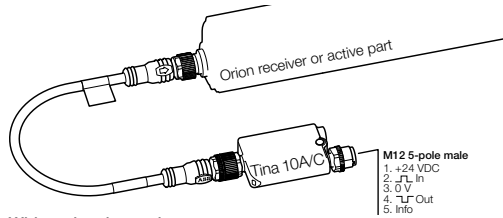

Without local reset button

Connection to the ABB Jokab Safety DYNlink signal via Tina 10 A/C. To be used with Vital safety control module or Pluto programmable safety controller.

Reset to Orion with Tina 10B

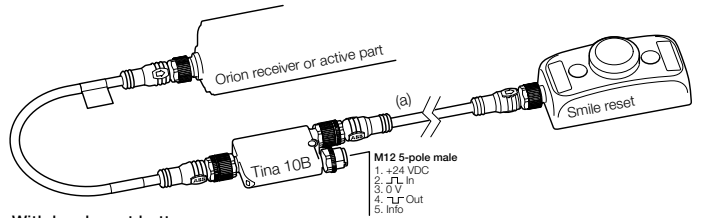

With local reset button

Connection to the ABB Jokab Safety DYNlink signal via Tina 10B. To be used with Vital safety control module or Pluto programmable safety controller.

Reset to Orion with M12-3R

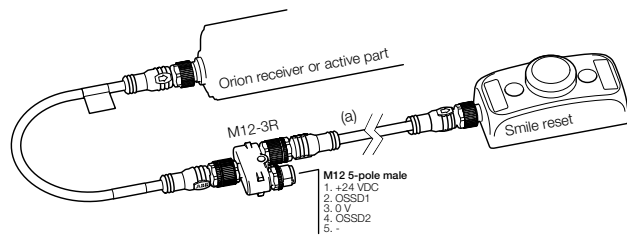

Connection of a local reset button via M12-3R.

Technical data

Orion3 Base

Technical data

Approvals	 
Conformity	CE 2006/42/EC - Machinery 2004/108/EC - EMC EN ISO 13849-1:2008, EN 62061:2005/A1:2013, EN 61496-1:2013, EN 61496-2, EN 61508-1:2010, EN 61508-2:2010, EN 61508-3:2010, EN 61508-4:2010
Functional safety data	
EN 61508:2010	SIL3, PFH _D = 9.28 x 10 ⁻⁹
EN 62061:2005+A1:2013	SILCL3, PFH _D = 9.28 x 10 ⁻⁹
EN ISO 13849-1:2008	PL e, Cat. 4, PFH _D = 9.28 x 10 ⁻⁹
Electrical data	
Power supply	+24 VDC ±20 %
Power consumption, Active unit	6.5 W max (without load)
Cable length (for power supply)	70 m max
Outputs	2 PNP
Short-circuit protection	1.4 A max
Output current	0.5 A max / output
Output voltage – ON	Power supply value less 1 V (min)
Output voltage – OFF	0.2 V max
Capacitive load	2.2 µF at +24 VDC max
Cable length (for power supply)	70 m max
Connectors	M12-8 pole male on receiver
Optical data	
Light emission (λ)	Infrared, LED (950 nm)
Resolution	319.75 - 519.75 mm
Operating distance	0.5...8 m except K2C-090: 0.5...6.5 m
Ambient light rejection	According to IEC-61496-2:2013
Mechanical data	
Operating temperature	0...+ 55 °C
Storage temperature	- 25...+ 70 °C
Humidity range	15...95% (no condensation)
Protection class	IP65 (EN 60529:2000)
Weight	
Orion3-4-K1C-050-B	1.3 kg
Orion3-4-K2C-080-B	1.8 kg
Orion3-4-K2C-090-B	2.1 kg
Orion3-4-K2C-120-B	2.6 kg
Orion3-4-M1C-050 (passive)	1.2 kg
Orion3-4-M2C-080 (passive)	1.7 kg
Orion3-4-M2C-090 (passive)	1.9 kg
Orion3-4-M2C-120 (passive)	2.5 kg
Housing material	Painted aluminium (yellow RAL 1003)
Cap material	PBT Valox 508
Lens material	PMMA

For more information about the connection accessories, see manual for:
 Orion3 Base [2TLC172289M0201](#)

Dimension drawings Orion3 Base

Orion3 Base

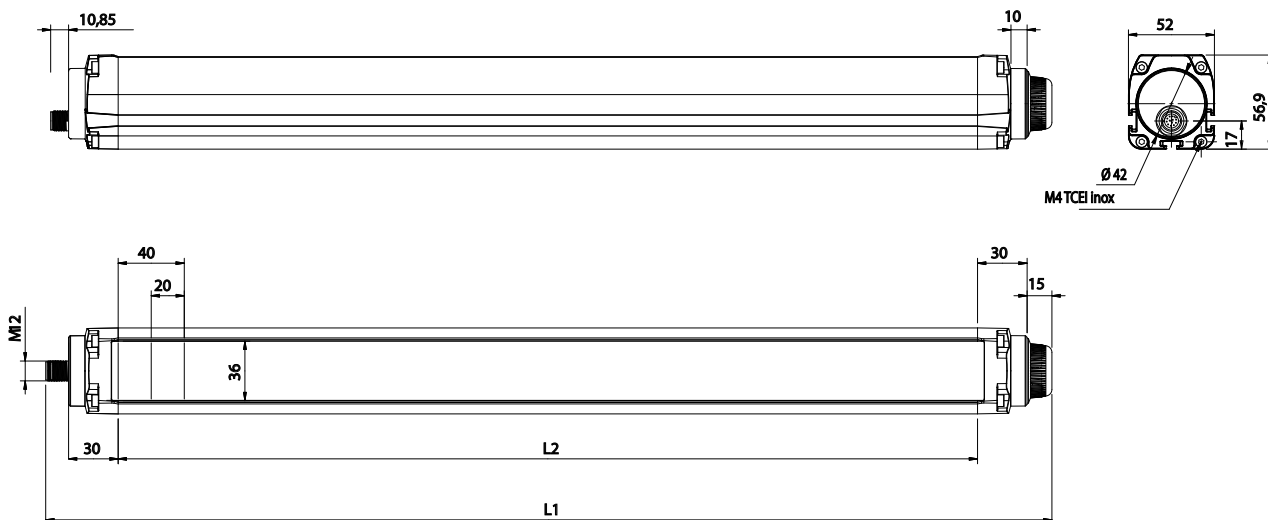

Active part – All dimensions in mm

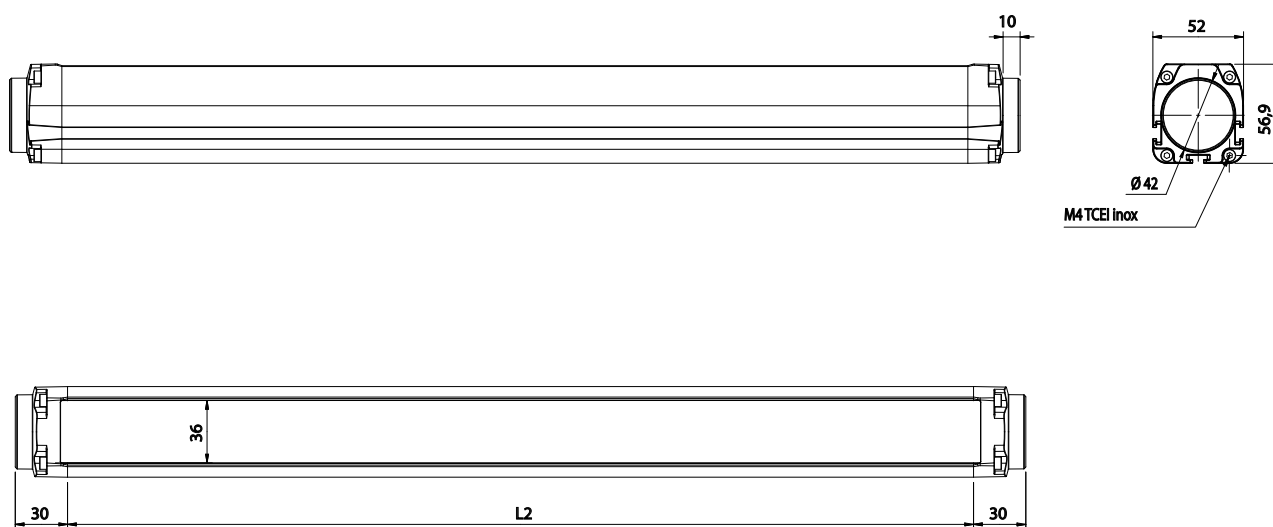

Passive part – All dimensions in mm

Dimensions

L1 mm	L2 mm	Type
606.4	520.5	Orion3-4-K1C-050-B (active part)
906.4	820.5	Orion3-4-K2C-080-B (active part)
1006.4	920.5	Orion3-4-K2C-090-B (active part)
1306.4	1220.5	Orion3-4-K2C-120-B (active part)
580.5	520.5	Orion3-4-M1C-050 (passive part)
880.5	820.5	Orion3-4-M2C-080 (passive part)
980.5	920.5	Orion3-4-M2C-090 (passive part)
1280.5	1220.5	Orion3-4-M2C-090 (passive part)

xx = Resolution

Safety light grid Orion3 Extended

Orion3 Extended is a sturdy light grid for access protection in muting applications.

Only one of the parts needs power supply, since both transmitter and receiver are in the same active part. The other part is passive and contains mirrors to reflect the beams.

With 2-4 beams and an operating range of up to 8 m, it is intended for body detection.



3



Cost effective solution

Integrated muting function

Muting sensors are connected directly to the light grid, with no need for a remote muting module.

Minimized cabling

A local reset button can be connected directly to the light grid, eliminating the need for cable between the reset button and the electrical cabinet.

External device monitoring (EDM)

Each light grid can monitor the actuators without any extra control module.



Easy to install

Alignment help

Alignment help and a wide angle within the limits of a Type 4 device facilitate installation.

Easy adjustment

Rotation brackets makes alignment easy.

Fast connection

M12 connectors speed up cabling.

Less cabling

Only the active part needs connecting.



Continuous operation

Visible alignment level

Since the alignment level is displayed, the alignment can be improved before the occurrence of an unwanted stop.

Extensive error indication

Extensive error indication reduces troubleshooting time.

Applications and features

Orion3 Extended

Application

Muting

Orion2 Extended is intended for muting applications. By connecting muting sensors to the light guard, it can distinguish material from persons and allow the material to pass through an opening but not persons. Muting sensors and a connection box for muting are available to simplify the muting application.

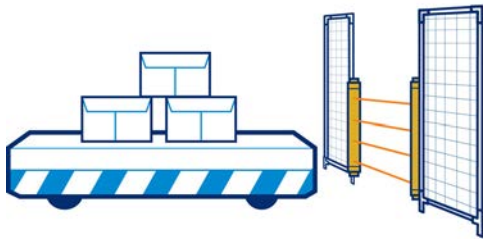

Features

Power on one side

Both transmitter and receiver are in one active part, and the other part is passive and contains mirrors. This simplifies installation and saves cables, making it easier to place in applications where cables need to be avoided.

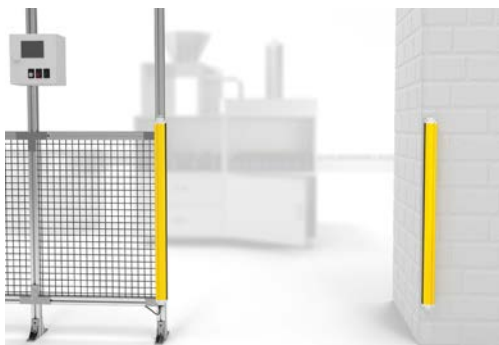

Sturdy profile for demanding applications

With its thicker and sturdier profile Orion3 is suitable for applications with tougher requirements.



EDM

External Device Monitoring is a feature allowing the light guard to supervise the actuators in simpler applications, eliminating the need for a safety relay or programmable safety controller.

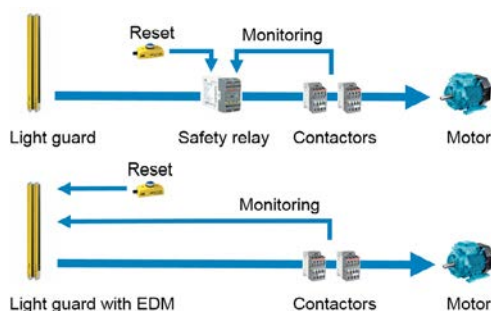

Local reset

A local reset button is connected directly to the light guard instead of to the safety control module in the electrical cabinet. This saves safety relays/PLC inputs and minimizes cabling to the electrical cabinet. Clever accessories make the connection easier.



Ordering information

Orion3 Extended

3



2TLC172804R0201

Orion3 Extended

Ordering details

Detection	Protected height mm	Active or passive part	Type	Order code
Body	500 (2 beams)	Active part	Orion3-4-K1C-050-E	2TLA022307R0000
		Passive part	Orion3-4-M1C-050	2TLA022306R1000
	800 (3 beams)	Active part	Orion3-4-K2C-080-E	2TLA022307R0100
		Passive part	Orion3-4-M2C-080	2TLA022306R1100
	900 (4 beams)	Active part	Orion3-4-K2C-090-E	2TLA022307R0200
		Passive part	Orion3-4-M2C-090	2TLA022306R1300
1200 (4 beams)	Active part	Orion3-4-K2C-120-E	2TLA022307R0300	
	Passive part	Orion3-4-M2C-120	2TLA022306R1400	

Please note that active and passive parts are ordered separately and both are necessary for Orion3 Extended to function.

Spare parts (included when ordering Orion)

Description	Type	Order code
4 standard brackets for Orion3	JSM Orion02	2TLA022310R1000



2TLC172779R0201

JSM Orion02

Accessories

Orion3 Extended



OMC1

2TLC172016R0201



Mute R2

2TLC172091V0201



Reflect 2

2TLC17208R0201

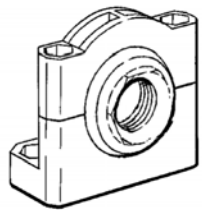

JSM 64

2TLC010032F02011



Smile 11 RB

2TLC172367F0201



Tina 10B

2TLC172475F0201



Orion Laser pointer

2TLC172816F0201

Accessories

Connection accessories

Description	Type	Order code
Connection box for two or four muting sensors	OMC1	2TLA022316R2000
Retroreflex photoelectric sensor	Mute R2	2TLA022044R0500
Adjustable mounting bracket for M18 sensors (e.g. Mute R2 and Spot 10).	JSM 64	2TLA040007R0200
Reflector diameter 63 mm	Reflect 1	2TLA022044R2000
Reflector diameter 82 mm	Reflect 2	2TLA022044R3000
Smile reset button with NO contact	Smile 11 RA	2TLA030053R0000
Smile reset button with NO contact for Pluto	Smile 11 RB	2TLA030053R0100
Smile reset button with NC contact for Orion2 Base/Extended and Orion3 Extended	Smile 11R02	2TLA022316R3100
Y-connector for series connection of DYNlink devices with M12-5 connectors, e.g. Eden	M12-3A	2TLA020055R0000
Y-connector for connection of a Smile reset button to Orion	M12-3R	2TLA022316R0000
Adaptation of OSSD to DYNlink. Two M12-5 connectors.	Tina 10A	2TLA020054R1200
Adaptation of OSSD to DYNlink with possibility to connect a local reset button. Three M12-5 connectors.	Tina 10B	2TLA020054R1300
Safe AS-i input slave for OSSD, 3 non safe inputs and one reset input	Urax-D1R	2TLA020072R0500

Mounting accessories

Orion Laser pointer	Orion Laser	2TLA022310R5000
Screw MC6S M5x12 to be used with T-nut JSM M5B for mounting Orion on Quick-Guard	Screw MC6S	2TLJ041012R0200
JSM M5B Special T-nut M5 to be used with screw MC6S for mounting Orion on Quick-Guard	T-nut JSM M5B	2TLA040035R0400
4 rotation brackets for Orion3	JSM Orion05	2TLA022310R0300
Kit for mounting of Orion3 in Stand (4 pieces) - For a pair Orion3 - 050 / 080 / 090 (active + passive units)	JSM Orion08	2TLA022310R0600
For a pair Orion3 - 120 (Orion3-4-K2C-120 + Orion3-4-M2C-120)	JSM Orion09	2TLA022310R0700
Orion Plate kit for adjustment of protective stand	Orion Stand Plate	2TLA022312R5000
Deviating mirror in stand for Orion 2 and 3	Orion Mirror*	
Protective stand	Orion Stand*	
Protective tube	Orion WET*	
Lens shield	Orion Shield*	

*These accessories are available in different sizes.

For more information see:

Orion Mirror [2TLC172060L0201](#), Orion Stand [2TLC172059L0201](#), Orion WET [2TLC172061L0201](#), Orion Shield [2TLC172071L0201](#)

For more information about the connection accessories, please see:

Orion connection accessories [2TLC172101L0201](#)

How to choose correct reset button

Local or global reset	Adaption to the DYNlink solution*	Safety control module	Type	Suitable connection accessories
Local reset button connected to the light guard	Yes	Vital or Pluto	Smile 11R02	Tina 10B: OSSD to DYNlink + local reset button M12-3A: serial connection of DYNlink
(Orion in manual reset mode)	No	Any safety control module compatible with light guard	Smile 11R02	M12-3R: Easy connection of a local reset button
Global reset button connected to the control module	Yes	Vital	Smile 11 RA	Tina 10A: OSSD to DYNlink Tina 10C: OSSD to DYNlink + supply to transmitter
(Orion in automatic reset mode)		Pluto	Smile 11 RB	Tina 10A: OSSD to DYNlink Tina 10C: OSSD to DYNlink + supply to transmitter
	No	Any safety control module compatible with light guard	Smile 11 RA**	-

* The ABB Jokab safety DYNlink solution offers the following advantages:

- Serial connection of safety devices while maintaining PLe/cat. 4, up to 25 Tina 10 per Vital and up to 5 Tina 10 per Pluto input.
- Only one safety input of the Pluto instead of two with the standard OSSD outputs.

** Smile 11RA has one NO contact, which is the most common for reset buttons. Please check what is requested for the chosen safety control module.

Cables Orion3 Extended

3



M12-C61

2TLC172951F0201



M12-C61HE

2TLC010038F0201



M12-C334

2TLC172931F0201

Cable with connectors

Connector	Female/male	Length	Special feature	Type	Order code		
M12-5	Female	6 m		M12-C61	2TLA020056R0000		
			Harsh environment, halogen free	M12-C61HE	2TLA020056R8000		
		10 m		M12-C101	2TLA020056R1000		
			Harsh environment, halogen free	M12-C101HE	2TLA020056R8100		
	Female + male	0.3 m		M12-C0312	2TLA020056R5800		
				M12-C00612	2TLA020056R6300		
				M12-C112	2TLA020056R2000		
				M12-C312	2TLA020056R2100		
				M12-C612	2TLA020056R2200		
				M12-C1012	2TLA020056R2300		
M12-8	Female	6 m		M12-C63	2TLA020056R3000		
				M12-C103	2TLA020056R4000		
		10 m		M12-C203	2TLA020056R4100		
				M12-C00634 ¹	2TLA020056R6400		
	Female + male	0.06 m		M12-C134 ¹	2TLA020056R5000		
				M12-C334 ¹	2TLA020056R5100		
				M12-CT132 ²	2TLA020060R0600		
				M12-CYMUTE ³	2TLA022316R0100		
			M12-8 female + M12-5 male	Female + male	1		

1) Used for the connection to Tina 10, M12 3D and M12-3R. Tina 10 can be connected directly to the light guard without cable, but will form an angle (i.e. not be aligned) with the light guard, which might be a problem if the light guard is mounted close to a wall/ aluminum profile.

2) M12-CT132 is used for the connection of Orion3 Extended to URAX-D1R.

3) M12-CYMUTE is used to simplify the connection of 2 or 4 muting sensors with the help of the OMC1 connection box.

Separate cables and connectors

Description	Type	Order code
Connectors		
M12-5 pole female, straight	M12-C01	2TLA020055R1000
M12-5 pole male, straight	M12-C02	2TLA020055R1100
M12-8 pole female, straight	M12-C03	2TLA020055R1600
M12-8 pole male, straight	M12-C04	2TLA020055R1700

Cable with 5 conductors

10 m cable with 5 x 0.34 shielded conductors	C5 cable 10 m	2TLA020057R0001
50 m cable with 5 x 0.34 shielded conductors	C5 cable 50 m	2TLA020057R0005
100 m cable with 5 x 0.34 shielded conductors	C5 cable 100 m	2TLA020057R0010
200 m cable with 5 x 0.34 shielded conductors	C5 cable 200 m	2TLA020057R0020
500 m cable with 5 x 0.34 shielded conductors	C5 cable 500 m	2TLA020057R0050

Cable with 8 conductors

50 m cable with 8 x 0.34 shielded conductors	C8 cable 50 m	2TLA020057R1005
100 m cable with 8 x 0.34 shielded conductors	C8 cable 100 m	2TLA020057R1010
200 m cable with 8 x 0.34 shielded conductors	C8 cable 200 m	2TLA020057R1020
500 m cable with 8 x 0.34 shielded conductors	C8 cable 500 m	2TLA020057R1050



M12-C01

2TLC172657F0201



C5 cable

2TLC010038F0201

Connection examples

Orion3 Extended

Orion with Tina 10A/C

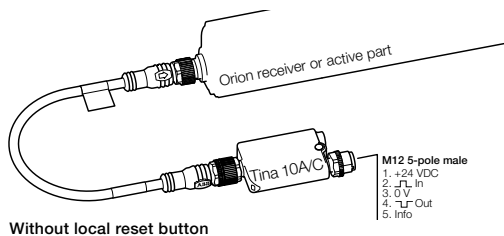

Without local reset button

Connection to the ABB Jokab Safety DYNlink signal via Tina 10 A/C. To be used with Vital safety control module or Pluto programmable safety controller.

Reset to Orion with Tina 10B

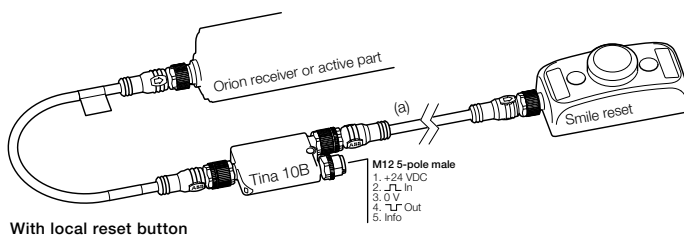

With local reset button

Connection to the ABB Jokab Safety DYNlink signal via Tina 10B. To be used with Vital safety control module or Pluto programmable safety controller.

Reset to Orion with M12-3R

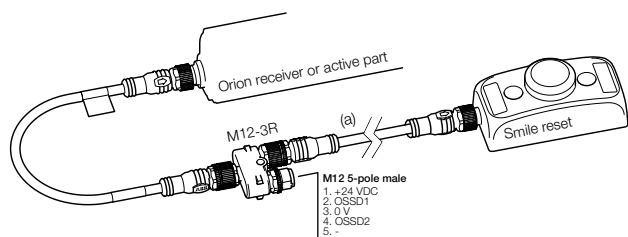

Connection of a local reset button via M12-3R.

Connection of muting sensors with M12-CYMUTE and OMC1

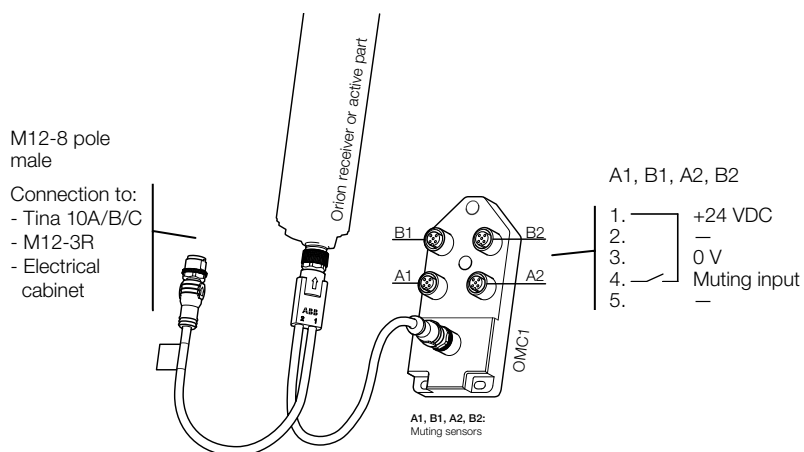



NB: Cable with M12-5 male + female connectors shall be used between muting sensors and OMC1 inputs A1, B1, A2, B2.

Technical data

Orion3 Extended

Technical data

Approvals	 
Conformity	CE 2006/42/EC - Machinery 2004/108/EC - EMC EN ISO 13849-1:2008, EN 62061:2005/A1:2013, EN 61496-1:2013, EN 61496-2, EN 61508-1:2010, EN 61508-2:2010, EN 61508-3:2010, EN 61508-4:2010
Functional safety data	
EN 61508:2010	SIL3, PFH _D = 8.57 x 10 ⁻⁹
EN 62061:2005+A1:2013	SILCL3, PFH _D = 8.57 x 10 ⁻⁹
EN ISO 13849-1:2008	PL e, Cat. 4, PFH _D = 8.57 x 10 ⁻⁹
Electrical data	
Power supply	+24 VDC ± 20%
Power consumption, Active unit	2.5 W max (without load)
Cable length (for power supply)	70 m max
Outputs	2 PNP
Short-circuit protection	1.4 A at 55 °C
Output current	0.5 A max / output
Output voltage – ON	Power supply value less 1 V (min)
Output voltage – OFF	0.2 V max
Capacitive load	2.2 µF at +24 VDC max
Current for external lamp	20 mA min, 250 mA max
Response time	K1C-050: 11 ms, others: 12 ms
Connectors	M12-4 pole male on transmitter (compatible with M12-5 pole female)
Optical data	
Light emission (λ)	Infrared (860 nm)
Resolution	319.75 - 519.75 mm
Operating distance	0.5...8 m except K2C-090: 0.5...6.5 m
Ambient light rejection	According to IEC-61496-2:2013
Mechanical data	
Operating temperature	0...+ 55 °C
Storage temperature	- 25...+ 70 °C
Humidity range	15...95% (no condensation)
Protection class	IP65 (EN 60529:2000)
Housing material	Painted aluminium
Lens material	PMMA
Cap material	PBT Valox 508
Weight	
Orion3-4-K1C-050-E	1.3 kg
Orion3-4-K2C-080-E	1.8 kg
Orion3-4-K2C-090-E	2.1 kg
Orion3-4-K2C-120-E	2.6 kg
Orion3-4-M1C-050 (passive)	1.2 kg
Orion3-4-M2C-080 (passive)	1.7 kg
Orion3-4-M2C-090 (passive)	1.9 kg
Orion3-4-M2C-120 (passive)	2.5 kg

For more information about the connection accessories, see manual for:
Orion3 Extended [2TLC172292M0201](#)

Dimension drawings Orion3 Extended

Orion3 Extended

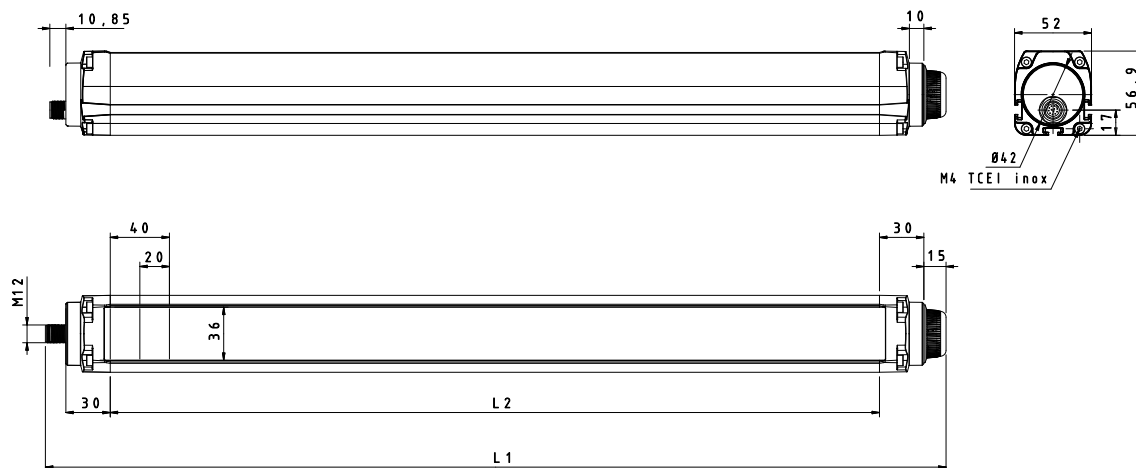

Active part - All dimensions in mm

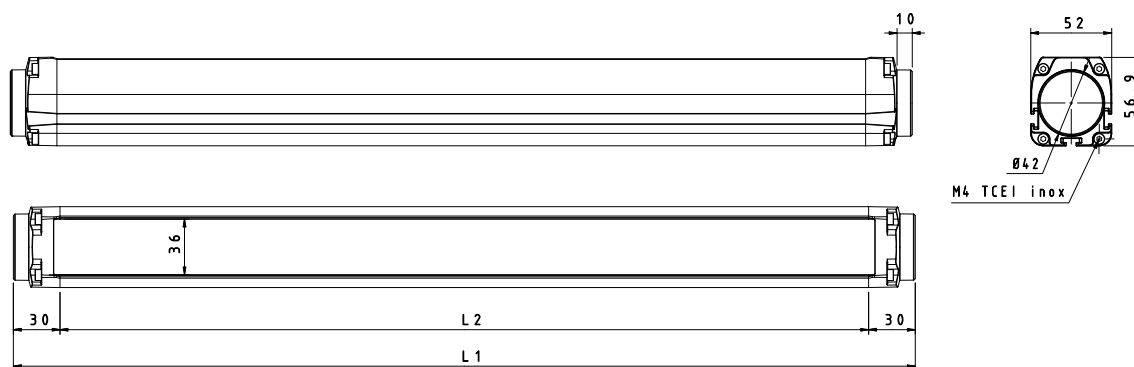

Passive part - All dimensions in mm

Dimensions

L1 mm	L2 mm	Type
606.4	520.5	Orion3-4-K1C-050-E (active part)
906.4	820.5	Orion3-4-K2C-080-E (active part)
1006.4	920.5	Orion3-4-K2C-090-E (active part)
1306.4	1220.5	Orion3-4-K2C-120-E (active part)
580.5	520.5	Orion3-4-M1C-050 (passive part)
880.5	820.5	Orion3-4-M2C-080 (passive part)
980.5	920.5	Orion3-4-M2C-090 (passive part)
1280.5	1220.5	Orion3-4-M2C-090 (passive part)

Safety light beam Spot

Spot is a light beam mainly used for body detection. It consists of a transmitter and a receiver. Infrared light is sent from the transmitter to the receiver and when the light beam is interrupted a stop signal is given to the dangerous machine.

Spot needs to be connected to Pluto safety PLC or Vital safety controller and can be used for distances up to 10 meter.



3

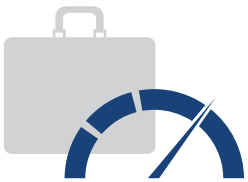

Speed up installation

Easy to place

Spot is very compact which makes it easy to place.

Easy cabling

M12 and Y connectors speed up the installation.

Minimal cabling

Up to 6 Spot light beams can be connected in series to Vital while maintaining PL e.

Accessories simplifies mounting

Brackets and mirrors simplify mounting and make it easy to create a suitable light beam setup.



Continuous operation

LED indication

LED indication shows if the units are in contact and simplifies alignment.

Information output

Information output reduces troubleshooting time.



Safety and protection

Highest safety level

Spot used together with Pluto or Vital achieves PL e according to EN ISO 13849.

Safe series connection

Easy to connect several Spot in series to make a multi-beam solution while still achieving PL e.

Applications and features

Spot

Applications

Perimeter guard

Spot can be used as a perimeter guard to detect if someone gets too close to the dangerous zone. Since spot only consists of one beam, the risk assessment has to decide if this is suitable for the safety function.

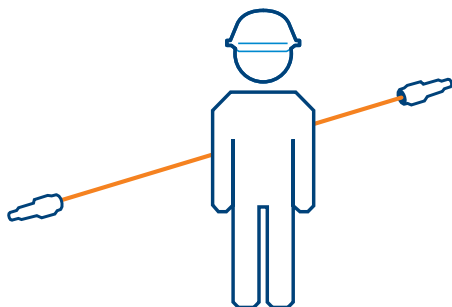

Complementary protective device

Spot is often used together with other protective devices, e.g. to detect someone standing on the wrong side (inside) of the protective device.

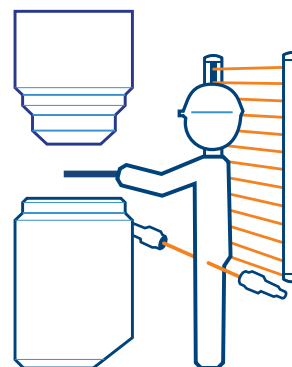

Features

Light beams

By using deflective mirrors, a suitable light beam setup can easily be created by just using one Spot transmitter and receiver pair. Spot has a sensing distance of 10 m, but each mirror used reduces the sensing distance by approximately 20%.

If longer distances or more beams are required, it is simple to connect up to 6 Spot light beams in series, while maintaining PL e.

Light beam adjustment

In environments with optical disturbances the power of the light beam can be adjusted using the trim potentiometer on the transmitter.

DYNlink solution

Spot uses the ABB Jokab Safety DYNlink signal that allows to connect several safety products in series while maintaining PL e using only one channel. DYNlink signals must be used with Vital safety controller or Pluto programmable safety controller. Up to 6 Spot can be connected in series to Vital and up to 2 Spot can be connected in series to one input of Pluto. All products using the DYNlink signal can easily be connected in series and mixed in the same loop with a maintained PL e. Tina adapters allow to use other products in a DYNlink loop, and a wide range of connection accessories simplify the cabling.

Info signal and extensive indication facilitate troubleshooting

Spot offers extensive LED indication to help troubleshooting and localizing which safety device has caused a stop. The LEDs on the Spot transmitter and receiver have the following functions:

transmitter green - power supply OK

receiver green - alignment OK, DYNlink circuit closed

receiver flashing - alignment OK, earlier DYNlink circuit open

receiver off - beam interrupted, DYNlink circuit open

Ordering information

Spot



Spot 10 T/R

2TLC172441F0201

Ordering details

Description	Type	Order code
Spot 10 T/R safety light beam, transmitter and receiver	Spot 10 T/R	2TLA020009R0600

Mounting accessories

Description	Type	Order code
Adjustable mounting bracket with rotational knuckle for 18 mm barrel style sensors.	JSM64	2TLA040007R0200
Bracket for JSM9 for vertical angling. Includes screws for profile.	JSM60-L	2TLA040003R0000
Bracket for JSM9 for horizontal angling around a machine. Includes screws for profile.	JSM62-L	2TLA040004R0000
Mirror for 0-20 m, adjustable mirror plate. Dimensions: 115 x 80 x 30 mm. Screws for bracket included.	JSM7A	2TLA040006R0500
Bracket for mirror.	JSM9	2TLA040007R0000
Wrench for tightening of M12 connectors according to specified torque: 0.6 Nm.	M12 Torque wrench	2TLA020053R0900
Aluminum post 44 x 44 x 1100 mm with 3 feet brackets and end caps.	JSMA44A-L	2TLA040001R1100

Connection accessories

Description	Type	Order code
Y-connector for series connection of DYNlink devices with M12-5 connectors, e.g. Spot	M12-3A	2TLA020055R0000
Y-connector for parallel connection of 2 DYNlink devices with M12-5 connectors, e.g. Spot	M12-3B	2TLA020055R0100

3

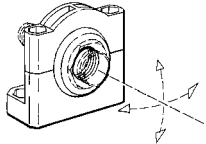

JSM64

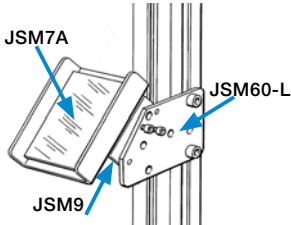

JSM7A

JSM60-L

JSM9

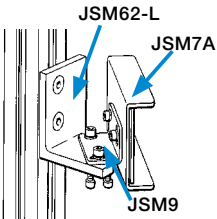

JSM62-L

JSM7A

JSM9

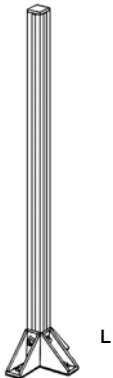

L

Cables and connections

Spot



M12-C61

2TLC172857F0201



M12-C61HE

2TLC010038F0201



M12-C01

2TLC172857F0201



C5 cable

2TLC010038F0201

Cable with connectors

Connector	Female/male	Length	Special feature	Type	Order code
M12-5	Female	6 m		M12-C61	2TLA020056R0000
			Harsh environment, halogen free	M12-C61HE	2TLA020056R8000
		10 m		M12-C101	2TLA020056R1000
	Female + male	20 m		M12-C101HE	2TLA020056R8100
			Harsh environment, halogen free	M12-C201	2TLA020056R1400
		0.3 m		M12-C0312	2TLA020056R5800
		0.06 m		M12-C00612	2TLA020056R6300
		1 m		M12-C112	2TLA020056R2000
		3 m		M12-C312	2TLA020056R2100
		6 m		M12-C612	2TLA020056R2200
10 m		M12-C1012	2TLA020056R2300		
	Angled female connector	M12-C1012V2	2TLA020056R6700		
16 m		M12-C1612	2TLA020056R5400		
20 m		M12-C2012	2TLA020056R2400		

Separate cables and connectors

Description	Type	Order code
Connectors		
M12-5 pole female, straight	M12-C01	2TLA020055R1000
M12-5 pole male, straight	M12-C02	2TLA020055R1100
Cable with 5 conductors		
10 m cable with 5 x 0.34 shielded conductors	C5 cable 10 m	2TLA020057R0001
50 m cable with 5 x 0.34 shielded conductors	C5 cable 50 m	2TLA020057R0005
100 m cable with 5 x 0.34 shielded conductors	C5 cable 100 m	2TLA020057R0010
200 m cable with 5 x 0.34 shielded conductors	C5 cable 200 m	2TLA020057R0020
500 m cable with 5 x 0.34 shielded conductors	C5 cable 500 m	2TLA020057R0050

Technical data

Spot

Technical data

Approvals	TÜV NORD 
Conformity	CE 2006/42/EC - Machinery 2004/108/EC - EMC EN ISO 12100:2010, EN ISO 13849-1:2008, EN 62061:2005, EN 61508:2010, EN 60204-1:2006+A1:2009, EN 61496-1:2004+A1:2008, EN 60664-1:2007, EN 61000-6-2:2005, EN 61000-6-4:2007
Functional safety data	
EN/IEC 61508:2010	SIL3, $PFH_D = 1.14 \times 10^{-8}$
EN/IEC 62061:2005+A1:2013	SILCL3, $PFH_D = 1.14 \times 10^{-8}$
EN ISO 13849-1:2008	PL e, Cat. 4, $PFH_D = 1.14 \times 10^{-8}$
EN/IEC 61496-1:2004	Type 4 with Vital/Pluto
Electrical data	
Operating voltage	+17...+27 VDC, ripple $\pm 10\%$ (SELV/PELV)
Mechanical data	
Operating temperature	-25...+65 °C
Protection class	IP67
Range	0 - 10 m
Installation	2 x M18 nuts (provided)
Cable connection	M12-4 male connector on the transmitter and M12-5 male connector on the receiver
Serial connection	
With Vital	Up to 6 Spot light beams can be connected in series while maintaining PL e.
With Pluto	2 Spot light beams can be connected in series on each Pluto input while maintaining PL e.

For more information about the connection accessories, see manual for:
Spot [2TLC172178M0201](#)

Dimension drawing

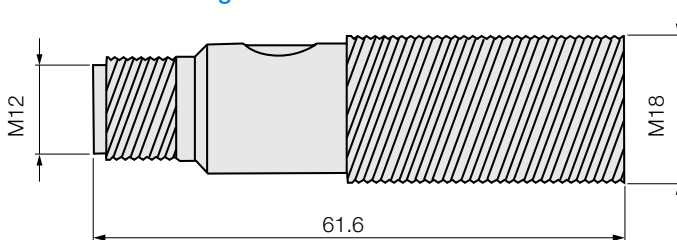

All dimensions in mm



Sensors and locks

Introduction and overview



Selection guide	4/2
Non-contact safety sensor – Eden	4/6
Safety interlock switch – MKey	4/14
Electromagnetic process lock – Magne	4/22
Process lock – Dalton	4/28
Safety and process lock – Knox	4/34



Introduction and overview

Selection guide

ABB has a full range of switches for monitoring doors and hatches, both with and without locking function.

4

	Eden	MKey
Image		
Function	Interlock	Interlock and process/safety lock
Type	Non-contact switch	Mechanical switch
Description	The original non-contact sensor with unique fault-detection capabilities.	A classic and well-tried solution.
Applications	Monitoring doors and hatches. Ideal for use in harsh environments such as food and beverage. Also for monitoring of end positions of e.g. an overhead crane.	Monitoring doors and hatches. Also available with safe locking.
Advantage	<ul style="list-style-type: none"> - Flexible mounting - M12 connectors - IP69K for harsh environments - One switch to reach Cat. 4 - Unique coding to prevent defeat - Local reset minimizes cabling - Non-contact eliminates wear 	<ul style="list-style-type: none"> - Holds the door closed - Possible to lock

	Magne	Dalton	Knox
Image			
Function	Interlock and process lock	Interlock and process lock	Interlock and safety lock
Type	Electromagnetic lock	Electromechanical lock	Electromechanical lock
Description	A robust magnetic lock with strong holding force.	A compact ball catch lock.	A robust lock with integrated handle
Applications	Locking doors and hatches to prevent interruption of machines with short stopping time e.g. robotics applications.	Locking small doors or hatches to prevent interruption of machines with short stopping time.	Safe locking of doors for machines with long stopping time.
Advantage	<ul style="list-style-type: none"> - Robust design for harsh environments - M12 connectors. 	<ul style="list-style-type: none"> - Compact - M12 connectors 	<ul style="list-style-type: none"> - Safe locking - Robust design - M12 connectors - Integrated door handle

Introduction and overview

Selection orientation

The difference between locking and interlocking functions

Interlocking function

An interlocking function indicates if a door is open or closed. When the door is open the interlocking function also prevents dangerous machine functions, but it does not prevent the door from being opened.



Interlocking function e.g. Eden

Locking function

A locking function prevents the door from being opened until an unlocking signal has been sent.



Locking function e.g. Magne

When to use interlocking and locking functions

An interlocking function is required if the dangerous machine functions needs to be stopped when someone enters the dangerous area.

A locking function is required if a user can open a door/hatch and reach the dangerous machine parts before the dangerous machine functions have ceased. It is also required if the process needs to be protected from unwanted stops that would occur if a person could open a door in the middle of a critical stage of the process..

The difference between a process lock and a safety lock

All locks of the ABB Jokab Safety range can be used as process locks but only Knox and the models of MKey that uses power to unlock can be used as safety locks. Here is why:

A **process lock** protects the process. One example of an application is a lock on a door giving access to a machine with short stopping time, e.g. a welding machine. The door should not be unlocked before the end of the welding cycle. Should the door be unlocked before the end of the cycle (as a consequence of a fault in the installation like a loss of power or a short-circuit) the door could be opened, which would result in a process stop. It might take a long time to restart the process, but no person would have had time to come close to the danger or get injured. Since the lock only protects the process there is no need for a safe locking signal.



Process lock e.g. Magne

A **safety lock** protects people. One example of an application is a lock on a door giving access to a dangerous machine with a long stopping time, e.g. a circular saw. The door should never be unlocked before the dangerous movement has stopped, not even as a consequence of a fault in the installation like a loss of power or a short-circuit. Should the door be unlocked before the machine has stopped, a person could open the door and have time to get close to the dangerous movement and get injured. Since the lock is protecting the person, the unlocking signal should be safe.

Since a loss of power should not unlock a safety lock, only locks that require power to unlock (e.g. +24 VDC) can be used as safety locks.



Safety lock e.g. Knox

Non-contact safety sensor Eden

Eden is a non-contact safety sensor used as interlocking device for e.g. doors and safe position monitoring.

Eden consists of two parts: Adam and Eva. Adam senses the presence of Eva without mechanical contact and therefore without any wear. The compact size of Eden and its 360° mounting possibility make it easy to use in most applications.

Different models of Eden are available for different types of control modules. All Eden models make it very easy to reach PL e, often using fewer components than other solutions.

All Eden models have an IP67/IP69K sealing.



4



Continuous operation

Easier troubleshooting

Extensive LED indication and status information reduce downtime.

Suitable in harsh environments

IP67/IP69K and a temperature range of -40 to +70°C offer an excellent resistance in demanding environments.

No wear, no mechanical breakage

Non-contact sensing means no mechanical wear and the large sensing tolerance gives a better tolerance to vibrations, resulting in fewer unwanted process stops.



Affordable range

Local reset function

The integrated reset function reduces the number of cables and PLC inputs.

PL e with fewer components

Series connection with PL e, local reset and DYNlink signal allow to considerably reduce the number of components needed to reach PL e.



Easy to install

Large mounting tolerance

A 360° mounting possibility with generous tolerances facilitates mounting.

Fast connection

M12 connectors, local reset and accessories speed up installation.

Applications

Eden

Applications

Doors and hatches

Eden monitors whether the hatch is open or closed. The dangerous movement is stopped as soon as the hatch is opened.

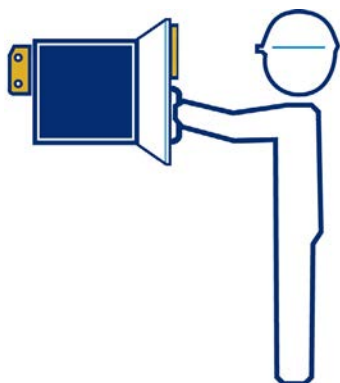

Position control

Eden can be used to monitor the position of a machine when someone is in the work area. This can be useful when removing power to the machine causes problems like a long restart time.

As long as the machine remains in the safe position monitored by Eden, a person can be allowed to enter the hazardous area even though the machine is still powered. If the machine leaves the safe position while the person is still in the hazardous area, power is removed from the machine.

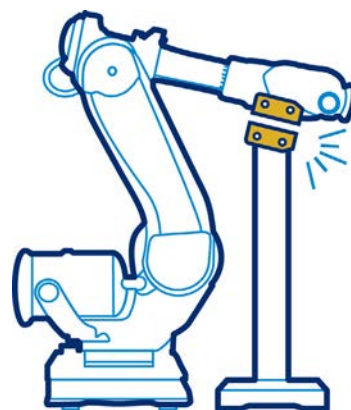

Features Eden

Features

Easy PL e with Eden safety sensor

- Eden sensors can be connected in series while maintaining Cat. 4.
- Only one Eden per guard is necessary to reach PL e (instead of two key switches).
- Eden reaches PL e without any need for periodic checks (see ISO/TR 24119).



Low or high level coded sensor

Eva is available with General code or Unique code. If a new Adam is paired with an Eva general code at start up, Adam will accept all Eva with general code as a valid actuator. Eden will then classify as a low level coded sensor. If a new Adam is paired with an Eva Unique code at startup (or Eva AS-i), Adam will only accept this specific Eva as a valid actuator. In this case Eden is classified as a high level coded sensor. A high level coded sensor should be used when the motivation to defeat a sensor cannot be eliminated (see EN ISO 14119:2013).

360° mounting possibility

Eden offers 360° mounting possibility with generous tolerances.

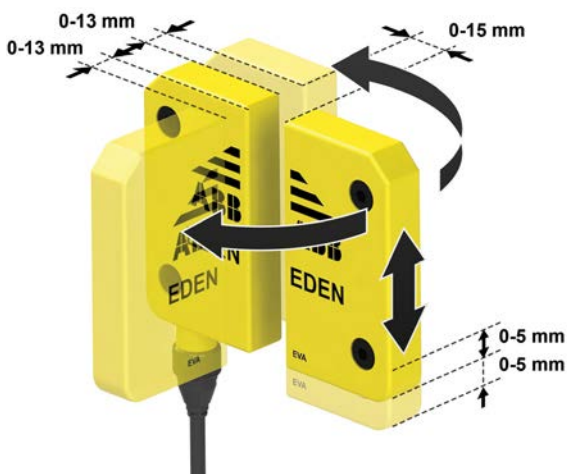

Local reset button

A local reset button with integrated LED can be connected directly to Adam Reset instead of to the safety control module. In this way, each Eden can easily have its own reset button, which saves cable length and safety relays/PLC inputs. Adam Reset monitors the reset function and manages the LED in the reset button in the following way:

- on** - Adam and Eva are not in contact
- flashing** - Adam and Eva in contact, waiting for reset
- off** - Adam and Eva in contact and reset

Info signal and extensive indication facilitate troubleshooting

All Eden models offer extensive LED indication to help troubleshooting and localizing which doors/hatches are opened. The LED on Adam lights in green or red depending on status:

- green** - valid Eva within range
- red** - valid Eva out of range
- flashing red/green** - valid Eva within range, but no valid safety signal received (loop broken "upstream")

The LED on Adam AS-i has slightly different default settings and can be programmed to light in any behaviour.

Simple status information with StatusBus

StatusBus is a simple and cost effective way to collect the status information of safety sensors. The StatusBus functionality is available with some DYNlink devices and allows to collect the status of each individual safety device, even when connected in series. A single input on Pluto safety PLC can collect the status of up to 30 safety devices. The devices are connected using standard cable and M12-5 connectors. No specific bus cable or extra communication module is necessary.

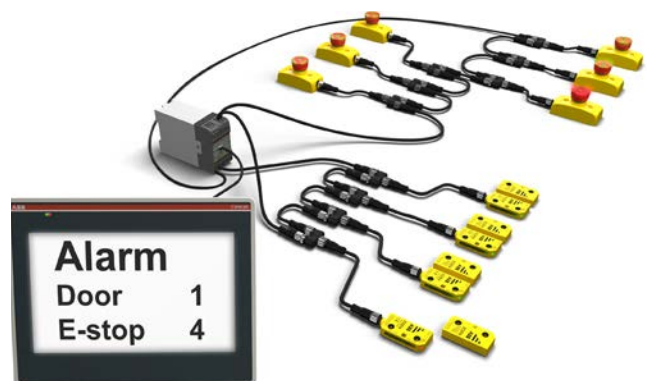

Models

Eden

Models

Eden DYN

Eden DYN consists of an Adam DYN and an Eva (general or unique code).

Adam DYN uses the ABB Jokab Safety DYNlink signal that allows to connect several safety products in series while maintaining PL e using only one channel. DYNlink signals must be used with Vital safety controller or Pluto safety PLC.

Up to 30 Adam DYN can be connected in series to Vital and up to 10 Adam DYN can be connected in series to one input of Pluto.

All products using the DYNlink signal can easily be connected in series and mixed in the same loop with a maintained PL e.

Tina adapters allow to use other products in a DYNlink loop, and a wide range of connection accessories simplifies the cabling.



Eden DYN

Eden AS-i

Eden AS-i consists of an Adam AS-i and an Eva AS-i (Eva AS-i has a unique code).

Eden AS-i can be used with any AS-i monitor. AS-i is a bus system that offers a very simple connection of up to 31 safety devices to one monitor according to PL e and makes it easy to move, remove and add safety devices.

When Eden AS-i is used with Pluto programmable safety controller, no other AS-i master or monitor is necessary, and no specific knowledge of AS-i is required.



Eden AS-i

Eden OSSD

Eden OSSD consists of an Adam OSSD and an Eva (general or unique code).

Adam OSSD can be used with all safety relays and safety PLCs compatible with OSSD signals (commonly used for light guards). Up to 30 Adam OSSD can be connected in series, and since OSSD devices monitor their own outputs for short circuits, a Cat. 4/PL e can still be reached.



Eden OSSD

Ordering information

Eden

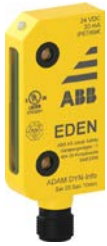

2TLA0010045V0201

Adam DYN-Info M12-5

4

Adam

Type of safety controller	StatusBus	Info signal	Local reset	Series connection	Connector male	Type	Order code
Pluto	x	x ¹⁾		x	M12-5	Adam DYN-Status M12-5	2TLA020051R5200
Pluto or Vital		x		x	M12-5	Adam DYN-Info M12-5	2TLA020051R5100
			x	x	M12-5	Adam DYN-Reset M12-5	2TLA020051R5300
OSSD compatible (incl. Pluto and Sentry)		x			M12-5	Adam OSSD-Info M12-5	2TLA020051R5400
			x	x	M12-8	Adam OSSD-Info M12-8	2TLA020051R5700
				x	M12-5	Adam OSSD-Reset M12-5	2TLA020051R5600
			x	x	M12-8	Adam OSSD-Reset M12-8	2TLA020051R5900
AS-i safety monitor (incl. Pluto AS-i and B42 AS-i)	N/A ²⁾	N/A ²⁾		N/A ²⁾	M12-4	Adam AS-i	2TLA020051R6000

1) Pin 5 can be used as a standard info signal or StatusBus.

2) AS-i offers the same advantages using another technology.



2TLA020046R0201

Eva General code

Eva

Compatible Adam	Code description	Code level	Type	Order code
Adam DYN and OSSD	General code. (Eva is interchangeable)	Low level	Eva General code	2TLA020046R0800
	Unique code. (Prevents defeat/fraud)	High level	Eva Unique code	2TLA020046R0900
Adam AS-i	Unique code. (Prevents defeat/fraud)	High level	Eva AS-i	2TLA020051R8000

Accessories

Description	Type	Order code
Mounting plate for conventional door/hatch and folding door. Two pieces are needed for a complete set.	JSM D4H	2TLA040033R3600
Mounting plate for folding doors. Used together with one piece of JSM D4H.	JSM D4J	2TLA042020R4000
Sliding lock for Eden on conventional doors. (Eden is not included.)	JSM D20	2TLA020302R1000
Mounting converting plate from Eden E to Eden OSSD or Eden DYN	DA 3A	2TLA020053R0600
Heat shrinking tubes for M12 connectors. Protects M12 connectors in harsh environments and provides extra protection against tampering.	M12 Safety seal	2TLA020053R0800
Safety screwdriver bit	SBIT Safety bit	2TLA020053R5000
Wrench for tightening of M12 connectors according to specified torque: 0.6 Nm.	M12 Torque wrench	2TLA020053R0900
Safety screw to eliminate the risk of manipulation/tampering. 1pc M4 x2 0mm. Length adapted to Eden.	Safety screw SM4 x 20	2TLA020053R4200
Handheld terminal for addressing, configuration and testing of AS-i devices, StatusBus devices, DYNlink devices and conventional PNP devices.	FIXA	2TLA020072R2000



2TLA010046R0201

JSM D20 Eden slide lock



2TLA010046R0201

FIXA

Spare parts (included with main product on delivery)

Description	Type	Order code
Distance plate in yellow PBT (4 pcs).	DA 1B	2TLA020053R0700
Black distance rings to be mounted in Adam and Eva mounting holes (4 pcs).	DA 2B	2TLA020053R0300



2TLA017272R0201

Distance plate

Reset buttons for local reset

Description	Type	Order code
Reset button for Adam with 5 pins	Smile 12RF	2TLA030053R2600
Reset button for Adam with 8 pins	Smile 12RG	2TLA030053R2700



2TLA017251R0201

Smile 12RG Reset button

Cables and connectors

Eden



M12-C61

2TLC172957F0201



M12-C61HE

2TLC010003F0201



M12-C334

2TLC172933F0201

Cable with connectors

Connector	Female/male	Length	Special feature	Type	Order code
M12-5 *	Female	6 m		M12-C61	2TLA020056R0000
		10 m	Harsh environment, halogen free	M12-C61HE	2TLA020056R8000
		10 m		M12-C101	2TLA020056R1000
		20 m	Harsh environment, halogen free	M12-C101HE	2TLA020056R8100
	Female + male	0.3 m		M12-C0312	2TLA020056R5800
		0.06 m		M12-C00612	2TLA020056R6300
		1 m		M12-C112	2TLA020056R2000
		3 m		M12-C312	2TLA020056R2100
		6 m		M12-C612	2TLA020056R2200
		10 m		M12-C1012	2TLA020056R2300
M12-8	Female	6 m		M12-C63	2TLA020056R3000
		10 m		M12-C103	2TLA020056R4000
		20 m		M12-C203	2TLA020056R4100
		0.06 m		M12-C00634	2TLA020056R6400
	Female + male	1 m		M12-C134	2TLA020056R5000
		3 m		M12-C334	2TLA020056R5100
			Angled female connector	M12-C1012V2	2TLA020056R6700
		16 m		M12-C1612	2TLA020056R5400
		20 m		M12-C2012	2TLA020056R2400
				M12-C0312	2TLA020056R5800

* Compatible with Adam AS-i

Separate cables and connectors

Description	Type	Order code
Connectors		
M12-5 pole female, straight	M12-C01	2TLA020055R1000
M12-5 pole male, straight	M12-C02	2TLA020055R1100
M12-8 pole female, straight	M12-C03	2TLA020055R1600
M12-8 pole male, straight	M12-C04	2TLA020055R1700

Cable with 5 conductors

10 m cable with 5 x 0.34 shielded conductors	C5 cable 10 m	2TLA020057R0001
50 m cable with 5 x 0.34 shielded conductors	C5 cable 50 m	2TLA020057R0005
100 m cable with 5 x 0.34 shielded conductors	C5 cable 100 m	2TLA020057R0010
200 m cable with 5 x 0.34 shielded conductors	C5 cable 200 m	2TLA020057R0020
500 m cable with 5 x 0.34 shielded conductors	C5 cable 500 m	2TLA020057R0050

Cable with 8 conductors

50 m cable with 8 x 0.34 shielded conductors	C8 cable 50 m	2TLA020057R1005
100 m cable with 8 x 0.34 shielded conductors	C8 cable 100 m	2TLA020057R1010
200 m cable with 8 x 0.34 shielded conductors	C8 cable 200 m	2TLA020057R1020
500 m cable with 8 x 0.34 shielded conductors	C8 cable 500 m	2TLA020057R1050



M12-C01

2TLC172857F0201



C5 cable

2TLC010038F0201



JSOP-2 Terminator

2TLC010038F0201



Connection accessories

Description	Type	Order code
Y-connector for series connection of DYNlink devices with M12-5 connectors, e.g. Eden.	M12-3A	2TLA020055R0000
Y-connector for series connection of DYNlink devices with the StatusBus function.	M12-3S	2TLA020055R0600
Y-connector for series connection of Adam OSSD M12-8 with M12-8 cables	M12-3G	2TLA020055R0700
Y-connector for series connection of Adam OSSD M12-8 with M12-5 cables	M12-3H	2TLA020055R0800
Termination plug M12-5. For Adam OSSD with M12-3H. Connects pin 1 with pin 2 and 4.	JSOP-1 Terminator	2TLA020053R7000
Termination plug M12-8. For Adam OSSD with M12-3G. Connects pin 2 with pin 3 and 4.	JSOP-2 Terminator	2TLA020053R7100
M12-5 female connector with vampire connector for AS-i flat cable	AS-i T-connector M12	2TLA020073R0000

Technical data

Eden

Technical data

	Eden DYN	Eden OSSD	Eden AS-i
Approvals			
Conformity	CE 2006/42/EC - Machinery 2014/30/EU - EMC 2011/65/EU - RoHS		
	EN ISO 12100:2010, EN ISO 13849-1:2008/AC:2009, EN62061:2005/A1:2013, EN60204-1:2006+A1:2009, EN 60664-1:2007, EN 61000-6-2:2005, EN 61000-6-4:2007, EN 60947-5-3:2013, EN ISO 14119:2013, EN 61508:2010	EN ISO 12100:2010, EN ISO 13849-1:2015, EN 62061:2005/A2:2015, EN 60204-1:2006+A1:2009, EN 60664-1:2007, EN 61000-6-2:2005, EN 61000-6-4:2007, EN 60947-5-3:2013, EN ISO 14119:2013, EN 61508:2010	EN ISO 12100:2010, EN ISO 13849-1:2008, EN 62061:2005, EN 60204-1:2006+A1:2009, EN 60664-1:2007, EN 61000-6-4:2007
Functional safety data			
EN/IEC 61508:2010	SIL3, PFH _D = 4.5 x 10 ⁻⁹	SIL3, PFH _D = 4.5 x 10 ⁻⁹	SIL3, PFH _D = 6.0 x 10 ⁻⁹
EN/IEC 62061:2005+A1:2013	SILCL3, PFH _D = 4.5 x 10 ⁻⁹	SILCL3, PFH _D = 4.5 x 10 ⁻⁹	SILCL3, PFH _D = 6.0 x 10 ⁻⁹
EN ISO 13849-1:2008	PL e, Cat. 4, PFH _D = 4.5 x 10 ⁻⁹	PL e, Cat. 4, PFH _D = 4.5 x 10 ⁻⁹	PL e, Cat. 4, PFH _D = 6.0 x 10 ⁻⁹
Electrical data	+24 VDC Tolerance: +14.4...+27.6 VDC	+24 VDC Tolerance: +14.4...+27.6 VDC	+30 VDC (AS-i bus) Tolerance: +26.5...+31.6 VDC
Mechanical data			
Operating temperature	-40 °C...+70 °C (storage/operation)	-40 °C...+70 °C (storage/operation)	-40 °C...+85 °C (storage), -25 °C...+55 °C (operation)
Protection class	IP67 and IP69K		
Humidity range	35 to 85% (no icing, no condensation)		
Material			
Housing	Polybutylene terephthalate (PBT)		
Moulding	Epoxy		
Weight	Eva: 70 g, Adam: 80 g		
Assured release distance (S _{ar})	25 mm	25 mm	45 mm
Assured operating distance (S _{ao})	10 mm	10 mm	7.5 mm
Rated operating distance (S _n)	15 ± 2mm		
Recommended distance between Adam and Eva	7 mm		
Min distance between two Eden	100 mm		

More information

For more information, e.g. the complete technical information, see product manual for:

Eden DYN [2TLC172271M0201](#)

Eden OSSD [2TLC172272M0201](#)

Eden AS-i [2TLC172230M0201](#)

Dimension drawings Eden

Dimension drawings

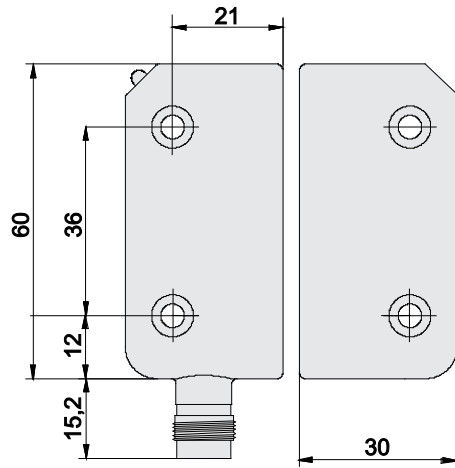

All dimensions in mm

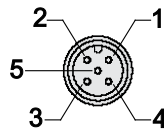
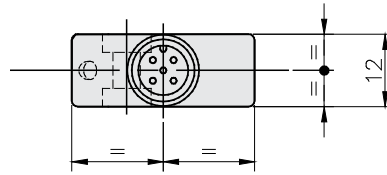

Adam M12-5 male connector.
(Note that some models have 4 or 8 pins instead.)

Safety interlock switch MKey

MKey are mechanical safety switches used for monitoring doors and hatches. The switch is mounted on the frame and the actuator key on the moving part of the guard.

All MKey models have a safe interlocking function. Some MKey models can be locked and depending on the locking signal they can be used either as process locks or safety locks (with a safe unlocking function).

MKey switches are available in different material and sizes in order to meet the requirements of different applications.



4



Safety and protection

Highest level of safety

PL e/SIL3 can be reached when using two switches on a door.

Safety lock

Models that use power to unlock can be used as safety locks.

Emergency escape button

Using MKey8ER with an integrated emergency escape button, it is always possible to open the door from inside the dangerous zone.



Continuous operation

Strong holding force

A holding force of up to 2000 N prevents unwanted process stops.

Robust design

Models are available with full stainless steel housing with IP69K, suitable for most applications in food processing and chemical industries.

Status information

Auxiliary contacts give status information.



Easy to install

Easy mounting with rotating head

The head of the switch can be mounted in up to 8 actuating positions to allow different mounting positions.

Flexible keys

Flexible keys are available to minimize mechanical wear and allow a smaller movement radius and use in reduced spaces.

Applications

MKey

Doors and hatches

MKey is used to monitor the position of doors and hatches.

The models with locking function are usually used for:

- Processes which should not be interrupted, such as welding.
- Machinery with a long stopping procedure, such as paper machinery that requires a long braking operation.
- Prevention of unauthorized access to a particular area.

Please note that all safety key switches (including MKey) normally need two switches per door/hatch in order to reach PL e/SIL3. (See EN ISO 13849 and EN ISO 14119.)

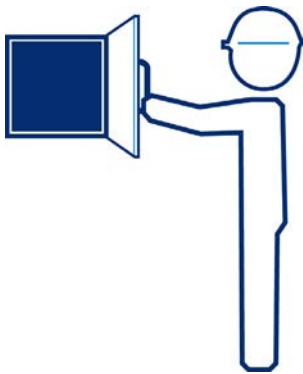

Locking and interlocking

An interlocking function indicates if a door is open or closed and prevents movement when the door is open, but it does not prevent the door from being opened. A locking function makes sure the door is kept closed.

Process lock with safe interlocking

All MKey models offer a safe interlocking function that will stop the process if the door/hatch is opened. All lockable models of MKey can also be used as a process lock to prevent the process from being interrupted.

An example of an application where a process lock could be used is a welding robot where the stopping time is short, but the welding should not be interrupted once it has started.

Safety lock with safe interlocking and safe unlocking

The MKey models that uses power to unlock can be used as safety locks. They have a safe unlocking function, which means that the loss of power for these locks will not result in the release of the locking element, and the door will remain locked even during a power failure.

An example of an application where a safety lock should be used is a circular saw that would have a long stopping time after a power failure.

Features

MKey

Different models

MKey5 are simple mechanical interlocks while MKey8 and MKey9 also have locking functions.

- MKey5: plastic body with plastic or stainless steel head, or full stainless steel body and head. Holding force 12 N or 40 N.
- MKey8: robust design in die cast metal or stainless steel body and head. Holding force of 2000 N.
- MKey9: plastic body with stainless steel head. Holding force of 1800 N.

Different materials and protection classes

The housing and head of the key switches are available in different material in order to meet the requirements of different applications. Metal heads are more resistant to mechanical wear. The choice between plastic, die cast or stainless steel depends on the environment and the chemicals used. Models ending with -Z are completely made of stainless steel 316 and offers an IP69K protection class. They can be high pressure hosed with detergent at high temperature and can be used in harsh applications, e.g. the food processing and chemical industries. All other models offer IP67.

Emergency escape button

MKey8ER has a manual release button at the rear of the housing. It is used for emergency exit by a person locked inside the dangerous zone by mistake. It is a non-latching manual escape, and can be used when the risk assessment requires it. The switch must be mounted so that the release button is reachable from inside the dangerous zone, but not reachable from outside. Pressing and holding the button will release the locking mechanism allowing to open the door/guard.



Power to lock or power to unlock

Two different types of locking function are available:

- Spring lock (power to unlock) models are automatically locked when closing the door. An active signal (+24 VDC) must be supplied to unlock the switch, which makes these models suitable as safe locks.
- Electro-magnetic lock (power to lock) models are locked when an active signal (+24 VDC) is supplied, which makes these models suitable only as process locks.

Rotatable head

Depending on model, the head of MKey can be set in two or four directions with two entrance holes each, thus providing four or eight different mounting positions. The leading edges of the actuator key are reinforced and beveled in order to guide it properly into the hole.



Constructed for safety

All MKey switches have double positively operated forced-guided contacts controlled by the actuator key. This means that the contacts that are closed when the actuator key is in the switch will be forced to open, and the ones that are opened will be forced to close, when the actuator key is removed. It also means that it is not possible to have, e.g. NO and NC contacts opened at the same time due to a fault like one welded contact.

The actuator key is designed to prevent tampering with the safety switch using a tool, a magnet or any similar object.

The lockable models also have forced-guided contacts controlled by the locking mechanism.

MKey8 and MKey9 have auxiliary contacts giving status information (not MKey5, MKey8M or MKey9M).

Ordering information

MKey



2TLC172403R0201

MKey5



2TLC172409R0201

MKey5 SSH



2TLC172503R0201

MKey5Z



2TLC172421R0201

MKey9



2TLC172417R0201

MKey8ER



2TLC172415R0201

MKey8Z

MKey ordering information

Locking function	Material housing	Material head	Holding force	Special feature	Type	Order code
—	Plastic	Plastic	12 N		MKey5	2TLA050003R0100
			40 N		MKey5+	2TLA050003R0101
		Stainless steel	12 N		MKey5 SSH	2TLA050003R0110
			40 N		MKey5+ SSH	2TLA050003R0111
	Stainless steel	Stainless steel	12 N	IP69K	MKey5Z	2TLA050003R0120
			40 N	IP69K	MKey5+Z	2TLA050003R0121
Process lock (power to lock)	Plastic	Stainless steel	1800 N		MKey9M 24VDC	2TLA050009R0112
	Die cast	Die cast	2000 N		MKey8M 24VDC	2TLA050013R0132
Safety lock (power to unlock)	Plastic	Stainless steel	1800 N		MKey9 24VDC	2TLA050007R0112
				No key supplied	MKey9 24VDC, No Key	2TLA050007R0012
	Die cast	Die cast	2000 N		MKey8 24VDC	2TLA050011R0132
				With escape release button	MKey8ER 24VDC	2TLA050015R0132
Stainless steel	Stainless steel	2000 N	IP69K	MKey8Z 24VDC	2TLA050011R0122	

Accessories

MKey



MKey Key 2

2TLA050040R0201



MKey Key 3

2TLA050040R0201



MKey Key 4

2TLA050040R0201



MKey Key 6



MKey slide lock left



MKey slide lock right

Actuator keys

All MKey safety switches are supplied with the appropriate standard key, except MKey9 24VDC, No key. Choose standard key or flat key depending on suitable mounting direction, e.g. standard door or sliding door. Flexible keys are suitable for doors/hatches with a smaller opening radius (i.e. 100-175 mm).

Type of key	Compatible MKey models	Key housing	Description	Type	Order code
Standard key	MKey5 MKey5+	None	Standard key for MKey safety switches with plastic head. Stainless steel key.	MKey Key 1	2TLA050040R0201
	MKey5 SSH MKey5+ SSH MKey5Z MKey5+Z All MKey8 All MKey9	None	Standard key for MKey safety switches with metal head. Stainless steel key.	MKey Key 2	2TLA050040R0202
Flat key	All	Plastic shroud	Flat key for MKey safety switches. Stainless steel key with plastic shroud.	MKey Key 3	2TLA050040R0220
Flexible key	All MKey5	Plastic	Flexible key for MKey5 safety switches. Stainless steel key with plastic housing.	MKey Key 4	2TLA050040R0221
	All	Die cast	Flexible key for MKey safety switches. Stainless steel key with black die cast metal housing.	MKey Key 5	2TLA050040R0203
	All	Stainless steel	Flexible key for MKey safety switches. Stainless steel key with stainless steel housing.	MKey Key 6	2TLA050040R0204

Other accessories

Description	Type	Order code
Bit for manual unlocking of MKey8Z. Stainless steel.	MKey8Z Manual release	2TLA050040R0400
Maintenance lockout actuator key. Compatible with all MKey switches.	MKey Lockout key	2TLA050040R0401
Slide Lock for MKey8 and MKey9, left.	MKey slide lock left	2TLA050040R0500
Slide Lock for MKey8 and MKey9, right.	MKey slide lock right	2TLA050040R0501
Spacer in stainless steel for flexible keys. Required when using JSM D29A and JSM D29C.	JSM D29E	2TLA040033R6400

Technical data

MKey

Technical data

	MKey5	MKey8	MKey9
Approvals			
Conformity	CE 2006/42/EC - Machinery 2014/30/EU - EMC 2011/65/EU - RoHS EN ISO 12100:2010, EN ISO 14119:2013, EN 60204-1:2006+A1:2009, EN 60947-1:2007+A1:2011, EN 60947-5-1:2004+A1:2009		
Functional safety data	B_{10d} EN/IEC 62061 EN ISO 13849-1		
	2,500,000 operations at 100 mA load Up to SILCL3 (depending on system architecture) ¹⁾ Up to PL e (depending on system architecture) ¹⁾		
Electrical data			
Contact block configuration with guard open and unlocked			
For actuator key	2 NO + 1 NC	MKey8, MKey8Z, MKey8ER: 2 NO + 1 NC MKey8M: 1 NO + 1 NC	MKey9: 2 NO + 1 NC ²⁾ 1 NO + 1 NC
For solenoid/locking	-	MKey8, MKey8Z, MKey8ER: 2NO + 1NC MKey8M: 2 NO	MKey9: 2 NO + 1 NC ²⁾ MKey9M: 2 NO
Solenoid voltage	-	+24 VDC ± 10%	+24 VDC ± 10%
DC-13	+24 VDC / 3 A		
AC-15	230 VAC / 3 A		
Mechanical data			
Travel for positive opening	6 mm	10 mm	10 mm
Actuator key entry minimum radius	175 mm Standard Key, 100 mm Flexible Key		
Material	Body: Polyester or stainless steel 316 Head: Polyester or stainless steel 316	MKey8, MKey8M, MKey8ER: Die cast painted red MKey8Z: Stainless steel 316	Body: Glass filled polyester Head: Stainless steel 316
Conduit entries	3 x M20 x 1.5	3 x M20 x 1.5	1 x M20 x 1.5
Operating temperature	-25...+80 °C	-25...+40 °C	-25...+40 °C
Protection class	MKey5, MKey5+, MKey5 SSH, MKey5+ SSH: IP67 MKey5Z, MKey5+Z: IP67, IP69K	MKey8, MKey8M, MKey8ER: IP67 MKey8Z: IP67, IP69K	IP67

1) Please see EN/IEC 62061, EN ISO 13849, EN ISO 14119 and ISO/TR 24119 to see how fault exclusions and serial connection impacts the reliability of the safety related parts of control systems.

2) For MKey9, the pair of contacts for the actuator key and the pair of contacts for the locking cannot be used independently of each other. See the manual for more information.

More information

For more information, e.g. the complete technical information, see product manual:

MKey5 [2TLC172244M0201](#)

MKey8 [2TLC172245M0201](#)

MKey9 [2TLC172246M0201](#)

Dimension drawings

MKey

MKey5

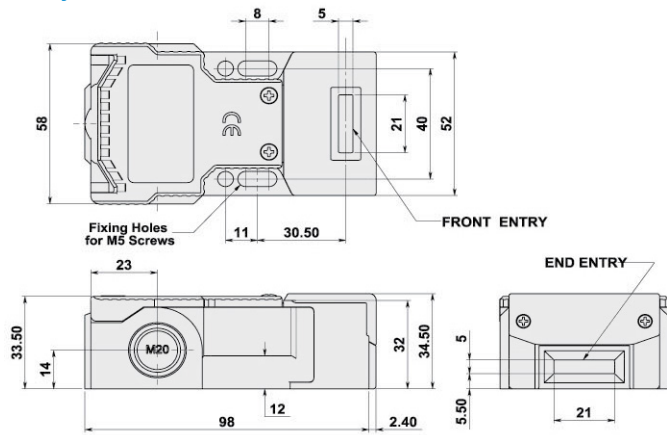

MKey8 and MKey8M

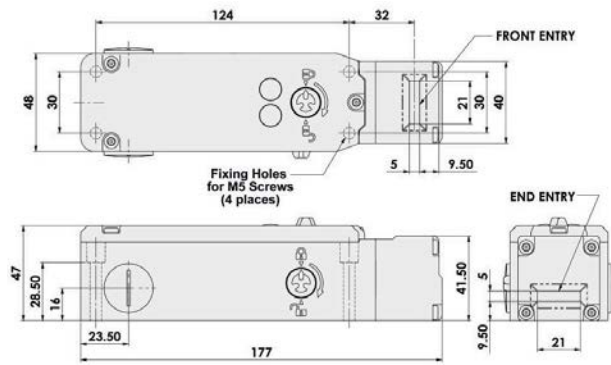

MKey8ER

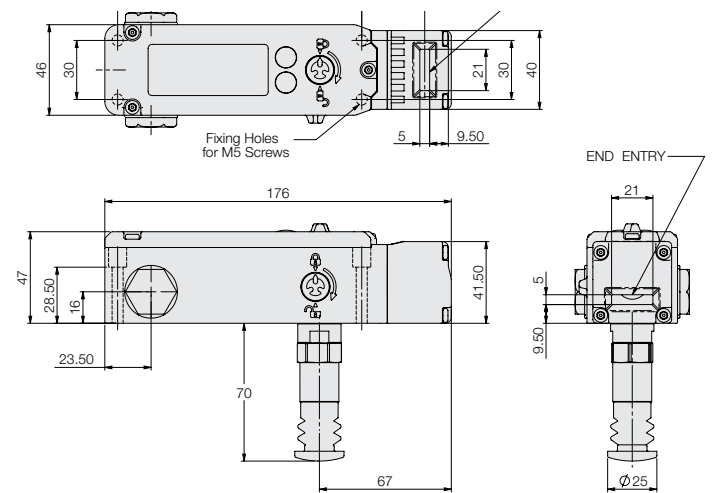

MKey9 and MKey9M

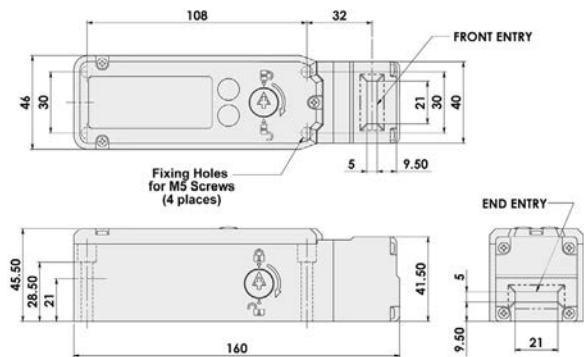

All dimensions in mm

Electromagnetic process lock

Magne

Magne is an electromagnetic process lock intended for locking doors and hatches.

Magne is usually used to prevent unwanted process interruptions, e.g. during a welding operation.

Magne models with integrated Adam safety sensor make it easy to achieve the highest safety level for the interlocking function.



4



Reliable in extreme conditions

Sealed aluminium housing

IP67 sealing makes Magne suitable for harsh environments.

Robust design

The electromagnetic lock without mechanical moving parts is a robust design with fewer parts that are subject to wear.

Hygienic design

Flat surfaces without cavities or screws sticking out minimize the risk of accumulating dirt on the surface.



Easy to install

M12 connectors

Quick and easy cabling with M12 connectors.

Magnets simplify installation

Electromagnets offer larger mounting tolerances than mechanical locks.



Continuous operation

LED diagnostics

Integrated LED diagnostics reduce down time when troubleshooting.

Strong holding force

A holding force of up to 1500 N prevents unwanted process stops.

Applications and features

Magne

Applications

Protect the process

Magne 4 is a process lock, with a safe interlocking function. This means that the interlocking function reaches PL e/SIL3 but the unlocking signal is not a safe signal. A typical application is to prevent unintentional/unnecessary interruptions of a sensitive process when the dangerous movement has a very short stop time.

Magne 3 is a simple lock without any interlocking function/safety function.

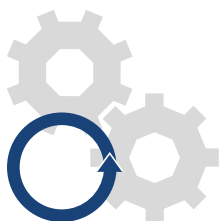

Harsh environments

With a hygienic enclosure in anodized aluminum and IP67 protection class, Magne is well suited for harsh environments.



4

Features

PL e in a simple and cost effective way

Magne 4 has an integrated Adam sensor. Models are available with either Adam DYN or Adam OSSD. Eva General code or Eva Unique code is ordered separately. The use of the Eden safety sensor makes it easy to reach PL e/SIL3 for the interlocking function, and enables serial connection of several Magne 4 locks to the Pluto safety PLC using only one input for Eden DYN and two for Eden OSSD. Tina 12A can be used for the serial connection of two Magne 4 locks in order to simplify connection, reduce cabling and risk of connection errors.



Optional permanent magnet

Anchor plates for Magne are ordered separately and are available with or without permanent magnet. A permanent magnet holds the door closed when Magne is unlocked, or if there is a power loss. Without the permanent magnet, Magne has no magnetic field when unlocked, which avoids the accumulation of metallic particles on the magnet.

M12 connectors

Since the Adam sensor is integrated in Magne 4, the amount of cables is reduced so that only one cable is necessary for both the locking of Magne and the interlocking with Eden. The M12 connectors speed up connection and reduce the risk of connection errors.



Status indication

Most models offer an info signal indicating whether the Magne is locked or not, which simplifies troubleshooting and improves user friendliness.

Locking and interlocking

An interlocking function indicates if a door is open or closed and prevents movement when the door is open. But it does not prevent the door from being opened. A locking function makes sure the door is kept closed.

Ordering information

Magne

4



Magne 3

2TLC010070V0201



Magne 4

2TLC010072V0201



Anchorplate

2TLC010085V0201



JSM D28

2TLC172167F0201

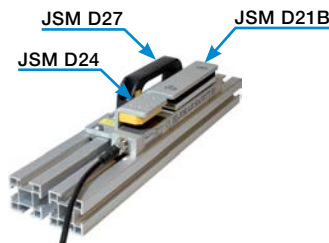

JSM D23



JSM D23



Tina 12A

2TLC172485F0201

Ordering details

For a complete Magne lock both door part and frame parts are necessary. Magne 4 also requires a separate Eva sensor.

Safe interlocking with integrated Adam	Safety signal	Extra function	Connector	Type	Order code
No	-	-	M12-5 male	Magne 3X M12-5	2TLA042022R2700
Yes	DYNlink	-	M12-5 male	Magne 4X DYN M12-5	2TLA042022R3000
		"Locked" and "Closed" information outputs	M12-8 male	Magne 4 DYN-Info	2TLA042022R3400
	OSSD	Local reset	M12-8 male	Magne 4 DYN-Reset	2TLA042022R4000
		"Locked" and "Closed" information outputs	M12-8 male	Magne 4 OSSD-Info	2TLA042022R4600
		Local reset	M12-8 male	Magne 4 OSSD-Reset	2TLA042022R5200

Accessories

Description	Type	Order code
Aluminium profile for door handle that completely covers a Magne unit when the door is closed. For conventional door (5–15 mm door gap)	JSM D28	2TLA042023R0100
Mounting kit for Magne. For conventional door (5–15 mm door gap) *	JSM D21B	2TLA042023R0500
Mounting kit for Magne. For sliding door *	JSM D23	2TLA042023R0200
Mounting kit for Eva. For conventional door*	JSM D24	2TLA042023R0300
Door handle for JSM D21B	JSM D27	2TLA042023R1000
Y-connector for serial connection of Magne 3	M12-3A	2TLA020055R0000
Connection block for serial connection of two Magne, Dalton or Knox (M12-8)	Tina 12A	2TLA020054R1800
Cellular rubber, 10 mm thick. Spare part for anchor plate.	Cellular rubber	2TLA042023R3600

* All mounting kits include the bolts and nuts necessary to mount Magne on ABB Quick-Guard® fencing system

Door part

Description	Type	Order code
Anchor plate with permanent magnet. Delivered with cellular rubber.	Magne Anchor 32B	2TLA042023R0400
Anchor plate without permanent magnet. Delivered with cellular rubber.	Magne Anchor 32A	2TLA042023R1300

Eva sensor for Magne 4 models

Compatible Adam	Code description	Code level	Type	Order code
Adam DYN and OSSD	General code. (Eva is interchangeable)	Low level	Eva General code	2TLA020046R0800
	Unique code. (Prevents defeat/fraud)	High level	Eva Unique code	2TLA020046R0900

Cables and connectors

Magne



M12-C61

2TLC172935F0201



M12-C61HE

2TLC010003F0201



M12-C334

2TLC172931F0201

Cable with connectors

Connector	Female/male	Length	Special feature	Type	Order code
M12-5	Female	6 m		M12-C61	2TLA020056R0000
			Harsh environment, halogen free	M12-C61HE	2TLA020056R8000
		10 m		M12-C101	2TLA020056R1000
			Harsh environment, halogen free	M12-C101HE	2TLA020056R8100
		20 m		M12-C201	2TLA020056R1400
				M12-C0312	2TLA020056R5800
	Female + male	0.3 m		M12-C00612	2TLA020056R6300
		0.06 m		M12-C112	2TLA020056R2000
		1 m		M12-C312	2TLA020056R2100
		3 m		M12-C612	2TLA020056R2200
		6 m		M12-C1012	2TLA020056R2300
		10 m	Angled female connector	M12-C1012V2	2TLA020056R6700
M12-8	Female	6 m		M12-C63	2TLA020056R3000
		10 m		M12-C103	2TLA020056R4000
		20 m		M12-C203	2TLA020056R4100
			M12-C00634	2TLA020056R6400	
	Female + male	0.06 m		M12-C134	2TLA020056R5000
		1 m		M12-C334	2TLA020056R5100
		3 m			



M12-C01

2TLC172657F0201



C5 cable

2TL0010039F0201

Separate cables and connectors

Description	Type	Order code
Connectors		
M12-5 pole female, straight	M12-C01	2TLA020055R1000
M12-5 pole male, straight	M12-C02	2TLA020055R1100
M12-8 pole female, straight	M12-C03	2TLA020055R1600
M12-8 pole male, straight	M12-C04	2TLA020055R1700
Cable with 5 conductors		
10 m cable with 5 x 0.34 shielded conductors	C5 cable 10 m	2TLA020057R0001
50 m cable with 5 x 0.34 shielded conductors	C5 cable 50 m	2TLA020057R0005
100 m cable with 5 x 0.34 shielded conductors	C5 cable 100 m	2TLA020057R0010
200 m cable with 5 x 0.34 shielded conductors	C5 cable 200 m	2TLA020057R0020
500 m cable with 5 x 0.34 shielded conductors	C5 cable 500 m	2TLA020057R0050
Cable with 8 conductors		
50 m cable with 8 x 0.34 shielded conductors	C8 cable 50 m	2TLA020057R1005
100 m cable with 8 x 0.34 shielded conductors	C8 cable 100 m	2TLA020057R1010
200 m cable with 8 x 0.34 shielded conductors	C8 cable 200 m	2TLA020057R1020
500 m cable with 8 x 0.34 shielded conductors	C8 cable 500 m	2TLA020057R1050

Technical data

Magne

Technical data

	Magne 3	Magne 4
Approvals		
Conformity	CE 2014/35/EU - Low voltage 2011/65/EU - RoHS	CE 2006/42/EC - Machinery 2014/30/EU - EMC 2011/65/EU - RoHS EN ISO 12100:2010, EN ISO 13849-1:2015, EN 62061:2005/A2:2015, EN 60204-1:2006+A1:2009, EN60664-1:2007, EN61000-6-2:2005, EN61000-6-4:2007+A1:2011, EN 60947-5-3:2013, EN ISO 14119:2013
Functional safety data	EN 61508:2010 EN 62061:2005 EN ISO 13849-1:2008	Interlocking function: SIL3, $PFH_d = 4.50 \times 10^{-9}$ Interlocking function: SILCL3, $PFH_d = 4.50 \times 10^{-9}$ Interlocking function: PL e, Cat. 4, $PFH_d = 4.50 \times 10^{-9}$
Electrical data		
Operating voltage	+24 VDC \pm 15%	
Holding force		
+24 VDC	Min 1500 N	
0 V, Anchor plate 32A	0 N	
0 V, Anchor plate 32B	30 N	
Mechanical data		
Mechanical life	$>10^7$ switch operations	
Operating temperature	-20...+50 °C	
Humidity range	35 to 85% (with no icing or condensation)	
Protection class	IP67	
Weight		
610 g		700 g
Anchor plate 32A/B	290 g	
Material		
Anchor plate	Iron with nickel coating	
Electromagnet	Iron with zinc-nickel coating	
Housing	Anodized aluminum with parts in polycarbonate	
Potting	PUR, epoxy	

More information

For more information, e.g. the complete technical information, see product manual for:

Magne [2TLC172315M0201](#)

Dimension drawings

Magne

Magne

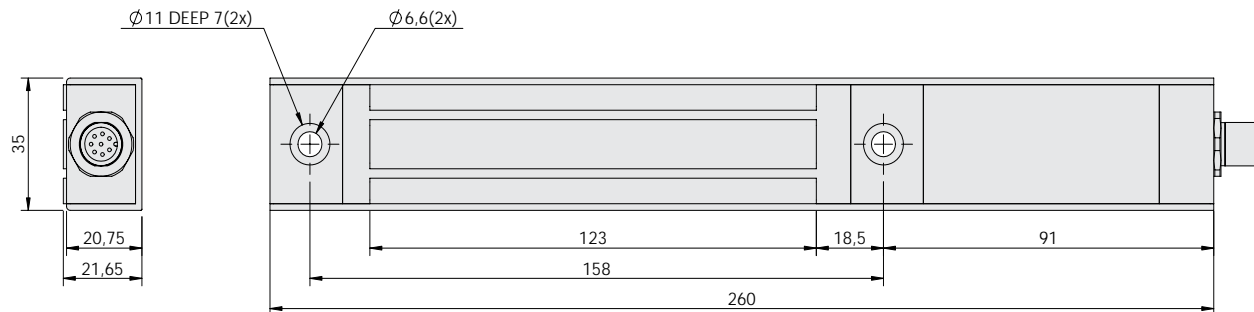

Anchor plate 32A

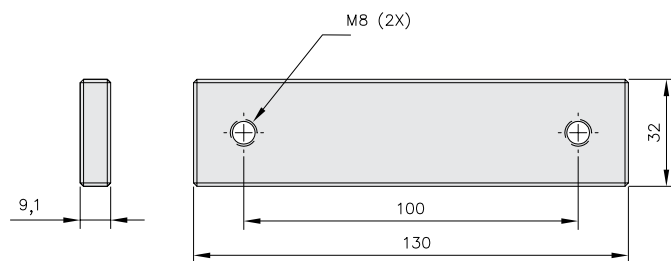

Anchor plate 32B

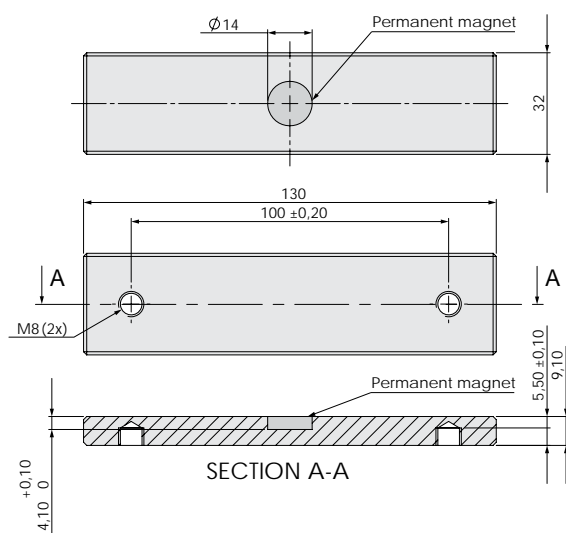

All dimensions in mm

Process lock Dalton

Dalton is a compact electromechanical lock intended for locking doors and hatches. In the unlocked state the hatch is held closed by a ball catch, and in locked state the balls are mechanically blocked so the hatch cannot be opened.

Dalton is usually used to prevent unwanted process interruptions, e.g. during a welding operation.

Dalton can be used alone or with an Eden safety sensor that makes it easy to achieve PL e/SIL3 for the interlocking function. Dalton is available with an M12-connector for direct connection of Eden, to reduce cabling.



4



Easy to install

M12 connectors

Quick and easy cabling with M12 connectors.

Compact size

Dalton is easy to fit due to its low weight and compact size.

Modular structure

Dalton has a modular structure and can be combined in different ways depending on position, installation and function.



Continuous operation

LED diagnostics

Integrated LED diagnostics reduces downtime when troubleshooting.

Robust design

With an IP64 enclosure in anodized aluminum and a tongue in stainless steel, Dalton keeps your machine running in demanding environments.



Safety and protection

Safety interlocking

Easy connection to Eden sensor enables the highest level of safety for the interlocking function.

Applications and features

Dalton

Applications

Protection of the process

When used with Eden safety sensor, Dalton is a process lock, since the Eden sensor provides a safe interlocking function. This means that the interlocking function can reach PL e/SIL3 but the unlocking signal is not a safe signal. A typical application is on a hatch to prevent unintentional/unnecessary interruptions of a sensitive process when the dangerous movement has a very short stop time.

Dalton without Eden is a lock without any interlocking function/safety function.

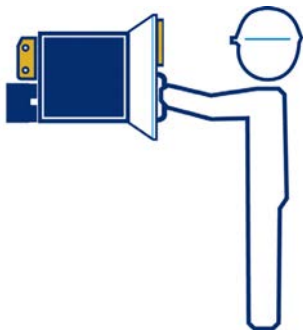

Locking and interlocking

An interlocking function indicates if a door is open or closed and prevents the machine from running when the door is open. But it does not prevent the door from being opened. A locking function makes sure the door is kept closed.

Features

PL e in a simple and cost effective way

The use of an Eden safety sensor together with Dalton makes it easy to reach PL e/SIL3 for the interlocking function. Eden can be mounted separately on the door/hatch or directly on Dalton M12. Both Eden DYN and Eden OSSD can be used.

When Eden DYN is used, a Tina 12A can be used to simplify the serial connection of two Dalton M12 locks. This reduces cabling and minimizes the risk of connection errors.

M12 connectors

Dalton M12 is equipped with an extra M12 connector for direct connection of an Eden safety sensor. This reduces cabling so that only one cable is necessary for both the locking of Dalton and the interlocking with Eden.

The M12 connectors speed up connection and reduce the risk of connection errors.



Status indication

All models offer an info signal indicating whether Dalton is locked or not, which simplifies troubleshooting and improves user friendliness.

Ordering information

Dalton

4



2TLA020038R3100

Dalton M11



2TLA020038R3300

Dalton M31



2TLA020038R3200

Dalton M12

Ordering details

Go through the three steps below in order to select the necessary parts of a complete Dalton lock.

1. Choose a lock housing

Connector for Adam	Type of connector	Type	Order code
No (only locking function)	M12-5 male ²⁾	Dalton M11	2TLA020038R3100
	M12-8 male ²⁾	Dalton M31	2TLA020038R3300
Yes ¹⁾	M12-8 male (+ M12-5 female for Adam)	Dalton M12	2TLA020038R3200

1) The compatible models are Adam DYN-Info M12-5, Adam DYN-Status M12-5, Adam OSSD-Info M12-5 and Adam OSSD-Reset M12-5.

2) Dalton M11 and Dalton M31 offer the same function and the same number of signals. The choice between the two is mainly depending on the type of cable that is standard on site, with 5 or 8 leads.

2. Choose a lock tongue

Description	Type	Order code
Door closing to the front of Dalton	Lock tongue A	2TLA020039R0800
Door closing to the upper or lower side of Dalton	Lock tongue B	2TLA020039R1000



Door closing to the front of Dalton - Tongue A

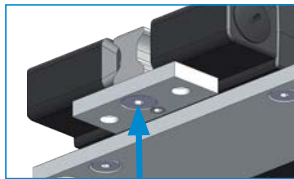

Door closing to the lower side of Dalton - Tongue B

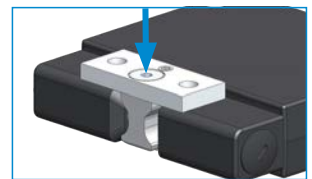

Door closing to the upper side of Dalton - Tongue B

3. Choose a fixing kit

Description	Type	Order code
For Dalton and lock tongue.	Dalton fixing kit 1	2TLA020039R0000
For Dalton and lock tongue plus Eden sensor.	Dalton fixing kit 2	2TLA020039R0100

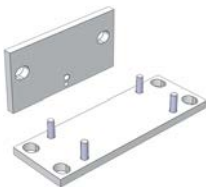

Fixing kit 1
For Dalton and lock tongue.
NOTE! Lock tongue is NOT included.

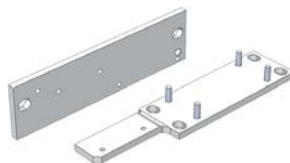

Fixing kit 2
For Dalton, lock tongue and Eden sensor.
NOTE! Eden and lock tongue are NOT included.

Cables and connectors

Dalton



M12-CT0214



Tina 12A



M12-C61



M12-C61HE



M12-C334



M12-C01



C5 cable

Accessories

Description	Type	Order code
Transfer cable M12-8 to M12-5, used e.g. for Dalton to Tina 4A or Tina 8A.	M12-CT0214	2TLA020060R0100
Connection block for series connection of two locks. E.g. Knox (M12-8), Magne or Dalton M12 with Eden DYN.	Tina 12A	2TLA020054R1800

Cable with connectors

Connector	Female/male	Length	Special feature	Type	Order code
M12-5	Female	6 m		M12-C61	2TLA020056R0000
			Harsh environment, halogen free	M12-C61HE	2TLA020056R8000
		10 m		M12-C101	2TLA020056R1000
			Harsh environment, halogen free	M12-C101HE	2TLA020056R8100
	Female + male	0.3 m		M12-C0312	2TLA020056R5800
			0.06 m	M12-C00612	2TLA020056R6300
		1 m		M12-C112	2TLA020056R2000
			3 m	M12-C312	2TLA020056R2100
		6 m		M12-C612	2TLA020056R2200
			10 m	M12-C1012	2TLA020056R2300
			Angled female connector	M12-C1012V2	2TLA020056R6700
			16 m	M12-C1612	2TLA020056R5400
M12-8	Female	6 m		M12-C63	2TLA020056R3000
		10 m		M12-C103	2TLA020056R4000
		20 m		M12-C203	2TLA020056R4100
	Female + male	0.06 m		M12-C00634	2TLA020056R6400
		1 m		M12-C134	2TLA020056R5000
		3 m		M12-C334	2TLA020056R5100

Separate cables and connectors

Description	Type	Order code
Connectors		
M12-5 pole female, straight	M12-C01	2TLA020055R1000
M12-5 pole male, straight	M12-C02	2TLA020055R1100
M12-8 pole female, straight	M12-C03	2TLA020055R1600
M12-8 pole male, straight	M12-C04	2TLA020055R1700

Cable with 5 conductors

10 m cable with 5 x 0.34 shielded conductors	C5 cable 10 m	2TLA020057R0001
50 m cable with 5 x 0.34 shielded conductors	C5 cable 50 m	2TLA020057R0005
100 m cable with 5 x 0.34 shielded conductors	C5 cable 100 m	2TLA020057R0010
200 m cable with 5 x 0.34 shielded conductors	C5 cable 200 m	2TLA020057R0020
500 m cable with 5 x 0.34 shielded conductors	C5 cable 500 m	2TLA020057R0050

Cable with 8 conductors

50 m cable with 8 x 0.34 shielded conductors	C8 cable 50 m	2TLA020057R1005
100 m cable with 8 x 0.34 shielded conductors	C8 cable 100 m	2TLA020057R1010
200 m cable with 8 x 0.34 shielded conductors	C8 cable 200 m	2TLA020057R1020
500 m cable with 8 x 0.34 shielded conductors	C8 cable 500 m	2TLA020057R1050

Technical data

Dalton

Technical data

Approvals	
Conformity	CE 2004/108/EC - EMC EN 61000-6-4:2007, EN 61000-6-2:2005
Functional safety data	
IEC/EN 61508-1...7	Interlocking function (with Eden): SIL3, PFH _D = 4.50 x 10 ⁻⁹
EN 62061	Interlocking function (with Eden): SILCL3, PFH _D = 4.50 x 10 ⁻⁹
EN ISO 13849-1	Interlocking function (with Eden): PL e, Cat. 4, PFH _D = 4.50 x 10 ⁻⁹
Electrical data	
Operating voltage	+24 VDC +25 / -20%
Holding force	
Unlocked	25-100 N
Locked	2000 N
Mechanical data	
Operating temperature	-10...+55 °C
Protection class	IP64
Material	
Ball catch, securing plate	Anodized aluminum
Enclosure	Anodized aluminum
Lock tongue, securing plate	Stainless steel

More information

For more information, e.g. the complete technical information, see product manual for:

Dalton [2TLC172165M0201](#)

Dimension drawings Dalton

Fixing kit 1 with Dalton

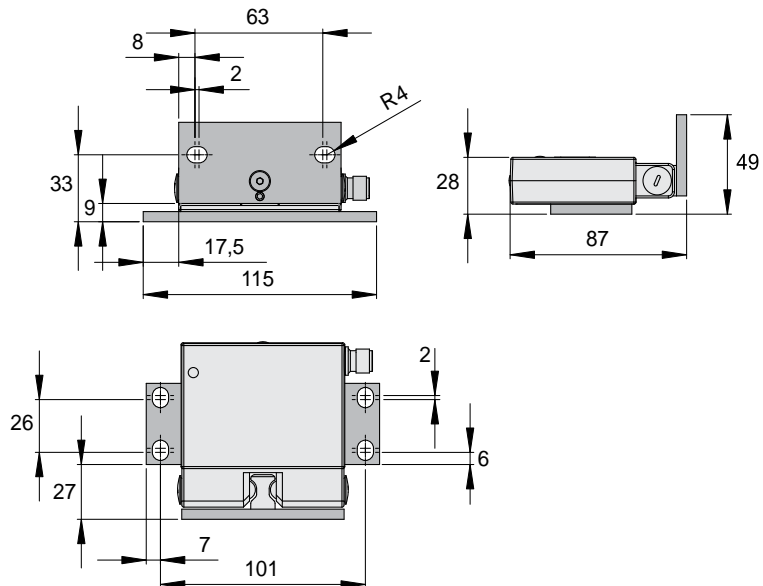

Fixing kit 2 with Dalton and Eden

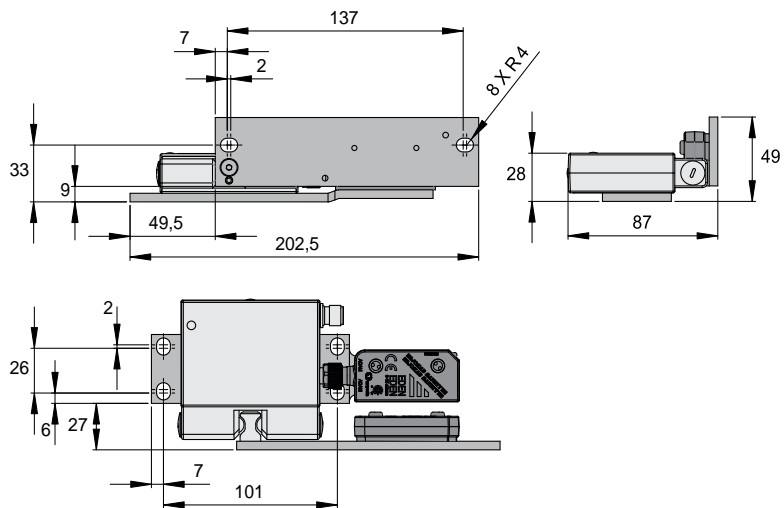

All dimensions in mm

Safety and process lock

Knox

Knox is a robust lock in stainless steel available in a variety of models: process locks and safety locks, and for most types of doors.

All Knox models offer an interlocking function reaching PL e/SIL3. Knox as safety lock also offers a locking/unlocking function reaching PL e/SIL3 while the locking/unlocking function of Knox as a process lock is not intended for safety functions.

Knox has a front handle and a red back handle. The handles on the lock operate as they would on a normal door, eliminating the needs of other handles for the door. But the front handle also offers a reset function, eliminating the need for a separate reset button, and the red back handle works as an emergency release/opening.



4



Safety and protection

Safe lock with double locking function

Both the locking function and the interlocking functions of Knox reach PL e/SIL3. Moreover, the mechanical locking is guaranteed by two separate latch bolts.

Emergency release handle on the inside

It is always possible to open the door from inside the dangerous zone, using the emergency release handle.



Continuous operation

LED diagnostics

Integrated LED diagnostics reduce down time when troubleshooting.

Strong holding force

A holding force of up to 5000 N prevents the door from being opened while the machine is running.



Reliable in extreme conditions

Robust design

Made of stainless steel and with a robust construction, Knox is ideal for use in mechanically demanding environments.

Applications and features

Knox

Process lock with safe interlocking

Knox 2X is a process lock, which means that the locking should not be used as a safety function. But it has a safe interlocking function that will stop the process if the door is opened.

Locking and interlocking

An interlocking function indicates if a door is open or closed and prevents movement when the door is open, but it does not prevent the door from being opened. A locking function makes sure the door is kept closed.

Several models

Several different models of Knox are available depending on if the door is left or right-hung, inward or outward opened, sliding door or with manual unlocking function.



Knox door part 1A-R
Right hung
Outwards opening

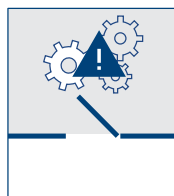

Knox door part 1B-R
Right hung
Inwards opening



Knox door part 1F-R
Sliding door
Slide right to open



Knox door part 1A-L
Left hung
Outwards opening



Knox door part 1B-L
Left hung
Inwards opening



Knox door part 1F-L
Sliding door
Slide left to open

Maintenance mode

There are holes in the two latch bolts for placing a padlock and preventing the door from closing/locking. This can be used e.g. by maintenance personnel to indicate the presence of a person inside the dangerous zone, and prevent unintended startup.

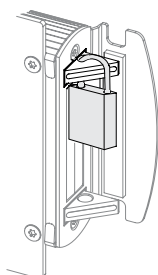

Safety lock with safe interlocking and safe unlocking

Knox 2A is a safety lock, which means that the unlocking function is suitable for safety functions, since it cannot be unlocked as a result of e.g. a short-circuit or a power loss. It also has a safe interlocking function that makes sure the machine won't start if the door is open.

Four different states

The front handle works as it would on a normal door with the addition that it offers a reset function when turned upwards, and the red back handle always offers an emergency release/opening. The following four combinations/states are possible.



Open



Emergency opened



Reset
Possible to open



Operational mode
Reset and locked, only emergency opening possible

Manual unlocking/Auxiliary release

In case of power loss, Knox remains in its state (locked or unlocked). Models with manual unlocking function offer the possibility to mechanically unlock Knox with a hex key. For all other models, it is necessary to apply power to unlock.

Ordering information

Knox

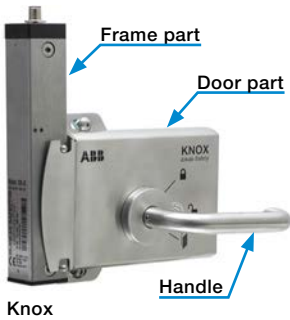

2TLC172435F0201

4

Knox

Door part

Type of opening	Manual unlocking	Right/left hung door	Type	Order code	
Outwards opening (away from the dangerous zone)	No	Right	Knox 1A-R v2	2TLA020105R5000	
		Left	Knox 1A-L v2	2TLA020105R5100	
	Yes	Right	Knox 1AX-R v2	2TLA020105R5800	
		Left	Knox 1AX-L v2	2TLA020105R5900	
Inwards opening (towards the dangerous zone)	No	Right	Knox 1B-R v2	2TLA020105R5200	
		Left	Knox 1B-L v2	2TLA020105R5300	
	Yes	Right	Knox 1BX-R v2	2TLA020105R6200	
		Left	Knox 1BX-L v2	2TLA020105R6300	
	Sliding door	No	Slide right to open	Knox 1F-R v2	2TLA020105R6000
			Slide left to open	Knox 1F-L v2	2TLA020105R6100
Yes		Slide right to open	Knox 1FX-R v2	2TLA020105R6400	
		Slide left to open	Knox 1FX-L v2	2TLA020105R6500	



2TLC172650F0201

Knox frame part

Frame part

Description	Connector	Type	Order code
Knox frame part for safety lock	M12-8 pole	Knox 2A v2	2TLA020105R2200
Knox frame part for process lock	M12-5 pole	Knox 2X v2	2TLA020105R2300



2TLC172031V0201

Knox PC plate

Accessories

Description	Type	Order code
PC plate for Knox on mesh door to prevent emergency opening from the outside through the mesh.	PC plate for Knox on mesh door	2TLA020106R0000
Cover plate to fit on the door part instead of the emergency release handle.	Escutcheon plate for Knox (without emergency release handle)	2TLA020106R0600
Connection block for serial connection of two Magne, Dalton or Knox (M12-8)	Tina 12A	2TLA020054R1800

Connectors

Description	Type	Order code
M12-5 pole female, straight	M12-C01	2TLA020055R1000
M12-8 pole female, straight	M12-C03	2TLA020055R1600

Cable with 5 conductors

Description	Type	Order code
10m cable with 5 x 0.34 shielded conductors	C5 10m	2TLA020057R0001
50m cable with 5 x 0.34 shielded conductors	C5 50m	2TLA020057R0005
100m cable with 5 x 0.34 shielded conductors	C5 100m	2TLA020057R0010
200m cable with 5 x 0.34 shielded conductors	C5 200m	2TLA020057R0020
500m cable with 5 x 0.34 shielded conductors	C5 500m	2TLA020057R0050
6 m cable with straight M12-5 female connector	M12-C61	2TLA020056R0000
10 m cable 5 with straight M12-5 female connector	M12-C101	2TLA020056R1000
20 m cable 5 with straight M12-5 female connector	M12-C201	2TLA020056R1400
6 m cable 5 with angled M12-5 female connector	M12-C61 V	2TLA020056R0100
10 m cable 5 with angled M12-5 female connector	M12-C101 V	2TLA020056R1100

Cable with 8 conductors

Description	Type	Order code
6 m cable with straight M12-8 female connector	M12-C63	2TLA020056R3000
10 m cable with straight M12-8 female connector	M12-C103	2TLA020056R4000
20 m cable with straight M12-8 female connector	M12-C203	2TLA020056R4100



2TLC172899F0201

Knox escutcheon plate



2TLC172489F0201

Tina 12A



2TLC172899F0201

Knox shear pin



Spare parts

Description	Type	Order code
Knox shear pin for handle	Knox shear pin	2TLA020106R0800
Extra seal labels for Knox with manual unlock. 10 pcs per package.	Knox man. unlock seal-label	2TLA020106R0800
Extra front silver handle	Knox silver handle	2TLA020106R0900
Extra back red handle	Knox red handle	2TLA020106R1000

Technical data

Knox

Technical data

Approvals	
Conformity	 2006/42/EC, 2004/108/EC EN ISO 12100:2010, EN ISO 13849-1:2008, EN 1088+A2:2008, EN 60204-1:2006+A1:2009, EN 61000-6-2:2005, EN 61000-6-4:2007, EN 61508:2010, EN 62061:2005+A1:2013
Functional safety data	
EN 61508:2010	Interlocking function: SIL3, $PFH_D = 4.50 \times 10^{-9}$
EN 62061:2005+A1:2013	Interlocking function: SILCL3, $PFH_D = 4.50 \times 10^{-9}$
EN ISO 13849-1:2008	Interlocking function: PL e, Cat. 4, $PFH_D = 4.50 \times 10^{-9}$ Locking function: PL e, Cat. 4
Electrical data	
Operating voltage	+24 VDC \pm 10%
Holding force	
Unlocked	5000 N (10 000 N ultimate breaking strength)
Locked	5000 N (10 000 N ultimate breaking strength)
Mechanical data	
Connection	Knox 2A: M12-8 pole male connector Knox 2X: M12-5 pole male connector
Lock function	Knox 2A: unlocked and locked with voltage Knox 2X: locked with voltage, unlocked when no voltage
Operating temperature	+5 °C...+55 °C
Protection class	IP65

More information

For more information, e.g. the complete technical information, see product manual:

Knox [2TLC172250M0201](#)

Dimension drawings

Knox

Knox 1A/B

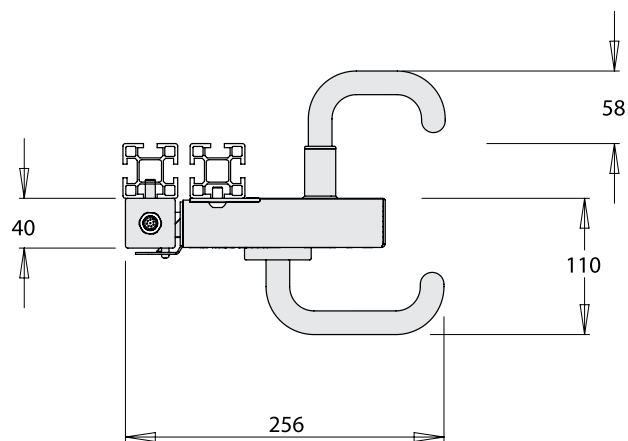
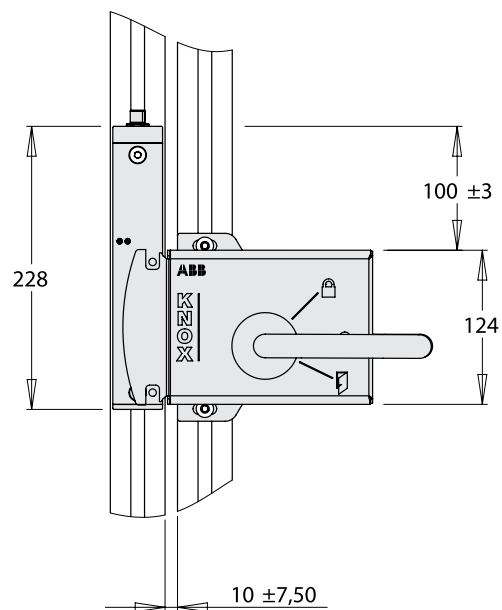

Knox 1F

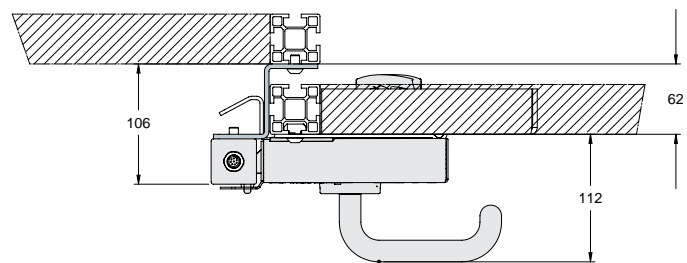
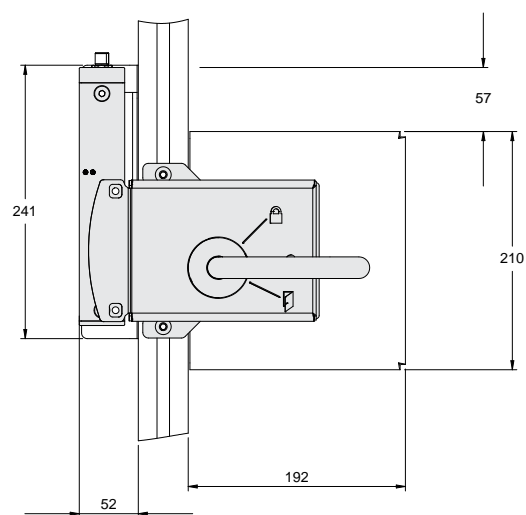

All dimensions in mm



Control devices

Introduction and overview



Selection guide	5/2
One- and two-hand devices – Safeball™	5/4
Three-position device – JSHD4	5/10

Introduction and overview

Selection guide

ABB offers ergonomic control devices that allow operators to safely control dangerous machinery.

5

	Safeball	JSHD4
Image		
Type	One or two-hand control device	Tree-position device
Description	Ergonomic and unique machine control	Ergonomic hold-to-run device with extra control buttons
Application	Mainly used in pairs as a two-hand control in applications where it must be ensured that the operator has his hands outside the hazardous area, e.g. for starting a press cycle.	Used during e.g. troubleshooting, test running and programming, in order to allow the operator to be inside the hazardous area without stopping the machine, while ensuring limited movement and stop in case of danger.
Advantages	<ul style="list-style-type: none"> - Ergonomic design - Several grip possibilities - Flexible mounting - Two opposing buttons minimize the possibility to defeat 	<ul style="list-style-type: none"> - Ergonomic shape and operation - Hand recognition prevents defeat - Easy connection with M12 connectors - Several models to suit multiple applications - Extra buttons for e.g. machine control

Introduction and overview

Selection orientation

Different types of control devices

When to use a two-hand or one-hand control device

A two-hand control device is often used for machines with manual loading or unloading. The operator uses the two-hand control device to safely start a machine cycle. A two-hand control must be used with a safety control device that supervises that both buttons are pressed simultaneously, i.e. both hands are on the control and therefore outside the dangerous zone, in order to start the dangerous movement.

An one-hand control device can be used in applications when the operator cannot reach the hazardous area with his/her free hand, or on less dangerous machines.



When to use a three-position device

A three-position device (or hold-to-run device) is used to allow a limited movement of the machine when the operator needs to be in the dangerous area without stopping the dangerous machine, for example during troubleshooting, test running or programming.

The operator pushes the larger black button to a middle position in order to allow a movement. In case of danger, the operator will either release the button or squeeze it to its bottom position and the machine will stop.

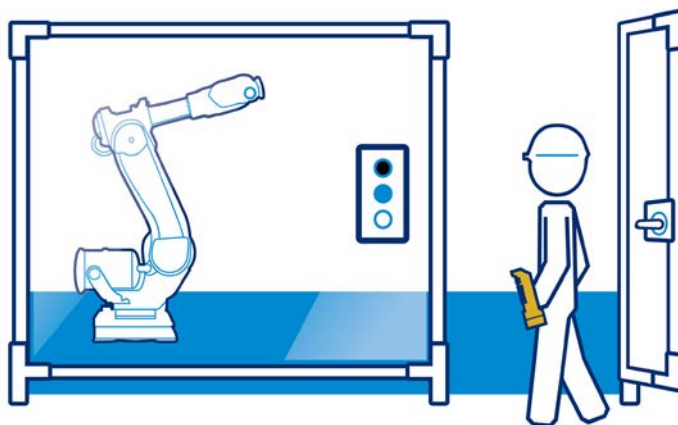

Standards

The safety distance of two-hand control devices should be calculated using EN ISO 13855.

When constructing a two-hand station for a machine, the standard EN 574 about functional aspects and principles for design needs to be followed.

One- and two-hand devices

Safeball™

Safeball™ is an ergonomic control device used for safe start and stop of machine cycles. Usually two Safeball™ are used together to form a two-hand control.

Safeball™ consists of a spherical ball containing two embedded push button switches, one on each side of the ball. Both buttons must be pressed in order to start and operate the machine. The risk of unintentional activation is thereby minimized and the device is simple and ergonomic to use.

When two Safeball™ are used in a two-hand device application, the operator must press all four push buttons simultaneously in order to operate the machine. If one or more of the buttons are released, a stop signal is given to the machine.



Optimum interface

Ergonomic design

The design of Safeball™ allows for comfort of use for all hand sizes and a great variety in gripping positions. And there is no need for shrouding top covers to prevent defeat, as there is for two-hand devices with standard push buttons.

Flexible mounting

With the JSM C5 mounting bracket, Safeball™ can be orientated in the most ergonomic position for the operator.



Safety and protection

Unique design

The unique design of Safeball™ combines the highest level of safety with the best ergonomics.

Highest safety level

Safeball™ provides the operator with a dual switching function and short-circuit supervision in each hand.

Applications and features

Safeball™

Applications

One-hand control device

One Safeball™ can be used as an ergonomic “hold to run” button, i.e. the movement is allowed as long as both push buttons on Safeball™ are pressed, usually when the operator cannot reach the hazardous area with his/her free hand, or on less dangerous machines. Safeball™ is a very practical one-hand control device since it is very easy to locate and activate.



Two-hand control device

A two-hand control device is often used for machines with manual loading or unloading. The operator uses the two-hand control device to safely start a machine cycle. A two-hand control must be used with a safety control device that makes sure that both buttons are pressed simultaneously, i.e. both hands are on the control and therefore outside the dangerous zone, in order to start the dangerous movement. Using two Safeball™, it is easy to realize a custom two-hand device.



5

Features

Mounting methods

Safeball™ can be mounted in many different ways. It can be mounted on a table, on the machine, on a support or wherever suitable for ergonomic reasons. Safeball™ can be mounted in a fixed position or on a tilting and/or rotating support when used with a JSM C5. This flexibility in mounting enhances ergonomics and minimizes work-related musculoskeletal disorders.

When two Safeball™ are used as a two-hand device, no shrouding top cover is necessary to prevent defeat, as it is for two-hand devices with push buttons, since it is very difficult to push all 4 push buttons of the two Safeball™ with e.g. a hand and an elbow.

Highest level of safety

When used as a two-hand control device, a safety controller for two-hand devices must be used, like an appropriate Sentry safety relay or a Pluto programmable safety controller. The safety controller monitors that all four push buttons (i.e. on each side of both Safeball™) are pressed within 0.5 second, in order to detect e.g. a short circuit or fraud, like a rubber band around one device. Safeball™ is certified to comply with type III C according to EN 574+A1:2008.

JSTD25

The JSTD25 control stations are pre-built two-hand devices utilizing the good ergonomics of Safeball™. They can be used as fixed devices that are easy to install, or as mobile devices. All models are equipped with shields to protect the buttons from accidental operation, and also protect from damage if the device is dropped on the floor when used as mobile device. All versions meet EN 574 and EN ISO 13849-1.



Ordering information

Safeball™



2TLC010041F0201

Safeball™



2TLC172685F0201

JSTD25F



2TLC172681F0201

JSTD25K



2TLC172194F0201

JSMC5

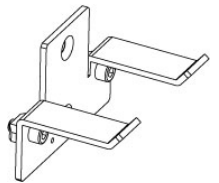

2TLC172198F0201

JSMC7

Safeball™ JSTD1

Types of switches	Cable length	Type	Order code
1 NO + 1 NC	2 m	JSTD1-A	2TLA020007R3000
	0.2 m	JSTD1-B	2TLA020007R3100
	10 m	JSTD1-C	2TLA020007R3200
2 NO	0.2 m	JSTD1-E	2TLA020007R3400

Two-hand control devices JSTD25

Extra feature	Connector male	Type	Order code
None	M12-5	JSTD25F	2TLA020007R6000
	M12-8	JSTD25H	2TLA020007R6300
Pre-mounted Smile 10 EA emergency stop button	M12-8	JSTD25K	2TLA020007R6900

Accessories

Description	Type	Order code
Mounting bracket for JSTD1 with orientation possibility (ball joint)	JSM C5	2TLA020007R0900
Suspension shelf for JSTD25F/H/K	JSM C7	2TLA020007R1200
Protection coat for Safeball	Safeball coat	2TLA020007R1900

Cables and connectors

Safeball™



M12-C61

2TLC172951F0201



M12-C61HE

2TLC010003F0201



M12-C334

2TLC172831F0201

Cable with connectors

Connector	Female/male	Length	Special feature	Type	Order code
M12-5	Female	6 m		M12-C61	2TLA020056R0000
		10 m	Harsh environment, halogen free	M12-C61HE	2TLA020056R8000
		10 m		M12-C101	2TLA020056R1000
		20 m	Harsh environment, halogen free	M12-C101HE	2TLA020056R8100
	Female + male	0.3 m		M12-C0312	2TLA020056R5800
		0.06 m		M12-C00612	2TLA020056R6300
		1 m		M12-C112	2TLA020056R2000
		3 m		M12-C312	2TLA020056R2100
		6 m		M12-C612	2TLA020056R2200
		10 m		M12-C1012	2TLA020056R2300
M12-8	Female	6 m		M12-C63	2TLA020056R3000
		10 m		M12-C103	2TLA020056R4000
		20 m		M12-C203	2TLA020056R4100
		20 m		M12-C2012	2TLA020056R2400
	Female + male	0.06 m		M12-C00634	2TLA020056R6400
		1 m		M12-C134	2TLA020056R5000
		3 m		M12-C334	2TLA020056R5100
		16 m	Angled female connector	M12-C1012V2	2TLA020056R6700

5



M12-C01

2TLC172657F0201



C5 cable

2TLC010098F0201

Separate cables and connectors

Description	Type	Order code
Connectors		
M12-5 pole female, straight	M12-C01	2TLA020055R1000
M12-5 pole male, straight	M12-C02	2TLA020055R1100
M12-8 pole female, straight	M12-C03	2TLA020055R1600
M12-8 pole male, straight	M12-C04	2TLA020055R1700
Cable with 5 conductors		
10 m cable with 5 x 0.34 shielded conductors	C5 cable 10 m	2TLA020057R0001
50 m cable with 5 x 0.34 shielded conductors	C5 cable 50 m	2TLA020057R0005
100 m cable with 5 x 0.34 shielded conductors	C5 cable 100 m	2TLA020057R0010
200 m cable with 5 x 0.34 shielded conductors	C5 cable 200 m	2TLA020057R0020
500 m cable with 5 x 0.34 shielded conductors	C5 cable 500 m	2TLA020057R0050
Cable with 8 conductors		
50 m cable with 8 x 0.34 shielded conductors	C8 cable 50 m	2TLA020057R1005
100 m cable with 8 x 0.34 shielded conductors	C8 cable 100 m	2TLA020057R1010
200 m cable with 8 x 0.34 shielded conductors	C8 cable 200 m	2TLA020057R1020
500 m cable with 8 x 0.34 shielded conductors	C8 cable 500 m	2TLA020057R1050

Technical data

Safeball™

Technical data

Approvals	Inspecta 
Conformity	CE 2006/42/EC - Machinery EN ISO 12100:2010, EN 574+A1:2008
Functional safety data	
EN/IEC 61508:2010	Up to SIL3, depending on system architecture
EN/IEC 62061:2005+A1:2013	Up to SILCL3, depending on system architecture
EN ISO 13849-1:2008	Up to Cat. 4, PL e, depending on system
Mechanical data	
Operating force	Approx. 2N
Life, mechanical	> 1 x 10 ⁶ operations at max 1 Hz
Connection cable	
JSTD1-A	PVC-cable, 4 x 0.75 mm ² , L = 2 m
JSTD1-B, JSTD1-E	Wires, 4 x 0.75 mm ² , L = approx. 0.2 m
JSTD1-C	PVC-cable, 4 x 0.75 mm ² , L = 10 m
Protection class	IP67. Not intended for use under water
Ambient temperature	-25 °C to +50 °C (operating)
Material JSTD1	Polypropylene
Weight JSTD1	
With 2 m cable	0.2 kg
With 10 m cable	0.7 kg
With 4 x 0.2 m wires	0.1 kg

More information

For more information, e.g. the complete technical information, see product manual for:
Safeball [2TLC172182M0201](#)

Dimension drawings Safeball™

Safeball™

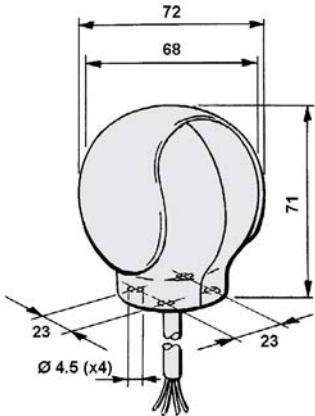

JSTD25F

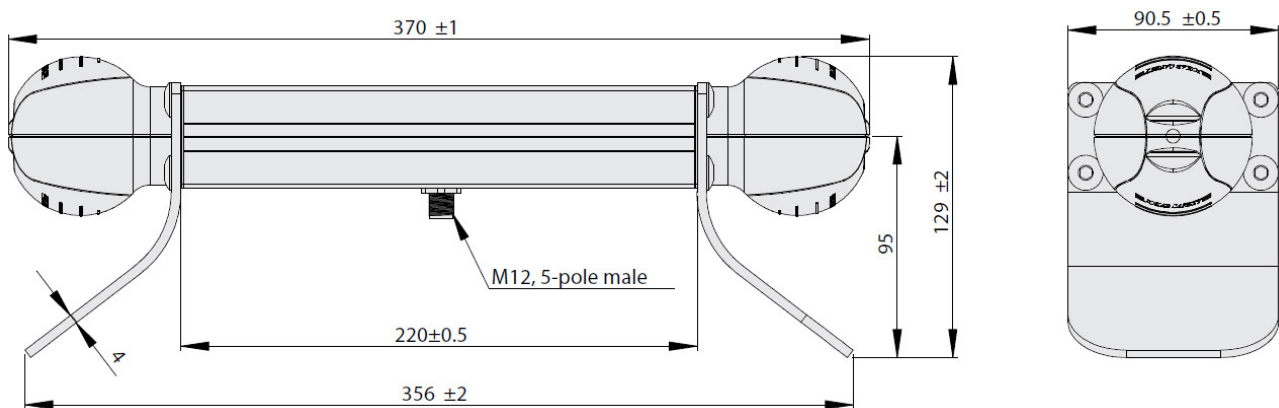

All dimensions in mm

Three-position device JSHD4

JSHD4 is a three-position device used to allow a limited movement of the machine when the operator is in the dangerous area, for example during troubleshooting, test running and programming.

The operator pushes the larger black button to a middle position in order to allow a movement. In case of danger, the operator will either release the button or squeeze it to its bottom position and the machine will stop.

JSHD4 is available with different types of connectors for an optimal adaptation to the application. Some models offer additional top and front button to control a non-safe signal, for ex. move forward and/or backward.



5



Safety and protection

Cheat-safe hand recognition

All JSHD4 models comply with PL e/Cat 4. Some models offer an “anti-tamper” function: an extra signal indicate if the JSHD4 is held in the middle position by a human hand. A machine movement will be authorized only in presence of this signal and not if the device is held in run position by any other (fraudulent) mean.



Optimum interface

Ergonomic shape and operation

JSHD4 is ergonomic, both in respect of its shape, fitting to the hand, and the way the buttons are operated. JSHD4 is easy to operate using just the fingers (even with gloves), and the middle position provides a safe resting position.



Continuous operation

Safely inspect a running machine

JSHD4 allows the operators to safely inspect the manufacturing process without completely stopping the machine.

Applications and features

JSHD4

Applications

Safe troubleshooting, programming and testing

If the operator has to enter a risk area for troubleshooting or test running, it is extremely important that he/she is able to stop the machinery without having to rely on someone else pushing a stop button. In addition, no-one else should be able to start the machinery after it has been stopped by the operator. An operator who is under pressure must also be able to give a stop signal, whether in panic he/she pushes harder on the button or just releases it.

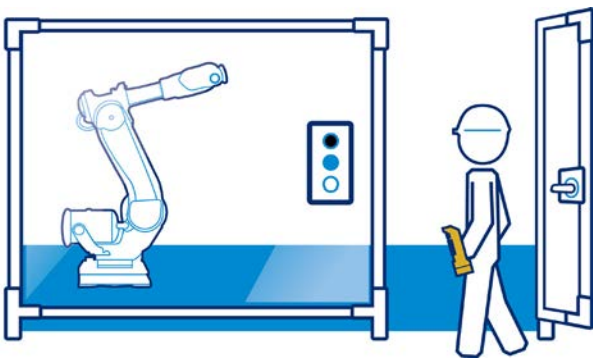

JSHD4 three-position control device can be used for troubleshooting, programming and test running in situations where no other protection is available or feasible. JSHD4 allows the operator to safely inspect the process without completely stopping the machine. The big black button has 3 distinct positions: released, pressed gently and pressed hard. The middle position allows the machine to run with limited speed or range, but when released or pressed hard the machine stops.

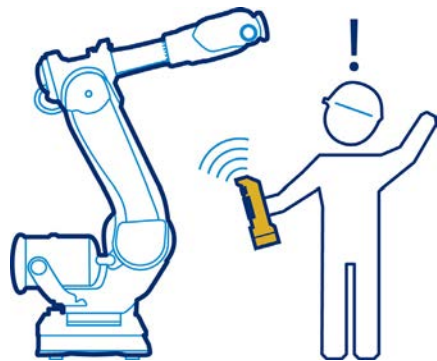

5

Features

Hand recognition for protection against tampering

An optional “anti-tamper” function sends an extra signal to indicate if the JSHD4 is held by a human hand or not. By using this, the safety level is increased, and the risk of manipulation or bypass of the safety function is reduced. It is no longer possible to expose the operator to danger by trying to lock the three-position control device in run mode.

Ergonomic design

JSHD4 is ergonomic, both in respect of its shape, fitting to the hand and the way the buttons are operated. It is easy to operate the device by using just the fingers (even with gloves), and the middle position provides a secure resting position.

Additional top and front buttons for non-safe signals

The two additional buttons can be used for e.g. start/stop, up/down or forward/ back. Internally the device is duplicated. The three-position function itself is built up of two completely independent three-position buttons which feels as one button for the user.

Ordering information

JSHD4

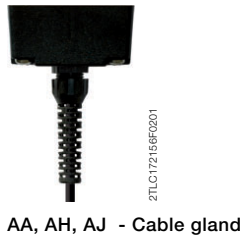
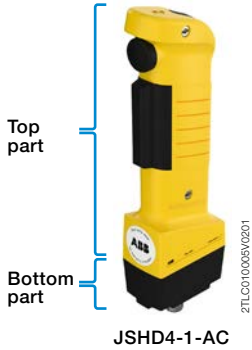

Choose top part, bottom part and anti-tamper

Top part Buttons and LEDs	Bottom part Feature	ID	Connection	Anti-tamper	Type	Order code
JSHD4-1	Use your own cable	AA	Cable gland and 5 screw connections		JSHD4-1-AA	2TLA019995R0000
	No LEDs No buttons	AC	M12-5 male		JSHD4-1-AC	2TLA019995R0100
	Holder for Eva (used with JSM54)	AL	Cable gland and 10 screw connections		JSHD4-1-AL	2TLA019995R4700
JSHD4-2	Cost effective and robust	AB	Cannon 12 male pins		JSHD4-2-AB	2TLA019995R0200
	LEDs Front button Top button	AD	M12-8 male	x	JSHD4-2-AB-A	2TLA019995R0300
		AD	M12-8 male	x	JSHD4-2-AD	2TLA019995R0400
	Use your own cable, simplified connection	AD	M12-8 male	x	JSHD4-2-AD-A	2TLA019995R0500
		AH	Cable gland and 10 screw connections	x	JSHD4-2-AH	2TLA019995R0800
	Use your own cable, full pin connection	AH	Cable gland and 10 screw connections	x	JSHD4-2-AH-A	2TLA019995R0900
		AJ	Cable gland and 16 screw connections	x	JSHD4-2-AJ	2TLA019995R1000
	Replacement of old units*	AJ	Cable gland and 16 screw connections	x	JSHD4-2-AJ-A	2TLA019995R1100
	Replacement of old units*	AK	Cannon 12 male pins		JSHD4-2-AK	2TLA019995R4800
	Holder for Eva (used with JSM54)	AL	Cable gland and 10 screw connections	x	JSHD4-2-AL	2TLA019995R4900
Holder for Eva (used with JSM54)	AL	Cable gland and 10 screw connections	x	JSHD4-2-AL-A	2TLA019995R5000	
JSHD4-3	Cost effective and robust	AB	Cannon 12 male pins		JSHD4-3-AB	2TLA019995R1200
	LEDs No buttons	AD	M12-8 male	x	JSHD4-3-AB-A	2TLA019995R1300
		AD	M12-8 male	x	JSHD4-3-AD	2TLA019995R1400
	E-stop	AE	M12-8 male	x	JSHD4-3-AD-A	2TLA019995R1500
	Use your own cable, simplified connection	AE	M12-8 male	x	JSHD4-3-AE	2TLA019995R1600
		AH	Cable gland and 10 screw connections	x	JSHD4-3-AH	2TLA019995R2000
	Use your own cable, full pin connection	AH	Cable gland and 10 screw connections	x	JSHD4-3-AH-A	2TLA019995R2100
		AJ	Cable gland and 16 screw connections	x	JSHD4-3-AJ	2TLA019995R2200
	Replacement of old units*	AJ	Cable gland and 16 screw connections	x	JSHD4-3-AJ-A	2TLA019995R2300
	Replacement of old units*	AK	Cannon 12 male pins		JSHD4-3-AK	2TLA019995R5100
Holder for Eva (used with JSM54)	AL	Cable gland and 10 screw connections	x	JSHD4-3-AL	2TLA019995R5200	
Holder for Eva (used with JSM54)	AL	Cable gland and 10 screw connections	x	JSHD4-3-AL-A	2TLA019995R5300	
JSHD4-4	Cost effective and robust	AB	Cannon 12 male pins		JSHD4-4-AB	2TLA019995R2400
	LEDs Front button	AD	M12-8 male	x	JSHD4-4-AB-A	2TLA019995R2500
		AD	M12-8 male	x	JSHD4-4-AD	2TLA019995R2600
	Use your own cable, simplified connection	AD	M12-8 male	x	JSHD4-4-AD-A	2TLA019995R2700
		AH	Cable gland and 10 screw connections	x	JSHD4-4-AH	2TLA019995R3000
	Use your own cable, full pin connection	AH	Cable gland and 10 screw connections	x	JSHD4-4-AH-A	2TLA019995R3100
		AJ	Cable gland and 16 screw connections	x	JSHD4-4-AJ	2TLA019995R3200
	Replacement of old units*	AJ	Cable gland and 16 screw connections	x	JSHD4-4-AJ-A	2TLA019995R3300
	Replacement of old units*	AK	Cannon 12 male pins		JSHD4-4-AK	2TLA019995R5400
	Holder for Eva (used with JSM54)	AL	Cable gland and 10 screw connections	x	JSHD4-4-AL	2TLA019995R5500
Holder for Eva (used with JSM54)	AL	Cable gland and 10 screw connections	x	JSHD4-4-AL-A	2TLA019995R5600	
JSHD4-5	Cost effective and robust	AB	Cannon 12 male pins		JSHD4-5-AB	2TLA019995R3400
	LEDs Top button	AD	M12-8 male	x	JSHD4-5-AB-A	2TLA019995R3500
		AD	M12-8 male	x	JSHD4-5-AD	2TLA019995R3600
	Use your own cable, simplified connection	AD	M12-8 male	x	JSHD4-5-AD-A	2TLA019995R3700
		AH	Cable gland and 10 screw connections	x	JSHD4-5-AH	2TLA019995R4000
	Use your own cable, full pin connection	AH	Cable gland and 10 screw connections	x	JSHD4-5-AH-A	2TLA019995R4100
		AJ	Cable gland and 16 screw connections	x	JSHD4-5-AJ	2TLA019995R4200
	Replacement of old units*	AJ	Cable gland and 16 screw connections	x	JSHD4-5-AJ-A	2TLA019995R4300
	Replacement of old units*	AK	Cannon 12 male pins		JSHD4-5-AK	2TLA019995R5700
	Holder for Eva (used with JSM54)	AL	Cable gland and 10 screw connections	x	JSHD4-5-AL	2TLA019995R5800
Holder for Eva (used with JSM54)	AL	Cable gland and 10 screw connections	x	JSHD4-5-AL-A	2TLA019995R5900	

* See document [2TLC010007L0201](#) for information about replacement

Cables and connectors

JSHD4



M12-C61

2TLC172951F0201



M12-C61HE



M12-C334

2TLC172981F0201



HK20S4

Cable with connectors

Connector	Female/male	Length	Special feature	Type	Order code
M12-5	Female	6 m		M12-C61	2TLA020056R0000
			Harsh environment, halogen free	M12-C61HE	2TLA020056R8000
		10 m		M12-C101	2TLA020056R1000
			Harsh environment, halogen free	M12-C101HE	2TLA020056R8100
				M12-C201	2TLA020056R1400
				M12-C0312	2TLA020056R5800
	Female + male	0.3 m		M12-C00612	2TLA020056R6300
		0.06 m		M12-C112	2TLA020056R2000
		1 m		M12-C312	2TLA020056R2100
		3 m		M12-C612	2TLA020056R2200
		6 m		M12-C1012	2TLA020056R2300
		16 m		M12-C1612	2TLA020056R5400
		20 m		M12-C2012	2TLA020056R2400
M12-8	Female	6 m		M12-C63	2TLA020056R3000
		10 m		M12-C103	2TLA020056R4000
		20 m		M12-C203	2TLA020056R4100
	Female + male	0.06 m		M12-C00634	2TLA020056R6400
		1 m		M12-C134	2TLA020056R5000
		3 m		M12-C334	2TLA020056R5100
Cannon	Female	5 m		HK5	2TLA020003R4700
		10 m		HK10	2TLA020003R4800
		20 m		HK20	2TLA020003R4900
		2 m	Spiral cable	HK20S4	2TLA020003R5100
		3.2 m	Spiral cable	HK32S4	2TLA020003R5200
		4 m	Spiral cable	HK40S4	2TLA020003R3500
		6 m	Spiral cable	HK60S4	2TLA020003R3600
		8 m	Spiral cable	HK80S4	2TLA020003R5300

5



M12-C01

2TLC172957F0201



C5 cable

2TLC010038F0201

Separate cables and connectors

Description	Type	Order code
Connectors		
M12-5 pole female, straight	M12-C01	2TLA020055R1000
M12-5 pole male, straight	M12-C02	2TLA020055R1100
M12-8 pole female, straight	M12-C03	2TLA020055R1600
M12-8 pole male, straight	M12-C04	2TLA020055R1700
12-pole female cannon connector for JSHD4	JSHK0	2TLA020003R0300

Cable with 5 conductors

10 m cable with 5 x 0.34 shielded conductors	C5 cable 10 m	2TLA020057R0001
50 m cable with 5 x 0.34 shielded conductors	C5 cable 50 m	2TLA020057R0005
100 m cable with 5 x 0.34 shielded conductors	C5 cable 100 m	2TLA020057R0010
200 m cable with 5 x 0.34 shielded conductors	C5 cable 200 m	2TLA020057R0020
500 m cable with 5 x 0.34 shielded conductors	C5 cable 500 m	2TLA020057R0050

Cable with 8 conductors

50 m cable with 8 x 0.34 shielded conductors	C8 cable 50 m	2TLA020057R1005
100 m cable with 8 x 0.34 shielded conductors	C8 cable 100 m	2TLA020057R1010
200 m cable with 8 x 0.34 shielded conductors	C8 cable 200 m	2TLA020057R1020
500 m cable with 8 x 0.34 shielded conductors	C8 cable 500 m	2TLA020057R1050

Accessories JSHD4

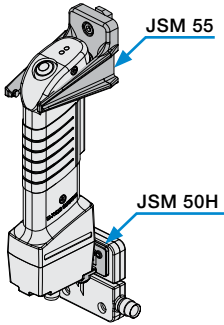

JSM 55 wall bracket and JSM 50H bracket for Eden

Accessories

Description	Type	Order code
Brackets and bottom plates		
JSM 55 Wall bracket for three position device	JSM 55	2TLA040005R0500
JSM 5B Wall bracket for 2 pcs MKey5 interlock switches	JSM 5B	2TLA040005R0700
JSM 54A Wall bracket for Adam. Used with AL bottom part that has a holder for Eva	JSM 54A	2TLA020205R2800
JSM 50G Bracket for key switches	JSM 50G	2TLA020205R6300
JSM 50H Bracket for Eden sensor	JSM 50H	2TLA020205R6400
Others		
JSHD4 protection coat	JSHD4 Coat	2TLA020200R4600

5

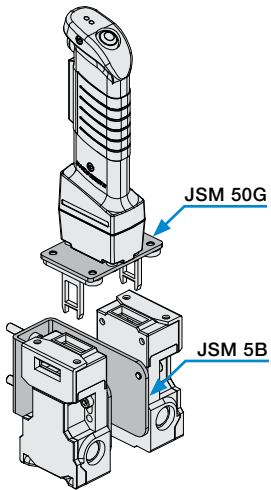

JSM 50G bracket for key switches and JSM 5B wall bracket for 2 pcs MKey5

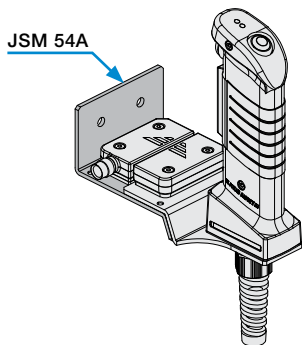

JSM 54A wall bracket for Adam (and AL bottom part that has a holder for Eva)



JSHD4 protection coat

Electrical wiring diagrams

Examples with JSHD4-1 and JSHD4-2 models

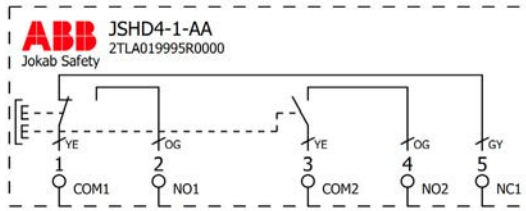

JSHD4-1-AA, cable gland and 5 screw connections on JSHD4-1

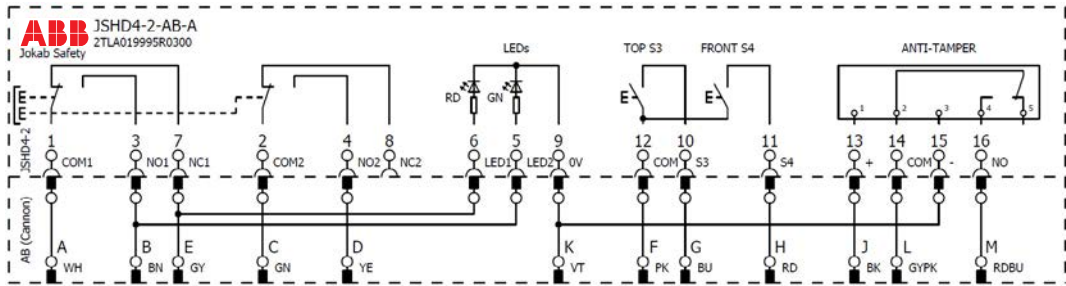
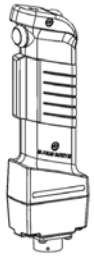

JSHD4-2-AB-A, Cannon 12 pins

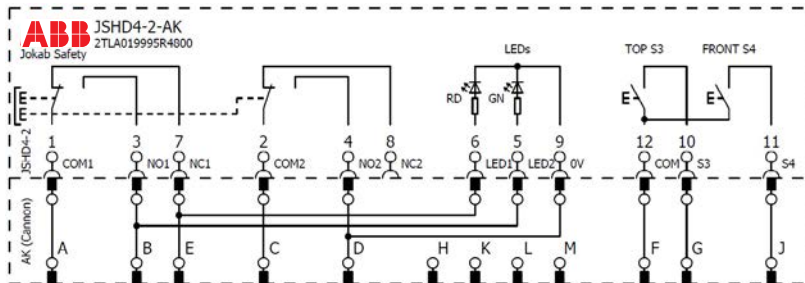
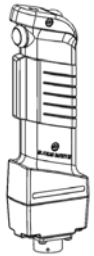

JSHD4-2-AK, Cannon 12 pins

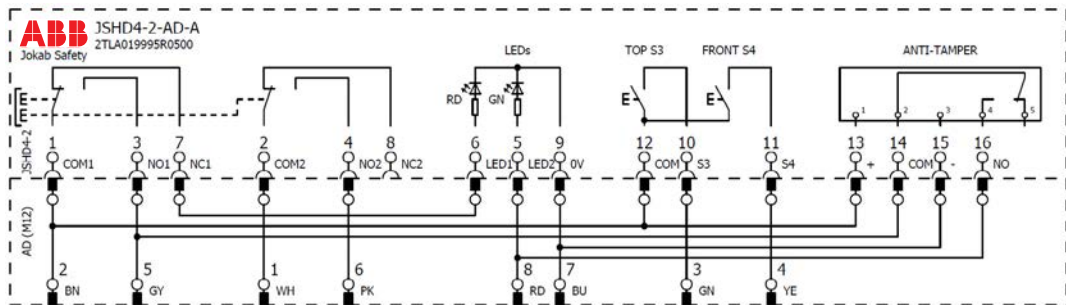
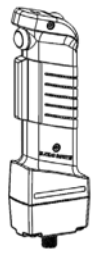

JSHD4-2-AD-A, M12-8

Electrical wiring diagrams

Examples with JSHD4-2 models

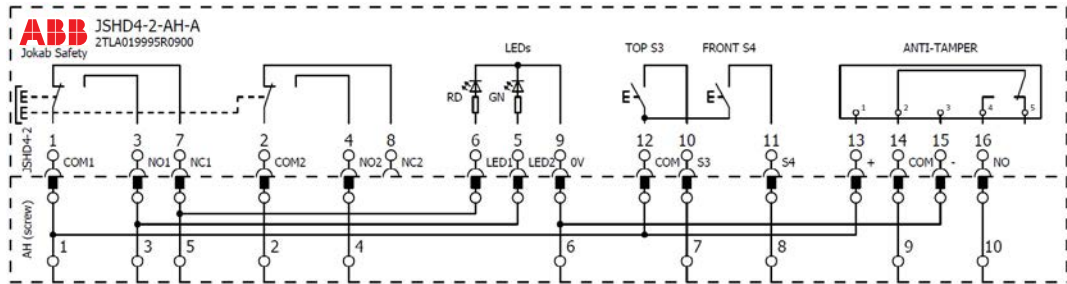

JSHD4-2-AH-A, cable gland and 10 screw connection

5

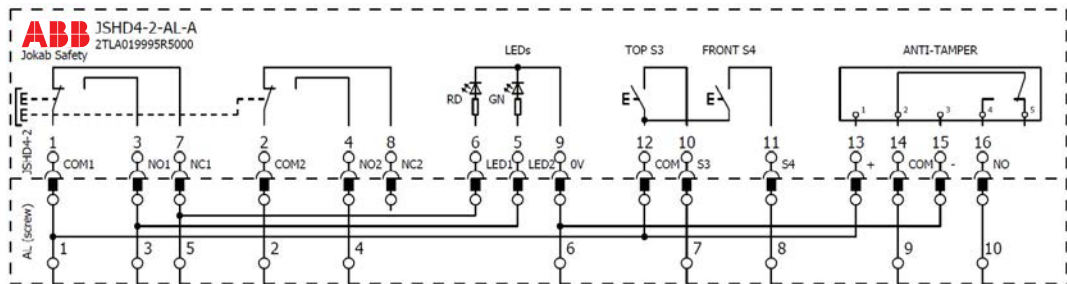
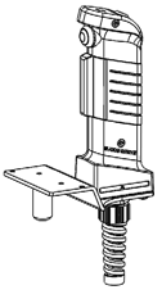

JSHD4-2-AL-A, cable gland and 10 screw connection

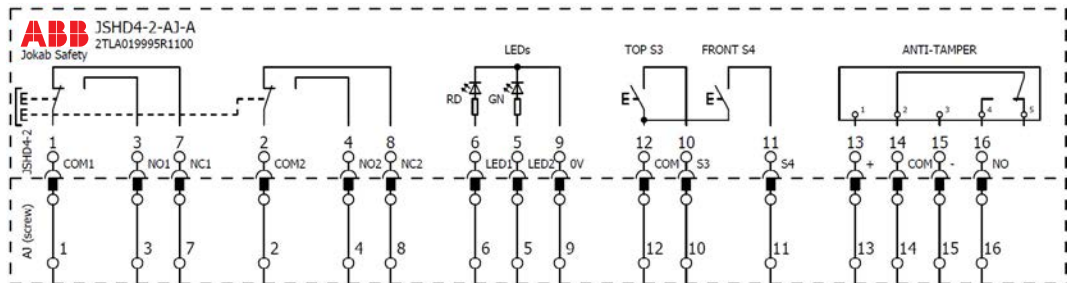



JSHD4-2-AJ-A, cable gland and 16 screw connection

Technical data and dimension drawings

JSHD4

Technical data

Approvals	Inspecta  
Conformity	CE 2006/42/EC - Machinery EN ISO 12100:2010, EN 60204-1:2007+A1:2009, EN ISO 13849-1:2016
Functional safety data	Up to PL e (depending on number of operations per year) B _{10g} : 2 000 000 to middle position, 968 000 to bottom position
Electrical data	
Current allowed, three-position button	Per channel: Maximum +30 VDC, 20 mA, (Minimum +10 VDC, 8 mA)
Current allowed, extra button	Maximum 500 mA
Operation force	Approx. 15 N for three-position buttons (ON) Approx. 45 N for three-position buttons (OFF) Approx. 2.5 N for top/front push button
Mechanical data	
Operating temperature	- 10 ... +50 °C
Protection class	IP65
Mechanical life	1 000 000 cycles to middle position
Weight	Approx. 0.2 kg without cable

5

More information

For more information, e.g. the complete technical information, see product manual for: JSHD4 [2TLC172072M0201](#)

Dimension drawings

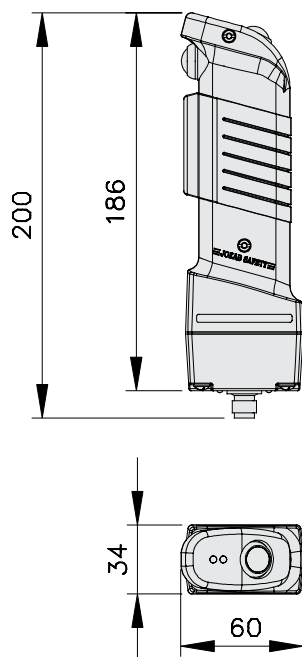

JSHD4-2-AD

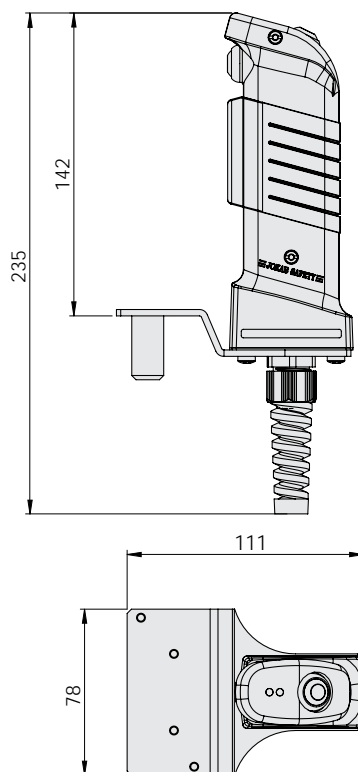

JSHD4-2-AL

All dimensions in mm



Emergency stops and pilot devices

Introduction and overview



Selection guide	6/2
Emergency stop buttons – Smile, INCA, EStrong and Compact	6/6
Safety stop buttons – Smile, INCA and Compact	6/14
Pull wire emergency stop switch – LineStrong	6/22
Push-button box – Smile 41	6/32
Reset button – Smile	6/38

Introduction and overview

Selection guide

ABB offers a full range of buttons and pull wires for emergency stop functions, as well as pilot devices for e.g. reset functions.

	Emergency stop buttons	Safety stop buttons
Type	Smile, Inca, EStrong, Compact	Smile, Inca, Compact
Image		
Description	Emergency stop buttons for external mounting and panel mounting in different sizes and material.	Safety stop buttons for external mounting and panel mounting
Applications	Safely stop dangerous machine functions	Safely stop a limited part of a dangerous machine
Advantages	Models with: <ul style="list-style-type: none"> - Compact size - Robust enclosure for harsh environments - Quick installation with M12 connectors - LED indication 	Models with: <ul style="list-style-type: none"> - Compact size - Robust enclosure for harsh environments - Quick installation with M12 connectors - LED indication

	Pull wire emergency stop switches	Push button boxes	Reset buttons
Type	LineStrong	Smile 41	Smile
Image			
Description	Emergency stop switches in robust enclosures for pull wires of various lengths.	Gathers up to four push buttons, including emergency stop, in a single compact device	Small and easy to install reset button
Applications	Emergency stop line to safely stop conveyor belts and long transportation lines.	Emergency stop and pushbuttons in one device	Pushbutton for resetting safety devices
Advantages	<ul style="list-style-type: none"> - Up to 200 m wire with one switch - Reliable mechanical connection - Robust construction 	<ul style="list-style-type: none"> - Compact size - Quick installation - M12 connector - LED indication - Highly adaptable with several button colors 	<ul style="list-style-type: none"> - Compact size - Quick installation - M12 connector - LED indication

Introduction and overview

Selection orientation

Why an emergency stop is necessary

If a machine breaks down or if someone is in danger, anyone should be able to stop the machine, regardless of their knowledge of the specific application.



When a safety stop could be used

A safety stop (also called machine stop) should be used to safely stop a part of the machine, e.g. as a stop for an individual hazardous motion. It should not be used as an emergency stop and stop the complete machine. Likewise, an emergency stop with red push button must not be used as a safety stop.



6

In order to separate the safety stop function from the emergency stop function, the safety stop buttons should be colored black.

When a pull wire emergency stop could be used

A pull wire emergency stop is easier to install than a system of several emergency stop buttons along a carriage path which makes it ideal for installations over long distances. LineStrong can handle wires up to 200 m on one single switch and the emergency command can be initiated from any point along the installed wire length.



Emergency stop buttons

Smile, INCA, EStrong and Compact

Emergency stop buttons are used to safely stop dangerous machine functions.

ABB offers a wide range of emergency stop buttons for external mounting or panel mounting, with plastic or metal housing and for different types of connections.



6



Easy to install

Compact size

Models with a compact and appealing housing saves space and makes it easy to place.

Quick installation

Quick and easy installation of models with features such as centered mounting holes, removable terminal blocks and M12 connectors.

Serial connection

Tina models save cable length and installation time with serial connection.



Optimum interface

Highly adaptable

Several models to choose between depending on position, installation and function.

Reliable in extreme conditions

Robust models and models in stainless steel for use in demanding environments.



Continuous operation

LED diagnostics

Models with integrated LED diagnostics reduce downtime when troubleshooting.

Models and application

Emergency stop buttons

Models for external mounting

Smile

Smile is a small and easy to install emergency stop button. Its size allows mounting in reduced spaces, and its centered mounting holes makes it especially easy to mount on aluminum extrusions (e.g. Quick-Guard fencing system). Smile is available with M12 connectors or cable.

Smile has an integrated LED in the button that shows the status and simplifies error tracking.

The standard models of Smile have 2 contacts and can be used with safety controllers from all brands. Smile Tina models belong to the ABB DYNlink solution, with the advantages of serial connection using only one channel and still reaching Cat. 4/PL e.



Compact

Compact emergency stop buttons offer a robust enclosure with a high IP rating that fulfill the demands in severe and humid environments, such as food and beverage industry. Compact can be fitted with a Tina adapter for use in a DYNlink solution (Tina 2A, Tina 2B or Tina 3A).



EStrong

EStrong is an emergency stop button designed to provide a robust unit in exposed and severe environments. The unit has a stainless steel enclosure with IP69K rating that withstands high pressure and high temperature wash-down. It is therefore ideally suited for industries with special demands, such as food processing or chemical industry.



Models for panel mounting

INCA

INCA is an emergency stop button for panel mounting, designed for installation in 22.5 mm holes. Its removable terminal block facilitates connection and exchange.

INCA has an integrated LED in the button that shows the status and simplifies error tracking.

The standard model of INCA has 2 contacts and can be used with safety controllers from all brands. INCA Tina models belong to the ABB DYNlink solution, with the advantages of serial connection using only one channel and still reaching Cat. 4/PL e.



Smile Reverse

Smile Reverse is identical to the regular Smile emergency stop button besides from being reversed in order to be mounted on the back side of a panel. Smile Reverse has an IP65 housing that makes it suitable in panels where moisture and dust may occur.

Smile Reverse has an integrated LED in the button that shows the status and simplifies error tracking.

The standard model of Smile Reverse has 2 contacts and can be used with safety controllers from all brands. The Smile Reverse Tina model belongs to the ABB DYNlink solution, with the advantages of serial connection using only one channel and still reaching Cat. 4/PL e.



Application

Emergency stop buttons are used to safely stop a dangerous machine function in order to prevent an accident, or minimize the consequences of an accident. An emergency stop should be a complement to other safety devices, and not a replacement for them.



Features

Emergency stop buttons

Communication features

DYNlink

Emergency stop buttons with Tina in their name belong to the DYNlink solution, which enables serial connection using only one channel and still reaching Cat. 4/PL e. DYNlink devices must be used with Vital safety controller or Pluto programmable safety controller. Up to 30 DYNlink devices can be connected in series to Vital and up to 10 can be connected to each input on Pluto.

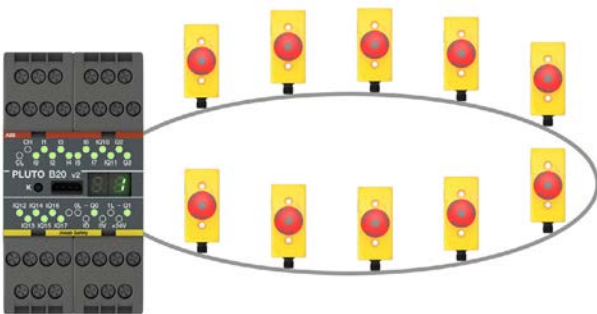

StatusBus

StatusBus is a simple and cost effective way to collect the status information of emergency stops and safety sensors. The StatusBus functionality is available with some DYNlink devices and allows to collect the status of each individual safety device, even when connected in series. A Pluto programmable safety controller must be used to read the StatusBus information, and a single input on Pluto can collect the status of up to 30 safety devices. The devices are connected using standard cable and M12-5 connectors. No specific bus cable or extra communication module is necessary.

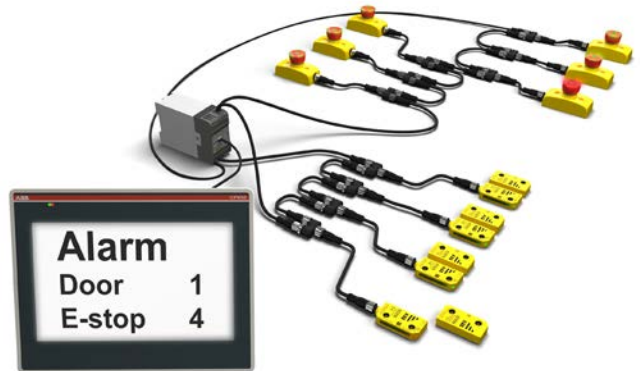

AS-i

Smile is available in a model compatible with the AS-i safety bus. Smile AS-i can be used with any AS-i monitor. AS-i is a bus system that offers a very simple connection of up to 31 safety devices to one monitor according to PL e and makes it easy to move, remove and add safety devices. When Smile AS-i is used with Pluto programmable safety controller, no other AS-i master or monitor is necessary, and no specific knowledge of AS-i is required.



Ordering information

Emergency stop buttons



Smile 10 EA Tina

2TLC172868F0201



Smile 11 EC Tina

2TLC172857F0201



Smile 12 EA

2TLC172187F0201



ABB Compact emergency stop shroud



EStrongZ and EStrongZ LED

2TLC172868F0201



Smile 11 EAR

2TLC172868F0201



INCA 1

2TLC172863F0201

External mounting

Description	Type of safety signal	Connection type	Feature	Type	Order code
Compact size Plastic housing IP65	DYNlink	1 m cable from bottom	Status LED	Smile 10 EA Tina	2TLA030050R0400
		1 x M12-5 male	Status LED	Smile 11 EA Tina	2TLA030050R0000
		1 x M12-5 male	Status LED, StatusBus	Smile 11 EC Tina	2TLA030050R0900
	AS-i	2 x M12-5 male	Status LED	Smile 12 EA Tina	2TLA030050R0200
		1 x M12-4 male	Status LED	Smile 11 EA AS-i	2TLA030052R0000
		2 NC	1 m cable from bottom	Status LED	Smile 10 EA
Plastic housing IP66, IP67 and IP69K	2 NC*	1 m leads from bottom	-	Smile 10 EK	2TLA030051R0600
		1 x M12-5 male	Status LED	Smile 11 EA	2TLA030051R0000
		2 x M12-5 male	Status LED	Smile 12 EA	2TLA030051R0200
Metal housing IP67 and IP69K	2 NO + 2 NC	3 x M20 conduits	Status LED	EStrongZ LED	2TLA050220R0222
			-	EStrongZ	2TLA050220R0020

* Can be adapted to DYNlink with Tina

Panel mounting

IP rating	Depth	Connection type	Type of safety signal	Feature	Type	Order code
IP65	26 mm	1 x M12-5 male	DYNlink	Status LED	Smile 11 EAR Tina	2TLA030050R0100
			2 NC	Status LED	Smile 11 EAR	2TLA030051R0100
Button IP65, connector IP20	53 mm	Removable terminal block	DYNlink	Status LED	INCA 1 Tina	2TLA030054R0000
				Status LED, StatusBus	INCA 1 EC Tina	2TLA030054R1400
			2 NC	Status LED	INCA 1	2TLA030054R0100

Accessories

Emergency stop buttons



M12-3S

2TLC172034V0201



Tina 8A

2TLC172471F0201



E-sign 22.5

2TLC172906F0201

Connection accessories

Description	Type	Order code
Connection accessories		
M12 Y-connector for serial connection of device with StatusBus functionality.	M12-3S	2TLA020055R0600
M12 Y-connector for serial connection of devices without StatusBus functionality.	M12-3A	2TLA020055R0000
Connection block for the serial connection of up to 4 DYNlink devices with 12-5 connectors.	Tina 4A	2TLA020054R0300
Connection block for the serial connection of up to 8 DYNlink devices with 12-5 connectors.	Tina 8A	2TLA020054R0500
Adaptation unit for DYNlink solution with M20 fitting. For e.g. Compact.	Tina 2A*	2TLA020054R0100
Adaptation unit for DYNlink solution, internal assembly. For e.g. Compact.	Tina 2B*	2TLA020054R1100
Adaptation unit for DYNlink solution with M20 fitting and M12 connector. For e.g. connecting Compact to Pluto/Vital.	Tina 3A*	2TLA020054R0200
Termination for Smile 12	JST2	2TLA030051R1300

Accessories

Emergency stop sign, yellow, no text, for INCA (22.5mm)	E-Sign 22.5	2TLA030054R0900
Emergency stop sign, yellow, no text, for Smile (32.5mm)	E-Sign 32.5	2TLA030054R1000
Yellow surround for Inca	Surround for Inca	2TLA030054R0400
Yellow shroud for Compact	CA1-8053	1SFA619920R8053
Stainless steel cable gland, for EStrong	Gland M20x1.5	2TLA050040R0002
Stainless steel conduit plug, for EStrong	Conduit Plug M20x1.5	2TLA050040R0004
LED Green/Red 230 VAC, for EStrong	LED 230	2TLA050211R0003

* For more information about Tina adapter units, please see Pluto and Vital chapters.

Cable with connectors

Connector	Female/male	Length	Special feature	Type	Order code
M12-5	Female	6 m		M12-C61	2TLA020056R0000
			Harsh environment, halogen free	M12-C61HE	2TLA020056R8000
		10 m		M12-C101	2TLA020056R1000
			Harsh environment, halogen free	M12-C101HE	2TLA020056R8100
		20 m		M12-C201	2TLA020056R1400
				M12-C0312	2TLA020056R5800
	Female + male	0.3 m		M12-C00612	2TLA020056R6300
		0.06 m		M12-C112	2TLA020056R2000
		1 m		M12-C312	2TLA020056R2100
		3 m		M12-C612	2TLA020056R2200
		6 m		M12-C1012	2TLA020056R2300
		10 m	Angled female connector	M12-C1012V2	2TLA020056R6700
	16 m		M12-C1612	2TLA020056R5400	
	20 m		M12-C2012	2TLA020056R2400	



M12-C61

2TLC172951F0201



M12-C61HE

2TLC010003F0201



M12-C01

2TLC172657R0201



C5 cable

2TLC010039F0201

Separate cables and connectors

Description	Type	Order code
Connectors		
M12-5 pole female, straight	M12-C01	2TLA020055R1000
M12-5 pole male, straight	M12-C02	2TLA020055R1100









Cable with 5 conductors

10 m cable with 5 x 0.34 shielded conductors	C5 cable 10 m	2TLA020057R0001
50 m cable with 5 x 0.34 shielded conductors	C5 cable 50 m	2TLA020057R0005
100 m cable with 5 x 0.34 shielded conductors	C5 cable 100 m	2TLA020057R0010
200 m cable with 5 x 0.34 shielded conductors	C5 cable 200 m	2TLA020057R0020
500 m cable with 5 x 0.34 shielded conductors	C5 cable 500 m	2TLA020057R0050

Technical data

Emergency stop buttons

Technical data

Approvals	
Smile, INCA	
Smile Tina, INCA Tina	TÜV NORD 
Smile AS-i	TÜV NORD 
EStrong	 
Compact	   
Conformity	
Smile, INCA	CE 2006/42/EC - Machinery EN ISO 12100:2010, EN ISO 13849-1:2008/AC:2009, EN 60204-1:2006+A1:2008, EN ISO 13850:2008
Smile Tina, INCA Tina	CE 2006/42/EC - Machinery 2004/108/EC - EMC EN ISO 12100:2010, EN ISO 13849-1:2008, EN 62061:2005, EN 60204-1:2006+A1:2009, IEC 60664-1:2007, EN 61000-6-2:2005, EN 61000-6-4:2007, EN 60947-5-5:2005, EN ISO 13850:2006
Smile AS-i	CE 2006/42/EC - Machinery EN ISO 12100:2010, EN ISO 13849-1:2008/AC:2009, EN ISO 13849-2:2012, EN 60204-1:2007+A1, EN ISO 13850:2008, IEC 60947-5-5:2005
EStrong	CE 2006/42/EC - Machinery EN ISO 12100:2010, EN ISO 13850:2008, EN 60204-1:2006+A1:2009, EN 60947-1:2007+A1:2011, EN 60947-5-1:2004+A1:2009, EN 60947-5-5:1997+A1:2005
Compact	CE 2006/42/EC - Machinery EN 60947-1:2007, EN 60947-5-1:2004, EN 60947-5-5:1997+A1:2005
Functional safety data	
EN 61508:2010	Up to SIL3, depending on system architecture
EN 62061:2005	Up to SILCL3, depending on system architecture
EN ISO 13849-1:2008	Up to Cat. 4, PL e, depending on system architecture
Smile, INCA	$B10_d = 100\ 000$
Smile Tina, INCA Tina	$PFH_D = 4,66 \times 10^{-9}$
Smile AS-i	$PFH_D = 1,69 \times 10^{-9}$
EStrong	$B10_d = 1\ 500\ 000$
Compact	$B10_d = 50\ 000$

Technical data

Emergency stop buttons

Technical data

Electrical data	
Operating voltage	
Smile, INCA	17-27 VDC ± 10%
Smile Tina, INCA Tina	+24 VDC +15% -25%
Smile AS-i	+30 VDC from the AS-i bus. Tolerances 26.5 - 31.6 VDC
EStrong	230 VAC / +24 VDC (the LED is +24 VDC originally, but can be replaced with a 230 VAC accessory)
Compact	230 VAC / +24 VDC
Mechanical data	
Mechanical life	>50 000 operations
Operating temperature	
Smile, INCA	-10...+55 °C
EStrong	-25...+80 °C
Compact	-25...+70 °C
Protection class	
Smile, INCA	IP65
EStrong	IP67, IP69K
Compact	IP66, IP67, IP69K
Weight	
Smile	65 g
INCA	45 g
EStrong	820 g
Compact	108 g, 124 g (with shroud)
Material	
Smile	Polyamide PA66, Macromelt, polybutylenterephthalate PBT, Polypropene PP, UL 94 V0
INCA	Polyamide PA66, Macromelt, polybutylenterephthalate PBT, Polypropene PP, UL 94 V0
EStrong	Stainless steel 316 housing
Compact	Polycarbonate

6

More information

For more information, e.g. the complete technical information, see product manual for:

Smile [2TLC172097M0201](#)

INCA [2TLC172163M0201](#)

EStrong [2TLC172247M0201](#)

Compact [1SFC151005C0201](#)

Dimension drawings Emergency stop buttons

Smile

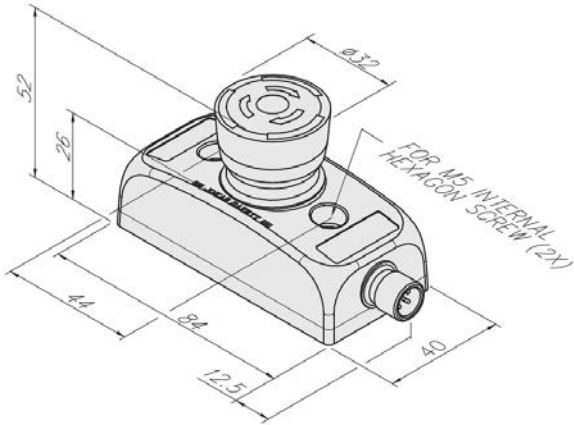

INCA

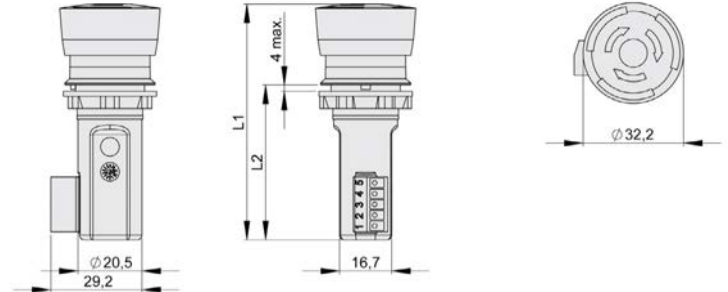

Type	L1 mm	L2 mm
INCA 1 EC Tina	75.5	49.5 ± 0.5
INCA 1	80	54 ± 0.5
INCA 1 Tina	80	54 ± 0.5

EStrong

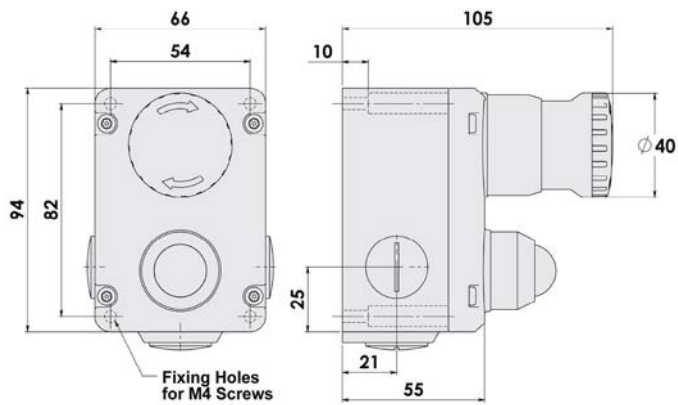

Compact

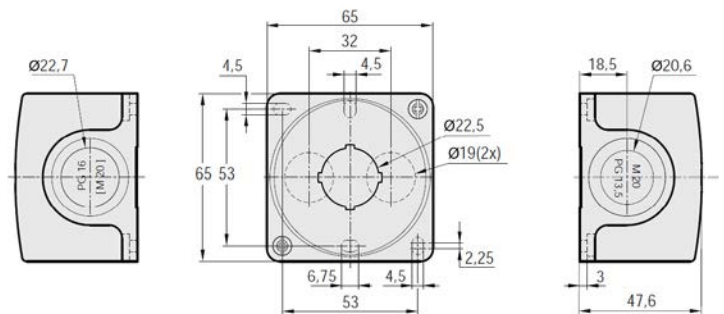

All dimensions in mm

Safety stop buttons

Smile, INCA and Compact

Safety stop buttons are used to safely stop a certain part of a dangerous machine.

ABB offers safety stop buttons to suit different needs of connection and communication. Models are available for e.g. external mounting or panel mounting, in compact size or robust design, adapted for the DYNlink solution or with 2 NC contacts.



6



Easy to install

Compact size

Models with a compact and appealing housing saves space and makes it easy to place.

Quick installation

Quick and easy installation of models with features such as centered mounting holes, removable terminal blocks and M12 connectors.

Serial connection

Tina models save cable length and installation time with serial connection.

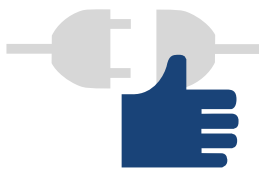

Optimum interface

Highly adaptable

Several models to choose between depending on position, installation and function.

Reliable in extreme conditions

Robust models for use in demanding environments.



Continuous operation

LED diagnostics

Models with integrated LED diagnostics reduce downtime when troubleshooting.

Applications and features

Safety stop buttons

Applications

A safety stop (also called machine stop) can be used to safely stop a part of the machine, e.g. as a stop for an individual hazardous machine function. It may not be used as an emergency stop and stop the complete machine or production line. Likewise, an emergency stop with red push button should not be used as a safety stop. In order to separate the safety stop function from the emergency stop function, the safety stop buttons should be colored black.



Features

DYNlink

Safety stop buttons with Tina in their name belong to the DYNlink solution, which enables serial connection using only one channel and still reaching Cat. 4/PL e. DYNlink devices must be used with Vital safety controller or Pluto programmable safety controller. Up to 30 DYNlink devices can be connected in series to Vital and up to 10 can be connected to each input on Pluto.

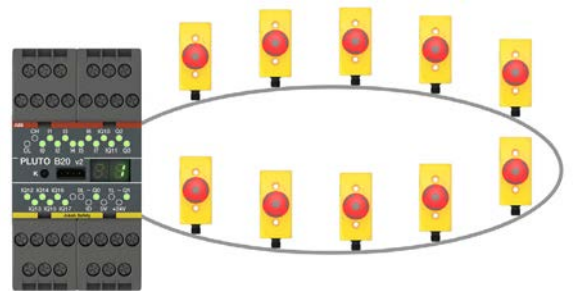

Models

Safety stop buttons

Safety stop buttons for external mounting

Smile

Smile is a small and easy to install safety stop button. Its size allows mounting in reduced spaces, and its centered mounting holes makes it especially easy to mount on aluminum extrusions (e.g. Quick-Guard fencing system).

Smile has an integrated LED in the button that shows the status and simplifies error tracking.

The standard model of Smile has 2 contacts and can be used with safety controllers from all brands. The Smile Tina model belongs to the ABB DYNlink solution, with the advantages of serial connection using only one channel and still reaching Cat. 4/PL e.

Smile safety stops are identical to the corresponding Smile emergency stops apart from the color of the button.



Compact

The Compact safety stop button offers a robust enclosure with a high IP rating that fulfills the demands in severe and humid environments, such as food and beverage industry. Compact can be fitted with a Tina adapter for use in a DYNlink solution (Tina 2A, Tina 2B or Tina 3A).

Compact safety stop is identical to Compact emergency stop apart from the color of the button.



Safety stops for panel mounting

INCA

INCA is a safety stop button for panel mounting, designed for installation in 22.5 mm holes. Its removable terminal block facilitates connection and exchange.

INCA has an integrated LED in the button that shows the status and simplifies error tracking.

The standard model of INCA has 2 contacts and can be used with safety controllers from all brands. INCA Tina belongs to the ABB DYNlink solution, with the advantages of serial connection using only one channel and still reaching Cat. 4/PL e.

INCA safety stop is identical to INCA emergency stop apart from the color of the button.



Ordering information

Safety stop buttons



Smile 11 SA Tina

2TLG172188R0201



CEP1-1002



INCA 1S

2TLG172385F0201



Tina 8A

2TLG172471R0201

Safety stop buttons

Mounting	Type of safety signal	Connection type	Feature	Type	Order code
External	DYNlink	1 m cable from bottom	Status LED	Smile 11 SA Tina	2TLA030050R0500
	2 NC	1 x M12-5	Status LED	Smile 11 SA	2TLA030051R0900
	2 NC*	2 x M20 conduits	-	CEP1-1002 (Compact)	1SFA619811R1002
			With shroud	CEP1-2002 (Compact)	1SFA619811R2002
Panel	DYNlink	5 pole terminal block	Status LED	INCA 1S Tina	2TLA030054R0200
	2 NC	5 pole terminal block	Status LED	INCA 1S	2TLA030054R0300

* Can be adapted to DYNlink with Tina

Accessories

Description	Type	Order code
M12 Y-connector for serial connection of devices without StatusBus functionality.	M12-3A	2TLA020055R0000
Connection block for the serial connection of up to 4 DYNlink devices with 12-5 connectors.	Tina 4A	2TLA020054R0300
Connection block for the serial connection of up to 8 DYNlink devices with 12-5 connectors.	Tina 8A	2TLA020054R0500
Grey shroud for Compact	CA1-8054	1SFA619920R8054
Adaptation unit for DYNlink solution with M20 fitting. For e.g. Compact.	Tina 2A *	2TLA020054R0100
Adaptation unit for DYNlink solution, internal assembly. For e.g. Compact.	Tina 2B *	2TLA020054R1100
Adaptation unit for DYNlink solution with M20 fitting and M12 connector. For e.g. connecting Compact to Pluto/Vital.	Tina 3A *	2TLA020054R0200

* For more information about Tina adapter units, please see Pluto and Vital chapters.

Cable and connectors

Safety stop buttons



M12-C61

2TLC172951F0201



M12-C61HE

2TLC010003F0201

Cable with connectors

Connector	Female/male	Length	Special feature	Type	Order code
M12-5	Female	6 m		M12-C61	2TLA020056R0000
			Harsh environment, halogen free	M12-C61HE	2TLA020056R8000
		10 m		M12-C101	2TLA020056R1000
			Harsh environment, halogen free	M12-C101HE	2TLA020056R8100
	Female + male	0.3 m		M12-C201	2TLA020056R1400
				M12-C0312	2TLA020056R5800
		0.06 m		M12-C00612	2TLA020056R6300
				M12-C112	2TLA020056R2000
		1 m		M12-C312	2TLA020056R2100
				M12-C612	2TLA020056R2200
10 m			M12-C1012	2TLA020056R2300	
		Angled female connector	M12-C1012V2	2TLA020056R6700	
			M12-C1612	2TLA020056R5400	
			M12-C2012	2TLA020056R2400	

6

Separate cables and connectors

Description	Type	Order code
Connectors		
M12-5 pole female, straight	M12-C01	2TLA020055R1000
M12-5 pole male, straight	M12-C02	2TLA020055R1100
Cable with 5 conductors		
10 m cable with 5 x 0.34 shielded conductors	C5 cable 10 m	2TLA020057R0001
50 m cable with 5 x 0.34 shielded conductors	C5 cable 50 m	2TLA020057R0005
100 m cable with 5 x 0.34 shielded conductors	C5 cable 100 m	2TLA020057R0010
200 m cable with 5 x 0.34 shielded conductors	C5 cable 200 m	2TLA020057R0020
500 m cable with 5 x 0.34 shielded conductors	C5 cable 500 m	2TLA020057R0050



M12-C01

2TLC172655F0201







C5 cable

2TLC010003F0201

Technical data

Safety stop buttons

Technical data

Approvals	
Smile, INCA	
Smile Tina, INCA Tina	TÜV NORD 
Compact	  
Conformity	
Smile, INCA	CE 2006/42/EC - Machinery EN ISO 12100:2010, EN ISO 13849-1:2008/AC:2009, EN 60204-1:2006+A1:2008, EN ISO 13850:2008
Smile Tina, INCA Tina	CE 2006/42/EC - Machinery 2004/108/EC - EMC EN ISO 12100:2010, EN ISO 13849-1:2008, EN 62061:2005, EN 60204-1:2006+A1:2009, IEC 60664-1:2007, EN 61000-6-2:2005, EN 61000-6-4:2007, EN 60947-5-5:2005, EN ISO 13850:2006
Compact	CE 2006/42/EC - Machinery EN 60947-1:2007, EN 60947-5-1:2004, EN 60947-5-5:1997+A1:2005
Functional safety data	
EN 61508:2010	Up to SIL3, depending on system architecture
EN 62061:2005	Up to SILCL3, depending on system architecture
EN ISO 13849-1:2008	Up to Cat. 4, PL e, depending on system architecture
Smile, INCA	$B10_d = 100\ 000$
Smile Tina, INCA Tina	$PFH_D = 4.66 \times 10^{-9}$
Compact	$B10_d = 50\ 000$
Electrical data	
Operating voltage	
Smile, INCA	17-27 VDC \pm 10%
Smile Tina, INCA Tina	+24 VDC +15% -25%
Compact	230 VAC / +24 VDC
Mechanical data	
Mechanical life	>50 000 operations
Operating temperature	
Smile, INCA	-10...+55 °C
Compact	-25...+70 °C
Protection class	
Smile, INCA	IP65
Compact	IP66, IP67, IP69K
Weight	
Smile	65 g
INCA	45 g
Compact	108 g, 124 g (with shroud)
Material	
Smile	Polyamide PA66, Macromelt, polybutylenterephthalate PBT, Polypropene PP, UL 94 V0
INCA	Polyamide PA66, Macromelt, polybutylenterephthalate PBT, Polypropene PP, UL 94 V0
Compact	Polycarbonate

More information

For more information, e.g. the complete technical information, see product manual for:

Smile [2TLC172097M0201](#)

INCA [2TLC172163M0201](#)

Compact [1SFC151005C0201](#)

Dimension drawings Safety stop buttons

Smile

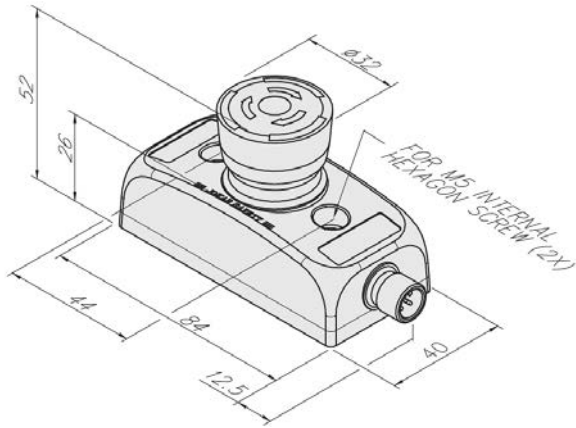

INCA

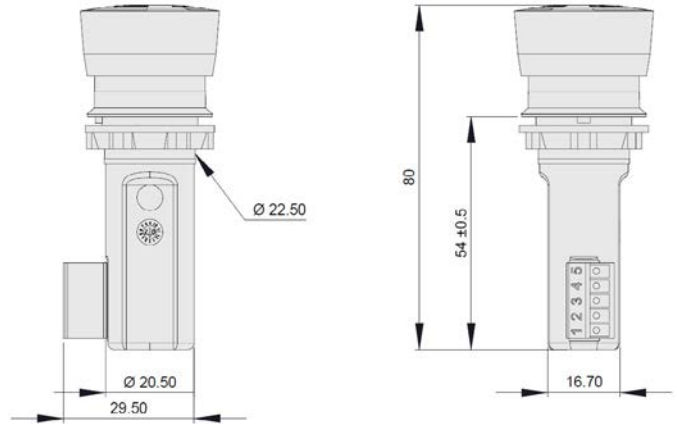

6

Compact

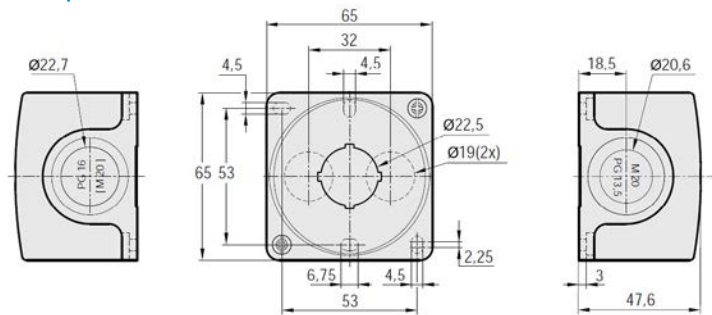

All dimensions in mm

Pull wire emergency stop switch LineStrong

LineStrong is a pull wire emergency stop switch, used for easy reach of the emergency stop function along machines and sections of conveyors.

A pull wire emergency stop switch allows to initiate the emergency stop command from any point along the installed wire length by pulling the wire. It replaces a series of emergency stop buttons and is easier to install.

LineStrong is also available in different models for different lengths of wires, with different housing material as well as an explosion proof version.



6



Easy to install

Quick installation

A pull wire emergency stop switch is easier to install than a system of several emergency stop buttons along a carriage path.

Highly adaptable

Several models to choose between gives a variety of mounting possibilities and features.

Long wire length

Can handle wires up to 200 m on a single switch.



Safety and protection

Easily accessible

Easy reach of the emergency stop function along machines, conveyors and processes.

High level of safety

The positive forced disconnect contacts provide a high level of safety and are double switching, i.e. triggers emergency stop in both directions of the wire.



Continuous operation

Reliable in extreme conditions

Robust construction makes LineStrong ideal for use in demanding environments.

LED diagnostics

Integrated LED diagnostics ensures status can be seen easily from a distance.

Applications

LineStrong

Instead of multiple emergency stops

A pull wire emergency stop switch is often placed along conveyor belts or carriage paths where access to the stop function must be possible along the whole line. It is often easier to install a pull wire emergency stop switch than to place multiple emergency stop buttons if the distance is longer.

LineStrong can handle wires up to 200 m on one single switch and since the emergency stop command can be initiated from any point along the wire, this gives better access to the emergency stop function than using emergency stop buttons.

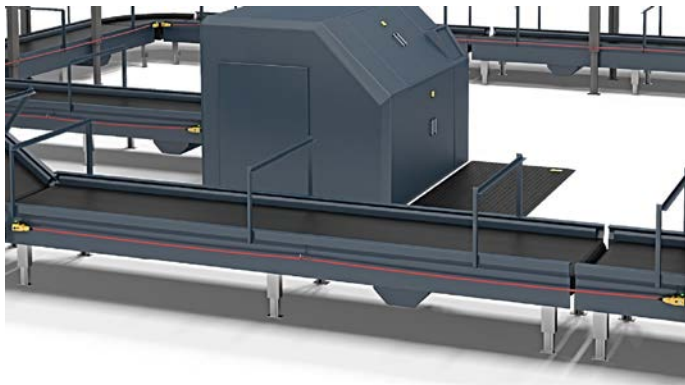

As protective device in low risk applications

LineStrong can be used as protection, for example along conveyors with low risks where the wire can be installed at waist height in front of the conveyor, which provides an emergency stop if someone walks or falls towards the conveyor, hence pulling the wire.

One, two or several switches

The maximum length of the wire attached to LineStrong depends on if there is a LineStrong unit attached to both ends of the wire or if one end is attached to a wall/fixed object. In the image below LineStrong2 is used as an example.

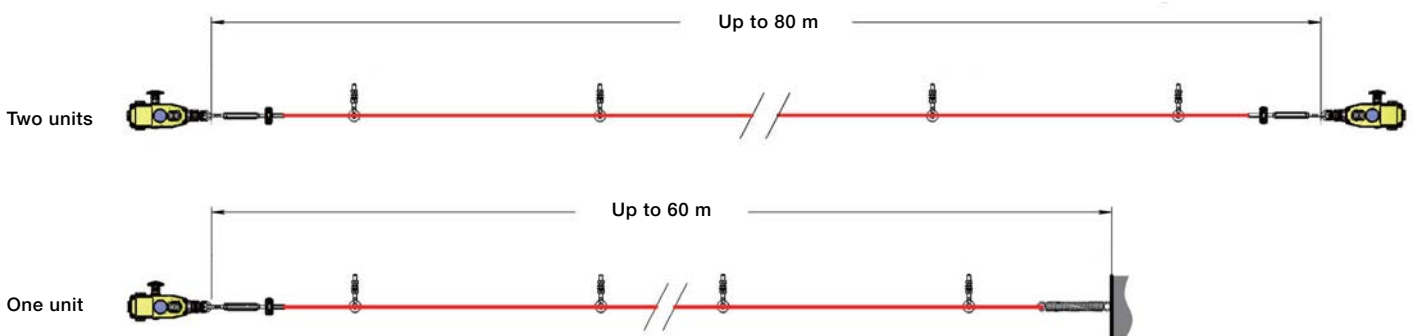

Features

LineStrong

Positive forced disconnected contacts

The contacts in LineStrong are positive force disconnected, which ensures that the contacts will not be held in a normally closed position due to a failure of the spring mechanism or the welding/sticking of the contacts.

Reset button

All models of LineStrong have an integrated reset button that needs to be pressed in order to reset the emergency stop if the emergency stop function has been triggered.

Emergency stop button

Most LineStrong models have an integrated emergency stop button on the housing of the switch. Since the first half meter of the wire is not intended to pull in order to trigger the emergency stop function, the integrated emergency stop button provides quick and simple access to the emergency stop function if you are standing right in front of LineStrong. The emergency stop button of LineStrong 2 can be moved to either side of LineStrong to enable best access depending on position and height of LineStrong.

Integrated LED

LineStrong2 and LineStrong3 have an integrated 2-color LED that shows if the emergency stop function has been triggered or not. The LED is also available as spare part.

Material

LineStrong is available with a housing in yellow die cast aluminum alloy or with a housing in stainless steel 316 which is recommended for severe applications in e.g. the food processing and the chemical industries.

Left hand, right hand or both sides

LineStrong1 and LineStrong2 can be mounted in any direction. LineStrong3 is available in different models depending on installation. L (left hand) should be used if the placement of the grab wire switch is to the left in the installation. R (right hand) should be used if the grab wire switch is to the right in the installation. D (double wire) has wire entries from both sides of the grab wire switch.

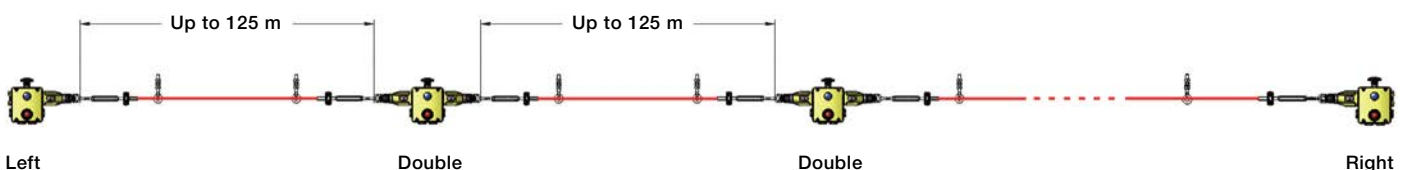

Wire breakage monitoring

The contacts are double switching which means that the emergency stop command is given both when someone pulls the wire and if the wire should break.

Indication of wire tension

All models are equipped with an indicator of the tension of the wire which simplifies installation and adjustment.

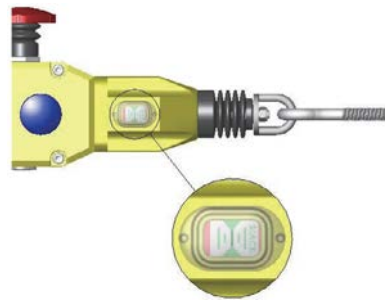

Explosion proof

LineStrong2 also exists in an X-model with certified explosion proof contact blocks. The X-model has a stainless steel body and can be used in ATEX zones 1, 2, 21 and 22 (gas and dust). The X-model is preassembled with a 3 m cable.

Features

LineStrong

Easier installation with tensioner/gripper

The tensioner/gripper accessory significantly reduces the installation time. Traditional grab wire systems normally need turnbuckle and clamps, which are difficult to tension and adjust, and normally require frequent re-tensioning. The tensioner gripper integrates an eyehook, a tensioner thimble and a wire strength gripper in one assembly which enables rapid connection to the switch eyebolts and fast and accurate tensioning of the wire.

Thanks to the switch tension indicator, it is easy to adjust the system accurately and quickly. The double clamp mechanism prevents wire slippage and significantly reduces machine down-time which can occur with traditional turnbuckle systems.

For systems longer than 50 m, the tensioner/gripper is necessary on both sides.

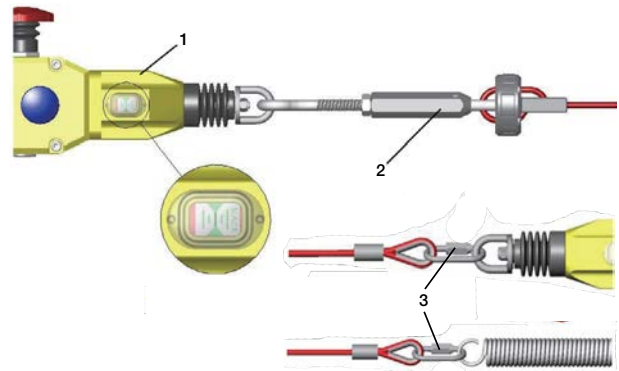

1. Tension to mid position as indicated by the green arrows in the viewing window of each switch
2. The tensioner thimble allows immediate accurate and final tensioning of the wire, whilst viewing the tension marker through the viewing window on the switch.
3. Quick Link termination.

Quick-link termination

The quick link termination is provided for easy connection to the safety spring or the switch eyebolt for systems up to 50 m.

Mounting accessories

The wire pull kits contain the suitable accessories for the included wire length.

- When using one switch, the wire must be anchored at the other end using a safety spring.
- The first eyebolt support must be placed no more than 500 mm from the switch eyebolt or safety spring.
- The part of the wire from the wire end to the first eyebolt support shall not be used as part of the active protection coverage.
- Wire support eyebolts must be fitted at 2.5 - 3 meters intervals along the complete wire length.
- The tensioner/gripper is used to adjust the correct tension

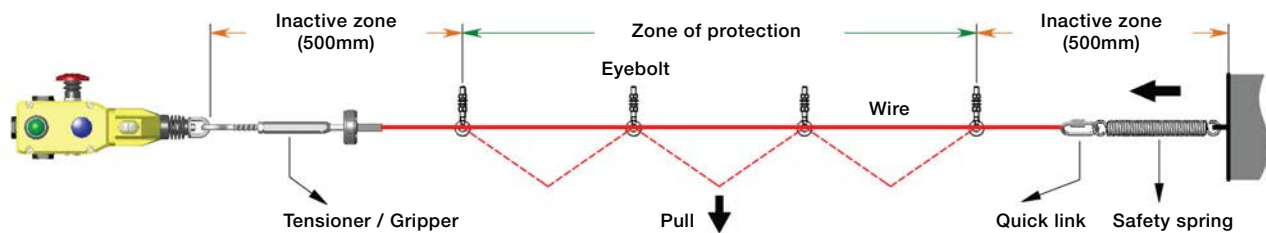

Corner pulley

A corner pulley can be used to navigate inside or outside corners without causing damage to the wire. They are in stainless steel and can be rigidly mounted.

When using a safety spring, a maximum of one corner pulley may be used, to ensure that the complete length of the wire is visible from either the switch or the spring anchorage.

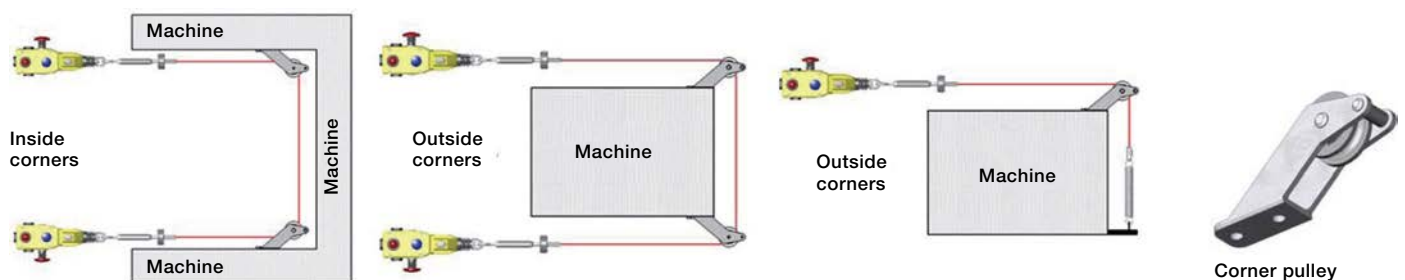

Examples of using the corner pulley

Ordering information

LineStrong



2TLC172377F0201

LineStrong1



2TLC172378F0201

LineStrong2



2TLC172501F0201

LineStrong2Z



2TLC172385F0201

LineStrong3L



2TLC172387F0201

LineStrong3R



2TLC172389F0201

LineStrong3D

LineStrong

IP rating	Material	E-stop button	Contacts	Max. wire length (m)		Feature	Type	Order code
				1 unit	2 units			
IP67	Yellow die cast aluminum alloy	No	2 NO + 2 NC	30	50	-	LineStrong1	2TLA050200R030
		Yes	2 NO + 2 NC	60	80	-	LineStrong2	2TLA050202R0332
			2 NO + 4 NC	100	125	Left hand	LineStrong3L	2TLA050206R0332
						Right hand	LineStrong3R	2TLA050208R0332
			200	325	Both sides	LineStrong3D	2TLA050204R0332	
LineStrong2Z	2TLA050202R0322							
IP67, IP69K	Stainless steel 316	Yes	2 NO + 2 NC	60	80	-	LineStrong2Z	2TLA050202R0322
				80	100	Explosion proof	LineStrong2ZX	2TLA050202R7125
			2 NO + 4 NC	100	125	Left hand	LineStrong3LZ	2TLA050204R0322
						Right hand	LineStrong3RZ	2TLA050206R0322
			200	325	Both sides	LineStrong3DZ	2TLA050208R0322	

Accessories LineStrong



Wire pull kit

2TLC172577F0201



Wire tensioner

2TLC1722220F0201



Corner pulley

2TLC172581F0201



Eyebolt

2TLC172219R0201



Safety spring

2TLC172221F0201



LineStrong Screwdriver

2TLC172215R0201



Gland

2TLC172217R0201



Conduit plug

2TLC172218R0201



LineStrong LED 230

2TLC172902F0201

Mounting accessories

Description	Material	Length	Type	Order code
Wire pull kit including wire, eyebolts, tensioner/gripper and Allen key in right quantity for the included wire length.	Galvanized	10 m wire	10 m wire kit, gal	2TLA050210R0130
		20 m wire	20 m wire kit, gal	2TLA050210R0330
		80 m wire	80 m wire kit, gal	2TLA050210R0630
		100 m wire	100 m wire kit, gal	2TLA050210R0730
	Stainless steel	50 m wire	50 m wire kit, SS	2TLA050210R0520
		100 m wire	100 m wire kit, SS	2TLA050210R0720
Wire tensioner/gripper	Galvanized		Wire tensioner, gal	2TLA050210R4030
	Stainless steel		Wire tensioner, SS	2TLA050210R4020
Corner pulley	Galvanized		Corner pulley, gal	2TLA050210R6030
	Stainless steel		Corner pulley, SS	2TLA050210R6020
Eyebolt M8 x 1.25	Galvanized		Eyebolt M8x1.25, gal	2TLA050210R8030
	Stainless steel		Eyebolt M8x1.25, SS	2TLA050210R8020
Safety spring, 220mm	Stainless steel		Spring 220 mm, SS	2TLA050211R0004

Other accessories

Description	Type	Order code
Screwdriver, anti-tamper, Torx T20	Screwdriver T20	2TLA050211R0006
Gland M20 x 1.5	Gland M20x1.5	2TLA050040R0002
Conduit plug M20 x 1.5	Cond.Plug M20x1.5	2TLA050040R0004

Spare parts

Description	Type	Order code
LineStrong LED Green/Red +24 VDC	LineStrong LED 24	2TLA050211R0001
LineStrong LED Green/Red 230 VAC	LineStrong LED 230	2TLA050211R0003
LineStrong2 and LineStrong3 Emergency stop button.	LineStrong E-Stop	2TLA050211R0005

Cables LineStrong



M12-C01

2TLC017265R0201



C5 cable

2TLC011033R0201

Separate cables and connectors

Description	Type	Order code
Connectors		
M12-5 pole female, straight	M12-C01	2TLA020055R1000
M12-5 pole male, straight	M12-C02	2TLA020055R1100
M12-8 pole female, straight	M12-C03	2TLA020055R1600
M12-8 pole male, straight	M12-C04	2TLA020055R1700
Cable with 5 conductors		
10 m cable with 5 x 0.34 shielded conductors	C5 cable 10 m	2TLA020057R0001
50 m cable with 5 x 0.34 shielded conductors	C5 cable 50 m	2TLA020057R0005
100 m cable with 5 x 0.34 shielded conductors	C5 cable 100 m	2TLA020057R0010
200 m cable with 5 x 0.34 shielded conductors	C5 cable 200 m	2TLA020057R0020
500 m cable with 5 x 0.34 shielded conductors	C5 cable 500 m	2TLA020057R0050
Cable with 8 conductors		
50 m cable with 8 x 0.34 shielded conductors	C8 cable 50 m	2TLA020057R1005
100 m cable with 8 x 0.34 shielded conductors	C8 cable 100 m	2TLA020057R1010
200 m cable with 8 x 0.34 shielded conductors	C8 cable 200 m	2TLA020057R1020
500 m cable with 8 x 0.34 shielded conductors	C8 cable 500 m	2TLA020057R1050

Technical data

LineStrong

Technical data

Approvals	
LineStrong	
LineStrong-X	
Conformity	
LineStrong	CE 2006/42/EC - Machinery EN ISO 12100:2010, EN ISO 13850:2008, EN 60204-1:2006+A1:2009, EN 60947-1:2007+A1:2011, EN 60947-5-1:2004+A1:2009, EN 60947-5-5:1997+A1:2005
LineStrong-X	CE /42/EC - Machinery 94/9/EC - ATEX EN ISO 12100:2010, EN ISO 13850:2008, EN 60204-1:2006+A1:2009, EN 60079-0:2011, EN 60079-1:2007, EN 60079-31:2008, EN 60947-1:2007+A1:2011, EN 60947-5-1:2004+A1:2009, EN 60947-5-5:1997+A1:2005
Functional safety data	
EN ISO 13849-1:2008	Up to Cat. 4, PL e, depending on system architecture.
EN/IEC 62061:2005	Up to SILCL3, depending on system architecture.
IEC 61508	Up to SIL3, depending on system architecture.
B10 _d	1 500 000
Electrical data	
	240 VAC / 3 A
Utilization category	+24 VDC / 2.5 A
LED	+24 VDC
Mechanical data	
Operating temperature	-25...+80 °C
Protection class	
LineStrong1, LineStrong2, LineStrong3	IP67
LineStrong2Z(X), LineStrong3Z	IP66, IP67, IP69K
Weight	
LineStrong1	675 g
LineStrong2	880 g
LineStrong2Z(X)	1635 g
LineStrong3L/R	1100 g
LineStrong3LZ/RZ	2000 g
LineStrong3D	1320 g
LineStrong3DZ	2200 g
Material	
LineStrong1, LineStrong2, LineStrong3D/L/R	Die cast painted yellow
LineStrong2Z(X), LineStrong3LZ/ RZ/DZ	Stainless steel 316
Wire type	PVC sheath steel wire 4.0 mm outside diameter
Conduit entries	
LineStrong1/2	3 x M20 x 1.5
LineStrong3	4 x M20 x 1.5

More information

For more information, e.g. the complete technical information, see product manual for:
LineStrong [2TLC172248M0201](#)

Dimension drawings LineStrong

LineStrong1

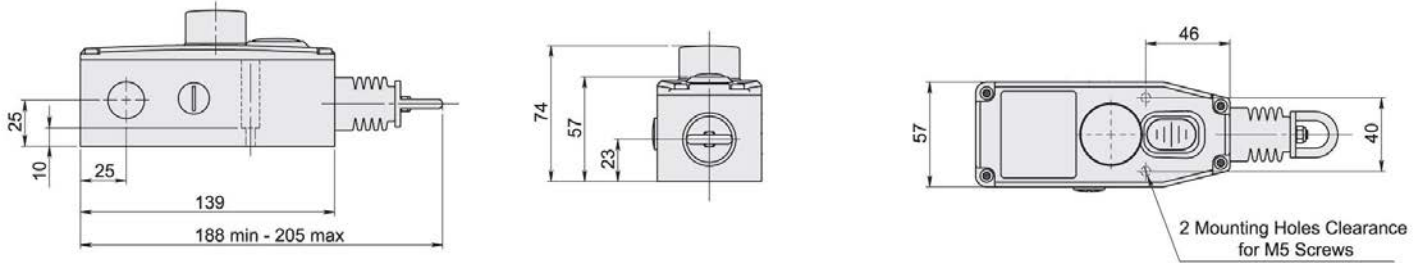

LineStrong2

6

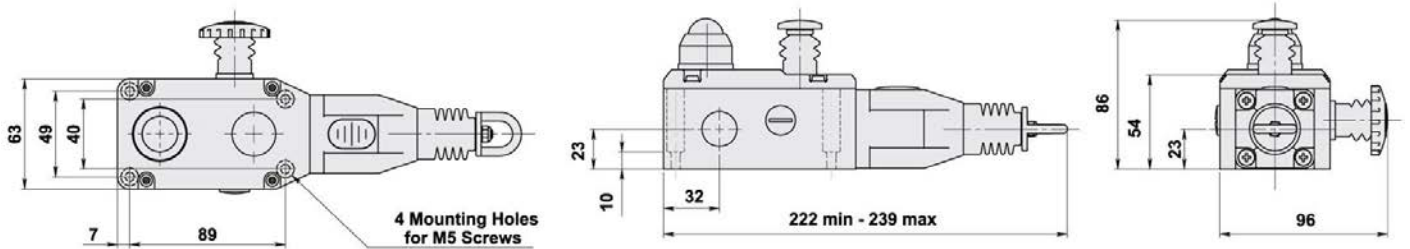

LineStrong3L-R

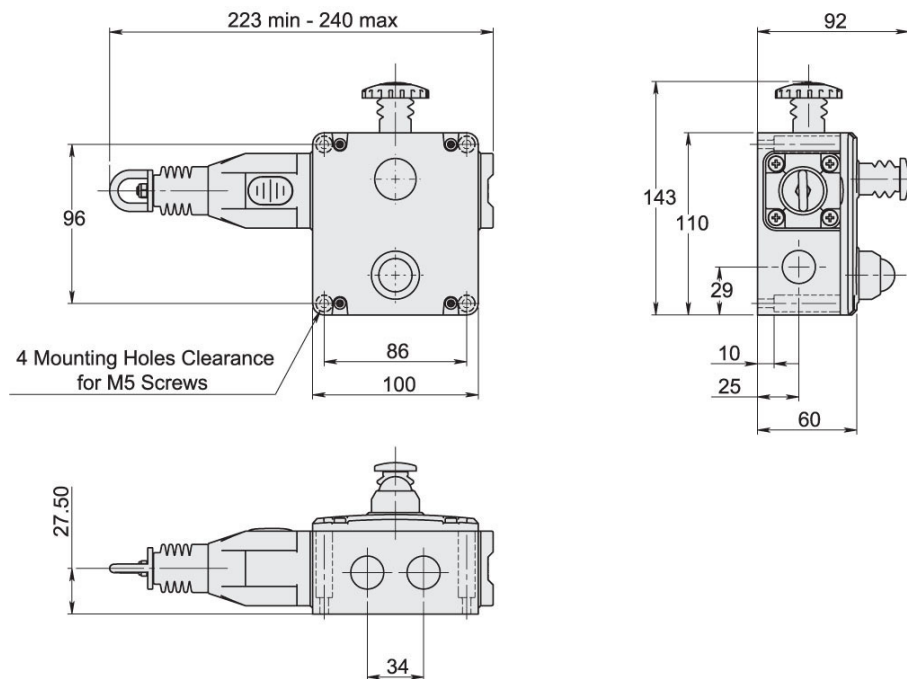

All dimensions in mm

Push-button box Smile 41

Smile 41 is a push-button box that gathers push buttons, an emergency stop button and a safe key selector in a single compact device with only one M12 connector for all functions.

Smile 41 push-button box is available in models for use with Pluto programmable safety controller and models for all types of AS-i safety monitors.

A kit of colored filters is supplied and the color of each button can be chosen after delivery and changed later.



6



Easy to install

Easy to attach to profiles

The centered mounting holes makes Smile 41 easy to attach to e.g. aluminum extrusions profiles like Quick-Guard.

Quick installation

The four buttons are connected with only one M12 connector which speeds up the connection. A maximum of 8 wires need to be connected for the complete push-button box with LEDs. The AS-i models also offer the flexibility of vampire connectors with piercing technology and self-healing cables.

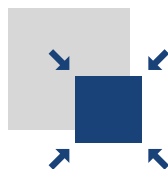

Space saving

Compact housing

A compact and appealing housing saves space and makes it easy to place.

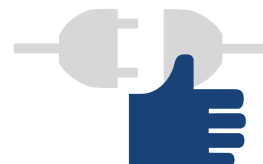

Optimum interface

LED indication

All push-buttons and emergency stop buttons are illuminated. The lighting of the push-buttons can easily be managed by the Pluto programmable safety controller, allowing a greater adaptation to the needs.

Several button colors

The color of each button can be chosen after delivery and changed later.

Applications and features

Smile 41

Applications

Smile 41 is a convenient way to gather several buttons at the same place while reducing cabling and installation. For example, an emergency stop button, a push button used to request the unlocking of the door, a push button used as reset button, and a push button used as start button.

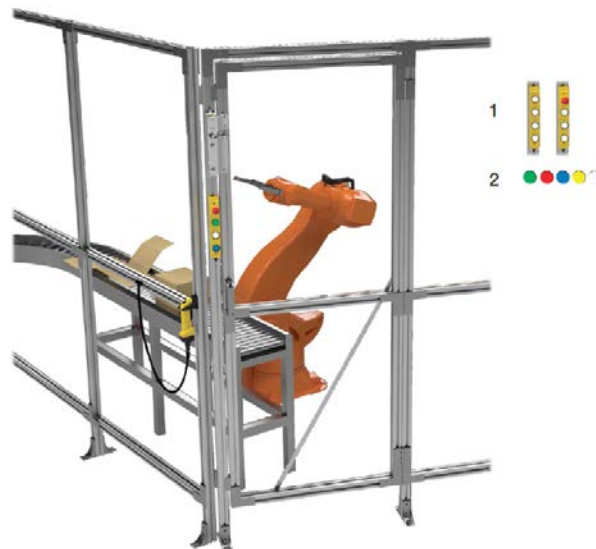

Features

With Pluto programmable safety controller without AS-i function

The Smile 41 models without AS-i function have been developed for use with Pluto programmable safety controller and allow to get all the advantages of the Pluto “light-button function”: only one I/O (IQ) is necessary for both a push-button and its LEDs and the lighting of the reset buttons can be handled by Pluto without any extra programming.

The emergency stop button satisfies the highest level of safety, and although only one cable is used for the signals of the four buttons, a possible short-circuit can be detected by Pluto and the highest level of safety can be reached.

Kit of colored filters

A kit of colored filters is supplied with all models and the color of each push button can be chosen after delivery and changed later.



With AS-i safety monitor e.g. Pluto AS-i and Pluto B42 AS-i

All AS-i models of Smile 41 can be used with any AS-i safety monitor. The AS-i system significantly reduces the necessary cable lengths and the M12 connector speeds up the connection. The vampire connectors with piercing technology and self-healing cables facilitate changes.

Both the safe key selector and the emergency stop button satisfy the highest level of safety. Moreover, the use of AS-i Safety makes it easy to reach the highest level of safety while eliminating most risks of connection mistakes.

The push buttons and the emergency stop button are equipped with an easily programmed LED for a perfect adaptation to the needs of the application, a better user friendliness and easier troubleshooting.

Centered mounting holes

Centered mounting holes facilitate the mounting of Smile 41 on aluminum profiles like Quick-Guard.

Ordering information

Smile 41



Smile 41 WWWWP

2TLC172719F0201

Smile 41 push button box

All Smile 41 push-button boxes are delivered with a kit of filters

Safety controller	Emergency stop button	Other buttons	Connector	Type	Order code
Pluto programmable safety controller	0	4 push-buttons	M12-8 male	Smile 41 WWWWP	2TLA030057R0000
	1	3 push-buttons	M12-8 male	Smile 41 EWWWP	2TLA030057R0100
AS-i monitor*	0	4 push-buttons	M12-5 male	Smile 41 WWWWN ASi	2TLA030056R0000
		3 push-buttons	M12-5 male	Smile 41 EWWWA ASi	2TLA030056R0100
	1	1 safe key selector 2 push-buttons	M12-5 male	Smile 41 EKWWA ASi	2TLA030056R0200

* E.g. Pluto AS-i and Pluto B42 AS-i



Smile 41 EWWWP

2TLC172717F0201



Smile 41 WWWWN AS-i

2TLC172609F0201

Spare parts

Description	Type	Order code
Kit of colored filters	Colored filters	2TLA030059R2600

6



Smile 41 EWWWA AS-i

2TLC172609F0201



Smile 41 EKWWA AS-i

2TLC172709F0201

Cables and connectors

Smile 41



M12-C61

2TLC172951F0201



M12-C61HE

2TLC010038F0201



M12-C334

2TLC172931F0201

Cable with connectors

Connector	Female/male	Length	Special feature	Type	Order code
M12-5	Female	6 m		M12-C61	2TLA020056R0000
		10 m	Harsh environment, halogen free	M12-C61HE	2TLA020056R8000
		10 m		M12-C101	2TLA020056R1000
		20 m	Harsh environment, halogen free	M12-C101HE	2TLA020056R8100
	Female + male	0.3 m		M12-C0312	2TLA020056R5800
		0.06 m		M12-C00612	2TLA020056R6300
		1 m		M12-C112	2TLA020056R2000
		3 m		M12-C312	2TLA020056R2100
		6 m		M12-C612	2TLA020056R2200
		10 m		M12-C1012	2TLA020056R2300
			Angled female connector	M12-C1012V2	2TLA020056R6700
		16 m		M12-C1612	2TLA020056R5400
		20 m		M12-C2012	2TLA020056R2400
M12-8	Female	6 m		M12-C63	2TLA020056R3000
		10 m		M12-C103	2TLA020056R4000
		20 m		M12-C203	2TLA020056R4100
	Female + male	0.06 m		M12-C00634	2TLA020056R6400
		1 m		M12-C134	2TLA020056R5000
		3 m		M12-C334	2TLA020056R5100

6

Separate cables and connectors

Description	Type	Order code
Connectors		
M12-5 pole female, straight	M12-C01	2TLA020055R1000
M12-5 pole male, straight	M12-C02	2TLA020055R1100
M12-8 pole female, straight	M12-C03	2TLA020055R1600
M12-8 pole male, straight	M12-C04	2TLA020055R1700



M12-C01

2TLC172857F0201



C5 cable

2TLC010038F0201

Cable with 5 conductors

10 m cable with 5 x 0.34 shielded conductors	C5 cable 10 m	2TLA020057R0001
50 m cable with 5 x 0.34 shielded conductors	C5 cable 50 m	2TLA020057R0005
100 m cable with 5 x 0.34 shielded conductors	C5 cable 100 m	2TLA020057R0010
200 m cable with 5 x 0.34 shielded conductors	C5 cable 200 m	2TLA020057R0020
500 m cable with 5 x 0.34 shielded conductors	C5 cable 500 m	2TLA020057R0050

Cable with 8 conductors

50 m cable with 8 x 0.34 shielded conductors	C8 cable 50 m	2TLA020057R1005
100 m cable with 8 x 0.34 shielded conductors	C8 cable 100 m	2TLA020057R1010
200 m cable with 8 x 0.34 shielded conductors	C8 cable 200 m	2TLA020057R1020
500 m cable with 8 x 0.34 shielded conductors	C8 cable 500 m	2TLA020057R1050

Cables and connection accessories for AS-i

Description	Type	Order code
Cable for AS-i, power and data, +30 VDC, yellow, EPDM	AS-i cable yellow	2TLA020074R9000
Cable for AS-i, additional power, +24 VDC, black, EPDM	AS-i cable black	2TLA020074R9100
M12-5 female connector with vampire connector for AS-i flat cable.	AS-i T-connector M12	2TLA020073R0000
AS-i flat cable splitter used to make T-connections and to extend cables.	AS-i splitter box	2TLA020073R0300





AS-i cable yellow

2TLC172742F0201

Technical data

Smile 41

Technical data

	Smile 41	Smile 41 AS-i
Approvals	TÜV NORD 	TÜV NORD  
Conformity	CE 2006/42/EC - Machinery EN 61508:2010 parts 1-7, EN 62061:2005, EN ISO 13849-1:2008, EN ISO 13849-2:2012, 60947-5-5:2005	
Functional safety data		
IEC 61508:2010	Up to SIL3, depending on system architecture	SIL3, $PFH_D = 2.87 \times 10^{-10}$
EN/IEC 62061:2005	Up to SILCL3, depending on system architecture	SILCL3, $PFH_D = 2.87 \times 10^{-10}$
EN ISO 13849-1:2008	Up to Cat. 4/PL e, depending on system architecture	Cat. 4/PL e, $PFH_D = 2.87 \times 10^{-10}$
B10 _d	65 000	
Electrical data		
Operating voltage	+24 VDC ± 15%	+30 VDC (AS-i bus)
Mechanical data		
Mechanical life		
Emergency stop button	> 50 000 operations	
Illuminated push button	1 000 000 operations	
Key selector	-	30 000
Operating temperature	-25... +50 °C	
Protection class	IP65	
Weight	190 g	

More information

For more information, e.g. the complete technical information, see product manual for:

Smile 41 [2TLC172280M0201](#)

Smile 41 AS-i [2TLC172255M0201](#)

Dimension drawings Smile 41

Smile 41

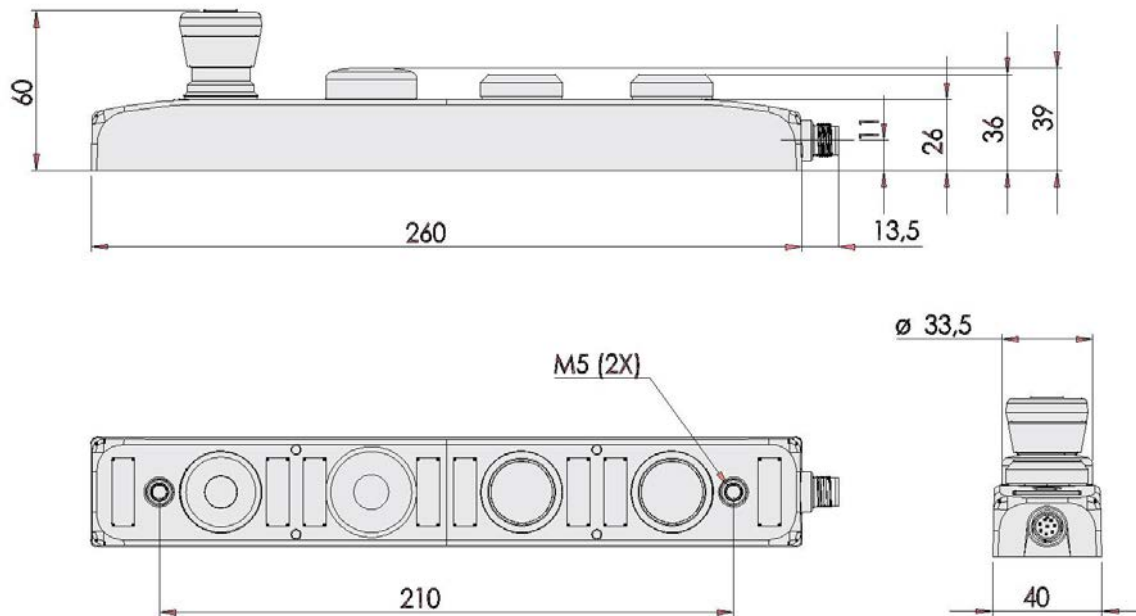

Smile 41 AS-i

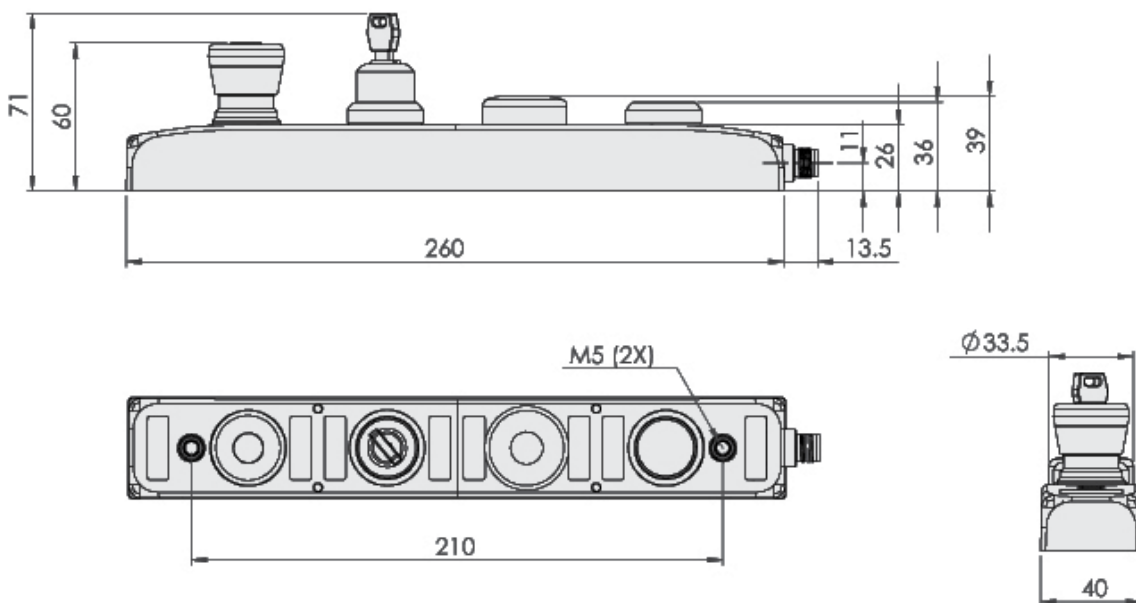

All dimensions in mm

Reset button Smile

Smile reset buttons have compact housings with M12 connectors for easy connection.

The reset button contains an integrated white LED, and all buttons are delivered with a kit of colored filters to snap on the top of the button. In this way the color of the button can be chosen after delivery and is also possible to be changed later.

The different models also allow a choice of:

- local reset connected directly to the sensor, or
- global reset connected to the safety control module.



6



Easy to install

Easy to attach to profiles

The centered mounting holes make Smile easy to attach to e.g. aluminum extrusions profiles.

Speed up installation

The housing requires no assembly and the M12 connectors speed up installation and reduce the risk of connection error.

Local reset

Local reset allows to have the reset button close to the safety device while reducing cabling.

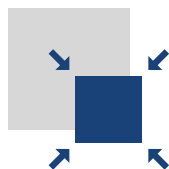

Space saving

Compact housing

A compact and appealing housing saves space and makes it easy to place.

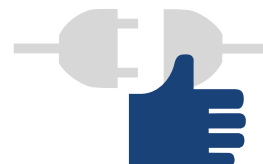

Optimum interface

Several button colors

All reset buttons are illuminated with a white LED and the color of each button can be chosen after delivery and changed later using colored snap-on filters.

Ordering information

Smile reset buttons



Smile 11 RO1

2TLC172018V0201

Ordering details

Type of contact	Intended use	Connectors	Type	Order code
1 NO	Most reset applications	M12-5 male	Smile 11 RA	2TLA030053R0000
1 NO	Pluto Safety PLC light button function*	M12-5 male	Smile 11 RB	2TLA030053R0100
1 NO	Local reset of Orion1 Base	M12-5 male	Smile 11RO1	2TLA022316R3000
1 NC	Local reset of Orion2 Base and Extended, and Orion3 Extended	M12-5 male	Smile 11RO2	2TLA022316R3100
1 NC	Local reset of Orion3 Base	M12-5 male	Smile 11RO3	2TLA022316R3200
1 NO	Local reset of Eden DYN-Reset M12-5 and Eden OSSD-Reset M12-5	M12-5 male + female	Smile 12 RF	2TLA030053R2600
1 NO	Local reset of Eden OSSD-Reset M12-8	M12-8 male + female	Smile 12 RG	2TLA030053R2700

* See Pluto hardware manual for more information about the light button function



M12-3x

2TLC172623F0201



Tina 10B

2TLC172475F0201

Accessories

Description	Type	Order code
Y-connector for series connection of DYNlink devices with M12-5 connectors, e.g. Eden.	M12-3A	2TLA020055R0000
Y-connector for series connection of Adam OSSD M12-8 with M12-5 cables	M12-3H	2TLA020055R0800
Y-connector for series connection of Adam OSSD M12-8 with M12-8 cables	M12-3G	2TLA020055R0700
Y-connector for connection of Smile reset button to Orion.	M12-3R	2TLA022316R0000
Adaptation unit of OSSD outputs to DYNlink signals for use with Vital control module or Pluto Safety PLC. Tina 10B has an extra M12 connector for connection of a reset button.	Tina 10B	2TLA020054R1300



Colored filters

2TLC172725F0201

Spare parts

Description	Type	Order code
Kit of colored filters (yellow, green, white, blue, red)	Colored filters	2TLA030059R2600

Cables

Smile reset buttons

Cables for Smile 12 RF (with Eden DYN/OSSD Reset M12-5)

Description	Female/male	Length	Type	Order code	Eden Reset M12-5 to Smile 12 RF	Smile 12 RF to M12-3A	M12-3A to M12-3A	El-cabinet to M12-3A	M12-3A to el-cabinet	
M12-5	Female	6 m	M12-C61	2TLA020056R0000				X		
		10 m	M12-C101	2TLA020056R1000				X		
		20 m	M12-C201	2TLA020056R1400				X		
	Female + male	1 m	M12-C112	2TLA020056R2000		X	X	X		
		3 m	M12-C312	2TLA020056R2100		X	X	X		
		6 m	M12-C612	2TLA020056R2200		X	X	X		
		10 m	M12-C1012	2TLA020056R2300		X	X	X		
		20 m	M12-C2012	2TLA020056R2400		X	X	X		
	Male	6 m	M12-C62	2TLA020056R0200						X
		10 m	M12-C102	2TLA020056R1200						X

6

Cables for Smile 12 RG (with Eden DYN/OSSD Reset M12-8)

Connector	Female/male	Length	Type	Order code	Eden Reset M12-8 to Smile 12 RG	Smile 12 RG to M12-3G or M12-3H	M12-3G to M12-3G	El-cabinet to M12-3G	M12-3G to el-cabinet	M12-3H to M12-3H	El-cabinet to M12-3H	M12-3H to el-cabinet	
M12-5	Female	6 m	M12-C61	2TLA020056R0000							X		
		10 m	M12-C101	2TLA020056R1000							X		
		20 m	M12-C201	2TLA020056R1400							X		
	Female + male	1 m	M12-C112	2TLA020056R2000							X		
		3 m	M12-C312	2TLA020056R2100							X		
		6 m	M12-C612	2TLA020056R2200							X		
		10 m	M12-C1012	2TLA020056R2300							X		
		20 m	M12-C2012	2TLA020056R2400							X		
	Male	6 m	M12-C62	2TLA020056R0200									X
		10 m	M12-C102	2TLA020056R1200									X
M12-8	Female	6 m	M12-C63	2TLA020056R3000				X					
		10 m	M12-C103	2TLA020056R4000				X					
		20 m	M12-C203	2TLA020056R4100				X					
	Female + male	1 m	M12-C134	2TLA020056R5000		X	X	X					
		3 m	M12-C334	2TLA020056R5100		X	X	X					
	Male	By meter	M12-C04	2TLA020055R1700					X				

Cables for Smile 11 Rx and ROx

Connector	Female/male	Length	Type	Order code	Smile 11 Rx to another M12	Smile 11 Rx to el-cabinet	Smile 11 ROx to Tina 10B	Tina 10B to el-cabinet	Smile 11 ROx to M12-3R	M12-3R to el-cabinet	Tina 10B to M12-3A	M12-3A to M12-3A	El-cabinet to M12-3A	M12-3A to el-cabinet	
M12-5	Female	6 m	M12-C61	2TLA020056R0000		X		X		X			X		
		10 m	M12-C101	2TLA020056R1000		X		X		X			X		
		20 m	M12-C201	2TLA020056R1400		X		X		X			X		
	Female + male	1 m	M12-C112	2TLA020056R2000		X	X		X		X	X			
		3 m	M12-C312	2TLA020056R2100		X	X		X		X	X			
		6 m	M12-C612	2TLA020056R2200		X	X		X		X	X			
		10 m	M12-C1012	2TLA020056R2300		X	X		X		X	X			
		20 m	M12-C2012	2TLA020056R2400		X	X		X		X	X			
	Male	6 m	M12-C62	2TLA020056R0200											X
		10 m	M12-C102	2TLA020056R1200											X

Connection examples

Smile reset buttons

Local reset to Orion with Tina 10A/C

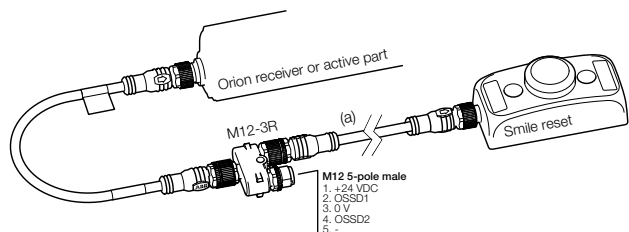

Connection of Smile 11 ROx to Orion through M12-3R. For connection to any control module compatible with OSSD outputs.

Local reset to Orion with Tina 10B

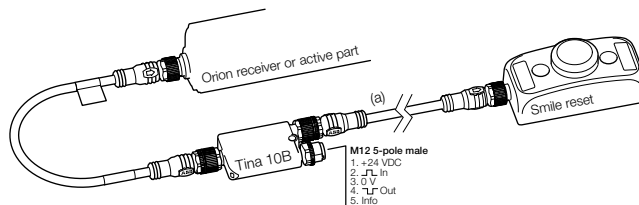

Connection of Smile 11 ROx to Orion through Tina 10B. For connection to Vital control module or Pluto Safety PLC.

Local reset to Eden



Serial connection of Eden with local Smile reset buttons:

- Adam OSSD-Reset M12-8 with Smile 12 RG and M12-3G or M12-3H
- Adam DYN-Reset with Smile 12 RF and M12-3A

Global vs local reset

A global reset is connected directly to the control cabinet with separate cables. The safety controller in the control cabinet supervises the reset and decides the function and actions.

A local reset is connected directly to the safety device, and requires no communication with the control cabinet. The safety device supervises the reset and decides the actions. A local reset simplifies installation and minimizes cabling.

Technical data

Smile reset buttons

Approvals	
Power supply	
LED operating voltage	+24 VDC (maximum +33 VDC)
LED current consumption	20 mA at +24 VDC, 30 mA at +33 VDC
Push button operating voltage	Min: +5 V, max: +35 V
Push button current	Min: 1 mA, max: 100 mA
Push button rated power	Max: 250 mW
Mechanical data	
Color - Enclosure	Yellow
Color - Push button	White
Material - Housing	Polypropylene PP
Material - Contact	Au
Weight	Approx. 60 g
Protection class	IP65
Mechanical life	1 000 000 operations at 10 mA / +24 VDC
Switching reliability	10×10^6 at 5 mA / +24 VDC
Environmental data	
Ambient temperature	-25...+55 °C
Humidity range	35 to 85% (with no icing or condensation)

6

More information

For more information, e.g. the complete technical information, see product manual for:
Smile reset buttons [2TLC172097M0201](#)

Dimension drawings

Smile reset buttons

Smile 11 R

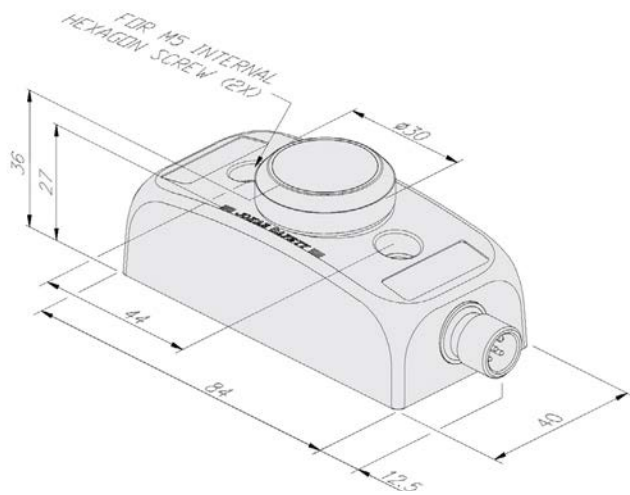

Smile 12 R

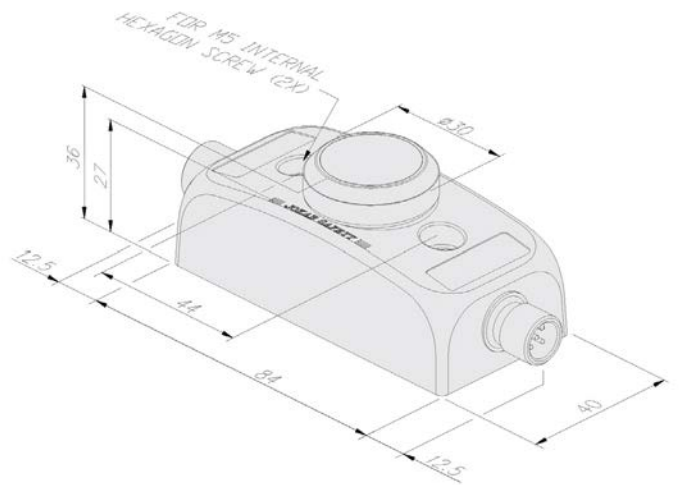

All dimensions in mm



Fence



Introduction and overview

Selection guide	7/2
Fencing system – Quick-Guard	7/4

Introduction and overview

Selection guide

Quick-Guard is an ABB fencing solution with endless possibilities.

	Quick-Guard Standard	Quick-Guard Express
Image		
Type	Aluminum fencing system	Aluminum fencing system
Description	Custom made fence with endless possibilities	Fence with few components and quick installation
Application	Fence designed and delivered according to drawing with mesh, solid or noise reduction panels	Fence sections with mesh or polycarbonate with possibility to modify on site
Advantage	<ul style="list-style-type: none"> - Custom design for each machine - Highly adaptable - Can be delivered preassembled - Mounting brackets for Jokab Safety sensors 	<ul style="list-style-type: none"> - Fast installation - Minimum number of components - Cost effective - Can be cut and modified on site - Possible to adjust angles ± 45 degrees - Mounting brackets for Jokab Safety sensors

7

Fencing system Quick-Guard

Quick-Guard is a very flexible fencing system used for machine enclosure or preventing access to a hazardous area.

It consists of a minimum of different components, such as aluminum profiles, patented assembly parts, net-locks, mesh, solid or noise reduction panels.

Thanks to our patented screw-lock system, we can supply all brackets pre-mounted with fixing screws and nuts. No holes need to be drilled in the profiles and all cuts are made straight. This makes assembly and modification very easy.



7



Easy to install

Aluminum profiles

Lightweight aluminum profiles allow ergonomic assembly.

Patented screw-lock system

Pre-mounted brackets with fixing screws and nuts simplifies assembly and modification.

Simple modification

It is easy to modify an existing fence design since the aluminum profiles are easy to saw into different lengths.



Speed up your projects

Highly adaptable to various needs

Numerous materials and components give endless possibilities.

Complete safety system

Quick-Guard has fittings and mounting brackets for all sensors, locks and switches from Jokab Safety.

Applications and features

Quick-Guard

Applications

Quick-Guard fencing system is designed to be used in different types of applications and can be customized to suit specific needs. Quick-Guard can be supplied to be designed by you on site (Quick-Guard Express) or designed and cut according to drawing (Quick-Guard standard). These two fencing system can also be combined to achieve a complete system.

Simple fencing for on site adaption

Quick-Guard Express is installed quickly and cost effectively. You order sections consisting of a few components which make it easy for you to install the fencing system by yourself on site. A manual mesh clipping tool, for easy cutting of the mesh, can be ordered if needed.

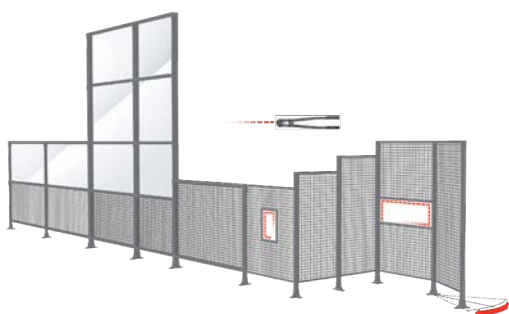

Advanced enclosure with endless possibilities

When ordering a **Quick-Guard standard** fencing system, you give us a simple sketch or AutoCAD® file of how you want the fencing system to look. We put this information into our AutoCAD-based software SafeCAD and design the fence in 3D. Cutting, component lists and quotations are generated automatically from SafeCAD.

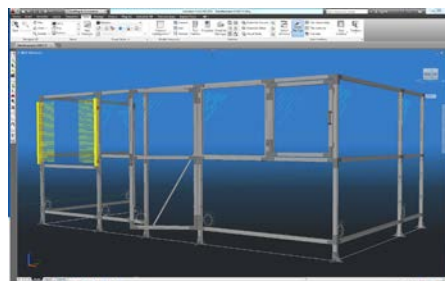

Features

Patented assembly function

Our patented guide and locking method makes it simple to assemble and dismantle the fencing system. The nut has several advantages, it can easily be located into the profile and automatically positions itself when the screw is turned 90 degrees clockwise. When in this position the bracket being fixed can be adjusted as required and locked by turning the screw further clockwise. To remove the bracket the fixing screw is turned counterclockwise until the nut is in line with the profile slot.

All of our sensors, light grids, emergency stops and control devices are easy to mount, adjust and dismount in the profile's T-slot thanks to our special nuts. Because we don't have to drill in the profile, there are no marks if you want to move a sensor or rebuild.

SafeCAD

SafeCAD is a plug-in program for AutoCAD that enables you to quickly and easily customize safety solutions with our fencing system Quick-Guard. A simple sketch of the guarding system is used as the program input. The positions of doors and hatches, choice of mesh, polycarbonate, aluminum/steel sheet or noise reduction panels are typed in. The program automatically generates 3D drawings along with component and cutting lists. These drawings are also used as the basis for assembly/installation.

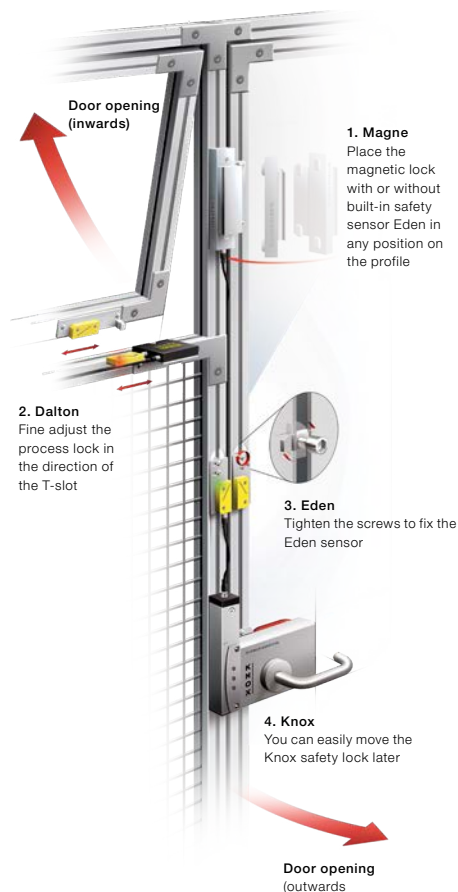

Ordering information

Quick-Guard Express

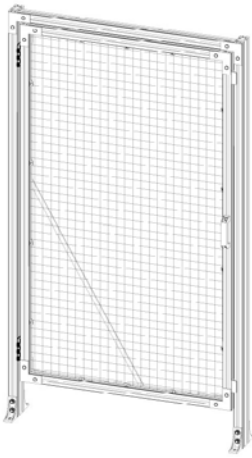

2TLC172318F0201

JSM E11-N20G

Express sections

Description	Material	Profile mm	Width (CC) mm	Type	Order code
Express sections height 2000					
Section with one profile	Mesh	44 x 44	1100	JSM E11-N20X4	2TLA040101R0200
		44 x 88	1100	JSM E11-N20X8	2TLA040101R0300
			1500	JSM E15-N20X8	2TLA040101R0900
	Mesh and polycarbonate	44 x 88	1100	JSM E11-N/PC20X8	2TLA040104R0100
Section with two profiles	Mesh	44 x 88	1500	JSM E15-N20H8	2TLA040101R0800
Section without profiles (incl. netlocks and edge protection)	Mesh	-	1100	JSM E11-N20Z	2TLA040101R0400
		-	1500	JSM E15-N20Z	2TLA040101R1000
	Mesh and polycarbonate	-	1100	JSM E11-N/PC20Z	2TLA040104R0200
Door section (incl. Floorbrackets and netlocks)	Mesh	44 x 44 / 44 x 88	1100	JSM E11-N20G	2TLA040101R0500
	Mesh and polycarbonate	44 x 44 / 44 x 88	1100	JSM E11-N/PC20G	2TLA040104R0300
Sliding door section (incl. Suspension wheels, guiding components, floor brackets and netlocks)	Mesh	44 x 44 / 44 x 88	1100	JSM E11-N20S	2TLA040101R0600
	Mesh	44 x 44 / 44 x 88	1500	JSM E15-N20S	2TLA040101R1100
	Mesh and Polycarbonate	44 x 44 / 44 x 88	1100	JSM E11-N/PC20S	2TLA040104R0400

Express sections height 2200

Section with one profile	Mesh	44 x 44	1100	JSM E11-N20X4	2TLA040102R0200
		44 x 88	1100	JSM E11-N20X8	2TLA040102R0300
			1500	JSM E15-N22X8	2TLA040102R0800
	Mesh and polycarbonate	44 x 88	1100	JSM E11-N/PC22X8	2TLA040105R0100
Section without profiles (incl. netlocks and edge protection)	Mesh	-	1100	JSM E11-N22Z	2TLA040102R0400
		-	1500	JSM E15-N22Z	2TLA040102R0900
	Mesh and polycarbonate	-	1100	JSM E11-N/PC22Z	2TLA040105R0200
Door section (incl. Floorbrackets and netlocks)	Mesh	44 x 44 / 44 x 88	1100	JSM E11-N22G	2TLA040102R0500
	Mesh and polycarbonate	44 x 44 / 44 x 88	1100	JSM E11-N/PC22G	2TLA040105R0300
Sliding door section (incl. Suspension wheels, guiding components, floor brackets and netlocks)	Mesh	44 x 44 / 44 x 88	1100	JSM E11-N22S	2TLA040102R0600
	Mesh	44 x 44 / 44 x 88	1500	JSM E15-N22S	2TLA040102R1000
	Mesh and Polycarbonate	44 x 44 / 44 x 88	1100	JSM E11-N/PC22S	2TLA040105R0400

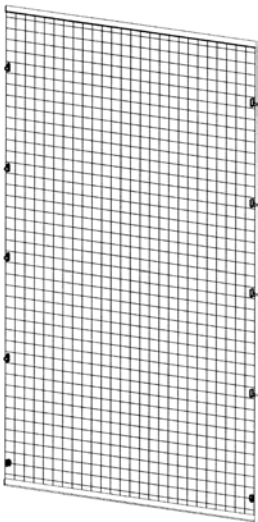

2TLC172318F0201

JSM E15-N20Z

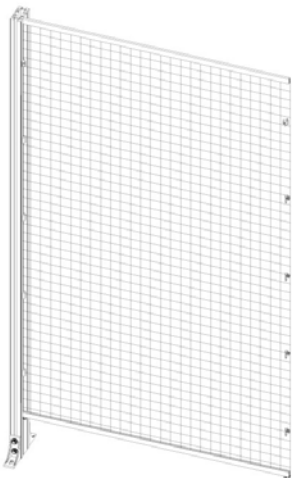

2TLC172313F0201

JSM E15-N22X8

Ordering information

Quick-Guard Express



JSM E11-20Y4

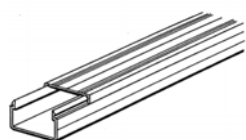

JSM A25

2TLC172235F0201

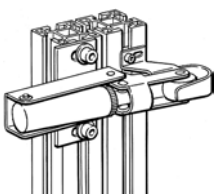

JSM D3

2TLC172255F0201

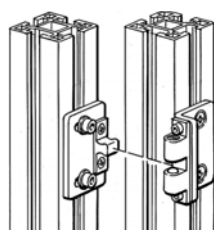

JSM D11B

2TLC172269F0201

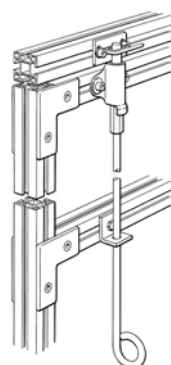

JSM D10A

2TLC172287F0201

Accessories

Description	Height mm	Profile mm	Type	Order code
Section profile incl. two floor brackets and one support screw	2000	44 x 44	JSM E11-20Y4	2TLA040103R2000
		44 x 88	JSM E11-20Y8	2TLA040103R2100
	2200	44 x 44	JSM E11-22Y4	2TLA040103R4000
		44 x 88	JSM E11-22Y8	2TLA040103R4100
Emergency exit opener for conventional doors with 600-1270 mm openings. Suitable for both right-and left-hand doors.			Panic Exit Device P-1165	2TLA040033R7000
Lever handle for Panic Exit Device. Three keys are included.			Lever Handle for Panic Exit Device	2TLA040033R7100
Mounting kit for Panic Exit Device. Brackets in stainless steel, delivered pre-assembled.			Mounting kit for Panic Exit Device	2TLA040033R7200
Cable duct 44 x 25 mm with holes c-c = 500 mm diameter = 5. Natural anodized aluminum. Length 2000 mm.			JSM A25A	2TLA040037R1300
Cable duct 88 x 68 mm without holes. Natural anodized aluminum. Length 2000 mm.			JSM A88	2TLA040037R3300
Cable duct 44 x 60 mm with holes c-c = 500 mm diameter = 5. Natural anodized aluminum. Length 2000 mm.			JSM A60A	2TLA040037R1500
Door closer incl. mounting components, for conventional door/hatch.			JSM D3	2TLA040033R0200
Door closer incl. mounting components, for sliding door.			JSM D19	2TLA042020R5600
Ball latch for conventional door/hatch.			JSM D11B	2TLA040033R4100
Ball latch for sliding door.			JSM D11C	2TLA040033R4200
Door bolt with spring for catch above the door (included). Brackets in zinc-plated steel, rod in stainless steel. Total height 1130 mm.			JSM D10A	2TLA040033R2100
Door bolt with spring for hole in floor. Brackets in zinc-plated steel, rod in stainless steel. Total height 995 mm.			JSM D10B	2TLA040033R3800
Cam lock including fitting. Brackets in aluminum and lock unit in black polyamide. Keys are excluded.			JSM D15	2TLA040033R3900
Key to fit JSM D15 in black zinc.			JSM D16	2TLA040033R4400
Bracket for padlock hasp, zinc plated steel. Two pieces needed for one complete unit.			JSM D17	2TLA042020R2200
Special nut, M4 galvanized.			JSM M4B	2TLA040035R0700
Special nut, M5 galvanized.			JSM M5B	2TLA040035R0400
Special nut, M6 galvanized.			JSM M6B	2TLA040035R0500
Special nut, M8 galvanized.			JSM M8B	2TLA040035R0600

More information

For components and ordering information for Quick-Guard standard please see the website <http://new.abb.com/low-voltage/products/safety-products/fencing-systems/quick-guard>

Contact us

ABB AB

Jokab Safety

Varlabergsvägen 11

SE-434 39 Kungsbacka

Tel. +46 (0) 21-32 50 00

You can find the address of your local sales organization on the **ABB home page**



www.abb.com



www.abb.com/jokabsafety

Note

We reserve the right to make technical changes or modify the contents of this document without prior notice.

With regard to purchase orders, the agreed particulars shall prevail. ABB does not accept any responsibility whatsoever for potential errors or possible lack of information in this document.

We reserve all rights in this document and in the subject matter and illustrations contained therein. Any reproduction, disclosure to third parties or utilization of its contents – in whole or in parts – is forbidden without prior written consent of ABB.

Copyright © 2017 ABB
All rights reserved