



Catalog

# Spare parts for contactors, R contactors, softstarters and arc guard

Power and productivity  
for a better world™





# Contents Overview

<a href="#">Spare parts contactors</a>	1
<a href="#">Spare parts R contactors</a>	2
<a href="#">Spare parts softstarters</a>	3
<a href="#">Spare parts arc guard</a>	4



# Spare parts contactors

## Active products

### A, AF, AE, TAE, UA, UA...RA contactors and contactors relays

Main contact sets	1/2
Arc chutes	1/3
LVRT	1/3
Contactors coils	1/4
Spare parts cover	1/6
Spare parts bottom	1/7
Service kit	1/7
Contactors bridge	1/7

## Classic products

### EH, EHDB, EK contactors

3-pole contactors type EH	1/8
Drive contactors type EHDB	1/8
Main contact sets	1/9
Connection sets	1/10
Arc Chute	1/11
Terminal shrouds (LT. )	1/12
Terminal extensions (LX.)	1/12
Terminal enlargements (LW.)	1/12
Terminal connecting strips (LY.)	1/12
Mounting plates	1/13
Adapter plates	1/14
Mechanical and electrical interlocking units	1/15
Contactors coils	1/16
Coil codes EH/KH..	1/17
Coil codes EK/KH.. and EHDB/KH..	1/18
Surge suppressors	1/19
Auxiliary contact blocks	1/20

# Spare parts contactors

## Active products

1

### Main contact sets

#### Ordering details

For contactors	Type	Order code	Pkg qty	Weight (1 pce) kg
----------------	------	------------	---------	-------------------

#### Main contact sets for 3-pole contactors

consists of six fixed contacts, three moving contacts, springs and the required screws.

A/AF/AE/TAE50-30	ZL50	1SBN163503R1000	1	0.115
A/AF/AE/TAE63-30	ZL63	1SBN163703R1000	1	0.130
A/AF/AE/TAE75-30	ZL75	1SBN164103R1000	1	0.145
A/AF95-30	ZL95	1SFN164303R1000	1	0.190
A/AF110-30	ZL110	1SFN164503R1000	1	0.190
A/AF145	ZL145	1SFN164703R1000	1	0.380
A/AF185	ZL185	1SFN164903R1000	1	0.380
A/AF210	ZL210	1SFN165103R1000	1	0.670
A/AF260	ZL260	1SFN165303R1000	1	0.670
A/AF300	ZL300	1SFN165503R1000	1	0.670
AF400	ZL400	1SFN165703R1000	1	1.320
AF460	ZL460	1SFN165903R1000	1	1.320
AF580	ZL580	1SFN166103R1000	1	1.840
AF750	ZL750	1SFN166303R1000	1	1.840
AF1250	ZL1250	1SFN166403R1000	1	1.840
AF1350	ZL1350	1SFN166503R1000	1	3.500
AF1350-1 (1)	ZL1350-1	1SFC166503R1001	1	4.500
AF1650	ZL1650	1SFN166703R1000	1	3.500
AF1650-1 (1)	ZL1650-1	1SFN166703R1001	1	4.500
AF2050	ZL2050	1SFN167003R1000	1	3.500
AF2050-1 (1)	ZL2050-1	1SFN167003R1001	1	4.500
AF2650 (2)	ZL2650	1SFN166603R1000	1	1.200

(1) From contactor with serial number 1S1601001403xxx

(2) Do not include fixed parts or screws

#### Main contact sets for 4-pole contactors

consists of eight fixed contacts, four moving contacts, springs and the necessary screws.

A/AE/AF45-40	ZLT45	1SBN163304R1000	1	0.150
A/AE/AF50-40	ZLT50	1SBN163504R1000	1	0.150
A/AE/AF75-40	ZLT75	1SBN164104R1000	1	0.150



ZL185

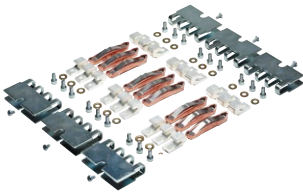

ZL1650

# Spare parts contactors

## Active products

### Arc chutes

#### Ordering details

For contactors

	Type	Order code	Pkg qty	Weight (1 pce) kg
A145 ... A185 and AF145 ... AF185	ZW185	1SFN164710R1000	1	0.360
A210 ... A300 and AF210 ... AF300	ZW300	1SFN165110R1000	1	0.410
AF400, AF460	ZW460	1SFN165710R1000	1	1.380
AF580, AF750, AF1250	ZW750	1SFN166110R1000	1	1.500
AF1350, AF1650, AF2050 (1)	ZW1650	1SFN166510R1001	1	4.560
AF2650	ZW2650	1SFN166610R1000	1	4.000

(1) Fits old and new version



ZW

# Spare parts contactors

## Active products

1

### Contactor coils AC operated

#### Ordering details

For contactors	Rated control circuit		Type	Order code	Pkg qty	Weight (1 pce) kg	
	Voltage Uc V 50 Hz	V 60 Hz					
<b>Coils type ZA for A9 ... A300 AC operated contactors and N contactor relays</b>							
A9 ... A16, UA16, UA16..RA, N	24	24	ZA16	1SBN151410R8106	1	0.093	
	48	48	ZA16	1SBN151410R8306	1	0.093	
	105	110 ... 127	ZA16	1SBN151410R2606	1	0.093	
	110	110 ... 120	ZA16	1SBN151410R8406	1	0.093	
	110 ... 115	115 ... 127	ZA16	1SBN151410R8906	1	0.093	
	175	208	ZA16	1SBN151410R3406	1	0.093	
	190	220	ZA16	1SBN151410R3606	1	0.093	
	200	200 ... 220	ZA16	1SBN151410R7506	1	0.093	
	220 ... 230	230 ... 240	ZA16	1SBN151410R8006	1	0.093	
	230 ... 240	240 ... 260	ZA16	1SBN151410R8806	1	0.093	
	380 ... 400	400 ... 415	ZA16	1SBN151410R8506	1	0.093	
	400 ... 415	415 ... 440	ZA16	1SBN151410R8606	1	0.093	
	A26 ... A40, UA26, UA30, UA26..RA, UA30..RA	24	24	ZA40	1SBN152410R8106	1	0.148
		48	48	ZA40	1SBN152410R8306	1	0.148
105		110 ... 127	ZA40	1SBN152410R2606	1	0.148	
110		110 ... 120	ZA40	1SBN152410R8406	1	0.148	
110 ... 115		115 ... 127	ZA40	1SBN152410R8906	1	0.148	
175		208	ZA40	1SBN152410R3406	1	0.148	
190		220	ZA40	1SBN152410R3606	1	0.148	
200		200 ... 220	ZA40	1SBN152410R7506	1	0.148	
220 ... 230		230 ... 240	ZA40	1SBN152410R8006	1	0.148	
230 ... 240		240 ... 260	ZA40	1SBN152410R8806	1	0.148	
380 ... 400		400 ... 415	ZA40	1SBN152410R8506	1	0.148	
400 ... 415		415 ... 440	ZA40	1SBN152410R8606	1	0.148	
A45 ... A75, UA50 ... UA75, UA50..RA ... UA75..RA, GA75		24	24	ZA75	1SBN153510R8106	1	0.166
		48	48	ZA75	1SBN153510R8306	1	0.166
	105	110 ... 127	ZA75	1SBN153510R2606	1	0.166	
	110	110 ... 120	ZA75	1SBN153510R8406	1	0.166	
	110 ... 115	115 ... 127	ZA75	1SBN153510R8906	1	0.166	
	175	208	ZA75	1SBN153510R3406	1	0.166	
	190	220	ZA75	1SBN153510R3606	1	0.166	
	200	200 ... 220	ZA75	1SBN153510R7506	1	0.166	
	220 ... 230	230 ... 240	ZA75	1SBN153510R8006	1	0.166	
	230 ... 240	240 ... 260	ZA75	1SBN153510R8806	1	0.166	
	380 ... 400	400 ... 415	ZA75	1SBN153510R8506	1	0.166	
	400 ... 415	415 ... 440	ZA75	1SBN153510R8606	1	0.166	
	A95, A110 UA95, UA110 UA95..RA, UA110..RA	24	24	ZA110	1SFN154310R8106	1	0.170
		48	48	ZA110	1SFN154310R8306	1	0.170
110		110 ... 120	ZA110	1SFN154310R8406	1	0.170	
220 ... 230		230 ... 240	ZA110	1SFN154310R8006	1	0.170	
230 ... 240		240 ... 260	ZA110	1SFN154310R8806	1	0.170	
380 ... 400		400 ... 415	ZA110	1SFN154310R8506	1	0.170	
400 ... 415		415 ... 440	ZA110	1SFN154310R8606	1	0.170	
A145 ... A185	24	24	ZA185	1SFN154710R8106	1	0.180	
	48	48	ZA185	1SFN154710R8306	1	0.180	
	110	110 ... 120	ZA185	1SFN154710R8406	1	0.180	
	220 ... 230	230 ... 240	ZA185	1SFN154710R8006	1	0.180	
	230 ... 240	240 ... 260	ZA185	1SFN154710R8806	1	0.180	
	380 ... 400	400 ... 415	ZA185	1SFN154710R8506	1	0.180	
	400 ... 415	415 ... 440	ZA185	1SFN154710R8606	1	0.180	
	A210 ... A300	24	24	ZA300	1SFN155110R8106	1	0.400
48		48	ZA300	1SFN155110R8306	1	0.400	
110		110 ... 120	ZA300	1SFN155110R8406	1	0.400	
220 ... 230		230 ... 240	ZA300	1SFN155110R8006	1	0.400	
230 ... 240		240 ... 260	ZA300	1SFN155110R8806	1	0.400	
380 ... 400		400 ... 415	ZA300	1SFN155110R8506	1	0.400	
400 ... 415		415 ... 440	ZA300	1SFN155110R8606	1	0.400	



ZA185

1SFT93095-01003



# Spare parts contactors

## Active products

### Contactors coils AC / DC operated

#### Ordering details

For contactors	Rated control circuit		Type	Order code	Pkg qty	Weight (1 pce)
	Voltage U <sub>c</sub>					
	V 50/60 Hz	V DC				kg

#### Coils type ZAF for AF45 ... AF2050 AC / DC operated contactors

AF45 ... AF75	-	20 ... 60	ZA16	1SBN151410R8106	1	0.170
	48 ... 130	48 ... 130	ZA16	1SBN151410R8306	1	0.170
	100 ... 250	100 ... 250	ZA16	1SBN151410R2606	1	0.170
AF95, AF110	-	20 ... 60	ZAF110	1SFN154370R7206	1	0.200
	48 ... 130	48 ... 130	ZAF110	1SFN154370R6906	1	0.200
	100 ... 250	100 ... 250	ZAF110	1SFN154370R7006	1	0.200
AF145, AF185	-	20 ... 60	ZAF185	1SFN154770R7206	1	0.225
	48 ... 130	48 ... 130	ZAF185	1SFN154770R6906	1	0.225
	100 ... 250	100 ... 250	ZAF185	1SFN154770R7006	1	0.225
AF210 ... AF300	-	20 ... 60	ZAF300	1SFN155170R7206	1	0.450
	48 ... 130	48 ... 130	ZAF300	1SFN155170R6906	1	0.450
	100 ... 250	100 ... 250	ZAF300	1SFN155170R7006	1	0.450
AF400, AF460	-	24 ... 60	ZAF460	1SFN155770R6806	1	0.525
	48 ... 130	48 ... 130	ZAF460	1SFN155770R6906	1	0.525
	100 ... 250	100 ... 250	ZAF460	1SFN155770R7006	1	0.525
	250 ... 500	250 ... 500	ZAF460	1SFN155770R7106	1	0.525
AF580 ... AF1250	-	24 ... 60	ZAF750	1SFN156170R6806	1	1.335
	48 ... 130	48 ... 130	ZAF750	1SFN156170R6906	1	1.335
	100 ... 250	100 ... 250	ZAF750	1SFN156170R7006	1	1.335
	250 ... 500	250 ... 500	ZAF750	1SFN156170R7106	1	1.335
AF1350 ... AF2050	100 ... 250	100 ... 250	ZAF1650 (1)	1SFN156570R7026	1 set	0.900
			ZP1650 (2)	1SFN166521R1070	1	0.300

(1) One set of two coil  
 (2) Printed circuit board



ZAF110



ZAF300



ZAF1650

### LVRT Low voltage ride through PCB

#### Ordering details

For contactors	Type	Order code	Pkg qty	Weight (1 pce)
AF1350 ... AF2650(T)		1SFN165503R6126		kg

# Spare parts contactors

## Active products

1

### Spare part cover

#### Ordering details

For contactor type	Type	Order code	Pkg qty	Weight (1 pce) kg
A145		1SFN165503R9201		0.365
A185		1SFN165503R9203		0.365
A210		1SFN165503R9205		0.520
A260		1SFN165503R9207		0.520
A300		1SFN165503R9209		0.520
AF145		1SFN165503R9202		0.365
AF185		1SFN165503R9204		0.365
AF210		1SFN165503R9206		0.520
AF260		1SFN165503R9208		0.520
AF300		1SFN165503R9210		0.520
AF400		1SFN165503R9211		1.455
AF460		1SFN165503R9212		1.455
AF580		1SFN165503R9213		1.655
AF750		1SFN165503R9214		1.655
AF1250		1SFN165503R9215		1.655
AF1350		1SFN165503R9216		2.475
AF1350T		1SFN165503R9217		2.475
AF1650		1SFN165503R9218		2.475
AF1650T		1SFN165503R9219		2.475
AF2050		1SFN165503R9220		2.475
AF2050T		1SFN165503R9221		2.475
AF2650		1SFN165503R9222		2.475
AF2650T		1SFN165503R9223		2.475

# Spare parts contactors

## Active products

### Spare part bottom

#### Ordering details

For contactor type	Type	Order code	Pkg qty	Weight (1 pce) kg
A145	Incl. terminal bars	1SFN165503R9231		1.310
A185	Incl. terminal bars	1SFN165503R9233		1.310
A210	Incl. terminal bars	1SFN165503R9235		1.960
A260	Incl. terminal bars	1SFN165503R9237		1.960
A300	Incl. terminal bars	1SFN165503R9239		1.960
AF145	Incl. terminal bars	1SFN165503R9232		1.310
AF185	Incl. terminal bars	1SFN165503R9234		1.310
AF210	Incl. terminal bars	1SFN165503R9236		1.960
AF260	Incl. terminal bars	1SFN165503R9238		1.960
AF300	Incl. terminal bars	1SFN165503R9240		1.960
AF400	Incl. terminal bars	1SFN165503R9241		4.635
AF460	Incl. terminal bars	1SFN165503R9241		4.635
AF580	Incl. terminal bars	1SFN165503R9243		5.135
AF750	Incl. terminal bars	1SFN165503R9243		5.135
AF1250	Incl. terminal bars and fixed contacts	1SFN165503R9245		6.215
AF1350	Incl. terminal bars and fixed contacts	1SFN165503R9246		18.060
AF1350 (1)		1SFN165503R9250		15.700
AF1650	Incl. terminal bars and fixed contacts	1SFN165503R9246		18.060
AF1650 (1)		1SFN165503R9251		15.700
AF2050	Incl. terminal bars and fixed contacts	1SFN165503R9248		18.305
AF2050 (1)		1SFN165503R9252		15.700
AF2650 (2)	Base part (plastic)	1SFN165503R9249		9.300

(1) From contactor serial number 1S160100514030001

(2) No terminal bars or fixed contacts included.



AFKIT

### Service kit

#### Description

This kit contains various parts as rubber bearings, springs, levers, plastic armatures, cable holders, screws.

#### Ordering details

For contactor type	Type	Order code	Pkg qty	Weight (1 pce) kg
AF1350 .... AF2050 (1)	AFKIT	1SFN165503R9253	1	0.200

(1) Until serial no. 1S16100514029999



AFBRG

### Contactor bridge

#### Description

Includes 3 contactor bridges and 6 springs.

#### Ordering details

For contactor type	Type	Order code	Pkg qty	Weight (1 pce) kg
AF1350 .... AF2050	AFBRG	1SFN165503R9254	1	1.000

# Spare parts contactors

## Classic products

1

### 3-pole contactors type EH

#### Ordering details

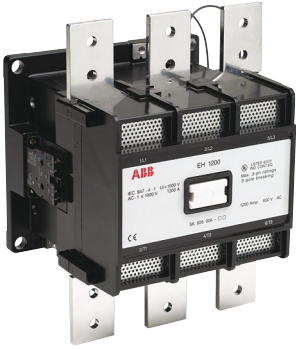

EH1200

Type code	Type	Order code	Pkg qty	Weight (1 pce) kg
EH175-30-11	EH175	SK825401-□□		4.700
EH175-30-21	EH175	SK825401-E□		4.700
EH175-30-22	EH175	SK825411-□□		4.700
EH210-30-11	EH210	SK825402-□□		4.700
EH210-30-21	EH210	SK825402-□□		4.700
EH210-30-22	EH210	SK825412-E□		4.700
EH260-30-11	EH260	SK826402-□□		6.200
EH260-30-21	EH260	SK826402-E□		6.200
EH260-30-22	EH260	SK826412-□□		6.200
EH300-30-11	EH300	SK826401-□□		6.250
EH300-30-21	EH300	SK826401-E□		6.250
EH300-30-22	EH300	SK826411-□□		6.250
EH370-30-11	EH370	SK827004-□□		12.400
EH370-30-22	EH370	SK827030-□□		12.400
EH550-30-11	EH550	SK827005-□□		12.400
EH550-30-22	EH550	SK827031-□□		12.400
EH700-30-11	EH700	SK828004-□□		17.100
EH700-30-22	EH700	SK828030-□□		17.100
EH800-30-11	EH800	SK828005-□□		17.300
EH800-30-22	EH800	SK828031-□□		17.300
EH1200-30-11	EH1200	SK828006-□□		18.000
EH1200-30-22	EH1200	SK828032-□□		18.000

### Drive contactors type EHDB

#### Ordering details



EHDB960

Type code	Type	Order code	Pkg qty	Weight (1 pce) kg
<b>2-pole contactors (2NO)</b>				
EHDB220-20-11	EHDB220	SK825484-□□		4.000
EHDB280-20-11	EHDB280	SK825486-□□		4.000
EHDB360-20-11	EHDB360	SK826484-□□		5.700
EHDB520-20-11	EHDB520	SK827084-□□		12.100
EHDB650-20-11	EHDB650	SK827086-□□		12.100
EHDB800-20-11	EHDB800	SK828084-□□		16.800
EHDB960-20-11	EHDB960	SK828086-□□		17.000
<b>3-pole contactors (2NO + 1NC) 300 V DC dynamic braking</b>				
EHDB220-21-11	EHDB220	SK825485-□□		4.000
EHDB280-21-11	EHDB280	SK825487-□□		4.000
EHDB360-21-11	EHDB360	SK826485-□□		5.700
EHDB520-21-11	EHDB520	SK827085-□□		12.100
EHDB650-21-11	EHDB650	SK827087-□□		12.100
EHDB800-21-11	EHDB800	SK828085-□□		16.800
EHDB960-21-11	EHDB960	SK828087-□□		17.000

Note: refer to page 1/17 for contactors order codes details.

# Spare parts contactors

## Classic products

### Main contact sets

#### Ordering details

For contactor type	Type	Order code	Pkg qty	Weight (1 pce) kg
--------------------	------	------------	---------	----------------------

#### Main contact sets for 3-pole contactors type EH

EH175	KZ175	SK825200-B	1 set	0.500
EH210	KZ210	SK825200-A	1 set	0.500
EH260	KZ260	SK826200-B	1 set	0.600
EH300	KZ300	SK826200-A	1 set	0.600
EH370	KZ370	SK827200-D	1 set	1.800
EH550	KZ550	SK827200-C	1 set	1.800
EH700	KZ700	SK828200-D	1 set	2.000
EH800	KZ800	SK828200-C	1 set	2.000
EH1200	KZ1200	SK828200-E	1 set	

#### Main contact sets for single pole NC contactors type EHDB

EHDB220	KZD220NC	SK825202-A	1 set	
EHDB280	KZD280NC	SK825202-B	1 set	
EHDB360	KZD360NC	SK826202-A	1 set	
EHDB520	KZD520NC	SK827202-A	1 set	
EHDB650	KZD650NC	SK827202-B	1 set	
EHDB800	KZD800NC	SK828202-A	1 set	
EHDB960	KZD960NC	SK828202-B	1 set	

#### Main contact sets for 2-pole NO contactors type EHDB

EHDB220	KZD220NO	SK825203-A	1 set	
EHDB280	KZD280NO	SK825203-B	1 set	
EHDB360	KZD360NO	SK826203-A	1 set	
EHDB520	KZD520NO	SK827203-A	1 set	
EHDB650	KZD650NO	SK827203-B	1 set	
EHDB800	KZD800NO	SK828203-A	1 set	
EHDB960	KZD960NO	SK828203-B	1 set	

#### Main contact sets for 4-pole contactors type EK

EK110	KZK110	SK824204-A	1 set	0.450
EK150	KZK150	SK824204-B	1 set	0.450
EK175	KZK175	SK825204-A	1 set	0.700
EK210	KZK210	SK825204-B	1 set	0.700
EK370	KZK370	SK827204-A	1 set	2.400
EK550	KZK550	SK827204-B	1 set	2.400
EK1000	KZK1000	SK827204-F	1 set	



KZK370

# Spare parts contactors

## Classic products

1

### Connection sets

#### Ordering details

For contactor type	Type	Order code	Pkg qty	Weight (1 pce) kg
--------------------	------	------------	---------	----------------------

#### Connection for reversing contactors

EH175, EH210	BSH210	SK829091-D		1.100
EH260, EH300	BSH300	SK829091-E		2.500
EH370, EH550	BSH550	SK829091-F		5.600
EH700	BSH700	SK829091-G		6.400
EH800	BSH800	SK829091-H		6.400
EH1200				

#### Connection for 4-pole chageover contactors

EK110	BSS100	SK829090-B		0.400
EK150	BSS145	SK829090-F		0.700
EK175, EK210	BSS210	SK829090-G		1.000
EK370, EK550	BSS550	SK829090-E		3.600
EK1000	BSS1000	SK829090-H		5.500

#### Connection for 4-pole start-delta starters

EH145 > A110	BED145	SK820092-L		0.700
EH175 > EH145	BSD210	SK829092-E		1.200
EH210 > EH175				
EH300 > EH210	BSD300	SK829092-F		2.000
EH370 > EH260	BSD550	SK829092-G		4.800
EH550 > EH300				
EH700 > EH550	BSD700	SK829092-H		6.600
EH800 > EH550	BSD800	SK829092-K		6.600

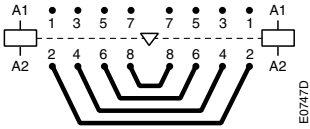

E07470

# Spare parts contactors

## Classic products

### Arc chute

#### Ordering details

For contactor type	Type	Order code	Pkg qty	Weight (1 pce) kg
--------------------	------	------------	---------	-------------------



KW800

#### Arc chute for 3-pole contactors type EH

EH175	KW175	5223351-AD		0.820
EH210	KW210	5223351-AE		0.820
EH300	KW300	5223351-AG		1.070
EH370	KW370	5223351-L		2.360
EH550	KW550	5223351-M		2.360
EH700	KW700	5223351-N		2.890
EH800	KW800	5223351-P		2.890
EH1200	KW1200	5223354-H		

#### Arc chute for 2-pole contactors type EHDB

EHDB220	KWD220-2P	5223353-B	1 set	
EHDB280	KWD280-2P	5223353-C	1 set	
EHDB360	KWD360-2P	5223353-D	1 set	
EHDB520	KWD520-2P	5223353-E	1 set	
EHDB650	KWP650-2P	5223353-F	1 set	
EHDB800	KWP800-2P	5223353-G	1 set	
EHDB960	KWP960-2P	5223353-H	1 set	

#### Arc chute for 3-pole contactors type EHDB

EHDB220	KWD220-3P	5223352-B	1 set	
EHDB280	KWD280-3P	5223352-C	1 set	
EHDB360	KWD360-3P	5223352-D	1 set	
EHDB520	KWD520-3P	5223352-E	1 set	
EHDB650	KWP650-3P	5223352-F	1 set	
EHDB800	KWP800-3P	5223352-G	1 set	
EHDB960	KWP960-3P	5223352-H	1 set	

#### Arc chute for 4-pole contactors type EK

EK110	KWK110	5223351-AH	1 set	0.660
EK150	KWK150	5223351-AK	1 set	0.660
EK175	KWK175	5223351-AL	1 set	1.260
EK210	KWK210	5223351-AM	1 set	1.260
EK370	KWK370	5223351-Y	1 set	3.170
EK550	KWK550	5223351-Z	1 set	3.170
EK1000	KWK1000	5223351-AN	1 set	3.170

# Spare parts contactors

## Classic products

1

### Terminal shrouds

#### Ordering details

Mounting on contactors	Type	Order code	Pkg qty	Weight (1 pce)
EH145 ... EH210	LT210-EL	SK178001-CB		0.060
EH145 ... EH210	LT210-EC	SK178003-CB		0.057
EH260, EH300	LT300-E	SK178001-DB		0.157
EH370, EH550	LT550-E	SK178001-EB		0.157
EH700	LT700-E	SK178001-FB		0.168
EH800	LT800-E	SK178001-GB		0.182
EK110, EK150	LT150-EK	SK178001-HB		0.182
EK175, EK210	LT210-EK	SK178001-KB		0.139
EK370, EK550	LT550-EK	SK178001-LB		0.190
EK1000	LT1000-EK	SK178001-MB		0.200

### Terminal extensions

#### Ordering details

Mounting on contactors	Dimensions		Type	Order code	Pkg qty	Weight (1 pce)
	hole Ø mm	bar mm				
EH145 ... EH210	11	20 x 5	LX210	SK879902-C		0.150
EH260 ... EH550	11	25 x 6	LX550	SK879902-D		0.300
EH700	11	40 x 6	LX700	SK879902-E		0.700

### Terminal enlargements

#### Ordering details

Mounting on contactors	Dimensions		Type	Order code	Pkg qty	Weight (1 pce)
	hole Ø mm	bar mm				
EH145 ... 210	11	20 x 5	LW210	SK879901-C		0.300

### Terminal connecting strips

#### Ordering details

For contactor	Type	Order code	Pkg qty	Weight (1 pce)
EH210 EH210	LY210	26310243-6		0.100
EH260 EH300	LY300	26310243-4		0.200
EH370 EH500	LY550	26310243-5		0.250



# Spare parts contactors

## Classic products

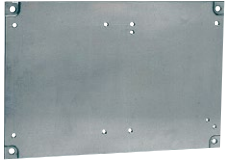

PN ...

1SBC565663F0302

### Mounting plates

#### Ordering details

To use with left hand contactor	Mecha	Right hand contactor	Type	Order code	Pkg qty	Weight (1 pce) kg
---------------------------------	-------	----------------------	------	------------	---------	-------------------

#### Plates for two horizontal mounted contactors with or without a mechanical interlock unit and/or thermal overload relay

EH175, EH210	VH250A	EH145	PN210-22	SK829075-C		1.400
EH175, EH210	VH300	EH175, EH210				
EK110, EK150	VH45	EK175, EK210				
EH260, EH300	VH300	EH175, EH210	PN300-22	SK829075-E		2.070
EH260, EH300	VH300	EH260, EH300				
EK175, EK210	VH300	EK175, EK210				

#### Plates for two horizontal mounted contactors with or without a mechanical interlock unit and/or thermal overload relay

EH370, EH550	-	EH370, EH550	PN550-21	21750297-5		4.100
EH700, EH800	-	EH700, EH800	PN800-22	21750297-6		5.000
EH370, EH550	-	EH370, EH550				

### Main dimensions mm

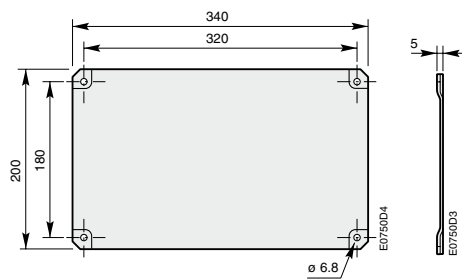

PN210-22

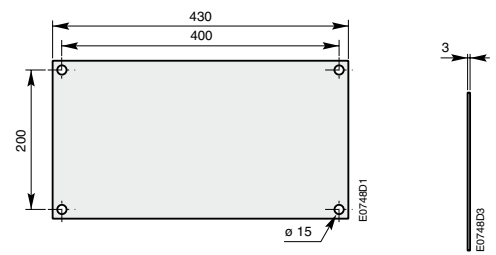

PN300-22

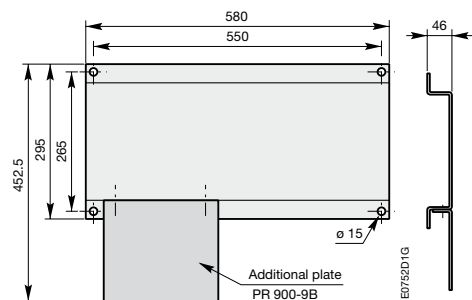

PN550-22

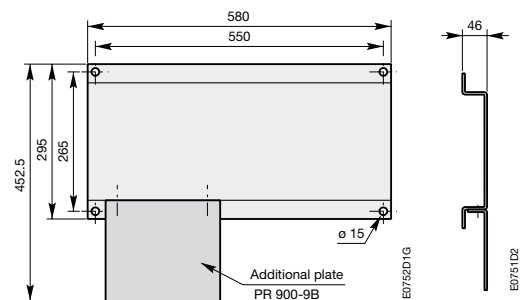

PN800-22

# Spare parts contactors

## Classic products

1



1SFN96001-016C3

PR300-1

## Adapter plates

### Description

Adapter plates with fixing holes for specified old contactors to new contactors.

### Ordering details

From old contactor	To new contactor	Type	Order code	Pkg qty	Weight (1 pce) kg
EH65, EH75, EH80, EH90, EG80	A95, A110	PR110-1	1SFN094500R1000	1	0.270
EH100, EH145	A110, A145	PR145-1	1SFN094700R1000	1	0.360
EH150, EH160, EH175, EH210, EG160	A185, A210	PR210-1	1SFN094900R1000	1	0.440
EH250, EH260, EH300	A210...A300	PR300-1	1SFN095300R1000	1	0.560
EH370, EH550, EG315	AF400...AF580	PR460-1	1SFN095700R1000	1	0.900
EH700, EH800	AF750	PR750-1	1SFN096100R1000	1	0.500
EH550, EG630	AF580, AF750	PR750-2	1SFN096100R1001	1	1.100

Note: The adapter plates provided for the A ... contactors can also be used for the AF ... contactors.

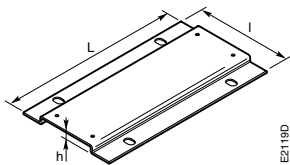

E2118D

### Dimensions (mm)

Type of the plate	Dimensions			Fixing holes
	L	l	h	mm
PR110-1	151	106	11.2	2 x $\varnothing$ 7
PR145-1	180	122	11.5	4 x $\varnothing$ 7
PR210-1	200	132	11.5	4 x $\varnothing$ 7
PR300-1	200	172	11.5	4 x $\varnothing$ 7
PR460-1	278	198	11.5	4 x $\varnothing$ 7
PR750-1	283	244	11.5	4 x $\varnothing$ 7

Note: The adapter plates provided for the A ... contactors can also be used for the AF ... contactors.

Fixing holes according to the plate types

# Spare parts contactors

## Classic products

### Mechanical and electrical interlocking units

#### Ordering details

For contactors		Type	Order code	Pkg qty	Weight (1 pce) kg
on left	on right				
<b>Mechanical interlock units of two horizontal mounted contactors</b>					
EH370, EH550	EH260 ... EH550	VH550	SK829070-E	1	5.000
EHDB520 ... EHDB650	EHDB520 ... EHDB650				
EH700, EH800	EH370 ... EH800	VH800	SK829070-F	1	6.000
EH370, EH550	EK370, EK550				
EHDB800, EHDB960	EHDB800, EHDB960				
EH145	EH145	VH145W	SK829070-B	1	2.300
EH175, EH210	EH175, EH210	VH210W	SK829070-C	1	2.400
EH260, EH300	EH260, EH300	VH300W	SK829070-D	1	2.800
<b>Mechanical and electrical interlock units of two horizontal mounted contactors</b>					
EH175, EH210	EK175, EK210	VH300	SK829071-B	1	0.130
EHDB220 ... EHDB360	EHDB220 ... EHDB360				
<b>Mechanical interlock units of two horizontal mounted contactors</b>					
EK370 ... EK1000	EK370 ... EK1000	VH800	SK829070-F		6.00
<b>Mechanical and electrical interlock units of two vertical mounted contactors</b>					
EK110, EK150	EK110, EK150	VKV150	SK829072-B		0.250
EH260, EH300	EH260, EH300	VHV300	SK829072-D		0.430
EK175, EK210	EK175, EK210				
EK175, EK210	EH145	VHV210A	SK829072-F		0.220
EH145	EH145	VHV145	SK829072-A		0.430
EK175, EK210	EH260, EH300	VHV210	SK829072-C		0.600

# Spare parts contactors

## Classic products

1



KH550...KH800

## Contactors coils

### Ordering details

For contactor type

	Type	Order code	Pkg qty	Weight (1 pce) kg
<b>AC or DC operated coils for EH and EK contactors</b>				
EH175, EH210	KH210	SK825400-□□		0.360
EK110, EK150				
EHDB220, EHDB280				
EH300	KH250	SK825100-□□		0.440
EH260, EH300	KH300	SK826400-□□		0.440
EK175, EK210				
EHDB360				
EK370, EK550	KH550	SK827100-□□		0.780
EHDB520, EHDB650				
EH700, EH800	KH800	SK828100-□□		0.950
EK370, EK550, EK1000				
EHDB800, EHDB960				
EH1200	KH1200	SK828101-□□		
<b>Sets including a DC coil, an economy resistor and an inertion contact</b>				
EH175, EH210	KP210	SK825450-□□		0.360
EK110, EK150				
EH260, EH300	KP300	SK826450-□□		0.440
EK175, EK210				
EH370, EH550	KP550	SK827150-□□		0.780
EH700 ... EH800	KP800	SK828150-□□		0.950
<b>Sets including a multi-frequency coil and an nsertion contact for contactor with built-in rectifier</b>				
EH175, EH210	KP210	SK825450-E □		0.300
EK110, EK150				
EH260, EH300	KP300	SK826450-E □		0.400
EK175, EK210				
<b>AC and DC operated coils for the mechanical latching units on EH145 ... EH800 contactors</b>				
D.C. operated	KX800X	SK829100-□□		0.090

# Spare parts contactors

## Classic products

### Coil codes contactor / coil type EH / KH ...

#### AC operated

Voltage		Contactor * / coil ** type									Coil code	
50 Hz	60Hz	EH175 / KH210	EH210 / KH210	EH260 / KH300	EH300 / KH300	EH370 / KH550	EH550 / KH550	EH700 / KH800	EH800 / KH800	EH1200 / KH1200	<input type="checkbox"/>	<input type="checkbox"/>
48		•	•	•	•	•	•	•	•	•		
	110	•	•	•	•	•	•	•	•	•		
110	120	•	•	•	•	•	•	•	•	•		
190	220	•	•	•	•	•	•	•	•	•		
	240	•	•	•	•	•	•	•	•	•		
220 ... 230		•	•	•	•	•	•	•	•	•		
230 ... 240		•	•	•	•	•	•	•	•	•		
	380	•	•	•	•	•	•	•	•	•		
380 ... 400	440	•	•	•	•	•	•	•	•	•		
400 ... 415		•	•	•	•	•	•	•	•	•		
	480	•	•	•	•	•	•	•	•	•		
660		•	-	-	-	-	-	•	•	-		

#### DC operated

Voltage		Contactor * / coil ** type									Coil code	
V DC		EH175 / KH210	EH210 / KH210	EH260 / KH300	EH300 / KH300	EH370 / KH550	EH550 / KH550	EH700 / KH800	EH800 / KH800	EH1200 / KH1200	<input type="checkbox"/>	<input type="checkbox"/>
24		•	•	•	•	•	•	•	•	•		
110		•	•	•	•	•	•	•	•	•		
125		•	•	•	•	•	•	•	•	-		
77 ... 143		-	-	•	-	-	-	-	-	-		

#### Multi frequency

Voltage		Contactor * / coil ** type									Coil code	
40 ... 400 Hz		EH175 / KH210	EH210 / KH210	EH260 / KH300	EH300 / KH300	EH370 / KH550	EH550 / KH550	EH700 / KH800	EH800 / KH800	EH1200 / KH1200	<input type="checkbox"/>	<input type="checkbox"/>
110 ... 120		-	-	-	•	-	•	•	-	•		
115 ... 127		•	-	-	-	-	•	-	•	-		
220 ... 230		-	•	-	•	•	•	•	•	•		
230 ... 240		•	•	•	•	•	•	•	•	-		
400 ... 415		-	-	-	-	•	•	-	-	-		

# Spare parts contactors

## Classic products

### 1 Coil codes contactor / coil type EK / KH ...

#### AC operated

Voltage		Contactor * / coil ** type							Coil code	
50 Hz	60Hz	EK110 / KH210	EK150 / KH210	EK175 / KH300	EK210 / KH300	EK370 / KH550	EK550 / KH550	EK1000 / KH800	<input type="checkbox"/>	<input type="checkbox"/>
48		•	•	•	•	•	•	•	A	D
	110	•	•	•	•	•	•	-	A	E
110	120	•	•	•	•	•	•	•	A	F
190	220	•	•	•	•	•	•	•	A	H
	240	•	•	•	•	•	•	-	A	K
220 ... 230	240	•	•	•	•	•	•	•	A	L
230 ... 240		•	•	•	•	•	•	•	A	M
	380	•	•	•	•	•	•	-	A	N
380 ... 400	440	•	•	•	•	•	•	•	A	P
400 ... 415		•	•	•	•	•	•	•	A	R
	380	•	•	•	•	•	•	•	A	S
	600	•	•	•	•	•	•	•	A	V
660		•	•	•	•	-	•	•	A	Y
	208	•	•	•	•	•	•	-	A	Z
250		•	-	-	-	-	•	•	B	B

#### DC operated

Voltage		Contactor * / coil ** type							Coil code	
V d.c.		EK110 / KH210	EK150 / KH210	EK175 / KH300	EK210 / KH300	EK370 / KH550	EK550 / KH550	EK1000 / KH800	<input type="checkbox"/>	<input type="checkbox"/>
24		•	•	•	•	•	•	•	D	B
48		•	•	•	•	•	•	•	D	D
110		•	•	•	•	•	•	•	D	E
220		•	•	•	•	•	•	•	D	E
125		•	•	•	•	•	•	-	D	U
77 ... 143		•	•	•	•	•	•	-	W	R
90 ... 190		•	-	-	-	•	-	-	W	U

#### Multi frequency

Voltage		Contactor * / coil ** type							Coil code	
40 ... 400 Hz		EK110 / KH210	EK150 / KH210	EK175 / KH300	EK210 / KH300	EK370 / KH550	EK550 / KH550	EK1000 / KH800	<input type="checkbox"/>	<input type="checkbox"/>
110 ... 120		•	•	•	•	•	•	•	E	F
115 ... 127		•	•	•	•	•	•	•	E	G
220 ... 230		•	•	•	•	•	•	•	E	L
230 ... 240		•	•	•	•	•	•	•	E	M
400 ... 415		•	•	•	•	•	•	-	E	R

### Coil codes contactor / coil type EHDB / KH ...

#### AC operated

Voltage		Contactor * / coil ** type							Coil code	
50 Hz	60Hz	EHDB220 / KH210	EHDB280 / KH210	EHDB360 / KH300	EHDB520 / KH550	EHDB650 / KH550	EHDB800 / KH800	EHDB960 / KH800	<input type="checkbox"/>	<input type="checkbox"/>
	110	•	-	-	-	-	-	-	A	E
110		•	•	•	•	•	•	•	A	F
190		-	-	-	-	-	-	-	A	H
	240	•	•	•	•	•	•	•	A	K
230		•	•	•	•	•	•	-	A	L
230 ... 240		•	•	•	-	-	-	-	A	M
400 ... 415		•	•	•	•	•	•	•	A	R
	600	•	-	-	-	-	-	-	A	V
	208	•	•	•	-	-	-	-	A	Z
110 ... 115		•	•	•	-	-	-	-	G	G

Note: GG includes surgesupressor

#### DC operated

Voltage		Contactor * / coil ** type							Coil code	
V d.c.		EHDB220 / KH210	EHDB280 / KH210	EHDB360 / KH300	EHDB520 / KH550	EHDB650 / KH550	EHDB800 / KH800	EHDB960 / KH800	<input type="checkbox"/>	<input type="checkbox"/>
24		•	-	-	•	-	-	-	D	B
220		•	-	-	-	-	-	-	D	F
125		•	-	-	-	-	-	-	D	U
110		•	•	•	•	-	-	-	D	E
110		•	•	•	-	-	-	-	R	E

# Spare parts contactors

## Classic products

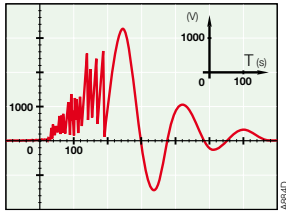

## Surge suppressors for contactor coils

### Description

The operation of inductive circuits causes overvoltages, in particular on opening of the contactor coil.

The electromagnetic energy stored in the coil during contactor closing is restored on opening in the form of surges, the slope and amplitude of which may rise to several kilovolts. A number of drawbacks are observed ranging from interference on the electronic devices to breakdown of insulators and even destruction of certain sensitive components.

The graph opposite reproduces the oscillogram showing voltage discharges at the terminals of a 42 V / 50 Hz coil without peak clipping. The coil was switched by 8 series-connected poles of a contactor relay.

Following a burst of discharges with a very steep slope a damped oscillation emerges with a peak value of 3500 V.

### Overvoltage Factor

The overvoltage factor  $k$  is defined as the ratio of the maximum overvoltage peak value  $\hat{U}_s$  to the peak value  $\hat{U}_c$  of the coil rated control voltage  $U_c$ :

$$k = \frac{\hat{U}_s \text{ max.}}{\hat{U}_c} \quad \text{in DC: } k = \frac{\hat{U}_s \text{ max.}}{U_c} \quad \text{or in AC: } k = \frac{\hat{U}_s \text{ max.}}{U_c \sqrt{2}}$$

For example the following is obtained for the above graph:  $k = \frac{3500}{42 \sqrt{2}} \approx 60$

To reduce the harmful effects of these overvoltages, ABB has developed a range of surge suppressors designed to reduce the  $k$  factor defined above and to limit or even completely eliminate the high pre-damping voltage frequencies.

Each case is different, but the technical data tolerances and the generous sizing of parts have enabled us to reduce the number of variants.

We have chosen the following solutions: transil diodes, varistors and RC blocks.

Note: A varistor is a resistor whose value decreases to a very large extent when a certain voltage is applied at its terminals.

### Ordering details

For contactors	Rated control circuit voltage $U_c$		Type	Order code	Pkg qty	Weight (1 pce) kg
	V	AC DC				
EH175 ... EH300, EK100 ... EK210	24...48	● -	RC-EH300/48	SK829007-A	2	0.015
	110...415	● -	RC-EH300/416	SK829007-B		
EHDB130 ... EHDB360	110...415	- ●	RC-EH300/415	SK829007-B	2	0.015
EH370 ... EH800, EK370 ... EK550	48...100	● -	RC-EH800/110	SK829007-C		
EHDB520 ... EHDB960		- ●			2	0.015
EH175 ... EH800, EK110 ... EK550	24...125	- ●				
EH370 ... EH800, EK370 ... EK1000	220...600	● -	RC-EH800/600	SK829007-D	2	0.015
EHDB520 ... EHDB960		- ●				

# Spare parts contactors

## Classic products

1

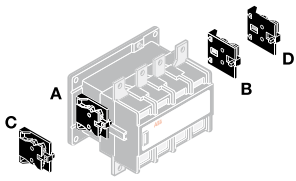

Mounting positions of the CAL16-11

E20740

### Auxiliary contact blocks

#### Description

The auxiliary contact blocks are used for the operation of auxiliary circuits and control circuits.





Types of auxiliary contact blocks for standard industrial environments:

- CAL instantaneous with N.O. + N.C. contacts
- CCL N.O. leading contact + N.C. lagging contact.

The auxiliary contact blocks are equipped with screw type connecting terminals delivered open, protected against accidental direct contact, and bear the corresponding function marking.

Mounting: Screwed onto the right and / or lefthand side of the EK110 ... EK1000 contactors.

#### Ordering details

For contactors	Number of blocks	Auxiliary contacts	Type	Order code	Pkg qty	Weight (1 pce)
		   				kg
EH, EK, EHDB	1	1 1 - -	CAL16-11A	SK829002-A	1	0.050
EH, EK, EHDB	1	1 1 - -	CAL16-11B	SK829002-B	1	0.050
EH, EK, EHDB	1	1 1 - -	CAL16-11C	SK829002-C	1	0.050
EH, EK, EHDB	1	1 1 - -	CAL16-11D	SK829002-D	1	0.050
EH, EK	1	1 - - 1	CCL16-11E (1)	SK829002-E	1	0.050

(1) Mounting of CCL16-11E blocks does not allow an additional second block to be added on top of it.  
All DC operated EK... contactors are equipped with one CCL16-11E on the right side.



# Spare parts R contactors

## Main poles

Contact sets	2/2
Arcing horns	2/2
Equipotential connections	2/3
Arc chutes	2/3

## Control circuits

Surge suppressors	2/4
Rectifiers	2/4
Magnet circuits	2/4

## Auxiliary contact

Auxiliary contact CA12	2/5
Auxiliary contacts CA15	2/5
Mounting kits	2/5

# Spare parts R contactors

## Main poles

2

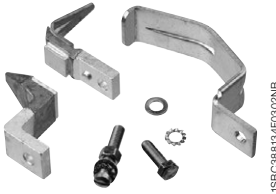

1SBC385134FC02NB

### Contact sets for N.O. or N.C. main poles

#### Description

The contact sets include 1 fixed contact, 1 moving contact, 1 arcing horn (according to table below) and screws.

The quantities needed are defined per ratings as follow:

- 1 set per pole for R63...R800, R1000, R1400, R1700, R2100
- 2 sets per pole for R1250, R1500, R2500, R3200, R3800
- 3 sets per pole for R2000, R4500, R5100
- 4 sets per pole for R3150
- 5 sets per pole for R4000.

#### Ordering details

For R contactors type		Order code	Pkg qty	Weight (1 pce) kg
<b>Contact set with arcing horn</b>				
IOR, NOR, JOR, FOR	63, 85	FPTN410389R0001	1 set	0.050
	125, 170	FPTN410389R0002	1 set	0.150
	200, 260	FPTN410389R0003	1 set	0.250
	315, 400 (1), 420	FPTN410389R0004	1 set	0.400
	400 (2), 500, 550, 630	FPTN410389R0005	1 set	0.480
<b>Contact set without arcing horn</b>				
LOR	85	FPTN410390R0001	1 set	0.040
	170	FPTN410390R0002	1 set	0.090
	260	FPTN410390R0003	1 set	0.180
	420	FPTN410390R0004	1 set	0.250
	400, 550	FPTN410390R0005	1 set	0.470
IOR, NOR, JOR, FOR, LOR	800, 1000, 1250, 1500, 2000, 3150, 4000	FPTN410391R0001	1 set	0.520
	1400, 2500	FPTN410503R0001	1 set	0.520
	1700, 2100, 3800, 4500, 5100	FPTN410506R0001	1 set	0.830

(1) For NOR and JOR types, N.C. poles

(2) For IOR, NOR, JOR types, N.O. poles



1SBC104038F0014

### Arcing horns for N.O or N.C. main poles

#### Ordering details

For R contactors type IOR, NOR, JOR, FOR	Order code	Pkg qty	Weight (1 pce) kg
800, 1000, 1250, 1500, 2000, 3150, 4000	FPTN410446R0001	1	0.200
1400, 2500	FPTN410446R0001	1	0.200
1700, 2100, 3200, 3800, 4500, 5100	FPTN410508R0001	1	0.280

# Spare parts R contactors

## Main poles



18SC04032F0014

### Equipotential connections

#### Description

Equipotential connections must be ordered separately for ratings  $\geq 800$  A.

#### Ordering details

For R contactors type IOR, NOR, JOR and FOR	Type	Order code	Pkg qty	Weight (1 pce) kg
800 ... 5100	NO poles	FPTN410176R0006		0.500
800 ... 4000	NC poles	FPTN410176R0007		0.530

2

### Arc chutes

#### Description

De-ion arc chutes replace basic arc chutes except for 315 and 420 A ratings.

#### Ordering details

For R contactors type IOR, NOR, JOR and FOR	Type	Order code	Pkg qty	Weight (1 pce) kg
63, 85	De-ion arc chute	FPTN401938R0002		0.470
125, 170	De-ion arc chute	FPTN401939R0002		0.930
200, 260	De-ion arc chute	FPTN401940R0002		1.360
315, 400 (1), 420	Basic arc chute	FPTN401936R0002		1.300
400 (2), 500, 550	De-ion arc chute	FPTN401941R0002		3.600
800, 1000, 1250, 1500, 2000, 3150, 4000	De-ion arc chute	FPTN410067R0002		2.570
1400, 2500	De-ion arc chute	FPTN410067R0002		2.570
1700, 2100, 3200, 3800, 4500, 5100	De-ion arc chute	FPTN410507R0001		3.150

(1) For NOR and JOR types, N.C. poles

(2) For IOR, NOR, JOR types, N.O. poles

18SC357943F0002

### Pressure springs, insulated supports, complete poles and other spare parts

Please contact your local sales organisation (order code for R contactor needed).

# Spare parts R contactors

## Control circuits

2



1SECI04030F0014

### Surge suppressors for contactor coils

#### Ordering details

For R contactors type IOR, NOR, JOR, LOR and FOR	Rated control circuit voltage Uc		Type	Order code	Pkg qty	Weight (1 pce) kg
	V	AC DC				
63 ... 5100	24...60	● -	RV-R1/60	FPTN410463R6001	1	0.050
	60...133	● -	RV-R1/133	FPTN410463R6002	1	0.050
	110...250	● -	RV-R1/250	FPTN410463R6003	1	0.050
	250...440	● -	RV-R1/440	FPTN410463R6004	1	0.050
	440...660	● -	RV-R1/660	FPTN410463R6005	1	0.050
	24...90	- ●	RV-R1/60	FPTN410463R6001	1	0.050
	60...180	- ●	RV-R1/133	FPTN410463R6002	1	0.050
	110...320	- ●	RV-R1/250	FPTN410463R6003	1	0.050
	250...550	- ●	RV-R1/440	FPTN410463R6004	1	0.050
	440...660	- ●	RV-R1/660	FPTN410463R6005	1	0.050



1SECI04028F0014

### Rectifiers

#### Ordering details

For R contactors type IORR, NORR, JORR, LORR and FORR	Rated control circuit voltage Uc	Order code	Pkg qty	Weight (1 pce) kg
63 ... 5100	< 440 V AC	TRE2614501	1	0.050
	≥ 440 V AC	TRE2720801	1	0.050

### Complete control circuit kit

Including:

- 1 coil
- 1 economy resistor
- 1 surge suppressor
- 1 rectifier

For complete kit, please contact your local sales organization (order code of R contactor needed).

### Magnet circuits

#### Ordering details

For R contactors type IORR, NORR, JORR, LORR, and FORR IORE, NORE, JORE, LORE, and FORE	Order code	Pkg qty	Weight (1 pce) kg
63, 85	FPTN410437R0001	1	1.500
125, 170	FPTN410438R0001	1	1.500
200, 260	FPTN410439R0001	1	1.500
400 ... 630	FPTN410441R0001	1	2.500
≥ 800	FPTN410200R0001	1	8.000

For tripping electro-magnet circuit AME or AM(F)-CC > 800 A: use 63, 85 A electro-magnet circuit.

For IOR and IOR ... AMA versions, please consult your local sales organization (order code of R contactor needed).

### Coils, economy resistors and other specific parts

Please contact your local sales organization (order code of R contactor needed).

# Spare parts R contactors

## Auxiliary contacts



CA12

### Auxiliary contact blocks type CA12

#### Description



CA12 auxiliary contact blocks 2 or 4-pole are mounted on a support bracket, above the electro-magnet.

The R contactors type R and RE can be equipped with:

- 1 or 2 x 2-pole blocks
- 1 x 2-pole block + 1 x 4-pole blocks.

The R contactors type RR can be equipped with 1 or 2 x 2-pole blocks.

#### Ordering details



For R contactors type R, RE, RR (RC excluded)	Auxiliary contacts	Type	Order code	Pkg qty	Weight (1 pce) kg
	 				
<b>Auxiliary contact blocks</b>					
63...550	1 1	CA12-1	FPTN410004R0001	1	0.050
	2 0	CA12-2	FPTN410005R0001	1	0.050
	2 2	CA12-11	FPTN410013R0001	1	0.090
	1 3	CA12-12	FPTN410016R0001	1	0.090
	4 0	CA12-22	FPTN410012R0001	1	0.090
<b>Support bracket</b>					
63 ... 260		Support bracket	FPTN410056R0001	1	0.060
315 ... 550		Support bracket	FPTN410056R0002	1	0.060

### Auxiliary contacts type CA15

#### Description

CA15 auxiliary contacts are mounted on a mounting kit, on the frame.

#### Ordering details

For R contactors type R, RE, RR, RC	Auxiliary contacts	Type	Order code	Pkg qty	Weight (1 pce) kg
	 				
<b>Auxiliary contact with screw terminals</b>					
63 ... 5100	1 0	CA15-F	FPTN410008R0004	1	0.070
	0 1	CA15-O	FPTN410007R0006	1	0.070
<b>Auxiliary contact for railway</b>					
63 ... 5100	1 0	CA15-F	FPTN210382R0003	1	0.070
	0 1	CA15-O	FPTN210382R0004	1	0.070
<b>Mounting kit</b>					
63 ... 170, 315...550, auxiliary frame ≥ 800		Universal mounting kit	FPTN410054R0016	1	On request
200 ... 260		Mounting kit	FPTN410054R0017	1	
Main frame ≥ 800		Mounting kit	FPTN410213R0006	1	



CA15-F



CA15-O

### Special auxiliary contact blocks

Please contact your local sales organization (order code of R contactor needed).



# Spare parts softstarters type PSE, PSS, PST, PSTB and PSTX

HMI module	3/2
HMI spare kit	3/2
Printed circuit board	3/2
Cooling fan	3/2
Upper bar holders including terminals	3/3
Lower bar holders including terminals	3/3
Stays	3/3
Bypass relay and contactor	3/4
USB-cable for SoftstarterCare	3/4
Display	3/4
Keypad	3/4
PST(B) cover	3/4
SCR, PSE	3/5
SCR, PSS	3/5
SCR, PST and PSTX	3/6
SCR, PSTB	3/7
SCR clamp upgrade kit	3/7
Kit for changing SCR	3/7
For softstarters type PSS, PST and PSTB	3/8
Holders	3/8
For softstarters type PSS, PST and PSTB	3/9

# Spare parts softstarters



PSHMI-1,2



PSEHMI-1, 2, 3



PSPCB-HV



PSPCB-LV



PSPCB-CB



PSFA

## HMI-module

### Ordering details

For softstarter type	Pcs/ unit	Type	Order code	Pkg qty	Weight (1 pce) kg
PSE18 ... PSE105	1	PSEHMI-1	1SFA899219R7001	1	0.560
PSE142 ... PSE170	1	PSEHMI-2	1SFA899219R7002	1	0.560
PSE210 ... PSE370	1	PSEHMI-3	1SFA899219R7003	1	0.560
PST30 ... PST300	1	PSHMI-1	1SFA899019R7001	1	1.000
PSTB370 ... PSTB1050	1	PSHMI-2	1SFA899019R7002	1	1.000
PST30-T ... PST300-T	1	PSHMI-1-T	1SFA899019R7021	1	1.000
PSTB370-T ... PSTB1050-T	1	PSHMI-2-T	1SFA899019R7022	1	1.000
PSTX30 ... PSTX1250	1	PSDKP-1	1SFA899319R1001	1	0.325

## HMI spare kit

### Ordering details

For softstarter type	Pcs/ unit	Type	Order code	Pkg qty	Weight (1 pce) kg
PSTX30...PSTX1250	1	PSACC-1	1SFA899320R1001	1	0.136

## Printed circuit board

### Ordering details

For softstarter type		Type	Order code	Pkg qty	Weight (1 pce) kg
PSS18 ... PSS300 <sup>1)</sup>	Main PCB230 ... 500 V	PSPCB-500/S	1SFA899020R1500	1	0.370
PSS18...PSS300-C <sup>2)</sup>	Main PCB230 ... 500 V	PSPCB-500C/S	1SFA899020R2500	1	0.370
PSS18 ... PSS300 <sup>1)</sup>	Main PCB380 ... 690 V	PSPCB-690/S	1SFA899020R1690	1	0.470
PSS18...PSS300-C <sup>2)</sup>	Main PCB380 ... 690 V	PSPCB-690C/S	1SFA899020R2690	1	0.470
PST30 ... PST300	LV board	PSPCB-LV/T	1SFA899020R7000	1	0.360
PSTB370 ... PSTB1050					
PST30-T ... PST300-T	LV board	PSPCB-LV/T-T	1SFA899020R7020	1	0.360
PSTB370-T ... PSTB1050-T					
PST30 ... PST300	HV board	PSPCB-690/T	1SFA899020R7690	1	0.190
PSTB370 ... PSTB1050					
PST30-T ... PST300-T	HV board	PSPCB-690/T-T	1SFA899020R7691	1	0.190
PSTB370-T ... PSTB1050-T					
PSTX30...PSTX170	Control board 1	PSPCB-CB-1	1SFA899301R1007	1	0.650
PSTX210...PSTX370	Control board 2	PSPCB-CB-2	1SFA899301R1008	1	0.660
PSTX470...PSTX1250	Control board 3	PSPCB-CB-3	1SFA899301R1009	1	0.670

1) Printed circuit board with fault signal contact normally open (N.O.)  
2) Printed circuit board with fault signal contact normally closed (N.C.)

## Cooling fan

### Ordering details

For softstarter type	Main Voltage	Pcs/ unit	Type	Order code	Pkg qty	Weight (1 pce) kg
PSE18 ... PSE105		2	PSFA-40	1SFA899215R1040	1	0.025
PSE142 ... PSE170		2	PSFA-60	1SFA899215R1060	1	0.055
PSE210 ... PSE370		2	PSFA-80	1SFA899215R1080	1	0.070
PSS18 ... PSS44	500 V	1	PSFA-12	1SFA899015R1012	1	0.020
PSS50 ... PSS72	500 V	2	PSFA-12	1SFA899015R1012	1	0.020
PSS18 ... PSS44	690 V	2	PSFA-12	1SFA899015R1012	1	0.020
PSS85 ... PSS142	500/690 V	2	PSFA-115	1SFA899015R1115	1	0.250
PSS175 ... PSS300	500/690 V	4	PSFA-115	1SFA899015R1115	1	0.250
PST30 ... PST72	500/690 V	2	PSFA-024	1SFA899015R7024	1	0.020
PST85 ... PST142	500/690 V	2	PSFA-224	1SFA899015R7224	1	0.020
PST175 ... PST300	500/690 V	4	PSFA-224	1SFA899015R7224	1	0.020
PSTB370... PSTB1050	500/690 V	3	PSFA-224	1SFA899015R7224	1	0.020



# Spare parts softstarters



PSBH-1, 2, PSTBH-1, 2

## Upper barholders including terminals

### Ordering details

For softstarter type	Pcs/ unit	Type	Order code	Pkg qty	Weight (1 pce) kg
PSS85 ... PSS142	1	PSBH-1	1SFA899030R1001	1	0.300
PSS175 ... PSS300	1	PSBH-2	1SFA899030R1002	1	0.700
PST85 ... PST142	1	PSTBH-1	1SFA899031R1001	1	0.700
PST175 ... PST300	1	PSTBH-2	1SFA899031R1002	1	1.130
PSTB370 ... PSTB470 *	1	PSTBH-3	1SFA899031R1003	1	1.000
PSTB570... PSTB1050 *	1	PSTBH-4	1SFA899031R1004	1	1.200

\* No terminal included



PSBH-1, 2, PSTBH-1, 2

## Lower barholders including terminals

### Ordering details

For softstarter type	Pcs/ unit	Type	Order code	Pkg qty	Weight (1 pce) kg
PSS85 ... PSS142	1	PSBH-1	1SFA899030R1001	1	0.500
PSS175 ... PSS300	1	PSBH-2	1SFA899030R1002	1	0.700
PST85 ... PST142	1	PSBH-1	1SFA899030R1001	1	0.500
PST175 ... PST300	1	PSBH-2	1SFA899030R1002	1	0.700
PSTB370 ... PSTB470 *	1	PSTBH-3	1SFA899031R1003	1	1.000
PSTB570 ... PSTB1050 *	1	PSTBH-4	1SFA899031R1004	1	1.200

\* No terminal included



PSTLS, RS, MS

## Stays

### Ordering details

For softstarter type	Pcs/ unit	Type	Order code	Pkg qty	Weight (1 pce) kg
PSTB370 ... PSTB470	1	PSTLS-1	1SFA899032R1001	1	0.200
	1	PSTRS-1	1SFA899032R1002	1	0.200
	1	PSTMS-1	1SFA899032R1003	1	0.200
PSTB570 ... PSTB1050	1	PSTLS-2	1SFA899032R1004	1	0.300
	1	PSTRS-2	1SFA899032R1005	1	0.300
	1	PSTMS-2	1SFA899032R1006	1	0.300

# Spare parts softstarters

3



PSBP

## Bypass relay and contactor

### Ordering details

For softstarter type	Pcs/unit	Type	Order code	Pkg qty	Weight (1 pce) kg
PSE18 ... PSE105	2	PSBP-120	1SFA899201R1120	2	0.170
PSE142 ... PSE170	1	PSBP-200	1SFA899201R1200	1	0.330
PSE210 ... PSE370	2	AF110-30-00	1SFL457001R7000	1	2.100

## USB-cable for SoftstarterCare

### Ordering details



PSECA

For softstarter type	Pcs/unit	Type	Order code	Pkg qty	Weight (1 pce) kg
PSE18 ... PSE370	1	PSECA	1SFA897201R1001	1	0.130

## Display

### Ordering details



PSDP-1

For softstarter type	Pcs/unit	Type	Order code	Pkg qty	Weight (1 pce) kg
PST30 .. PST300 PSTB370 ... PSTB1050	1	PSDP-1	1SFA899017R1000	1	0.040

## Keypad

### Ordering details

For softstarter type	Pcs/unit	Type	Order code	Pkg qty	Weight (1 pce) kg
PST30 .. PST300 PSTB370 ... PSTB1050	1	PSKP-1	1SFA899018R1000	1	0.010

## PST(B) cover

### Ordering details



PSTC-1

For softstarter type	Pcs/unit	Type	Order code	Pkg qty	Weight (1 pce) kg
PST(B)	1	PSTC-1	1SFA899040R1001	1	0.136

Softstarter type code needs to be included with the order in the special handling text.

# Spare parts softstarters

## SCR <sup>1)</sup>, PSE

### Ordering details

For softstarter type	Pcs/ unit	Type	Order code	Pkg qty	Weight (1 pce) kg
PSE18	2	PSTHM-26/16	1SFA899210R1026	1	0.090
PSE25	2	PSTHM-26/16	1SFA899210R1026	1	0.090
PSE30	2	PSTHM-44/16	1SFA899210R1044	1	0.090
PSE37	2	PSTHM-44/16	1SFA899210R1044	1	0.090
PSE45	2	PSTHM-56/16	1SFA899210R1056	1	0.090
PSE60	2	PSTHM-95/16	1SFA899210R1095	1	0.090
PSE72	2	PSTHM-95/16	1SFA899210R1095	1	0.090
PSE85	2	PSTHM-132/16	1SFA899210R1132	1	0.125
PSE105	2	PSTHM-162/16	1SFA899210R1162	1	0.125
PSE142	2	PSTHM-162/16	1SFA899210R1162	1	0.125
PSE170	2	PSTHM-200/16	1SFA899210R1200	1	0.125
PSE210	2	PSTHM-312/16	1SFA899210R1312	1	0.750
PSE250	2	PSTHM-501/16	1SFA899210R1501	1	1.500
PSE300	2	PSTHM-501/16	1SFA899210R1501	1	1.500
PSE370	2	PSTHM-501/16	1SFA899210R1501	1	1.500

## SCR <sup>1)</sup>, PSS

### Ordering details

For softstarter type	Main Voltage	Pcs/ unit	Type	Order code	Pkg qty	Weight (1 pce) kg
PSS18	<= 600 V	3	PSTM-27/16	1SFA899010R1027	1	0.100
PSS30	<= 600 V	3	PSTM-42/16	1SFA899010R1042	1	0.100
PSS37	<= 600 V	3	PSTM-57/16	1SFA899010R1057	1	0.100
PSS44	<= 600 V	3	PSTM-92/16	1SFA899010R1092	1	0.100
PSS50	<= 600 V	3	PSTM-92/16	1SFA899010R1092	1	0.100
PSS60	<= 600 V	3	PSTM-132/16	1SFA899010R1132	1	0.250
PSS72	<= 600 V	3	PSTM-172/16	1SFA899010R1172	1	0.250
PSS85	<= 600 V	3	PSTM-172/16	1SFA899010R1172	1	0.250
PSS105	<= 600 V	3	PSTM-210/16	1SFA899010R1210	1	0.940
PSS142	<= 600 V	3	PSTM-250/16	1SFA899010R1250	1	0.940
PSS175	<= 600 V	3	PSTM-250/16	1SFA899010R1250	1	0.940
PSS250	<= 600 V	3	PSTM-500/16	1SFA899010R1500	1	1.420
PSS300	<= 600 V	3	PSTM-500/16	1SFA899010R1500	1	1.420
PSS18	<= 690 V	3	PSTM-27/18	1SFA899011R1027	1	0.100
PSS30	<= 690 V	3	PSTM-42/18	1SFA899011R1042	1	0.100
PSS37	<= 690 V	3	PSTM-57/18	1SFA899011R1057	1	0.100
PSS44	<= 690 V	3	PSTM-92/18	1SFA899011R1092	1	0.100
PSS50	<= 690 V	3	PSTM-92/18	1SFA899011R1092	1	0.100
PSS60	<= 690 V	3	PSTM-132/18	1SFA899011R1132	1	0.250
PSS72	<= 690 V	3	PSTM-172/18	1SFA899011R1172	1	0.250
PSS85	<= 690 V	3	PSTM-172/18	1SFA899011R1172	1	0.250
PSS105	<= 690 V	3	PSTM-210/18	1SFA899011R1210	1	0.940
PSS142	<= 690 V	3	PSTM-250/18	1SFA899011R1250	1	0.940
PSS175	<= 690 V	3	PSTM-250/18	1SFA899011R1250	1	0.940
PSS250	<= 690 V	3	PSTM-500/18	1SFA899011R1500	1	1.420
PSS300	<= 690 V	3	PSTM-500/18	1SFA899011R1500	1	1.420



PSTM

1) SCR: Silicon Controlled Rectifier.

# Spare parts softstarters

## SCR <sup>1)</sup>, PST and PSTX

### Ordering details

For softstarter type	Main Voltage	Pcs/ unit	Type	Order code	Pkg qty	Weight (1 pce) kg
PST30	<= 600 V	3	PSTM-42/16	1SFA899010R1042	1	0.100
PST37	<= 600 V	3	PSTM-57/16	1SFA899010R1057	1	0.100
PST44	<= 600 V	3	PSTM-92/16	1SFA899010R1092	1	0.100
PST50	<= 600 V	3	PSTM-92/16	1SFA899010R1092	1	0.100
PST60	<= 600 V	3	PSTM-132/16	1SFA899010R1132	1	0.250
PST72	<= 600 V	3	PSTM-172/16	1SFA899010R1172	1	0.250
PST85	<= 600 V	3	PSTM-172/16	1SFA899010R1172	1	0.250
PST105	<= 600 V	3	PSTM-210/16	1SFA899010R1210	1	0.940
PST142	<= 600 V	3	PSTM-250/16	1SFA899010R1250	1	0.940
PST175	<= 600 V	3	PSTM-250/16	1SFA899010R1250	1	0.940
PST210	<= 600 V	3	PSTM-330/16	1SFA899010R1330	1	0.750
PST250	<= 600 V	3	PSTM-500/16	1SFA899010R1500	1	1.420
PST300	<= 600 V	3	PSTM-500/16	1SFA899010R1500	1	1.420
PSTX30	<= 600 V	3	PSTHM-44/16	1SFA899210R1044	1	0.250
PSTX37	<= 600 V	3	PSTHM-56/16	1SFA899210R1056	1	0.250
PSTX45, 60	<= 600 V	3	PSTHM-95/16	1SFA899210R1095	1	0.250
PSTX72, 85	<= 600 V	3	PSTHM-132/16	1SFA899210R1132	1	0.330
PSTX105	<= 600 V	3	PSTHM-162/16	1SFA899210R1162	1	0.330
PSTX142	<= 600 V	3	PSTHM-200/16	1SFA899210R1200	1	0.330
PSTX170, 210	<= 600 V	3	PSTHM-312/16	1SFA899210R1312	1	0.840
PSTX250, 300, 370	<= 600 V	3	PSTHM-501/16	1SFA899210R1501	1	1.500
PST30	<= 690 V	3	PSTM-42/18	1SFA899011R1042	1	0.100
PST37	<= 690 V	3	PSTM-57/18	1SFA899011R1057	1	0.100
PST44	<= 690 V	3	PSTM-92/18	1SFA899011R1092	1	0.100
PST50	<= 690 V	3	PSTM-92/18	1SFA899011R1092	1	0.100
PST60	<= 690 V	3	PSTM-132/18	1SFA899011R1132	1	0.250
PST72	<= 690 V	3	PSTM-172/18	1SFA899011R1172	1	0.250
PST85	<= 690 V	3	PSTM-172/18	1SFA899011R1172	1	0.250
PST105	<= 690 V	3	PSTM-210/18	1SFA899011R1210	1	0.940
PST142	<= 690 V	3	PSTM-250/18	1SFA899011R1250	1	0.940
PST175	<= 690 V	3	PSTM-250/18	1SFA899011R1250	1	0.940
PST210	<= 690 V	3	PSTM-330/18	1SFA899011R1330	1	0.750
PST250	<= 690 V	3	PSTM-500/18	1SFA899011R1500	1	1.420
PST300	<= 690 V	3	PSTM-500/18	1SFA899011R1500	1	1.420
PSTX30	<= 690 V	3	PSTHM-44/18	1SFA899311R1044	1	0.250
PSTX37	<= 690 V	3	PSTHM-56/18	1SFA899311R1056	1	0.250
PSTX45, 60	<= 690 V	3	PSTHM-95/18	1SFA899311R1095	1	0.250
PSTX72, 85	<= 690 V	3	PSTHM-132/18	1SFA899311R1132	1	0.330
PSTX105	<= 690 V	3	PSTHM-162/18	1SFA899311R1162	1	0.330
PSTX142	<= 690 V	3	PSTHM-200/18	1SFA899311R1200	1	0.330
PSTX170, 210	<= 690 V	3	PSTHM-312/18	1SFA899311R1312	1	0.840
PSTX250, 300, 370	<= 690 V	3	PSTHM-501/18	1SFA899311R1501	1	1.500

1) SCR: Silicon Controlled Rectifier.

3



PSTM



PSTX

# Spare parts softstarters

## SCR <sup>1)</sup>, PSTB

### Ordering details



PSTP

For softstarter type	Main Voltage	Pcs/ unit	Type	Order code	Pkg qty	Weight (1 pce) kg
PSTB370	<= 600 V	6	PSTP-280/16	1SFA899008R1280	1	0.090
PSTB470	<= 600 V	6	PSTP-960/18	1SFA899008R1960	1	0.340
PSTB570 <sup>2)</sup>	<= 600 V	6	PSTP-540/16	1SFA899008R1540	1	0.510
PSTB720	<= 600 V	6	PSTP-540/16	1SFA899008R1540	1	0.510
PSTB840	<= 600 V	6	PSTP-600/16	1SFA899008R1600	1	0.510
PSTB1050	<= 600 V	6	PSTP-990/16	1SFA899008R1990	1	1.000
PSTB370	<= 690 V	6	PSTP-280/18	1SFA899009R1280	1	0.090
PSTB470	<= 690 V	6	PSTP-960/18	1SFA899008R1960	1	0.340
PSTB570 <sup>3)</sup>	<= 690 V	6	PSTP-540/18	1SFA899009R1540	1	0.510
PSTB720	<= 690 V	6	PSTP-540/18	1SFA899009R1540	1	0.510
PSTB840	<= 690 V	6	PSTP-760/18	1SFA899009R1760	1	1.000
PSTB1050	<= 690 V	6	PSTP-1400/18	1SFA899009R2400	1	1.700

2) Shall be used for PSTB570-600 manufactured after Serial number: 1S160100115411189.

3) Shall be used for PSTB570-690 manufactured after Serial number: 1S160100115211256.

## SCR <sup>1)</sup> clamp upgrade kit

### Ordering details

For softstarter type	Main Voltage	Pcs/ unit	Type	Order code	Pkg qty	Weight (1 pce) kg
PSTB570 <sup>2)</sup>	600 V	6	PSTPK-540/16	1SFA899108R1540	6	3.353
PSTB570 <sup>3)</sup>	690 V	6	PSTPK-540/18	1SFA899109R1540	6	3.341

2) Shall be used for PSTB570-600 manufactured before Serial number: 1S160100115411189.

3) Shall be used for PSTB570-690 manufactured before Serial number: 1S160100115211256.

## Kit for changing SCR <sup>1)</sup>

### Description

Heat transfer compound

### Ordering details

For softstarter type	Remark	Type	Order code	Pkg qty	Weight (1 pce) kg
PSE18...370	Sufficient for replacing 10 thyristor blocks	PSPB-1	1SFA899012R1001		0.050
PSS18...300	Sufficient for replacing 10 thyristor blocks	PSPB-1	1SFA899012R1001		0.05
PST30...300	Sufficient for replacing 10 thyristor blocks	PSPB-1	1SFA899012R1001		0.050
PSTB370...1050	Sufficient for replacing 20 thyristor disc	PSPB-2	1SFA899012R1002		0.050

1) SCR: Silicon Controlled Rectifier.

# Spare parts softstarters

## Semiconductor fuses type Bussmann, PSS, PST and PSTB

### Ordering details

Softstarter For Softstarter type	Main Voltage (V)	Fuses				Order code	Bussmann Type	Holders Type	Pkg qty	Weight (1 pce) kg
		Pcs/ soft- starter unit	Rating current A	Type						
PSS18	500/690	3	50	PSFU-50	1SFA899005R1364	170M1364	1	1	0.140	
PSS30	500/690	3	80	PSFU-80	1SFA899005R1366	170M1366	1	1	0.140	
PSS37	500/690	3	125	PSFU-125	1SFA899005R1368	170M1368	1	1	0.140	
PSS44	500/690	3	160	PSFU-160	1SFA899005R1369	170M1369	1	1	0.140	
PSS50	500/690	3	160	PSFU-160	1SFA899005R1369	170M1369	1	1	0.140	
PSS60	500/690	3	200	PSFU-200	1SFA899005R1370	170M1370	1	1	0.140	
PSS72	500/690	3	250	PSFU-250	1SFA899005R1371	170M1371	1	1	0.140	
PSS85	500/690	3	315	PSFU-315	1SFA899005R1372	170M1372	1	1	0.140	
PSS105	500/690	3	400	PSFU-400	1SFA899005R3019	170M3019	2	1	0.300	
PSS142	500/690	3	450	PSFU-450	1SFA899005R3020	170M3020	2	1	0.300	
PSS175	500/690	3	500	PSFU-500	1SFA899005R3021	170M3021	2	1	0.300	
PSS250	500/690	3	700	PSFU-700	1SFA899005R5013	170M5013	2	1	0.600	
PSS300	500/690	3	900	PSFU-900	1SFA899005R5015	170M5015	2	1	0.600	
PST30	600/690	3	80	PSFU-80	1SFA899005R1366	170M1366	1	1	0.140	
PST37	600/690	3	125	PSFU-125	1SFA899005R1368	170M1368	1	1	0.140	
PST44	600/690	3	160	PSFU-160	1SFA899005R1369	170M1369	1	1	0.140	
PST50	600/690	3	160	PSFU-160	1SFA899005R1369	170M1369	1	1	0.140	
PST60	600/690	3	200	PSFU-200	1SFA899005R1370	170M1370	1	1	0.140	
PST72	600/690	3	250	PSFU-250	1SFA899005R1371	170M1371	1	1	0.140	
PST85	600/690	3	315	PSFU-315	1SFA899005R1372	170M1372	1	1	0.140	
PST105	600/690	3	400	PSFU-400	1SFA899005R3019	170M3019	2	1	0.140	
PST142	600/690	3	450	PSFU-450	1SFA899005R3020	170M3020	2	1	0.300	
PST175	600/690	3	500	PSFU-500	1SFA899005R3021	170M3021	2	1	0.300	
PST210	600/690	3	630	PSFU-630	1SFA899005R5012	170M5012	2	1	0.300	
PST250	600/690	3	700	PSFU-700	1SFA899005R5013	170M5013	2	1	0.600	
PST300	600/690	3	900	PSFU-900	1SFA899005R5015	170M5015	2	1	0.600	
PSTB370	600/690	3	700	PSFU-700	1SFA899005R5013	170M5013	2	1	0.600	
PSTB470	600/690	3	900	PSFU-900	1SFA899005R5015	170M5015	2	1	0.600	
PSTB570	600/690	3	900	PSFU-900	1SFA899005R5015	170M5015	2	1	0.600	
PSTB720	600/690	3	1250	PSFU-1250	1SFA899005R5018	170M5018	2	1	0.600	
PSTB840	600/690	3	1500	PSFU-1500	1SFA899005R6018	170M6018	2	1	0.830	
PSTB1050	600	3	1800	PSFU-1800	1SFA899005R6020	170M6020	2	1	0.830	
PSTB1050	690	3	1600	PSFU1600	1SFA899005R6019	170M6019	2	1	0.830	

## Fuse holders

### Ordering details

Holders type	Pcs / softstarter unit	Type	Order code	Bussmann type	Pkg qty	Weight (1 pce) kg
1	3	PSFH-1	1SFA899006R1007	170H1007	1	0.240
2	3	PSRH-2	1SFA899006R3004	170H3004	1	1.420

# Spare parts softstarters

## Current transformers, PSS, PST and PSTB

### Ordering details

For softstarter type	Current transf. pcs / softstarter unit	Ratio	Type	Order code	Pkg qty	Weight (1 pce) kg
PSS18	1	30/1	PSCT-30	1SFA 899001R1030	1	0.200
PSS30	1	40/1	PSCT-40	1SFA 899001R1040	1	0.200
PSS37	1	50/1	PSCT-50	1SFA 899001R1050	1	0.200
PSS44	1	60/1	PSCT-60	1SFA 899001R1060	1	0.200
PSS50	1	75/1	PSCT-75	1SFA 899001R1075	1	0.200
PSS60	1	75/1	PSCT-75	1SFA 899001R1075	1	0.200
PSS72	1	100/1	PSCT-100	1SFA 899001R1100	1	0.150
PSS85	1	125/1	PSCT-125	1SFA 899001R1125	1	0.150
PSS105	1	150/1	PSCT-150	1SFA 899001R1150	1	0.150
PSS142	1	200/1	PSCT-200	1SFA 899001R1200	1	0.250
PSS175	1	250/1	PSCT-250	1SFA 899001R1250	1	0.250
PSS250	1	400/1	PSCT-400	1SFA 899001R1400	1	0.200
PSS300	1	400/1	PSCT-400	1SFA 899001R1400	1	0.200
PST30	3	30/1	PSCT-30	1SFA 899001R1030	1	0.200
PST37	3	40/1	PSCT-40	1SFA 899001R1040	1	0.200
PST44	3	50/1	PSCT-50	1SFA 899001R1050	1	0.200
PST50	3	50/1	PSCT-50	1SFA 899001R1050	1	0.200
PST60	3	60/1	PSCT-60	1SFA 899001R1060	1	0.200
PST72	3	75/1	PSCT-75	1SFA 899001R1075	1	0.200
PST85	3	100/1	PSCT-100	1SFA 899001R1100	1	0.150
PST105	3	125/1	PSCT-125	1SFA 899001R1125	1	0.150
PST142	3	150/1	PSCT-150	1SFA 899001R1150	1	0.150
PST175	3	200/1	PSCT-200	1SFA 899001R1200	1	0.250
PST210	3	250/1	PSCT-250	1SFA 899001R1250	1	0.250
PST250	3	250/1	PSCT-250	1SFA 899001R1250	1	0.250
PST300	3	300/1	PSCT-300	1SFA 899001R1300	1	0.300
PSTB370	3	400/1	PSCT-400	1SFA 899001R1400	1	0.200
PSTB470	3	500/1	PSCT-500	1SFA 899001R1500	1	0.300
PSTB570	3	600/1	PSCT-600	1SFA 899001R1600	1	0.300
PSTB720	3	750/1	PSCT-750	1SFA 899001R1750	1	0.300
PSTB840	3	1000/1	PSCT-1000	1SFA 899001R2000	1	0.300
PSTB1050	3	1200/1	PSCT-1200	1SFA 899001R2200	1	0.300



PSCT

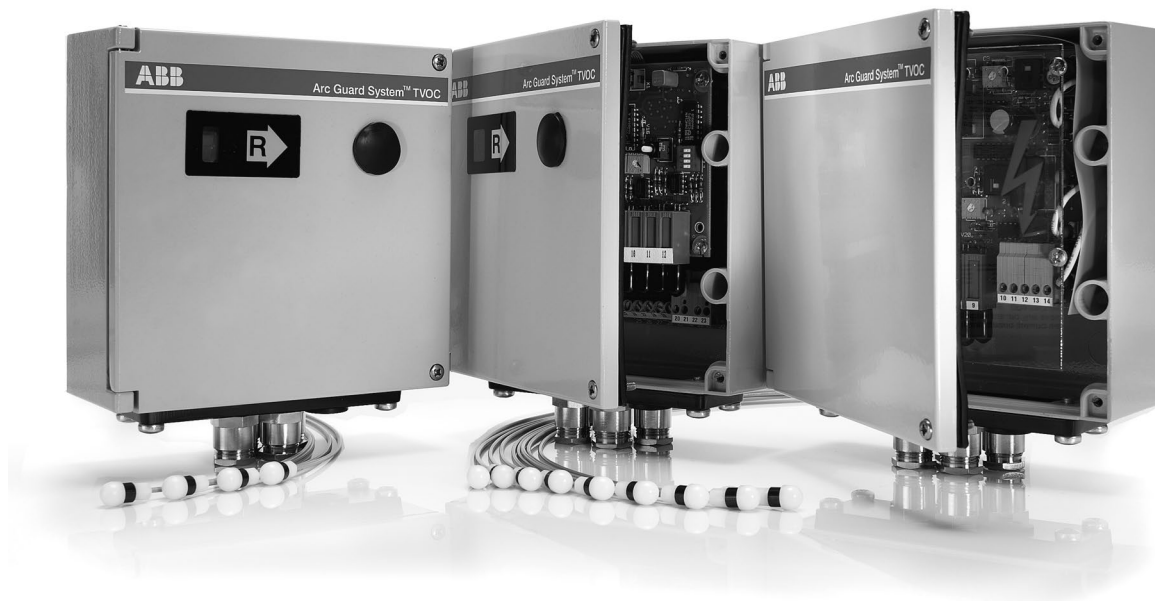



## Spare parts arc guard Arc guard system TVOC

Arc monitor	4/2
Detector	4/2
Optical cable	4/3
Mounting bracket	4/3
Mounting kit	4/3
Label	4/3
Flush mounting set	4/3

# Spare parts arc guard

## Arc monitor - Detectors

### Arc monitor

#### Ordering details

For power supply voltage	Type	Order code	Pkg qty	Weight (1 pce) kg
60...220 V, DC or 60...240 V, 50/60 Hz		1SFA663001R1001		1.680
24...48 V, DC		1SFA663001R1002		1.680

### Arc monitor - simplified version

#### Ordering details

For power supply voltage	Type	Order code	Pkg qty	Weight (1 pce) kg
60...220 V, DC or 60...240 V, 50/60 Hz		1SFA663001R1003		
24...48 V, DC		1SFA663001R1004		

### Detectors with optical cable of plastic fibre

#### Ordering details

Cable length	Order code	Pkg qty	Weight (1 pce) kg
1 m	1SFA663003R1010		0.020
2 m	1SFA663003R1020		0.020
4 m	1SFA663003R1040		0.040
6 m	1SFA663003R1060		0.060
8 m	1SFA663003R1080		0.080
10 m	1SFA663003R1100		0.100
15 m	1SFA663003R1150		0.150
20 m	1SFA663003R1200		0.200
25 m	1SFA663003R1250		0.200
30 m	1SFA663003R1300		0.300
other lengths on request			

# Spare parts arc guard

## Accessories

### Optical cables

#### Ordering details

Cable length	Order code	Pkg qty	Weight (1 pce) kg
0.5 m	1SFA663004R1000		0.010
1 m	1SFA663004R1010		0.010
2 m	1SFA663004R1020		0.020
4 m	1SFA663004R1040		0.040
6 m	1SFA663004R1060		0.060
8 m	1SFA663004R1080		0.080
10 m	1SFA663004R1100		0.100
15 m	1SFA663004R1150		0.150
20 m	1SFA663004R1200		0.200
25 m	1SFA663004R1250		0.250
30 m	1SFA663004R1300		0.300

4

### Mounting bracket set

#### Ordering details

	Order code	Pkg qty	Weight (1 pce) kg
One set including 5 pcs of bracket and 10 pcs if cable strap	1SFA663006R1010		0.250

### Mounting kit

#### Ordering details

	Order code	Pkg qty	Weight (1 pce) kg
600 mm	1SFA663006R1001		0.350
800/1000 mm	1SFA663006R1002		0.600

### Label

#### Ordering details

	Order code	Pkg qty	Weight (1 pce) kg
One set including 10 pcs	1SFA663005R1001		0.020

### Flush mounting set

#### Ordering details

	Order code	Pkg qty	Weight (1 pce) kg
Consisting of mounting bracket, gasket and screws	1SFA663006R1015		0.530

# Contact us

## **ABB AB**

### **Low Voltage Products**

SE-721 61 VÄSTERÅS, Sweden

## **ABB France**

### **Low Voltage Products Division**

3, rue Jean Perrin

F-69687 Chassieu cedex, France



Service for control  
and protection



<http://www.abb.com/lowvoltage>

## **Note**

We reserve the right to make technical changes or modify the contents of this document without prior notice.

ABB does not accept any responsibility whatsoever for potential errors or possible lack of information in this document.

We reserve all rights in this document and in the subject matter and illustrations contained therein. Any reproduction, disclosure to third parties or utilization of its contents – in whole or in parts – is forbidden without prior written consent of ABB.

Copyright© 2015 ABB - All rights reserved