

Photoelectrics Amplifier Type S142A..

CARLO GAVAZZI



- μ -Processor controlled
- Amplifier relay for photoelectric switches
- Automatic or manual emitter power regulation
- Self-diagnostic functions
- Alignment help
- Timer option, S142B..
- Rated operational voltage:
24 VAC/DC, 24 VAC, 115 VAC or 230 VAC
- Output 8 A/250 VAC SPDT relay and 100 mA NPN
- LED indication: Automatic gain, output, level, emitter or receiver fault



Product Description

μ -processor controlled amplifier for one set of photoelectric sensors, type MOFTR (see separate datasheet for MOFT... and MOFR...). Utilizes an 11-pin circular plug for easy connection. 8 A SPDT relay output, NPN / PNP transistor output or

alarm output. Diagnostics for sensor test during operation. Alignment help via LED or alternation of alarm output. Level indication for dirt accumulation. Manual or automatic emitter power regulation. Two emitter codes available for high neighbour immunity.

Ordering Key

S142 A RNN 924

Type _____
 Special function _____
 Output type _____
 (R-Relay, N-NPN, P-PNP, T-Test)
 Power supply _____

Type Selection

Function diameter	Ordering no. Supply: 24 VAC/DC	Ordering no. Supply: 24 VAC	Ordering no. Supply: 115 VAC	Ordering no. Supply: 230 VAC
NPN output & Test input	S142 A RNT 924	S142 A RNT 024	S142 A RNT 115	S142 A RNT 230
NPN output & Alarm output	S142 A RNN 924¹⁾	S142 A RNN 024¹⁾	S142 A RNN 115¹⁾	S142 A RNN 230¹⁾
PNP out., PNP alarm & Test	S142 A PPT 924		S142 A PPT 115	S142 A PPT 230

¹⁾ Amplifier replacement for S1420156xxx

Specifications

Rated operational voltage (U_B) Pins 2 & 10	230 115 024 924	195 to 265 VAC, 45 to 65 Hz 98 to 132 VAC, 45 to 65 Hz 20.4 to 27.6 VAC, 45 to 65 Hz 20.4 to 27.6 VAC/DC Class 2	Output function Relay Transistor Alarm	Make or break on DIP-switch SPDT NPN / PNP, 100 mA, 10-40 VDC NPN / PNP, 100 mA, 10-40 VDC Delay on alarm 10 sec
Rated operational power AC supply AC/DC supply	3.3 VA 1.6 VA / 1.4 W		Test input (Mute) Emitter enabled Emitter disabled I _{max} @ 40 VDC	NPN > 5.0 VDC < 3.0 VDC 1 mA PNP < V _{CC} - 3 VDC > V _{CC} - 5 VDC
Delay on operate (t_v)	< 300 mS		Protection output transistor	Reverse polarity, short circuit and transients
Outputs Relay Rating (AgCdO) Resistive loads AC1 DC1 or Electrical life (typical) AC1	μ (micro gap) 8 A / 250 VAC (2500 VA) 0.2 A / 250 VDC (50 W) 2 A 25 VDC (50 W) > 100.000 operations		Supply to sensors Emitter Supply voltage (open loop) Current Output resistance Receiver Supply voltage (open loop) Short-circuit current Input resistance	Pins 5 & 7 15 V square wave < 450 mA, short circuit protected 10 Ω Pins 6 & 8 5 VDC 10 mA 470 Ω
Transistor output data Output current (I _e) Voltage drop (U _d)	< 100 mA @ 10-40 VDC (max. load capacity 100 nF) < 2,5 VDC @ 100 mA			

Specifications

Emitter power Power	Settings on DIP switch no 4, 50 % or 100 % range	Response time OFF-ON (t_{ON}) ON-OFF (t_{OFF})	20 mS 30 mS
Sensitivity adjustment Manual Automatic /Auto LED ON)	240° Potentiometer Potentiometer settings fully counter clockwise	Environment Overvoltage category Degree of protection Pollution degree	III (IEC 60664) IP 20 /IEC 60529, 60947-1) 3 (IEC 60664/60664A, 60947-1)
Max. sensing distance	Maximum range indicated on photoelectric switch data- sheets in 100 % settings	Temperature Operating Storage	-20° to +50°C (-4° to +122°F) -50° to +85°C (-58° to +185°F)
Rated insulation voltage (U)	250 VAC	Housing material	NORYL SE1, light grey
Dielectric voltage	>2.0 KVAC (rms) (contacts / electronics)	Weight AC supply AC/DC supply	200 g 125 g
Rated impulse withstand volt.	4 kV (1.2/50 μ S) (contacts / electronics) (IEC 664)	Approvals	UL508, UL325*, CSA
Operating frequency (f) Light / Dark ratio Relay output Transistor output	1:1 20 HZ 20 HZ	CE marking	EN12445, EN12453, EN12978

* Must be approved in the final door installation

Specifications

Diagnostics

If a fault occurs on either the emitter or receiver the Alarm LED and output will turn ON.

Receiver fault

During normal operation the receiver is monitored for faults.

If the wires are short-circuited the "Code A, Yellow LED" flashes at a rate of 2 Hz.

If the wires are broken the "Code A, Yellow LED" flashes at a rate of 4 Hz.

Emitter fault

During normal operation the emitter is monitored for faults.

If the wires are short-circuited the "Code B, Green LED" flashes at a rate of 2 Hz.

If the wires are broken the "Code B, Green LED" flashes at a rate of 4 Hz.

Alignment

If the alignment DIP switch is set the Yellow Signal LED Flashes according to the signal quality.

Low frequency means weak signal.

Steady indication means maximum signal. On long distance it is not possible to get a steady signal but the alignment is optimal when

the led flashes with the highest frequency.

On short distance the sensitivity can be reduced using the potentiometer and then get better readings in the alignment LED.

The ALARM output will follow the Signal LED in alignment mode, so a Sensor tester (optional) can be connected to serve as a remote indication during alignment of the sensors.

NB! In alignment mode the output is off.

Code A or B

When two sensor pairs are mounted close to each other

it is recommended to select one set to Code A and the other to Code B to minimize crosstalk.

Dirt reserve

For optimal detection excess gain settings can be selected using the Level Low/High DIP switch:

- High: Allows high dirt build-up.
- Low: Allows detection of semi-transparent objects.

Power settings

To avoid a too strong emitter the power can be reduced to 50% reducing the max distance to 25%

Wiring Diagram

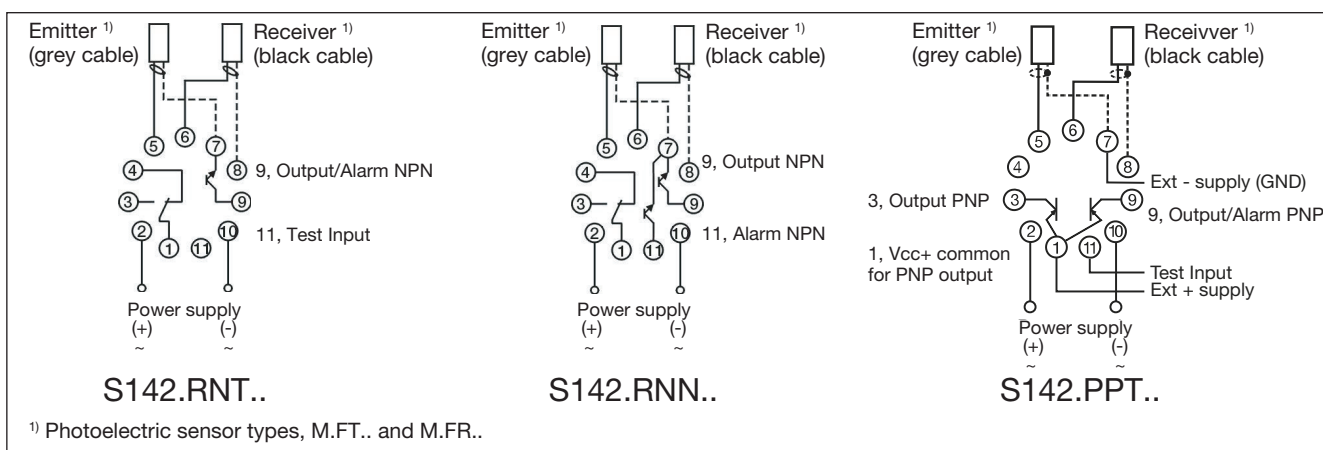

Operation Diagram

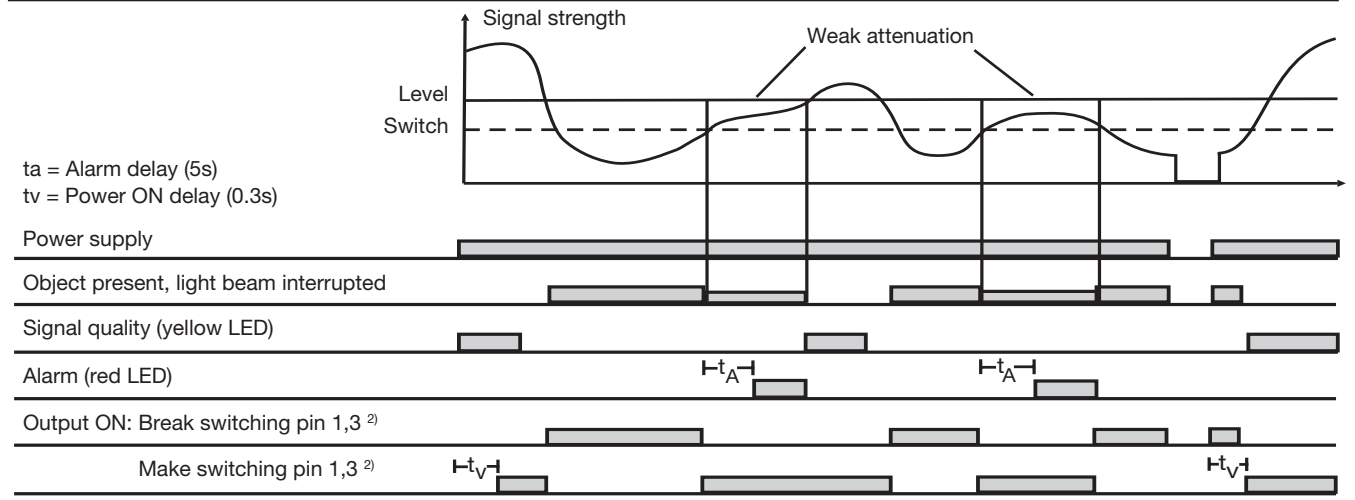

²⁾ Switching function selected by DIP-switch, inverted function on pin 1, 4

Dimensions

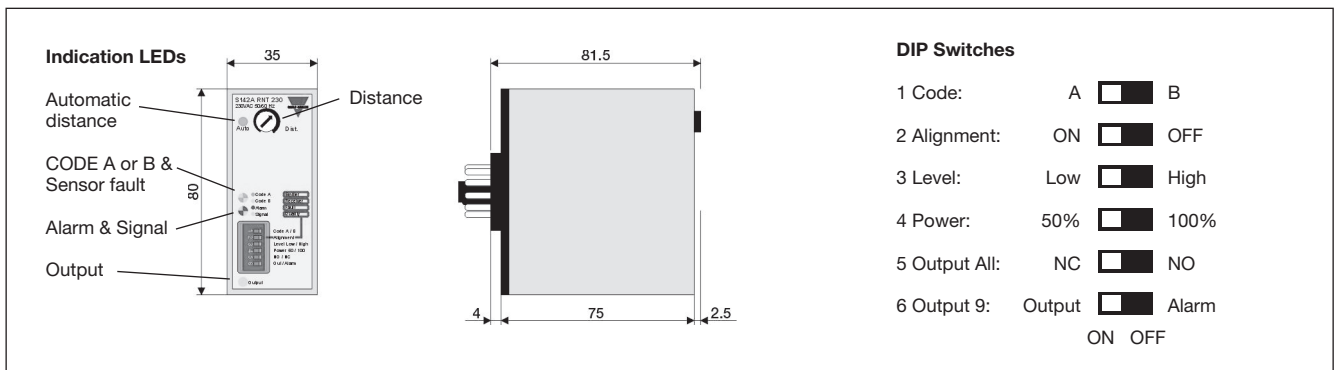

Connection to sortester

Connection to sortester ST-03 for alignment

	Sortester		
	-	Signal	+
RNT Pin no.	10	9	
RNN Pin no.	10	11	
PPT Pin no.		9	2

Accessories

- 11 pole circular socket ZPD11
- Holding down spring HF
- Mounting rack SM13
- Front panel mounting bezel FRS2

Delivery Contents

- Amplifier
- **Packaging:** Carton box



Installation of industrial doors in compliance with the UL325 standard

Connections

- 1) Connect the supply wires to the amplifier (for DC systems: + on terminal 2, - on terminal 10).
- 2) Make sure that the power is within the specified tolerances and employed as required by the local codes.

Mounting

- 1) When installing the sensors, make sure that the maximum range is not exceeded and - if 2 separate systems are mounted close to each other - place the sensors so cross-talk is avoided.
- 2) To protect the receiver and the transmitter against damage, proper fittings must be used in the installation.
- 3) The amplifier must be mounted in an appropriate enclosure to protect it against mechanical as well as electrical damage and fire.
- 4) Do not apply power to the amplifier before the sensors are connected.
- 5) Connect the receiver and the emitter to the dedicated terminals.

- 6) Apply power to the amplifier.
- 7) The yellow LED's for the output should be ON (N.O.), OFF (N.C.) with no object present.
Note: For systems with test input, be sure that the Emitter is enabled.
- 8) Interrupt the light beam and make sure that the yellow LED turns OFF (N.O), turns ON (N.C.).

For each door cycle:

The connected door controller must verify that the sensors operate properly, by testing the sensor function using the test input in at least one of the doors' end position.

CAUTION

Not for use and mounting as a separate accessory. Only for incorporation by a professional inside a door, drapery, gate, louver or window operator or system after evaluation of the combination (assembly) has shown compliance with the applicable standards.