

SIMOCODE® pro
Grundgerät
Basic Unit
Appareil de base
Módulo base
Unità base
Dispositivo-base

3UF70.0-1A.00-0



Betriebsanleitung
 Instructivo

Operating Instructions
 Istruzioni operative

Instructions de service
 Instruções de Serviço

Bestell-Nr./Order No.: 3ZX1012-0UF70-1AA1

Vor der Installation, dem Betrieb oder der Wartung des Geräts muss diese Anleitung gelesen und verstanden werden.
 Read and understand these instructions before installing, operating, or maintaining the equipment.
 Ne pas installer, utiliser ou intervenir sur cet équipement avant d'avoir lu et assimilé ces instructions.
 Leer y comprender este instructivo antes de la instalación, operación o mantenimiento del equipo.
 Leggere con attenzione queste istruzioni prima di installare, utilizzare o eseguire manutenzione su questa apparecchiatura.
 Ler e compreender estas instruções antes da instalação, operação ou manutenção do equipamento.

	⚠ GEFAHR Gefährliche Spannung. Lebensgefahr oder schwere Verletzungsgefahr. Vor Beginn der Arbeiten Anlage und Gerät spannungsfrei schalten.	⚠ DANGER Hazardous voltage. Will cause death or serious injury. Disconnect power before working on equipment.	⚠ DANGER Tension dangereuse. Danger de mort ou risque de blessures graves. Mettre hors tension avant d'intervenir sur l'appareil.
	⚠ PELIGRO Tensión peligrosa. Puede causar la muerte o lesiones graves. Desconectar la alimentación eléctrica antes de trabajar en el equipo.	⚠ PERICOLO Tensione pericolosa. Può provocare morte o lesioni gravi. Scollegare l'alimentazione prima di eseguire interventi sull'apparechiatura.	⚠ PERIGO Tensão perigosa. Perigo de morte ou ferimentos graves. Desligue a corrente antes de trabalhar no equipamento.

Eine sichere Gerätefunktion ist nur mit zertifizierten Komponenten gewährleistet.
 Reliable functioning of the equipment is only ensured with certified components.
 Le fonctionnement sûr de l'appareil n'est garanti qu'avec des composants certifiés.
 El funcionamiento seguro del aparato sólo está garantizado con componentes certificados.
 Il funzionamento sicuro dell'apparechiatura è garantito soltanto con componenti certificati.
 O funcionamento seguro do aparelho apenas pode ser garantido se forem utilizados os componentes certificados.

Weitere Informationen:
 For further information:
 Pour de plus amples informations :
 Más información:
 Per ulteriori informazioni:
 Mais informações:

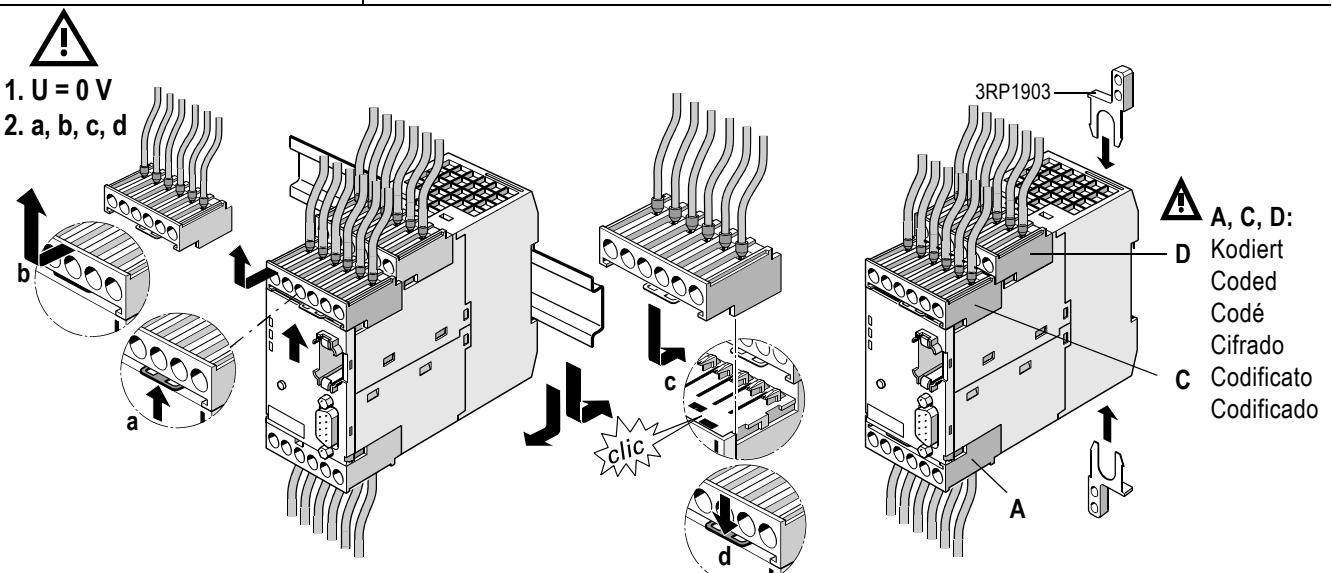
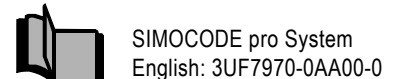
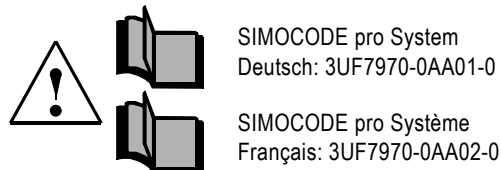

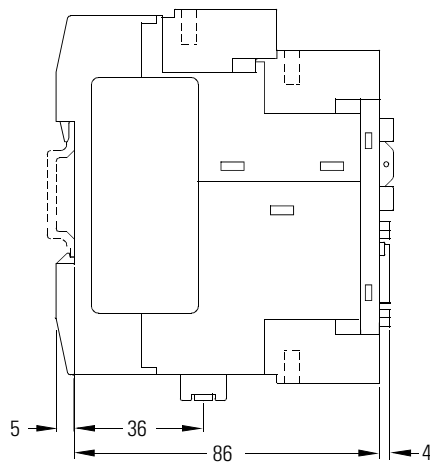
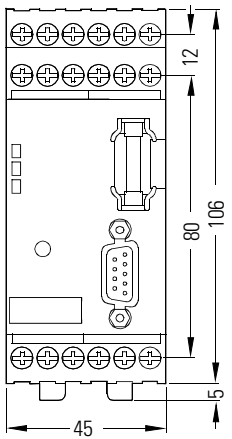



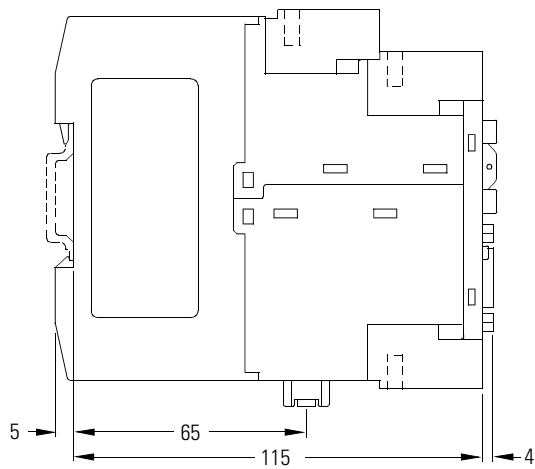
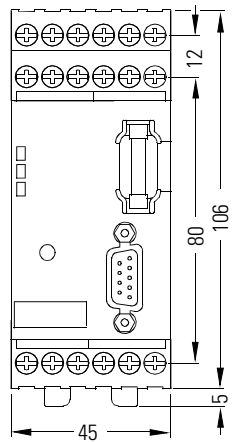
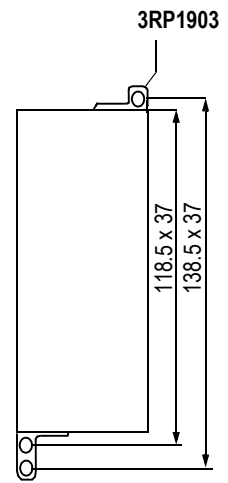

3UF7000-1AB00-0
3UF7000-1AU00-0

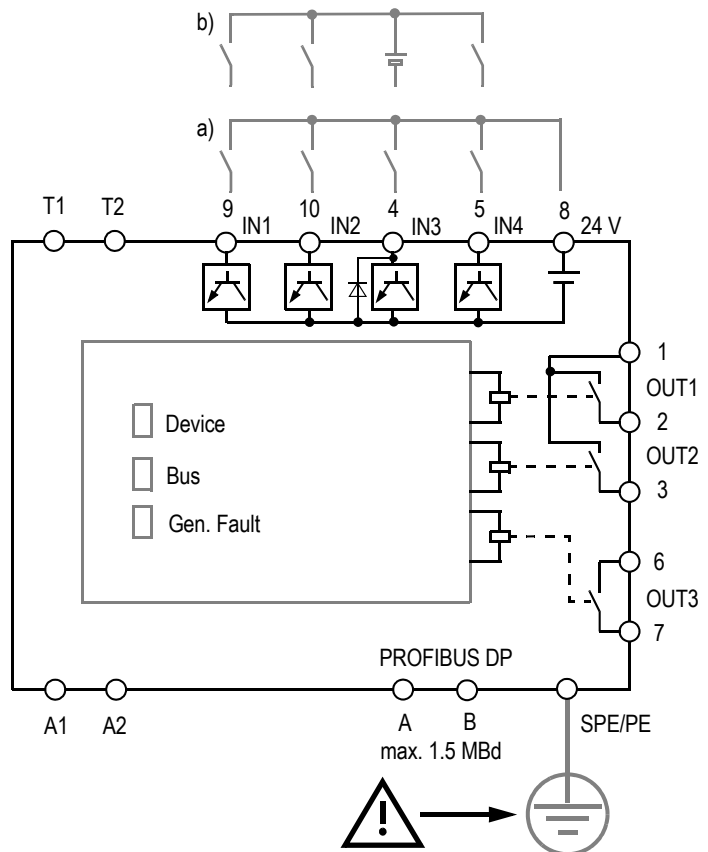
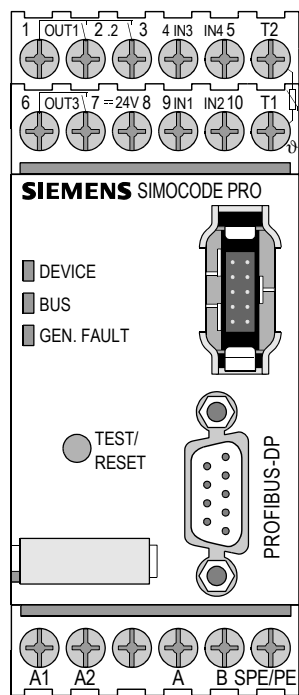

3UF7010-1AB00-0
3UF7010-1AU00-0

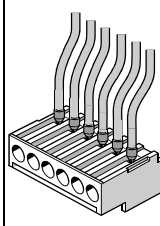

Order No.		A1/A2	T1/T2
3UF7000-1AB00-0	24 V DC	A1 (+) / A2 (-)	 PTC
3UF7000-1AU00-0	110 V ... 240 V AC / DC	A1 / A2	
3UF7010-1AB00-0	24 V DC	A1 (+) / A2 (-)	
3UF7010-1AU00-0	110 V ... 240 V AC / DC	A1 / A2	

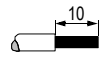
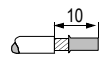
	 PZ2/ Ø 5 ... 6 mm	TORQUE: 7 ... 10.3 LB.IN 0,8 ... 1,2 Nm
	 10	2 x 0,5 ... 2,5 mm ² /1 x 0,5 ... 4 mm ² 2 x AWG 20 to 14/1 x AWG 20 to 12
	 10	2 x 0,5 ... 1,5 mm ² /1 x 0,5 ... 2,5 mm ² 2 x AWG 20 to 16/1 x AWG 20 to 14

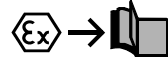
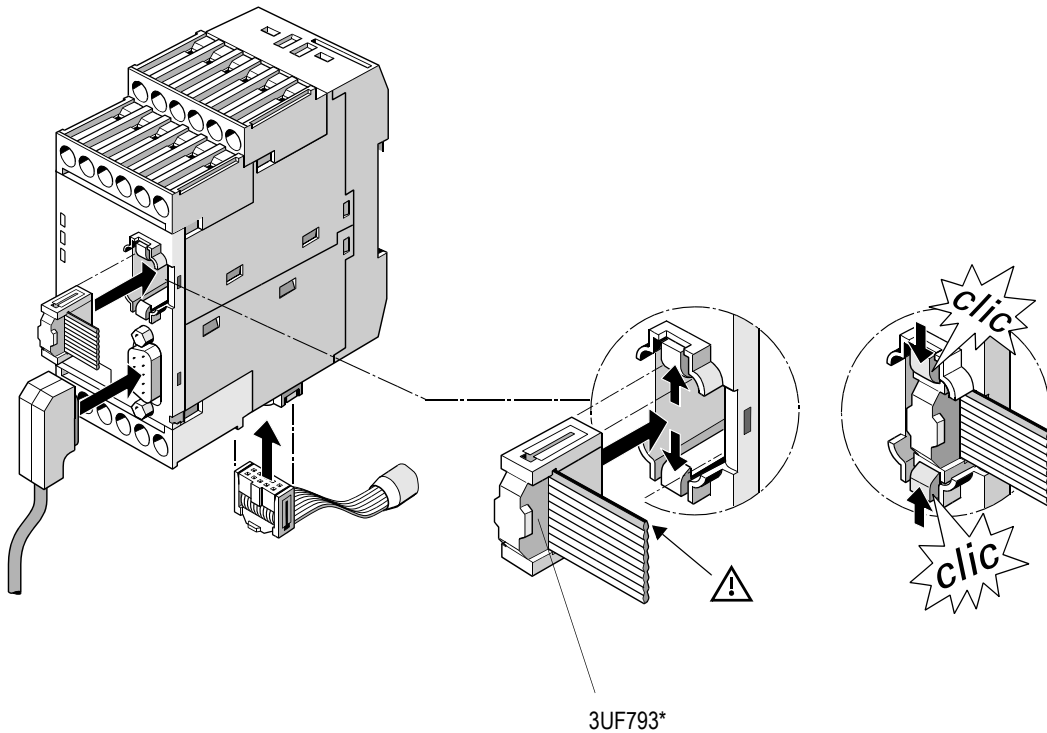

Deutsch: 3UF7970-0AA01-0
 English: 3UF7970-0AA00-0
 Français: 3UF7970-0AA02-0

Technical Assistance: Telephone: +49 (0) 911-895-5900 (8° - 17° CET)
 E-mail: technical-assistance@siemens.com
 Internet: www.siemens.de/lowvoltage/technical-assistance

Fax: +49 (0) 911-895-5907

Technical Support: Telephone: +49 (0) 180 50 50 222

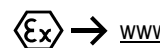

www.siemens.com/lowvoltage/manuals