

## UL 1686 C1 Pin and Sleeve

### Accessories

## Metallic Feed-Thru Back Box

# HUBBELL

### Ordering Information

Description	UPC	Catalog Number
Metallic Back Box, Pin and Sleeve Insulgrip, Feed Through	783585010809	MB605W

**Product Type**  
Accessories

### Standards

UL Listed  
CSA Certified

### Specifications

Gaskets	Neoprene
Hinge Spring	Stainless Steel
Assembly Screws	Stainless Steel
Box Hub Size	1 1/4" NPT

### Performance

**Electrical**  
Current Interrupting Certified for current interrupting at full rated current

Dielectric Voltage Withstands 3,000V AC  
Max Working Voltage 600V AC RMS

**Mechanical**  
Impact Resistance In accordance with UL746C  
Product Identification Identification and ratings are a part of the external label and molded into the receptacle mount  
Terminal Identification Terminals identified in accordance with North American and International conventions

**Environmental**  
Flammability UL94-5VA and V-0 classification  
Operating Temperatures Max. Continuous: 75° C; Min. Continuous: -40° C w/o impact

### Online Resources

Customer Use Drawing  
eCatalog  
Installation Instructions

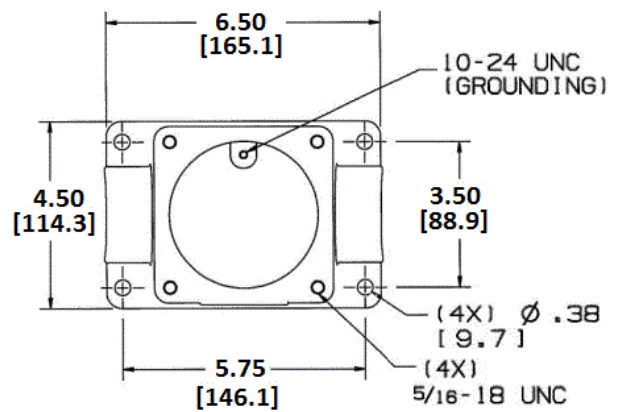

Dimensions in Inches (mm)

Hubbell Wiring Device-Kellems • Hubbell Incorporated (Delaware) • 40 Waterview Drive • Shelton, CT 06484

Phone (800) 288-6000 • Fax (800) 255-1031 • Specifications subject to change without notice.

