

contents

Section Overview 10/2 - 10/3

3SB2, 16mm Mounting Diameter Pilot Devices

Introduction	10/4
Technical Specifications	10/5
PCB Mounting Instructions	10/6
Complete Units	10/7 - 10/8
Pushbutton and Selector Switch Operators	10/9
Key-operated Switches and Indicator Lights	10/10
Holders, Lampholders and Contact Blocks with Tabs	10/11
Holders, Lampholders and Contact Blocks with Solder Pins	10/12
Inserts, Legend Plates, and Accessories	10/13 - 10/19
Dimension Drawings	10/20

SIRIUS ACT 3SU Series

Introduction	10/22 - 10/23
General Data	10/24 - 10/37
Actuators and indicators, 22 mm, round, plastic, black	
Complete Units	10/38 - 10/44
Compact Units	10/45 - 10/46
Actuating and Signaling Elements	10/47 - 10/58
Actuators and indicators, 22 mm, round, plastic with metal front ring, matte	
Complete Units	10/59 - 10/64
Compact Units	10/65 - 10/66
Actuating and Signaling Elements	10/67 - 10/78
Actuators and indicators, 22 mm, round, metal, shiny	
Complete Units	10/79 - 10/84
Compact Units	10/85 - 10/87
Actuating and Signaling Elements	10/88 - 10/97
Actuators and indicators, flat, 30 mm, round, metal, matte	
Actuating and Signaling Elements	10/98 - 10/100
Special locks	10/101
Customized Designs	10/102 - 10/104
Holders	
Holders without module	10/105
Holders with module	10/106
Modules for actuators and indicators	
Contact modules	10/107
LED modules	10/111
AS-Interface modules	10/113
Electronic modules for ID key-operated switches	10/115
Enclosures	
General data	10/117
Empty enclosures	10/118
Pushbuttons and indicator lights in the enclosure	10/119
Pushbuttons and indicator lights in the enclosure for AS-Interface	10/123
Modules for enclosures	10/125
Two-hand operation consoles	10/129
Labels	
Insert labels	10/130
Label holders for labeling plates	10/133
Labeling plates	10/134
Labeling plates for enclosures	10/140
Labels for laser printers	10/143
Other labels	10/144
Accessories	
Protection/access protection	10/146
Actuators	10/150
Enclosures	10/153
Miscellaneous accessories	10/155
Standards and approvals	10/157 - 10/158

Sirius Signal Columns

Introduction	10/161 - 10/162
Technical Specifications	10/163
8WD42 signaling columns, 50 mm diameter and accessories	10/164 - 10/165
8WD44 signaling columns, 70 mm diameter and accessories	10/166 - 10/169
8WD53 beacons, 70 mm diameter	10/170
Dimensional Drawings	10/171 - 10/173

3SE2, 3SE3 Foot Switches

Introduction	10/159
Plastic and Metal Enclosures	10/160

Class 50 Standard Duty Control Stations

Introduction	10/174
Standard Duty Type 1 and 1B	10/175 - 10/179
Heavy Duty Type 4 Stations	10/180
Class 50 Accessories	10/181
Dimension Drawings	10/182

Class 51 NEMA Type 7/9 Hazardous Location Pilot Devices

Introduction	10/183
Pushbutton and Push-pull Operators	10/184
Indicator Lights	10/185
Push to Test/Illuminated Pushbutton Complete Units	10/186
Selector Switch Operators	10/187
Keyed Selector Switch Operators	10/188
Cam Selection Guide for Selector Switch	10/189
Stations and Enclosures	10/190
Accessories	10/191 - 10/193

Class 52 30.5mm Mounting Diameter Pilot Devices

Introduction	10/194
Momentary Push Button, Non-Illuminated	10/195 - 10/196
2 & 3 Position Push-Pull Mushroom Head Devices, Non-Illuminated	10/197 - 10/198
2 & 3 Position Push-Pull Mushroom Head Devices, Illuminated	10/199 - 10/200
2 Position Twist-to-Release Mushroom Head Devices, Non-Illuminated	10/201
2 Position Twist-to-Release Mushroom Head Devices, Illuminated	10/202
Indicator Light	10/203 - 10/204
Push Button & Push-to-Test, Illuminated	10/205 - 10/206
Push Button Mushroom Head Devices, Illuminated	10/207
Selector Switches, Illuminated	10/208
Selector Switch Short & Long Lever, Non-Illuminated	10/209 - 10/210
Keyed Selector Switch	10/211 - 10/212
Selector Push Button	10/214
Special Devices	10/215
Cam Selection Guide for Selector Switch, Keyed Selector Switch and Selector Pushbutton	10/216
Custom Selector Switch Designs	10/217
Accessories and Spare Parts	10/218 - 10/221
Dimensional Drawings	10/222 - 10/225

Class 52 30.5mm Enclosed Pushbutton Stations

Assembled Enclosures with Standard Devices	10/226 - 10/227
P30 Empty Enclosures Only	10/228
Enclosure Legend Plates	10/229
Enclosure Dimensions	10/230
Technical Specifications	10/231

Push Button Units and Indicator Lights

contents

16 mm mounting diameter, molded-plastic



3SB2

Page

Selection and ordering data

- 3SB22 complete units 10/7
- 3SB20 pushbuttons and lens assemblies 10/9
- 3SB2 holders, lampholders and contact blocks 10/11
- 3SB29 inserts, legend plates, and accessories 10/13

- Introduction 10/4
- Technical specifications 10/5
- Dimension drawings 10/20

22 mm mounting diameter, plastic black

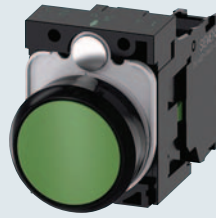

SIRIUS ACT – 3SU1

Page

Selection and ordering data

- Complete units 10/38
- Compact units 10/45
- Actuating and signaling Elements 10/47
- Accessories 10/105 – 10/115; 10/130 – 10/152

22 mm mounting diameter, plastic with metal matte front ring

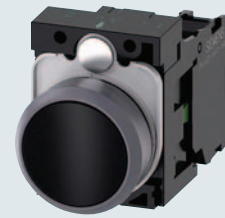

SIRIUS 3SB3, plastic round

Page

Selection and ordering data

- Complete units 10/59
- Compact units 10/65
- Actuating and signaling Elements 10/67
- Accessories 10/105 – 10/115; 10/130 – 10/152

22 mm mounting diameter, metal shiny

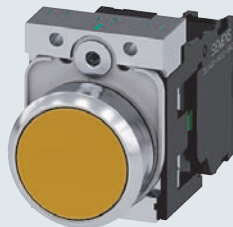

SIRIUS ACT – 3SU1

Page

Selection and ordering data

- Complete units 10/79
- Compact units 10/85
- Actuating and signaling Elements 10/88
- Accessories 10/105 – 10/115; 10/130 – 10/152

30 mm mounting diameter, metal matte



SIRIUS ACT – 3SU1

Page

Selection and ordering data

- Actuating and signaling Elements 10/98
- Accessories 10/125 – 10/128; 10/153 – 10/155

22mm enclosures and communication devices



SIRIUS ACT – 3SU1

Page

Selection and ordering data

- Empty enclosures 10/118
- Complete enclosure 10/119
- AS-Interface 10/123
- Accessories 10/125 – 10/128; 10/153 – 10/155
- Two-hand operation 10/129

Push Button Units and Indicator Lights

contents

SIRIUS signal columns, built-in signal beacons and foot switches

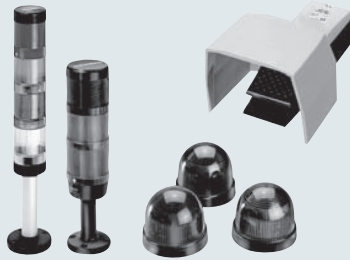

3SE2, 3SE3 Foot Switches Page

Selection and ordering data

- Plastic and metal enclosures 10/160

Lamp & LED version, enclosure diameters 50 and 70 mm

- 8WD42 selection & accessories 10/164
- 8WD44 selection & accessories 10/115
- 8WD53 beacons 10/119

Introduction	10/161
Technical Specifications	10/163
Dimension drawings	10/171

Standard duty control stations



Class 50 Page

Selection and ordering data

- Standard duty Type 1 and 1B 10/175
- Heavy duty Type 4 10/180
- Class 50 accessories 10/181

Introduction	10/174
Technical Specifications	10/174
Dimension drawings	10/182

Type 7/9 hazardous location — 3/4"–14 NPSM

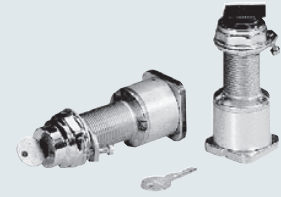

SIRIUS ACT – 3SU1 Page

Selection and ordering data

- Push pull complete units 10/184
- Pilot lights 10/185
- Selector switches 10/187
- Push to test/illuminated push buttons 10/186
- Cam selection guide 10/189
- Stations and enclosures 10/190
- Accessories 10/191

Introduction	10/183
Technical Specifications	10/183

NEMA 30.5 mm mounting diameter, corrosion resistant, watertight & oiltight



Class 52 Page

Selection and ordering data

- Momentary Push Button, Non-Illuminated 10/195-10/196
- 2 & 3 Position Push-Pull Mushroom Head Devices, Non-Illuminated 10/197-10/198
- 2 & 3 Position Push-Pull Mushroom Head Devices, Illuminated 10/199-10/200
- 2 Position Twist-to-Release Mushroom Head Devices, Non-Illuminated 10/201
- 2 Position Twist-to-Release Mushroom Head Devices, Illuminated 10/202
- Indicator Light 10/203-10/204

Introduction	10/143
Technical Specifications	10/178
Dimension drawings	10/169

Class 52 Page

Selection and ordering data

- Push Button & Push-to-Test, Illuminated 10/205-10/206
- Push Button Mushroom Head Devices, Illuminated 10/207
- Selector Switches, Illuminated 10/208
- Selector Switch Short & Long Lever, Non-Illuminated 10/209-10/210
- Keyed Selector Switch 10/211-10/212
- Selector Push Button 10/214

30.5 mm heavy duty control stations, Type 4/4X/12/13 encl.



Class 52 Page

Selection and ordering data

- Class 52 assembled stations with standard offerings 10/225
- P30 enclosures only 10/227
- Custom station order form 10/227
- Legend plates 10/228

3SB2, Mounting Diameter 16 mm

General data

Overview

The 3SB2 push buttons and indicator lights are provided for front plate mounting and rear connection with flat connectors. For use on printed circuit boards, contact blocks and lamp holders with solder pins are also available.

Standards

IEC 60947-1, EN 60947-1,
IEC 60947-5-1, EN 60947-5-1,
IEC 60947-5-5, EN 60947-5-5 for EMERGENCY-STOP mushroom push buttons.

Version with flat connector

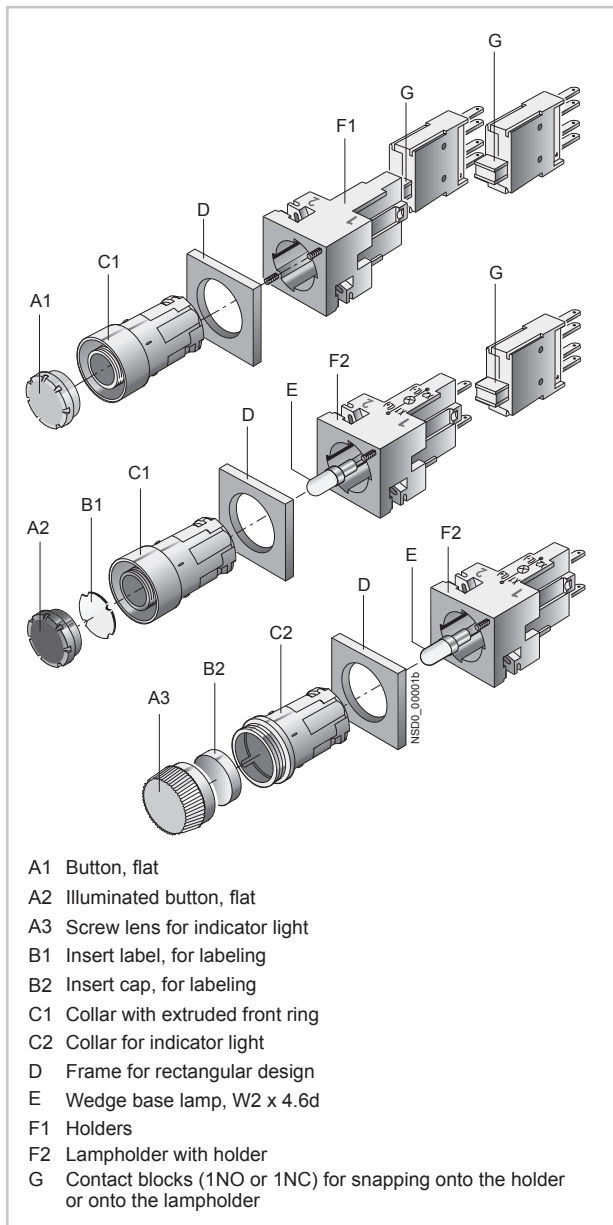

For PCB mounting

For use on printed circuit boards, special contact blocks and lamp holders for soldering into the printed circuit board are available. For this purpose, the contact blocks and lamp holders are fitted with 0.8 mm x 0.8 mm solder pins of length 3.5 mm.

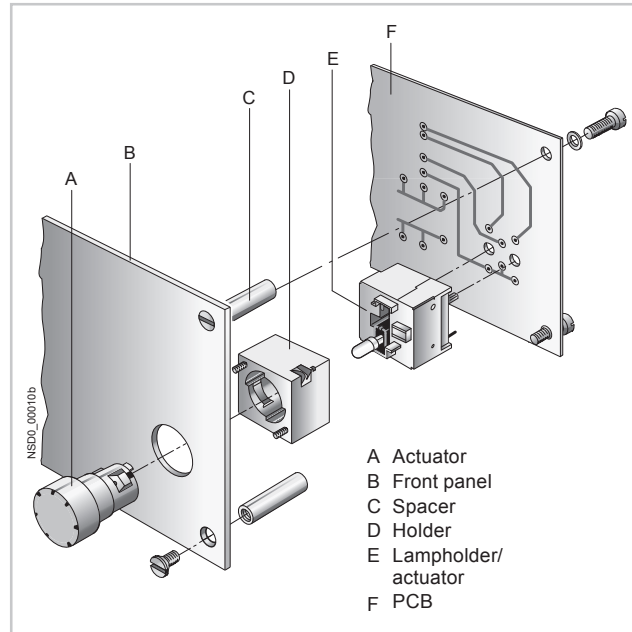

Connection methods



Flat connectors



Solder pin connections

The terminals are indicated in the corresponding tables by the symbols shown on blue backgrounds.

Application

The devices are climate-proof and suitable for marine applications.

Safety EMERGENCY-STOP push buttons according to ISO 13850

For controls according to IEC 60204-1 or EN 60204-1, the mushroom push buttons of the 3SB2 series are suitable for use as safety EMERGENCY-STOP push buttons.

Safety circuits

IEC 60947-5-1 and EN 60947-5-1 require positive opening, i.e. for the purposes of personal safety, the assured opening of NC contacts is expressly stipulated for the electrical equipment of machines in all safety circuits and marked according to IEC 60947-5-1 with the symbol ☞.

Category 4 according to EN 954-1 can be attained with the EMERGENCY-STOP mushroom push buttons if the corresponding failsafe evaluation units are selected and correctly installed, e.g. the 3TK28 safety relays or matching units from the ASIsafe, SIMATIC or SINUMERIK product ranges.

3SB2, Mounting Diameter 16 mm

General data

Technical specifications

Type	3SB2	
Contact blocks and lamp holders		
Standards	IEC 60947-5-1, EN 60947-5-1 IEC 60947-5-5, EN 60947-5-5	
Rated insulation voltage U_i	V	250
Conventional thermal current I_{th}	A	10
Rated operational current I_e at rated operational voltage U_e		
<ul style="list-style-type: none"> • Alternating current AC-12 - At $U_e = 24 \dots 230$ V 	A	10
<ul style="list-style-type: none"> • Alternating current AC-15 - At $U_e = 24 \dots 230$ V 	A	4
<ul style="list-style-type: none"> • Direct current DC-12 - At $U_e = 24$ V - At $U_e = 60$ V - At $U_e = 110$ V - At $U_e = 230$ V 	A	6 5 2.5 1
<ul style="list-style-type: none"> • Direct current DC-13 - At $U_e = 24$ V - At $U_e = 60$ V - At $U_e = 110$ V - At $U_e = 230$ V 	A	3 1.5 0.7 0.3
Contact stability		
• Test voltage/test current	5 V/1 mA	
Lamps		
• Bases	Wedge base W2× 4.6 d	
• Rated voltage	V	6, 12, 24, 30, 48, 60
• Rated power, max.	W	1
Short-circuit protection weld-free according to IEC 60947-5-1		
• DIAZED fuse links, utilization category gG	10 A TDz, 16 A Dz	
• Miniature circuit breaker with C characteristic according to IEC 60898	10 A	
Electrical endurance		
• For utilization category AC-15 with 3RT10 15 to 3RT10 26 contactors	10 × 10 ⁶ operating cycles	
Mechanical endurance		
	10 × 10 ⁶ operating cycles	
Degree of protection acc. to IEC 60529		
• Connection of contact blocks and lamp holders behind the front panel	IP00	
• Contact chambers of the contact blocks behind the front panel	IP40	
Finger-safe according to IEC 61140 and BGV A3		
	With voltages > 50 V AC or 120 V DC, insulation sleeves must be fitted to the unassigned tab connections.	
Data according to UL and CSA		
Rated voltage		
• Contact blocks	V	250 AC
• Indicator light (lamp with wedge base W2× 4.6 d)	V	60; 1 W
Uninterrupted current	A	5
Switching capacity	B 300, R 300	
Actuators and indicators		
Mechanical endurance		
• Push Buttons	10 × 10 ⁶ operating cycles	
• Actuators, rotary or maintained	3 × 10 ⁵ operating cycles	
• Illuminated push buttons	3 × 10 ⁶ operating cycles	
Climatic withstand capability		
	Climate-proof; suitable for marine applications	
Ambient temperature		
• During operation, non-illuminated devices and complete with LED	°C	-25 ... +70
• During operation, devices with incandescent lamp	°C	-25 ... +60
• During storage, transport	°C	-40 ... +80
Degree of protection acc. to IEC 60529		
• Actuators and indicators	IP65	
• Actuators and indicators with protective cap	IP67	
Protective measures		
• For mounting in metal front plates and enclosures	The actuators and lens assemblies must not be included in the protective measures. The protective measure "Total insulation" is retained.	
• For fitting into enclosures with total insulation		
Shock resistance acc. to IEC 60068-2-27		
• Shock amplitude	ms	≤ 50 g
• Shock duration		11
• Shock form		Half-sine

More technical information [see Reference manual "Commanding and Signaling Devices"](#).

3SB2, Mounting Diameter 16 mm

General data

Configuration

Design

Two design versions can be mounted:

- Round design: The 3SB2 push buttons and indicator lights are assembled with the modules – actuator, holder, contact block and lamp holder. Depending on the specific application, various versions can be assembled. Complete units are offered for the most commonly used applications.
- Square design: With square, black frames the round units can be given a square look. The frames are inserted underneath the round actuators. Further mounting is the same as for the round version.

Mounting and fixing:

Mounting dimensions according to EN 50007 (not applicable to EMERGENCY-STOP mushroom push buttons)

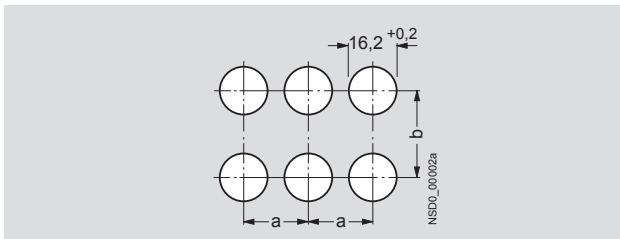

Minimum clearance	a	b
Round version	19	19
Square version without inscription label	21	21
Round and square version with inscription label	21	32
For 2 selector switches with 3 switch positions, maintained, side by side	21	21

For mounting, the actuator or the lens assembly is inserted from the front into the hole in the front plate. Four small nubs ensure a secure fitting in the hole. The holder is plugged on from the back and snaps automatically into place. The module is fixed to the holder with 2 screws so that it is immune to vibrations.

One or two contact blocks can be mounted on the holder. They are inserted into the holder with slide slots and held down with two snap brackets.

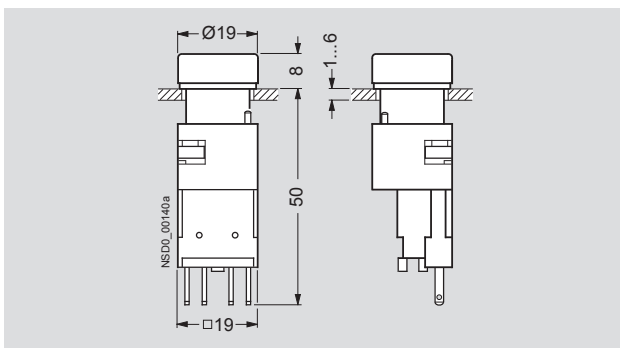

Push button (flat) with holder and contact block

If a command point is fitted with an indicator light or illuminated push button, a lamp socket with lamp holder must be used instead of a holder. It is suitable for incandescent lamps or LEDs with bases of type W2 × 4.6d.

For PCB mounting

The command point comprises the actuator – e.g. 3SB2 push button, illuminated push button or indicator light –, which is mounted in the front plate, and a contact block and a lamp holder which are soldered to the PCB. For this purpose, the contact blocks and lamp holders are fitted with 0.8 mm × 0.8 mm solder pins of length 3.5 mm.

Mounting and fixing:

Mounting dimensions according to EN 50007.

The actuators are mounted in the same way as 3SB2 front plate mounting devices.

The contact blocks and lamp holders are plugged into the printed circuit board by means of their solder pins and can be flow-soldered. After soldering, the devices must be flush with the board and perpendicular to it. The printed circuit board must be supported on spacing bolts so that it cannot sag or bend more than 0.1 mm.

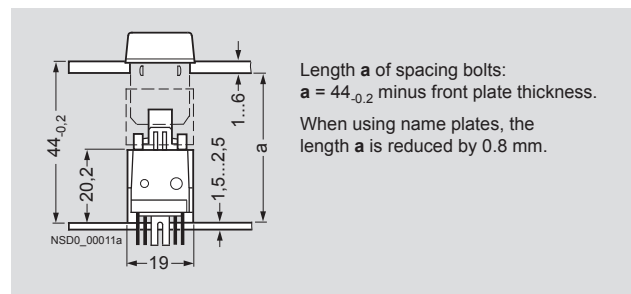

Illuminated push button with solder pin connection

To avoid bending the PCB when the control device is operated, sufficient spacing bolts must be provided as shown in the table below:

PCB thickness	Max. distance between spacing bolts
1.5 mm	80 mm
2.5 mm	150 mm
When using EMERGENCY-STOP push buttons	always 50 mm

These details are based on epoxy resin glass fiber mat.

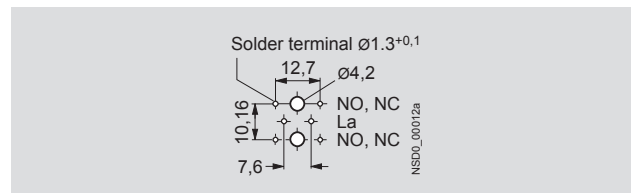



Solder pin spacing

3SB2, Mounting Diameter 16 mm

Complete units

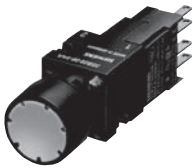
Selection and ordering data

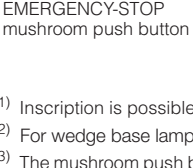
Version	Contact blocks	DT	Color of handle	Flat connectors	PS	
				Order No.		
 <p>Pushbutton with flat button</p>	Push buttons with flat button		1 NO	Black	3SB22 02-0AB01	1 unit
			1 NC	Black	3SB22 03-0AB01	1 unit
			1 NC	Red	3SB22 03-0AC01	1 unit
			1 NO	Yellow	3SB22 02-0AD01	1 unit
			1 NO	Green	3SB22 02-0AE01	1 unit
			1 NO	Blue	3SB22 02-0AF01	1 unit
			1 NO	White	3SB22 02-0AG01	1 unit
			1 NO	Clear ¹⁾	3SB22 02-0AH01	1 unit
	 <p>Illuminated push button with raised button</p>	Illuminated push buttons with flat button		1 NC	Red	3SB22 07-0AC01
		1 NO	Yellow ¹⁾	3SB22 06-0AD01	1 unit	
		1 NO	Green	3SB22 06-0AE01	1 unit	
		1 NO	Blue	3SB22 06-0AF01	1 unit	
		1 NO	Clear ¹⁾	3SB22 06-0AH01	1 unit	
 <p>Illuminated push button with raised button</p>	Illuminated push buttons with flat button		1 NC	Red	3SB22 27-0AC01	1 unit
			1 NO	Yellow ¹⁾	3SB22 26-0AD01	1 unit
			1 NO	Green	3SB22 26-0AE01	1 unit
			1 NO	Blue	3SB22 26-0AF01	1 unit
			1 NO	Clear ¹⁾	3SB22 26-0AH01	1 unit
 <p>EMERGENCY-STOP mushroom push button</p>	Push buttons with raised button		1 NO	Black	3SB22 02-0LB01	1 unit
			1 NC	Red	3SB22 03-0LC01	1 unit
			1 NO	Yellow	3SB22 02-0LD01	1 unit
			1 NO	Blue	3SB22 02-0LF01	1 unit
			1 NO	Clear ¹⁾	3SB22 02-0LH01	1 unit
	Illuminated push buttons with raised button		1 NC	Red	3SB22 07-0LC01	1 unit
			1 NO	Yellow ¹⁾	3SB22 06-0LD01	1 unit
			1 NO	Green	3SB22 06-0LE01	1 unit
			1 NO	Blue	3SB22 06-0LF01	1 unit
		1 NO	Clear ¹⁾	3SB22 06-0LH01	1 unit	
Illuminated push buttons with raised button		1 NC	Red	3SB22 27-0LC01	1 unit	
		1 NO	Yellow ¹⁾	3SB22 26-0LD01	1 unit	
		1 NO	Green	3SB22 26-0LE01	1 unit	
		1 NO	Blue	3SB22 26-0LF01	1 unit	
		1 NO	Clear ¹⁾	3SB22 26-0LH01	1 unit	
EMERGENCY-STOP mushroom push buttons acc. to ISO 13850, maintained³⁾		1 NC	Red	3SB22 03-1AC01	1 unit	
Latches automatically when pressed; unlatches by turning the mushroom head anticlockwise, with yellow name plate, with inscription "NOT-HALT"						

¹⁾ Inscription is possible by inserting a label.

²⁾ For wedge base lamps see "Accessories", page 10/18.

³⁾ The mushroom push button cannot be combined with 3SB29 02-0AB name plate or 3SB29 02-0AA single frame.

⁴⁾ Positive opening according to IEC 60947-5-1, Appendix K.

3SB2, Mounting Diameter 16 mm

Complete units



Selector switch

Version	Contact blocks	Color of handle	DT	Flat connectors	PS
Order No.					
Selector switches, 2 switch positions Switching sequence O-I, 62° operating angle, maintained 	1 NO	Black		3SB22 02-2AB01 3SB22 02-2AC01 3SB22 02-2AE01 3SB22 02-2AG01	1 unit
	1 NO	Red			1 unit
	1 NO	Green			1 unit
	1 NO	White			1 unit
Selector switches, 3 switch positions Switching sequence I-O-II, 2 × 62° operating angle, maintained 	1 NO, 1 NO	Black		3SB22 10-2DB01 3SB22 10-2DC01 3SB22 10-2DE01 3SB22 10-2DG01	1 unit
	1 NO, 1 NO	Red			1 unit
	1 NO, 1 NO	Green			1 unit
	1 NO, 1 NO	White			1 unit
Selector switches, 3 switch positions Switching sequence I-O-II, 2 × 50° operating angle, momentary, Spring return from left and right 	1 NO, 1 NO	Black		3SB22 10-2EB01 3SB22 10-2EC01 3SB22 10-2EE01 3SB22 10-2EG01	1 unit
	1 NO, 1 NO	Red			1 unit
	1 NO, 1 NO	Green			1 unit
	1 NO, 1 NO	White			1 unit



CES key-operated switch

Version	Contact blocks	Lock No.	Key removal position	DT	Flat connectors	PS
Order No.						
CES key-operated switches, 2 switch positions Switching sequence O-I, 62° operating angle, maintained 	1 NO	SB2	O		3SB22 02-4LA01 3SB22 02-4LB01	1 unit
	1 NO	SB2	O + I			1 unit
CES key-operated switches, 3 switch positions Switching sequence I-O-II, 2 × 62° operating angle, maintained 	1 NO, 1 NO	SB2	O		3SB22 10-4PA01 3SB22 10-4PB01	1 unit
	1 NO, 1 NO	SB2	I + O + II			1 unit
CES key-operated switches, 3 switch positions Switching sequence I-O-II, 2 × 50° operating angle, momentary, Spring return from left and right 	1 NO, 1 NO	SB2	O		3SB22 10-4QA01	1 unit



Indicator light



Version	Color of screw lens	DT	Flat connectors	PS
Order No.				
Indicator lights Lamp holder W2 x 4.6 d without lamp ¹⁾	Red		3SB22 04-6BC06 3SB22 04-6BD06 3SB22 04-6BE06 3SB22 04-6BG06 3SB22 04-6BH06	1 unit
	Yellow			1 unit
	Green			1 unit
	White			1 unit
	Clear			1 unit
Indicator lights Lamp holder W2 x 4.6 d with incandescent lamp 24 V	Red		3SB22 24-6BC06 3SB22 24-6BD06 3SB22 24-6BE06 3SB22 24-6BG06 3SB22 24-6BH06	1 unit
	Yellow			1 unit
	Green			1 unit
	White			1 unit
	Clear			1 unit

¹⁾ For wedge base lamps see "Accessories", page 10/18.

3SB2, Mounting Diameter 16 mm

Actuators and indicators

Selection and ordering data

Version	Color of handle	DT	Order No.	PS		
Push buttons						
 Push button and illuminated push button with flat button	Push buttons with flat button	Black Red Yellow Green Blue White Clear ¹⁾	3SB20 00-0AB01 3SB20 00-0AC01 3SB20 00-0AD01 3SB20 00-0AE01 3SB20 00-0AF01 3SB20 00-0AG01 3SB20 00-0AH01	1 unit 1 unit 1 unit 1 unit 1 unit 1 unit 1 unit		
	Illuminated push buttons with flat button	Red Yellow ¹⁾ Green Blue White Clear ¹⁾	3SB20 01-0AC01 3SB20 01-0AD01 3SB20 01-0AE01 3SB20 01-0AF01 3SB20 00-0AG01 3SB20 00-0AH01	1 unit 1 unit 1 unit 1 unit 1 unit 1 unit		
	 Push button and illuminated push button with raised button	Push buttons with raised button	Black Red Yellow Blue White Clear ¹⁾	3SB20 00-0LB01 3SB20 00-0LC01 3SB20 00-0LD01 3SB20 00-0LF01 3SB20 00-0LG01 3SB20 00-0LH01	1 unit 1 unit 1 unit 1 unit 1 unit 1 unit	
		Illuminated push buttons with raised button	Red Yellow ¹⁾ Green Blue Clear ¹⁾	3SB20 01-0LC01 3SB20 01-0LD01 3SB20 01-0LE01 3SB20 01-0LF01 3SB20 00-0LH01	1 unit 1 unit 1 unit 1 unit 1 unit	
		EMERGENCY-STOP mushroom push buttons acc. to ISO 13850, maintained²⁾ Latches automatically when pressed; unlatches by turning the mushroom head anticlockwise	Red		3SB20 00-1AC01	1 unit







¹⁾ Inscription is possible by inserting a label.

²⁾ The mushroom push button cannot be combined with 3SB29 02-0AB name plate or 3SB29 02-0AA single frame.

Version	Color of handle	DT	Order No.	PS
---------	-----------------	----	-----------	----

Selector switches



 Selector switch	Selector switches with 2 switch positions Switching sequence O-I, 62° operating angle, maintained		Black Red Green White	3SB20 00-2AB01 3SB20 00-2AC01 3SB20 00-2AE01 3SB20 00-2AG01	1 unit 1 unit 1 unit 1 unit
	Selector switches with 2 switch positions Switching sequence O-I, 50° operating angle, momentary, spring return from right		Black Red Green	3SB20 00-2BB01 3SB20 00-2BC01 3SB20 00-2BE01	1 unit 1 unit 1 unit
	Selector switches with 2 switch positions Switching sequence O-I, 90° operating angle, maintained		Black Red Green White	3SB20 00-2HB01 3SB20 00-2HC01 3SB20 00-2HE01 3SB20 00-2HG01	1 unit 1 unit 1 unit 1 unit
	Selector switches with 3 switch positions Switching sequence I-O-II, 2 x 62° operating angle, maintained		Black Red Green White	3SB20 00-2DB01 3SB20 00-2DC01 3SB20 00-2DE01 3SB20 00-2DG01	1 unit 1 unit 1 unit 1 unit
	Selector switches with 3 switch positions Switching sequence I-O-II, 2 x 50° operating angle, momentary, spring return from left and right		Black Red Green White	3SB20 00-2EB01 3SB20 00-2EC01 3SB20 00-2EE01 3SB20 00-2EG01	1 unit 1 unit 1 unit 1 unit
	Selector switches with 3 switch positions Switching sequence I-O-II, 2 x 90° operating angle, maintained		Black	3SB20 00-2JB01	1 unit

3SB2, Mounting Diameter 16 mm

Actuators and indicators

Key-operated switches



CES key-operated switch

Version	Lock No.	Key removal position	DT	Order No.	PS	
Key-operated switches						
<p>CES key-operated switches with 2 keys, 2 switch positions Switching sequence O-I, 62° operating angle, maintained</p> <p>CES key-operated switches with 2 keys, 2 switch positions Switching sequence O-I, 50° operating angle, momentary, spring return from right</p> <p>CES key-operated switches with 2 keys, 3 switch positions Switching sequence I-O-II, 2 x 62° operating angle, maintained</p> <p>CES key-operated switches with 2 keys, 3 switch positions Switching sequence I-O-II, 2 x 50° operating angle, momentary, spring return from left and right</p>			SB2	O+I O	3SB20 00-4LB01 3SB20 00-4LA01	1 unit 1 unit
				O	3SB20 00-4MA01	1 unit
				I+O+II O	3SB20 00-4PB01 3SB20 00-4PA01	1 unit 1 unit
				O	3SB20 00-4QA01	1 unit

Version	Color of screw lens	DT	Order No.	PS
Indicator lights				
<p>Indicator lights with concentric rings (inscription by inserting a cap is not possible)</p> <p>Indicator lights, smooth for inscription by inserting a cap¹⁾</p>	Red		3SB20 01-6BC06	1 unit
	Yellow		3SB20 01-6BD06	1 unit
	Green		3SB20 01-6BE06	1 unit
	Blue		3SB20 01-6BF06	1 unit
	White		3SB20 01-6BG06	1 unit
	Clear		3SB20 01-6BH06	1 unit
	Red		3SB20 01-6CC06	1 unit
	Yellow		3SB20 01-6CD06	1 unit
	Green		3SB20 01-6CE06	1 unit
	Blue		3SB20 01-6CF06	1 unit
Clear		3SB20 01-6CH06	1 unit	

¹⁾ Insert caps, see "Accessories", page 10/15

3SB2, Mounting Diameter 16 mm

Contact blocks and lampholders

Selection and ordering data

Version	Diagram	Operating travel <input type="checkbox"/> Contact closed <input type="checkbox"/> Contact open	DT	Flat connectors	PS
				Order No.	

Contact blocks and lamp holders with flat connectors 2 x 2.8 – 0.8 mm according to IEC 60760

Holders for fixing the actuator and the contact blocks



Holder

Holders for 2 contact blocks
 Inscription with identification number 1-2

3SB29 08-0AA 5 units

Lamp holders with holder for fixing the actuator and the contact blocks



Lamp holder

Lamp holders

W2 x 4.6 d
 without lamp

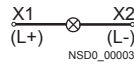

3SB23 04-2A 1 unit

Lamp holders

W2 x 4.6 d

- With 6 V incandescent lamp
- With 24 V incandescent lamp

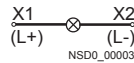

3SB23 04-2F 1 unit

3SB23 04-2H 1 unit

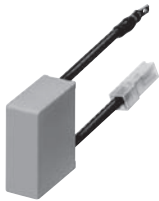

Voltage reducer

Voltage reducers¹⁾

For connecting the 3SB29 08-1AE lamp (48 V) to 230 V AC

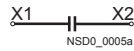

3SB24 04-3D 1 unit

Contact blocks for fixing in the holder or lamp holder



Contact block

Contact blocks with one contact²⁾

1 NO

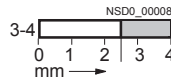

3SB24 04-0B 1 unit

1 NC ³⁾

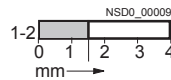

3SB24 04-0C 1 unit

¹⁾ Use fixpoint terminal according to IEC 60439-1.

²⁾ For plug-in and insulation sleeves see "Accessories", page 10/19.

³⁾ Positive opening according to IEC 60947-5-1, Appendix K.

3SB2, Mounting Diameter 16 mm

Contact blocks and lamp holders

Version	Diagram	Operating travel <input type="checkbox"/> Contact closed <input type="checkbox"/> Contact open	DT	Solder pin connections 	PS
---------	---------	--	----	--	----

Order No.

Contact blocks and lamp holders with solder pins



Holder

Holders for contact block with solder pins

For fixing the actuators in the front panel

Lamp holders

Wedge base W2 x 4.6 d¹⁾



3SB29 08-0AB 5 units

3SB24 55-2A 1 unit



Contact block with solder pins

Contact blocks

1 NO

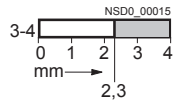

3SB24 55-0B 1 unit

1 NC

⊖²⁾

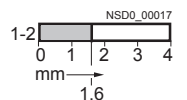

3SB24 55-0C 1 unit

1 NO + 1 NC

⊖²⁾

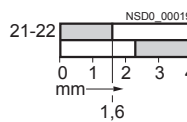

3SB24 55-0J 1 unit

1 NO + 1 NO

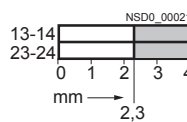

3SB24 55-0E 1 unit

1 NC + 1 NC

⊖²⁾

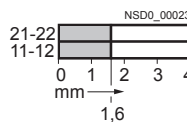

3SB24 55-0F 1 unit

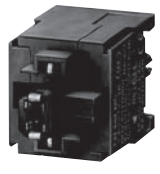

Contact block and lamp holder with solder pins

Contact blocks and lamp holders, wedge base W2 x 4.6 d¹⁾

1 NO

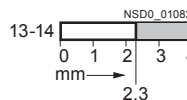

3SB24 55-1B 1 unit

1 NC

⊖²⁾

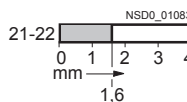

3SB24 55-1C 1 unit

1 NO + 1 NC

⊖²⁾

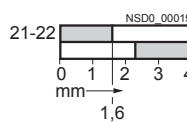

3SB24 55-1J 1 unit

1 NO + 1 NO

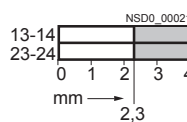

3SB24 55-1E 1 unit

1 NC + 1 NC

⊖²⁾

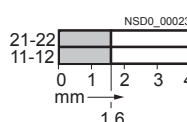

3SB24 55-1F 1 unit

¹⁾ The lamp is not included in the scope of supply.

3SB2, Mounting Diameter 16 mm

Insert labels and insert caps

Overview

Clear push buttons, illuminated push buttons and indicator lights can be fitted with insert labels and caps for identification purposes.

The insert labels and insert caps are made of a milky-transparent plastic with black lettering; they can be fitted in any 90° angle.

Inscriptions

The inscriptions have upper case initial letters. Graphic symbols, including those not listed in the catalog, are according to ISO 7000 or IEC 60417.

For customized inscriptions see "Options".

Selection and ordering data

Inscription/Symbol	Symbol No.	DT	Insert labels For push buttons and illuminated push buttons, flat Order No.	PS
--------------------	------------	----	---	----

For self-inscription



Blank			3SB29 01-4AA	10 units
-------	--	--	---------------------	----------

With inscription



On			3SB29 01-4EB	10 units
Start			3SB29 01-4EK	10 units
Stop			3SB29 01-4EL	10 units
Reset			3SB29 01-4EM	10 units
Test			3SB29 01-4EN	10 units
0			3SB29 01-4RA	10 units
1			3SB29 01-4RB	10 units
2			3SB29 01-4RC	10 units
3			3SB29 01-4RD	10 units
4			3SB29 01-4RE	10 units
5			3SB29 01-4RF	10 units
6			3SB29 01-4RG	10 units
7			3SB29 01-4RH	10 units
8			3SB29 01-4RJ	10 units
9			3SB29 01-4RK	10 units























Graphic ON/OFF symbols



O (Off)		5008 IEC	3SB29 01-4MB	10 units
I (On)		5007 IEC	3SB29 01-4MC	10 units
II (On)		--	3SB29 01-4MD	10 units















3SB2, Mounting Diameter 16 mm

Insert labels and insert caps

Inscription/Symbol	Symbol No.	DT	Insert labels For push buttons and illuminated push buttons, flat Order No.	PS
Graphic equipment symbols				
 Electric motor	 0011 ISO		3SB29 01-4PA	10 units
Horn	 5014 IEC		3SB29 01-4PB	10 units
Pump	 0134 ISO		3SB29 01-4PD	10 units
Coolant pump	 0355 ISO		3SB29 01-4PE	10 units
Graphic motion symbols				
 Motion in direction of arrow (straight)	 5022 IEC		3SB29 01-4NA	10 units
Motion in direction of arrow (diagonal)	 --		3SB29 01-4NB	10 units
Clockwise rotation	 0004 ISO		3SB29 01-4NC	10 units
Anticlockwise rotation	 --		3SB29 01-4ND	10 units
Fast motion	 0266 ISO		3SB29 01-4NE	10 units
Increase (plus)	 5005 IEC		3SB29 01-4NG	10 units
Decrease (minus)	 5006 IEC		3SB29 01-4MC	10 units
Graphic control symbols				
 Clamp	 --		3SB29 01-4QB	10 units
Release	 --		3SB29 01-4QC	10 units
Brake off	 0021 ISO		3SB29 01-4QE	10 units
Lock	 0022 ISO		3SB29 01-4QF	10 units
Unlock	 0023 ISO		3SB29 01-4QG	10 units
On/Off, momentary contact	 5011 IEC		3SB29 01-4QJ	10 units
Manual operation	 0096 ISO		3SB29 01-4QK	10 units
Automatic sequence	 0017 ISO		3SB29 01-4QL	10 units
Customized inscriptions				
 Any inscription 1 line of text with up to 6 characters of 3 mm in height. Please add the appropriate order code to the Order No. and specify the line of text required.			3SB29 01-4AZ K0Y K1Y or K2Y K5Y	1 unit 1 unit 1 unit
Other graphic symbols Please add the order code "K3Y" to the Order No. and specify the serial number and the applied standard (ISO 7000 or IEC 60417).			3SB29 01-4AZ K3Y	1 unit
Any inscription or symbol Please add the order code "K9Y" to the Order No. and specify the inscription or the symbol required.			3SB29 01-4AZ K9Y	1 unit







3SB2, Mounting Diameter 16 mm

Insert labels and insert caps

Inscription/Symbol	Symbol No.	DT	Insert caps For push buttons and illuminated push buttons, raised Order No.	PS
For self-inscription				
 Blank			3SB29 01-5AA	10 units
With inscription				
 On			3SB29 01-5EB	10 units
	0		3SB29 01-5RA	10 units
	1		3SB29 01-5RB	10 units
	2		3SB29 01-5RC	10 units
	3		3SB29 01-5RD	10 units
	4		3SB29 01-5RE	10 units
	5		3SB29 01-5RF	10 units
	6		3SB29 01-5RG	10 units
	7		3SB29 01-5RH	10 units
	8		3SB29 01-5RJ	10 units
	9		3SB29 01-5RK	10 units
Graphic ON/OFF symbols				
 O (Off)		 5008 IEC	3SB29 01-5MB	10 units
I (On)		 5007 IEC	3SB29 01-5MC	10 units
II (On)		 --	3SB29 01-5MD	10 units
Graphic motion symbols				
 Motion in direction of arrow		 5022 IEC	3SB29 01-5NA	10 units
Motion in direction of arrow		 --	3SB29 01-5NB	10 units
Increase (plus)		 5005 IEC	3SB29 01-5NG	10 units
Decrease (minus)		 5006 IEC	3SB29 01-5MC	10 units
Graphic control symbols				
 Clamp		 --	3SB29 01-5QB	10 units
Release		 --	3SB29 01-5QC	10 units
Customized inscriptions				
 Any inscription 1 line of text with up to 6 characters of 3 mm in height. Please add the appropriate order code to the Order No. and specify the line of text required.			3SB29 01-5AZ K0Y K1Y or K2Y K5Y	1 unit 1 unit 1 unit
Other graphic symbols Please add the order code "K3Y" to the Order No. and specify the serial number and the applied standard (ISO 7000 or IEC 60417).			3SB29 01-5AZ K3Y	1 unit
Any inscription or symbol Please add the order code "K9Y" to the Order No. and specify the inscription or the symbol required.			3SB29 01-5AZ K9Y	1 unit

3SB2, Mounting Diameter 16 mm

Insert labels and insert caps

Inscription/Symbol	Symbol No.	DT	Insert caps For indicator lights Order No.	PS
For self-inscription				
 Blank			3SB29 01-7AA	10 units
Graphic symbols				
 Pump		0134 ISO	3SB29 01-7PD	10 units
 Manual operation		0096 ISO	3SB29 01-7QK	10 units
Customized inscriptions				
	Any inscription 1 line of text with up to 6 characters of 3 mm in height. Please add the appropriate order code to the Order No. and specify the line of text required.		3SB29 01-7AZ K0Y K1Y or K2Y K5Y	1 unit 1 unit 1 unit
	Other graphic symbols Please add the order code " K3Y " to the Order No. and specify the serial number and the applied standard (ISO 7000 or IEC 60417).		3SB29 01-7AZ K3Y	1 unit
	Any inscription or symbol Please add the order code " K9Y " to the Order No. and specify the inscription or the symbol required.		3SB29 01-7AZ K9Y	1 unit

Options

Customized inscriptions

Labels and caps can be inscribed with text and symbols not listed in the ordering data. Append the following codes to the Order No.:

- Text line in upper/lower case, always upper case for beginning of line (e.g. "Lift"): **K0Y**
- Text line in upper case (e.g. "LIFT"): **K1Y**
- Text line in lower case (e.g. "lift"): **K2Y**
- Text line in upper/lower case, all words begin with upper case letters (e.g. "Lift"): **K5Y**
- Symbol with number according to ISO 7000 or IEC 60417: **K3Y**
- Any inscription or symbols according to order form supplement: **K9Y**

When ordering, specify the required inscription in plain text in addition to the order number and order code. In the case of special inscriptions with words in languages other than German, give the exact spelling and specify the language.

One line with up to 6 characters with 3 mm letter height is possible for the inscription (see [ordering example 1](#)).

Symbols can also be ordered with numbers according to ISO 7000 or IEC 60417 (see [ordering examples 2 and 3](#)).

For special symbols (order code K9Y), a CAD drawing in DXF format can be submitted.

Ordering example 1

3SB29 01-4AZ
K1Y
Z = pump

Ordering example 2

3SB29 01-4AZ
K3Y
Z = 5008 IEC

Ordering example 3

3SB29 01-4AZ
K3Y
Z = 1118 ISO

3SB2, Mounting Diameter 16 mm

Name plates

Overview

The name plates consist of a black plastic label holder and an inscription label (silver with black print) for sticking in place.

Note mounting dimensions!





Inscriptions

The inscriptions (also special inscriptions) are lower case with upper case initial letters. Graphic symbols, including those not listed in the catalog, are according to ISO 7000 or IEC 60417.

Selection and ordering data

Inscription/Symbol	Symbol No.	DT	Order No.	PS
--------------------	------------	----	-----------	----

Inscription labels, self-adhesive, 9.5 mm x 18.5 mm

	Blank		3SB29 01-2AA	10 units	
	On		3SB29 01-2EB	10 units	
	Off		3SB29 01-2EC	10 units	
	Start		3SB29 01-2EL	10 units	
	Reset		3SB29 01-2EM	10 units	
	Fault		3SB29 01-2EW	10 units	
	Hand Auto		3SB29 01-2BA	10 units	
	Manual 0 Auto		3SB29 01-2BE	10 units	
	Man 0 Auto		3SB29 01-2ET	10 units	
Graphic symbols					
	O (Off)		5008 IEC	3SB29 01-2MB	1 unit
	I (On)		5007 IEC	3SB29 01-2MC	1 unit
	O I (horizontal)		--	3SB29 01-2MF	1 unit
	Motion in direction of arrow		5002 IEC	3SB29 01-2NA	1 unit
Customized inscriptions or symbols (see Options)				3SB29 01-2XZ	
				K0Y	1 unit
				K1Y, K2Y or K3Y	1 unit
				K5Y	1 unit
				K9Y	1 unit

Label holders

	Label holders for inscription labels The label holders must not be used with the 3SB2...-1AC01 EMERGENCY-STOP mushroom push button.		3SB29 02-0AB	1 unit
---	---	--	---------------------	--------

Options

Customized inscriptions

The labels can be inscribed with text and symbols not listed in the ordering data. Append the following codes to the Order No.:

- Text line(s) in upper/lower case, upper case always for beginning of line (e.g. "Lift off"): **K0Y**
- Text line(s) in upper case (e.g. "LIFT OFF"): **K1Y**
- Text line(s) in lower case (e.g. "lift off"): **K2Y**
- Text line(s) in upper/lower case, all words begin with upper case letters (e.g. "Lift Off"): **K5Y**
- Symbol with number according to ISO 7000 or IEC 60417: **K3Y**
- Any inscription or symbols according to order form supplement: **K9Y**

When ordering, specify the required inscription in plain text in addition to the order number and order code. In the case of special inscriptions with words in languages other than German, give the exact spelling and specify the language.

Two lines of 11 characters are permitted with 4 mm letter height (1 line) or 3 mm (2-line).

Symbols can also be ordered with numbers according to ISO 7000 or IEC 60417 (see ordering example).

For special symbols (order code K9Y), a CAD drawing in DXF format can be submitted.











Ordering example

3SB29 01-2XZ
K3Y
Z = 1118 ISO

3SB2, Mounting Diameter 16 mm

Mounting parts and components

Selection and ordering data

Version	Lamp voltage	Color	DT	Order No.	PS
V					
Buttons and lenses¹⁾					
 3SB29 10-0AF	Buttons, flat For push buttons	Black		3SB29 10-0AB	1 unit
		Red		3SB29 10-0AC	1 unit
		Yellow		3SB29 10-0AD	1 unit
		Green		3SB29 10-0AE	1 unit
		Blue		3SB29 10-0AF	1 unit
		White		3SB29 10-0AG	1 unit
		Clear		3SB29 10-0AH	1 unit
 3SB29 10-0CF	Buttons, flat For illuminated push buttons	Red		3SB29 10-0CC	1 unit
		Yellow		3SB29 10-0CD	1 unit
		Green		3SB29 10-0CE	1 unit
		Blue		3SB29 10-0CF	1 unit
		White		3SB29 10-0AG	1 unit
		Clear		3SB29 10-0AH	1 unit
		 3SB29 10-0BD	Buttons, raised For push buttons	Black	
Red				3SB29 10-0BC	1 unit
Yellow				3SB29 10-0BD	1 unit
Clear				3SB29 10-0BH	1 unit
 3SB29 10-0DD	Buttons, raised For illuminated push buttons	Red		3SB29 10-0DC	1 unit
		Yellow		3SB29 10-0DD	1 unit
		Clear		3SB29 10-0BH	1 unit
 3SB29 10-1AD	Screw lenses With concentric rings	Red		3SB29 10-1AC	1 unit
		Yellow		3SB29 10-1AD	1 unit
		Green		3SB29 10-1AE	1 unit
		Blue		3SB29 10-1AF	1 unit
		White		3SB29 10-1AG	1 unit
		Clear		3SB29 10-1AH	1 unit
 3SB29 10-1BE	Screw lenses Smooth, for inscription with insert cap	Red		3SB29 10-1BC	1 unit
		Yellow		3SB29 10-1BD	1 unit
		Green		3SB29 10-1BE	1 unit
		Blue		3SB29 10-1BF	1 unit
		Clear		3SB29 10-1BH	1 unit
Key for actuators					
 3SB29 08-2AJ	Keys For CES key-operated switch, lock No. SB2				
Lamps, wedge bases²⁾					
 3SB29 08-1AE	Incandescent lamps Wedge base W2 × 4.6 d, 1.0 W	AC/DC	Clear	3SB29 08-1AA	1 unit
		6		3SB29 08-1AB	1 unit
		12		3SB29 08-1AC	1 unit
		24		3SB29 08-1AD	1 unit
		30		3SB29 08-1AE	1 unit
		48		3SB29 08-1AF	1 unit
		60		3SB29 08-1AF	1 unit
 3SB39 01-1SB	LED lamps, super-bright Wedge base W2 × 4.6 d	24 AC/DC	Red	3SB39 01-1SB	1 unit
			Yellow	3SB39 01-1RB	1 unit
			Green	3SB39 01-1TB	1 unit
			White	3SB39 01-1UB	1 unit
			Blue	3SB29 08-1BD	1 unit
 3SB29 08-1BD		28 AC/DC	Red	3SB39 01-1SE	1 unit
			Yellow	3SB39 01-1RE	1 unit
			Green	3SB39 01-1TE	1 unit
			White	3SB39 01-1UE	1 unit
			Blue	3SB39 01-1VE	1 unit
 3SB29 08-1AB	Lamp extractors For lamps with bases W2 × 4.6 d			3SB29 08-2AB	1 unit

¹⁾ Included in the scope of supply of actuators or indicator lights.

²⁾ Included in the scope of supply of some complete units.

3SB2, Mounting Diameter 16 mm

Mounting parts and components

Version	DT	Order No.	PS
Accessories for command points			
	Single frames for square design ¹⁾	3SB29 02-0AA	1 unit
3SB29 02-0AA			
	Name plates, yellow, Ø 50 mm As backing plate for EMERGENCY-STOP, self-adhesive		
	<ul style="list-style-type: none"> • Blank • With German inscription "NOT-HALT" • With German inscription "NOT-AUS" 	3SB29 08-2AF 3SB29 08-2AG 3SB29 08-2AK	1 unit 1 unit 1 unit
3SB29 08-2AG			
	Blanking plugs Black plastic (degree of protection IP65)	3SB29 08-3AA	1 unit
3SB29 08-3AA			
	Protective caps, clear Silicone, for push buttons with flat and raised button	3SB29 08-3AB	1 unit
3SB29 08-1			
Flat connectors			
	Plug-in sleeves For flat connectors 2.8 × 0.8 mm, cross-section 0.5 ... 1.5 mm ²	3SB29 08-8AA	1 unit
3SB29 08-8AA			
	Insulation sleeves For flat connectors, connection from the front	3SB29 08-8AB	1 unit
3SB29 08-8AB			
	Complete connectors²⁾ For connecting contact blocks and lamp holders (up to 10 connections). Guaranteed finger-safe acc. to IEC 61140 and BGV A3.	3SB29 08-8AD	1 unit
3SB29 08-8AD			
	Plug-in sleeves For flat connectors 2.8 × 0.8 mm, with locating spring for maintained in complete connector	3SB29 08-8AE	250 units
3SB29 08-8AE			
Tools			
	Dismantling tools For holders and lamp holders with holder	3SB29 08-2AA	1 unit
3SB29 08-2AA			
	Mounting tools For buttons and screw lenses	3SB29 08-2AC	1 unit
3SB29 08-2AC			

¹⁾ Not suitable for EMERGENCY-STOP mushroom push buttons.

²⁾ Required 3SB29 08-8AE plug-in sleeves for flat connectors 2.8 × 0.8 mm are not included in the scope of supply.

3SB2, Mounting Diameter 16 mm

Dimension drawings (mm)

Actuators

Pushbutton or illuminated pushbutton with flat button

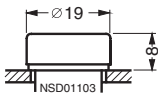

Pushbutton or illuminated pushbutton with raised button

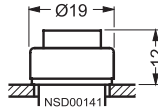

Selector switch

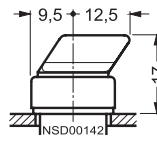

CES key-operated switch

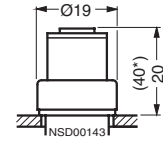

* with key

EMERGENCY-STOP mushroom pushbutton

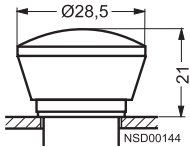

Indicator light

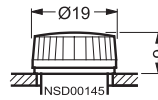

Contact blocks with push-on connection

Pushbutton and contact block with holder for frontplate mounting

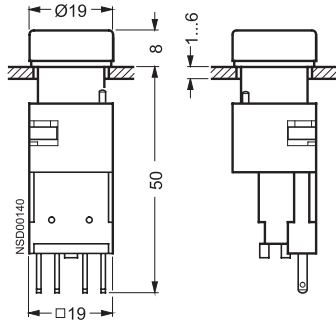

3SB2, Mounting Diameter 16 mm

Dimension drawings (mm)

Contact blocks with soldering pins for use on printed circuit boards

Illuminated pushbutton unit
with contact block and lamp-
holder with solder pins

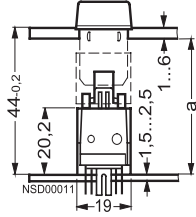

Length **a** of spacers: $a = 44^{-0.2}$
minus front plate thickness.
When using backing plates, the length **a** is
reduced by 0.8 mm.
To avoid bending of the PCB when the actuator is
operated, sufficient spacers must be provided
spaced as shown in the table below:

Maximum PCB thickness	Max. distance between spacers
1.5 mm	80 mm
2.5 mm	150 mm
When using EMERGENCY-STOP actuators	generally 50 mm

(These details are based on epoxy resin glass fibre mat.)

Solder pin spacing

Solder terminal $\varnothing 1.3^{+0.1}$

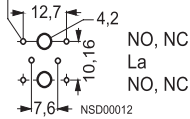

Mounting dimensions

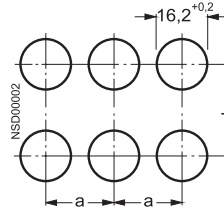

Minimum clearance	a	b
Round design	19	19
Square design without inscription plate	21	21
Round and square designs with inscription plates	21	32
For 2 selector switches and 3 switching positions, maintained contact, side by side	21	21

Accessories

Complete connector

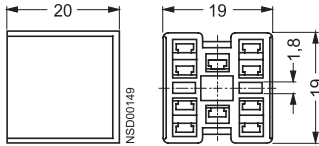

SIRUS ACT 3SU Series

Overview

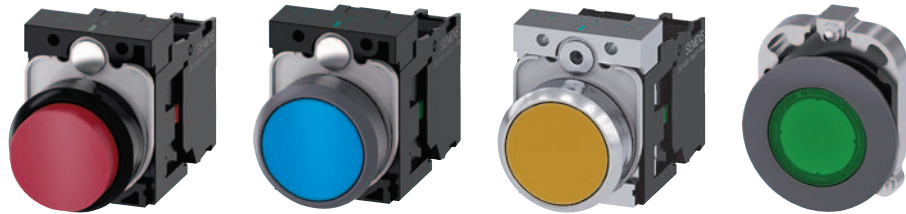

	3SU1.0	3SU1.3	3SU1.5	3SU1.6
Pushbuttons and indicator lights				
Designs				
Nominal diameter	22 mm	22 mm	22 mm	30 mm
Version	Plastic	Plastic with metal front ring, matte	Metal, shiny	Metal, matte, flat
Actuators				
Pushbuttons	✓	✓	✓	✓
Illuminated pushbuttons	✓	✓	✓	✓
Mushroom pushbuttons	✓	✓	✓	--
EMERGENCY STOP mushroom pushbuttons	✓	✓	✓	--
Selector switches	✓	✓	✓	✓
Key-operated switches	✓	✓	✓	✓
Special actuators				
Twin pushbuttons	✓	✓	✓	--
Coordinate switches	✓	✓	✓	--
Toggle switches	✓	✓	✓	--
Sensor switches	✓	✓	--	--
ID key-operated switches	✓	✓	--	--
Pushbuttons with extended stroke	✓	✓	✓	--
Potentiometers	✓	✓	✓	--
Indicators				
Indicator lights	✓	✓	✓	✓
Acoustic signaling devices	✓	✓	✓	--
Contact modules				
Single-pole	✓	✓	✓	✓
Two-pole	✓	✓	✓	✓
LED modules				
With integrated LED	✓	✓	✓	✓
Connections				
Screw terminals	✓	✓	✓	✓
Spring-type terminals	✓	✓	✓	✓
Solder pins	✓	✓	✓	✓
AS-Interface	✓	✓	✓	✓
IO-Link	✓	✓	✓	✓

✓ Standard
 -- Not available

Note:

Safety characteristics (see Appendix on page 10/157).

SIRIUS ACT 3SU Series

Overview



	3SU18	3SU18
	Enclosures	Two-hand operation consoles
Enclosures		
Plastic	✓	✓
Metal	✓	✓
Actuators		
Pushbuttons	✓	✓
Illuminated pushbuttons	✓	✓
Mushroom pushbuttons	✓	✓
EMERGENCY STOP mushroom pushbuttons	✓	✓
Selector switches	✓	✓
Key-operated switches	✓	✓
Indicators		
Indicator lights	✓	☐
Acoustic signaling devices	✓	☐
Contact modules		
Single-pole	✓	✓
Two-pole	--	✓
Connections		
Screw terminals	✓	✓
Spring-type terminals	✓	☐
Plug-in connection	☐	☐
AS-Interface	✓	☐

- ✓ Standard
- Not available
- ☐ Optional

AS-Interface solutions

Pushbuttons and indicator lights of the SIRIUS ACT series can be connected to the AS-Interface communication system quickly and easily with the help of various solutions.

For AS-Interface solutions see [catalog IK PI "Industrial Communication SIMATIC NET"](#).

AS-Interface EMERGENCY STOP according to ISO 13850

Using special modules, EMERGENCY STOP devices according to ISO 13850 can be directly connected through the standard AS-Interface with safety-related communication ([see page 10/113](#)).

AS-Interface enclosures

Enclosures with standard fittings are listed in this catalog. For customized enclosures, use the SIRIUS ACT Configurator to select the elements for equipping ([see page 10/123](#)).

PROFINET solutions

SIRIUS ACT devices will be equipped in future with a direct communication interface to PROFINET and PROFIsafe.

RFID authentication solutions

Groups of employees or individuals can be authenticated by means of the ID key-operated switch. Color-coded keys for easy distinction between users and flexible in application thanks to four function stages.

SIRIUS ACT 3SU Series

General data

Overview



SIRIUS ACT pushbuttons and indicator lights

SIRIUS ACT – commanding and signaling

SIRIUS ACT is a modular system of pushbuttons and indicator lights for front plate mounting and rear-mounted electrical modules.

Extensive portfolio

- Customized variants, e.g. special tumbler arrangements, labeling, equipped enclosures
- Communication-enabled thanks to direct interfacing to AS-Interface, IO-Link or PROFINET

Diverse possible applications

- National and international approvals
- Many trade approvals
- Short delivery times thanks to global availability

Standards

- IEC 60947-1, EN 60947-1
- IEC 60947-5-1, EN 60947-5-1
- IEC 60947-5-5, EN 60947-5-5 for EMERGENCY STOP devices

Further information

Home page, see www.siemens.com/sirius-act
 Industry Mall, see www.siemens.com/product?3SU1
 Configurator, see www.siemens.com/sirius-act/configurator
 Conversion tool, see www.siemens.com/sirius/conversion-tool
 Manual, see <https://support.industry.siemens.com/cs/ww/en/view/107542462>

Configurator



- Fast, simple selection by intuitive navigation through clearly-organized menus using drag & drop
- Image preview of selected components
- Inscription of pushbuttons and labeling plates using the interactive inscription tool
- Once created, a configuration can be ordered as often as required using the customer-specific article number and the CIN (Configuration Identification Number)
- Everything at a glance: Product data sheets, certificates, dimensional drawings, list prices, inscription tool

Benefits

Design

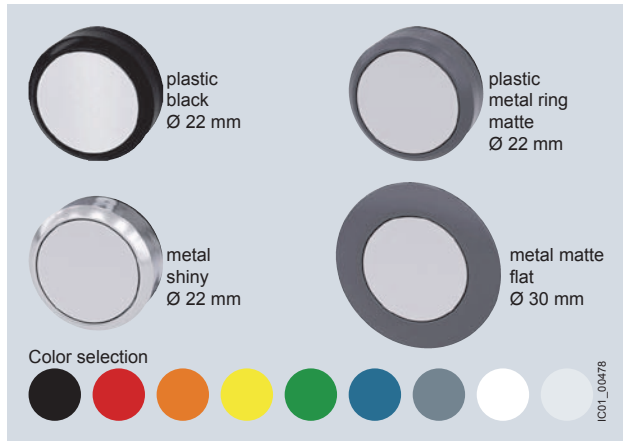

SIRIUS ACT is available in four design lines.

Ruggedness



- Degree of protection IP66, IP67, IP69 (IP69K)

IP66

6 = Protection against the ingress of dust

6 = Protection against powerful splash-water

IP67

6 = Protection against the ingress of dust

7 = Protection against temporary immersion

IP69 (IP69K)

6 = Protection against the ingress of dust

9/9K = Protection against water in high-pressure cleaning (approx. 80 bar) and high water jet temperatures (approx. 80 °C)

- Service life of 100 000 hours thanks to use of LEDs
- Media resistance (chemicals) thanks to solid stainless steel and high-grade plastics
- Mechanical endurance of 10×10^6 switching cycles
- Suitable for use in extreme environments
- Reliable, friction-locked fixing with just one screw
- Design stability according to use
- Simple geometry for mounting holes

Communication



- Direct connection of the enclosure to AS-Interface or IO-Link
- Direct connection in the control cabinet to PROFINET, IO-Link or AS-Interface
- Can be integrated easily via the TIA Portal

Easy handling

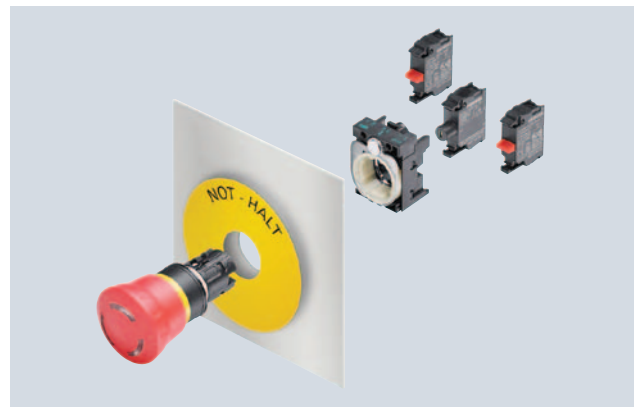

- Self-holding function of the actuator when mounting
- Twist prevention integrated into patented holder design
- Stackable contact modules
- Self-explanatory and fast installation using one hand
- Components can be mounted with holder removed
- No special tools required, simple size 2 screwdriver (cross-tip DIN ISO 87641PZD1, flat-head DIN ISO 2380-1 A/B 1x4.5) is sufficient

SIRIUS ACT 3SU Series

General data

Mounting dimensions

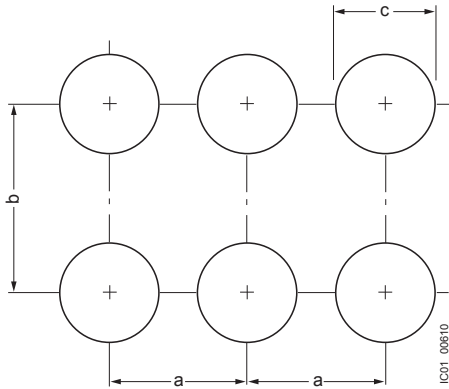

Versions

SIRIUS ACT is a modular system of pushbuttons and indicator lights with which customized variants can be configured flexibly.

One command point comprises:

- An actuating or signaling element in front of the control panel
- A holder for securing behind the control panel
- Up to six contact modules and/or one LED module (mounted onto the holder), single-pole contacts can be stacked
- A comprehensive range of accessories for inscription/markings

Complete units

Complete units made up of an actuating or signaling element, holder and contact modules and/or LED modules are offered for the most frequent application cases. The electrical parts are integrated and only have to be wired.

	Minimum clearance		
	a	b	c
	mm	mm	mm
22 mm, plastic with metal front ring, matte			
3-slot holder	30	40	22.3 ^{+0.4}
4-slot holder	40	40	22.3 ^{+0.4}
30 mm, metal, matte			
3-slot holder	40	45	30.5 ^{+0.5}

Compact units

Signaling devices, sensor switches, and pushbuttons with extended stroke are available as compact units. The electronic circuitry is already integrated in these devices, i.e. it is not necessary to snap on a contact or LED module.

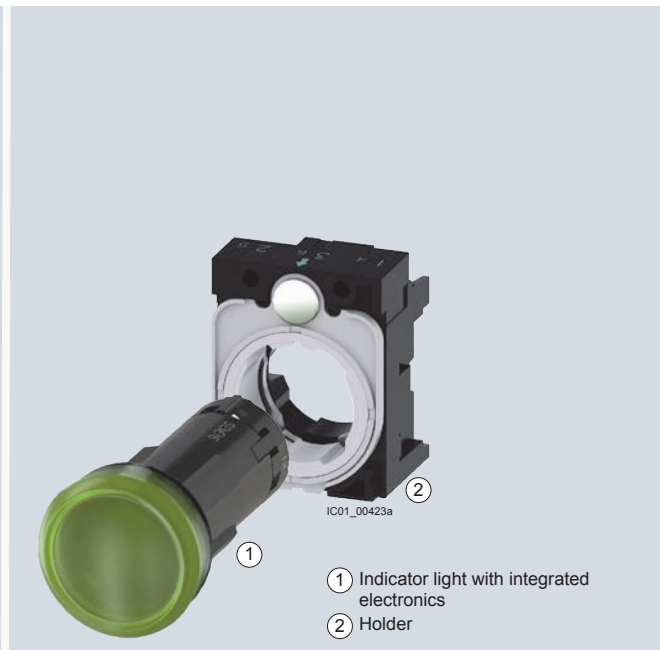
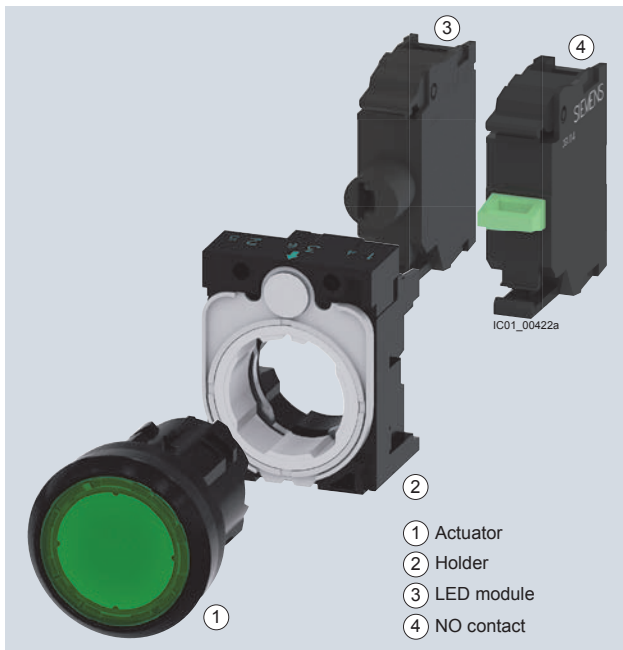

Complete units	Pages	Compact units	Pages
Plastic, black	10/38	Plastic, black	10/45
Plastic with metal front ring, matte	10/59	Plastic with metal front ring, matte	10/65
Metal, shiny	10/79	Metal, shiny	10/86

Actuating and signaling elements

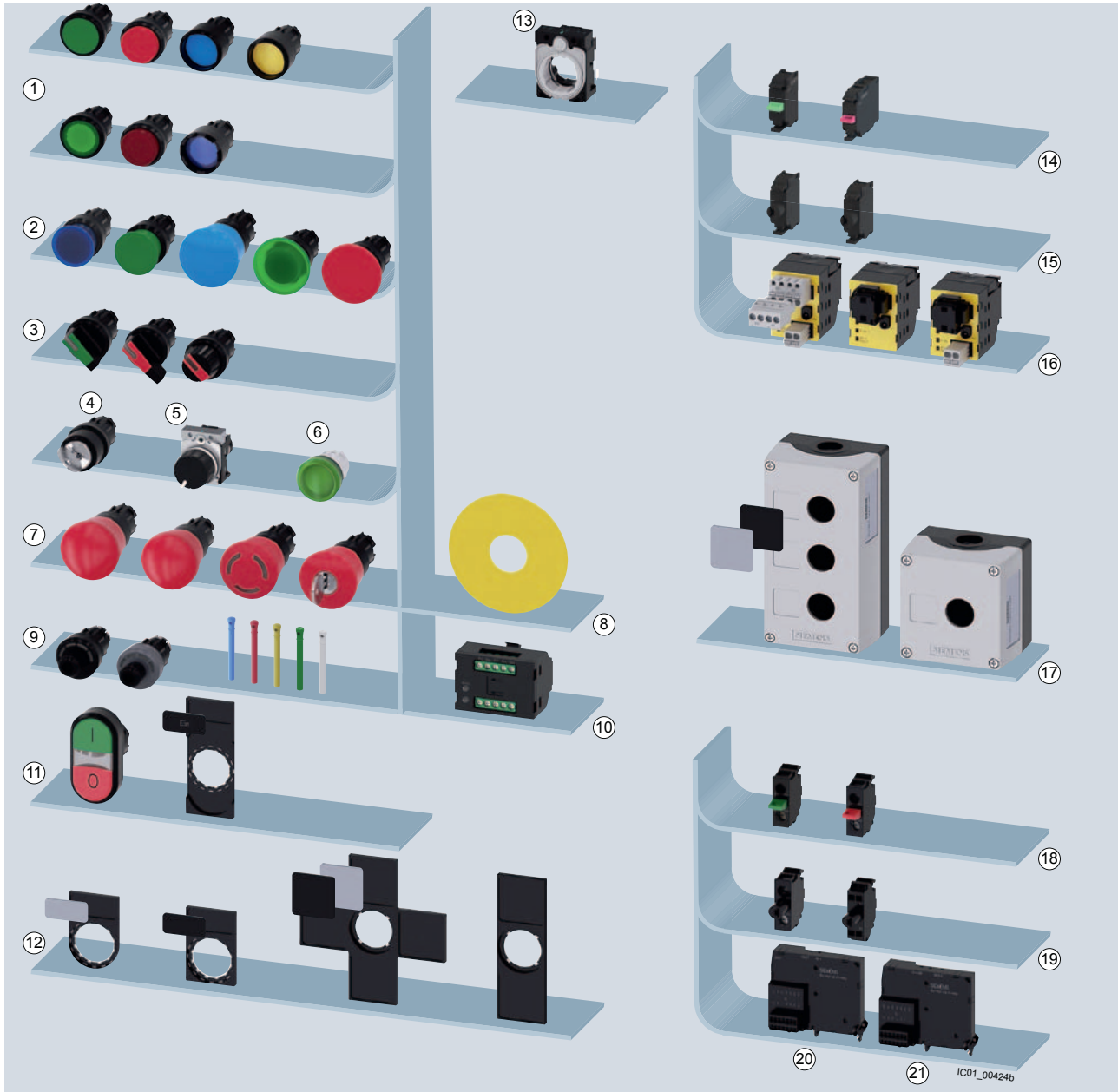

Actuating and signaling elements		Pages	Modules for front plate mounting		Pages
①	Pushbuttons, illuminated pushbuttons	10/38	⑭	Contact modules	10/107
②	Mushroom pushbuttons	10/40	⑮	LED modules	10/111
③	Selector switches	10/41	⑯	AS-Interface modules	10/113
④⑤⑥	Key-operated switches, potentiometers, indicator lights	10/42	Enclosures		Pages
⑦⑧	EMERGENCY STOP mushroom pushbuttons, backing plates	10/40	⑰	Enclosures	10/117
⑨⑩	ID key-operated switches, ID keys, electronic modules	10/57	Modules for base mounting		Pages
⑪	Twin pushbuttons, label holders, labeling plates	10/49	⑱	Contact modules	10/125
⑫	Label holders, labeling plates	10/130	⑲	LED modules	10/125
Holders and labels		Pages	⑳	IO-Link modules	10/128
⑬	Holders	10/130	㉑	AS-Interface modules	10/128

System overview of SIRIUS ACT pushbuttons and indicator lights from the plastic design line. Pushbuttons and indicator lights available in 4 design lines.

SIRIUS ACT 3SU Series

General data

SIRIUS ACT with PROFINET

SIRIUS ACT with PROFINET connects pushbuttons and indicator lights directly via PROFINET to the controller and HMI devices – including with safety functions.

With this solution designed for the control panel, up to 21 SIRIUS ACT devices can be connected to the controller via PROFINET. Integration of the EMERGENCY STOP mushroom pushbutton (SIL 3, PLe) is possible via PROFIsafe. Non SIRIUS ACT devices, e.g. position switches, can additionally be connected via the open, digital/analog interfaces (DI, DQ, AI).

The system is entirely integrated into TIA Portal and does not require any further addressing apart from the IP address for PROFINET.

Quick and easy installation with flat cables without special tools saves significantly on wiring outlay.

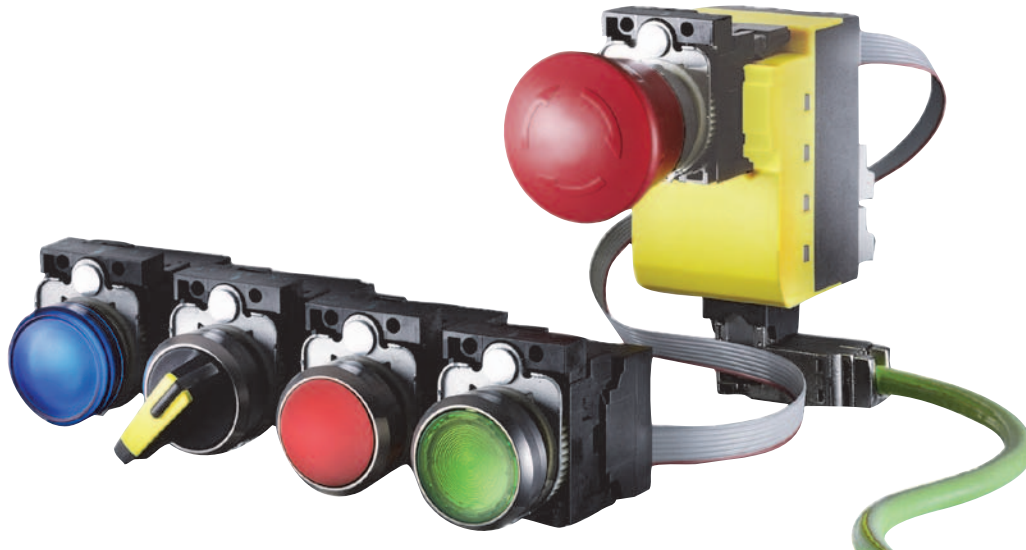

Interface modules/fail-safe interface modules			
	<p>Interface module for PROFINET, 24 V DC 1 ... 20 terminal modules can be connected</p>	<p>3SU1400-1L□10-□AA1</p>	<p>See page 10/116</p>
Terminal modules			
	<p>Terminal modules with 2 contacts Terminal modules with 2 contacts and integrated LED Terminal modules with integrated LED</p>	<p>3SU1401-1MA□0-1□A1 3SU1401-1MC□0-1□A1 3SU1401-1ME□0-1□A1</p>	<p>See page 10/116</p>
Accessories			
	<p>Memory module For backing up the complete parameterization of the 3SK2 safety system without a PC/PG through the system interface</p> <p>LED modules for mounting on printed-circuit boards</p> <p>Flat ribbon cable 7 cores, length 10 m 7 cores, length 5 m</p>	<p>3RK3931-0AA00</p> <p>3SU1401-3BA□0-5AA0</p> <p>3SU1900-0KQ80-0AA0 3SU1900-0KP80-0AA0</p>	<p>See page 10/116</p> <p>See page 10/112</p> <p>See page 10/156</p>

SIRUS ACT 3SU Series

General data

ID key-operated switches

The ID key-operated switch is electronic and has 4 switch positions that are selected by keys with different codes. Using the 4 ID keys with different codes, it is possible to select 1 of 4 positions. The ID keys are color-coded (yellow, blue, red, green, white) so that they can be clearly differentiated at a glance.

Different versions of ID key-operated switches are available depending on the following features:

- Front ring material
- Conventional variant: 1 + 4 non-isolated outputs
- Variant with IO-Link: Option of individual coding

Operation: Insert ID key, turn key to select the position. Standard keys can also be used in conjunction with the electronic module for ID key-operated switches with IO-Link function. The white ID key is supplied without coding.



3SU1000-4WS10-0AA0
Plastic, black



3SU1030-4WS10-0AA0
Plastic with metal front ring, matte

ID key-operated switches		
Number of switching positions	4	4
Operating angle	45°	45°
Operating principle	Latching	Latching
Switch position for key removal	Key removal possible in all 4 positions	Key removal possible in all 4 positions
Color	Black	Black
Pages	10/57	10/77



3SU1400-1GC10-1AA0



3SU1400-1GD10-1AA0

Electronic modules for ID key-operated switches		
Type of power supply	--	via IO-Link master
Protocol is supported	--	IO-Link protocol
Number of NO contacts	5	5
IO-Link transfer rate	--	COM2 (38.4 Kbaud)
Pages	10/115	10/115



3SU1900-0FU60-0AA0

ID keys ID group individual



3SU1900-0FV40-0AA0
3SU1900-0FW30-0AA0
3SU1900-0FX20-0AA0
3SU1900-0FY50-0AA0

ID keys

ID keys		
Material	Plastic	Plastic
Version of RFID coding	Individually coded, programmable several times	ID group 1 ID group 2 ID group 3 ID group 4 Green Yellow Red Blue
Color	White	
Pages	10/152	10/152

SIRUS ACT 3SU Series

General data

Article No. scheme

Device types

3SU10	3SU11	3SU12	3SU14	3SU15	3SU18	3SU19
Device types						
Actuating and signaling elements	Complete units	Compact units	Modules for actuators and indicators	Holders with module	Enclosures	Accessories

Actuating and signaling elements

Product versions		Article number														
SIRIUS ACT pushbuttons and indicator lights		3SU1	<input type="checkbox"/>	<input type="checkbox"/>	<input type="checkbox"/>	-	<input type="checkbox"/>	<input type="checkbox"/>	<input type="checkbox"/>	<input type="checkbox"/>	<input type="checkbox"/>	<input type="checkbox"/>	-	<input type="checkbox"/>	<input type="checkbox"/>	<input type="checkbox"/>
Device type	Actuating and signaling elements	0														
Material (front ring)	Plastic, black	0														
	Metal, matte (front ring)/ plastic, black (rosette)	3														
	Metal, shiny	5														
	Metal, matte	6														
Illumination	Non-illuminated	0														
	Illuminated/transparent	1														
	Illuminated/non illuminated	2														
Type of actuator/indicator	Pushbutton	0														
	Mushroom pushbutton/ EMERGENCY STOP mushroom	1														
	pushbutton/sensor switch	2														
	Selector switch	3														
	Twin pushbutton, toggle switch	4/5														
	Key-operated switch	6														
	Indicator light/acoustic signaling device Coordinate switch	7														
Design of the actuator/ acoustic signaling device	e.g. A = Flat								<input type="checkbox"/>							
Function	e.g. B = Momentary contact									<input type="checkbox"/>						
Color/key removal position	e.g. 10 = Black, 20 = Red										<input type="checkbox"/>	<input type="checkbox"/>				
Connection type	0 = None													<input type="checkbox"/>		
Module/holder equipment	e.g. A = without module, without holder Y = without module, with holder														<input type="checkbox"/>	
Marking	e.g. A = None, C = "I", D = "O", R = "R"															<input type="checkbox"/>
Ambient condition	Standard, ATEX															0 1
Example		3SU1	0	0	0	-	0	A	B	1	0	-	0	A	A	0

Note:

The Article No. scheme shows an overview of product versions for better understanding of the logic behind the article numbers.

For your orders please use the article numbers quoted in the selection and ordering data.

SIRIUS ACT 3SU Series

General data

Complete units

Product versions		Article number														
SIRIUS ACT pushbuttons and indicator lights		3SU1	<input type="checkbox"/>	<input type="checkbox"/>	<input type="checkbox"/>	-	<input type="checkbox"/>	<input type="checkbox"/>	<input type="checkbox"/>	<input type="checkbox"/>	<input type="checkbox"/>	-	<input type="checkbox"/>	<input type="checkbox"/>	<input type="checkbox"/>	
Device type	Complete units	1														
Material (front ring)	Plastic, black	0														
	Metal, matte (front ring)/ plastic, black (rosette)	3														
	Metal, shiny	5														
	Metal, matte	6														
Illumination	Non-illuminated	0														
	Illuminated (with/without LED, various voltages)	1...8														
Type of actuator/indicator	Pushbutton	0														
	Mushroom pushbutton/EMERGENCY	1														
	STOP mushroom pushbutton/ sensor switch	2														
	Selector switch	3														
	Twin pushbutton, toggle switch	4/5														
	Key-operated switch	6														
	Indicator light/acoustic signaling device Coordinate switch	7														
Design of the actuator/acoustic signaling device	e.g. A = Flat						<input type="checkbox"/>									
Function	e.g. B = Momentary contact							<input type="checkbox"/>								
Color/key removal position	e. g. 10 = Black, 20 = Red								<input type="checkbox"/>	<input type="checkbox"/>						
Connection type	Screw terminals	1														
	Spring-type terminals	3														
Module/holder equipment incl. contact material	e. g.												<input type="checkbox"/>			
	A = Without module, with holder															
	B = 1 NO contact with holder C = 1 NC contact with holder															
Marking	e.g. A = None, C = "I", D = "O", R = "R"													<input type="checkbox"/>		
Ambient condition	Standard	0														
	ATEX	1														
Example		3SU1	1	0	0	-	0	A	A	1	0	-	1	B	A	0

Compact units

Product versions		Article number														
SIRIUS ACT pushbuttons and indicator lights		3SU1	<input type="checkbox"/>	<input type="checkbox"/>	<input type="checkbox"/>	-	<input type="checkbox"/>	<input type="checkbox"/>	<input type="checkbox"/>	<input type="checkbox"/>	<input type="checkbox"/>	-	<input type="checkbox"/>	<input type="checkbox"/>	<input type="checkbox"/>	
Device type	Compact units	2														
Material (front ring)	Plastic, black	0														
	Metal, matte (front ring)/ plastic, black (rosette)	3														
	Metal, shiny	5														
	Metal, matte	6														
Illumination	Non-illuminated	0														
	Illuminated/non illuminated	1														
Type of actuator/indicator	Pushbutton	0														
	Sensor switch	1														
	Potentiometer	2														
	Indicator light/acoustic signaling device	6														
Design of the actuator/acoustic signaling device	e.g. A = Flat						<input type="checkbox"/>									
Function (voltage/resistance)	e.g. B = 24 V AC/DC							<input type="checkbox"/>								
Color	e. g. 10 = Black, 20 = Red								<input type="checkbox"/>	<input type="checkbox"/>						
Connection type	None	0														
	Screw terminals	1														
	M12 connection, 4-pole	2														
	Spring-type terminals	3														
Module/holder equipment incl. contact material	e. g.												<input type="checkbox"/>			
	A = Without module, without holder															
	B = 1 NO contact with holder C = 1 NC contact with holder															
Marking	e.g. A = none													<input type="checkbox"/>		
Ambient condition	Standard	0														
	ATEX	1														
Example		3SU1	2	0	1	-	6	A	B	0	0	-	1	A	A	0

Note:

The Article No. scheme shows an overview of product versions for better understanding of the logic behind the article numbers.

For your orders please use the article numbers quoted in the selection and ordering data.

SIRIUS ACT 3SU Series

General data

Modules for actuators and indicators

Product versions		Article number														
SIRIUS ACT pushbuttons and indicator lights		3SU1	<input type="checkbox"/>	<input type="checkbox"/>	<input type="checkbox"/>	-	<input type="checkbox"/>	<input type="checkbox"/>	<input type="checkbox"/>	<input type="checkbox"/>	<input type="checkbox"/>	-	<input type="checkbox"/>	<input type="checkbox"/>	<input type="checkbox"/>	
Device type	Modules for actuators and indicators	4														
Material (front ring)	Plastic, black	0														
Illumination	Non-illuminated	0														
	Illuminated	1														
Type of mounting	Front plate mounting					1										
	Base mounting					2										
	Printed circuit board					3										
Module type	Contact module									A						
	LED module									B						
	LED test module									C						
	Support terminal									D						
	AS-Interface module									E						
	Electronic module for ID key-operated switches									G						
Function/voltage	e.g. B = 24 V AC/DC								<input type="checkbox"/>							
Color	e. g. 10 = Black, 20 = Red								<input type="checkbox"/>	<input type="checkbox"/>						
Connection type	Screw terminals													1		
	Screw terminals + insulation piercing method													2		
	Spring-type terminals													3		
	Spring-type terminals + insulation piercing method													4		
	Socket terminals													5		
Module equipment incl. contact material	e. g. A = None B = 1 NO contact, silver C = 1 NC contact, silver												<input type="checkbox"/>			
Marking	None														A	
Ambient condition	Standard ATEX															0 1
Example		3SU1	4	0	0	-	1	A	A	1	0	-	1	B	A	0

Holders

Product versions		Article number														
SIRIUS ACT pushbuttons and indicator lights		3SU1	<input type="checkbox"/>	<input type="checkbox"/>	<input type="checkbox"/>	-	<input type="checkbox"/>	<input type="checkbox"/>	<input type="checkbox"/>	<input type="checkbox"/>	<input type="checkbox"/>	-	<input type="checkbox"/>	<input type="checkbox"/>	<input type="checkbox"/>	
Device type	Holder	5														
Material (front ring)	Plastic, black	0														
	Metal, shiny	5														
Illumination	Non-illuminated	0														
	Illuminated	1														
Type of mounting	None					0										
	Front plate mounting					1										
Holder type	3x A									A						
	4x B									B						
Function/voltage	None 6 ... 24 V AC/DC									A						
Color	e.g. 10 = Black, 20 = Red									<input type="checkbox"/>	<input type="checkbox"/>					
Connection type	None													0		
	Screw terminals													1		
Module equipment incl. contact material and slot	e. g. A = None B = 1 NO contact, silver C = 1 NC contact, silver												<input type="checkbox"/>			
Marking	None														A	
Ambient condition	Standard ATEX															0 1
Example		3SU1	5	0	0	-	0	A	A	1	0	-	0	A	A	0

Note:

The Article No. scheme shows an overview of product versions for better understanding of the logic behind the article numbers.

For your orders please use the article numbers quoted in the selection and ordering data.

SIRIUS ACT 3SU Series

General Data

Enclosures

Product versions		Article number														
SIRIUS ACT pushbuttons and indicator lights		3SU1	<input type="checkbox"/>	<input type="checkbox"/>	<input type="checkbox"/>	-	<input type="checkbox"/>	<input type="checkbox"/>	<input type="checkbox"/>	<input type="checkbox"/>	-	<input type="checkbox"/>	<input type="checkbox"/>	<input type="checkbox"/>	<input type="checkbox"/>	
Device type	8 = Enclosure	8														
Material (enclosure/front ring)	Plastic / black plastic Metal, shiny metal	0 5														
Number of command points	1 command point ... 6 command points	1 ... 6														
Type of enclosure	Configuration 4-position selector switches and coordinate switches Palm pushbutton Two-hand operation console	0 1 2 3														
Equipment	e.g. command point, inscription, module						<input type="checkbox"/>	<input type="checkbox"/>								
Communication capability	None AS-i									0 1						
Ambient condition	Standard ATEX										0 1					
Mounting/ connection of modules	None Front plate mounting, screw terminals Base mounting, screw terminals Base mounting, spring-type terminals												0 1 2 3			
Cable exit from enclosure	None Direct entry of AS-i flat cable at top/on right AS-i insulation piercing method at top/ on right													A G H		
Design of enclosure top	Center command point With recess for labeling plate With protective collar 4 additional holes (two-hand operation console) 8 additional premachined breaking points (two-hand operation console)													A B C D E		
Color of enclosure top	Gray Yellow														8	
Example		3SU1	8	0	1	-	0	A	A	0	0	-	0	A	A	2

Accessories

Product versions		Article number														
SIRIUS ACT Pushbuttons and Indicator Lights		3SU1	<input type="checkbox"/>	<input type="checkbox"/>	<input type="checkbox"/>	-	<input type="checkbox"/>	<input type="checkbox"/>	<input type="checkbox"/>	<input type="checkbox"/>	-	<input type="checkbox"/>	<input type="checkbox"/>	<input type="checkbox"/>	<input type="checkbox"/>	
Device type	Accessories	9														
Material	Plastic, black Metal/plastic Metal, shiny Metal, matte	0 3 5 6														
Illumination	Non-illuminated Illuminated	0 1														
Type of accessory (labels, protection, actuator, enclosure)	e. g. 0AB = Insert label						<input type="checkbox"/>	<input type="checkbox"/>	<input type="checkbox"/>							
Color	e. g. 10 = Black, 20 = Red									<input type="checkbox"/>	<input type="checkbox"/>					
Marking	e. g. 0AA = None 0AB = ON 0AT = EMERGENCY STOP												<input type="checkbox"/>	<input type="checkbox"/>	<input type="checkbox"/>	
Ambient condition	Standard ATEX														0 1	
Example		3SU1	9	0	0	0	0	A	B	7	1	0	0	A	B	0

Note:

The Article No. scheme shows an overview of product versions for better understanding of the logic behind the article numbers. For your orders please use the article numbers quoted in the selection and ordering data.

Benefits

Advantages through energy efficiency

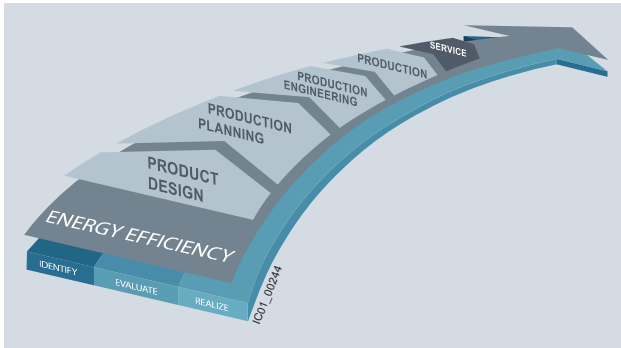

Energy management in industry

Overview of the energy management process

We offer you a unique portfolio for efficient energy management in the industry – a process that is used to optimize the energy requirements. We divide operational energy management into the three phases: identification, evaluation and implementation, and support you with suitable hardware and software solutions in each phase of the process.

The innovative products of the SIRIUS industrial controls portfolio can also make a substantial contribution to a plant's energy efficiency (see www.siemens.com/sirius/energysaving).

SIRIUS ACT pushbuttons and indicator lights contribute to energy efficiency throughout the plant as follows:

- Lower power consumption by means of LED technology
- Long service life

Application

Environmental conditions

The pushbuttons and indicator lights are climate-proof (KTW 24) and suitable for standard industrial applications and operation in marine applications.

Safety EMERGENCY STOP pushbuttons according to ISO 13850

For controls according to IEC 60204-1 or EN 60204-1, the SIRIUS ACT mushroom pushbuttons are suitable for use as safety EMERGENCY STOP pushbuttons.

Safety circuits

IEC 60947-5-1 and EN 60947-5-1 require positive opening. This means that for the purpose of personal safety, the reliable opening of NC contacts in all safety circuits is expressly prescribed for the electrical equipment of machines and is designated according to IEC 60947-5-1 with the symbol (⊖).

Category 4 according to EN ISO 13849-1 can be attained with the EMERGENCY STOP mushroom pushbuttons if the corresponding fail-safe evaluation units are selected and correctly installed, e.g. the 3SK11 safety relays or the 3RK3 Modular Safety System (see page 11/1 onwards) or matching units from the ASIsafe, SIMATIC or SINUMERIK product ranges.

The SIRIUS ACT pushbuttons and indicator lights can be connected to the AS-Interface communication system quickly and safely.

The following solutions are available:

- AS-Interface modules
- AS-Interface module in safety-related version for EMERGENCY STOP mushroom pushbutton
- Ready-fitted AS-Interface enclosures with 1 to 6 command points

IO-Link

The SIRIUS ACT pushbuttons and indicator lights can be connected to IO-Link quickly and safely. The connection is made via a special IO-Link-module.

Technical specifications

Type	3SU1..0-AA 3SU1..0-JA		3SU1..1-AA 3SU1..1-JA		3SU1..0-AB 3SU1..0-BB 3SU1..0-CB 3SU1..0-DB 3SU1..0-JB		3SU1..1-AB 3SU1..1-BB 3SU1..1-JB			
Product version	Pushbuttons									
Operating principle of the actuating element	Latching				Momentary contact					
Optional expansion of product by light source	No		Yes		No		Yes			
Mechanical endurance (operating cycles) typical	500 000				10 000 000		3 000 000			
Switching frequency maximum	1/h	1 800			3 600					
Shock resistance acc. to IEC 60068-2-27	Half-sine wave 50 g / 11 ms									
Vibration resistance acc. to IEC 60068-2-6	10 ... 500 Hz: 5 g									
IP degree of protection	IP66, IP67, IP69 (IP69K)									
Environmental category during operation according to IEC 60721	3M6, 3S2, 3B2, 3C3, 3K6 (with a relative air humidity of 10 ... 95%)									
Ambient temperature										
• During operation	°C	-25 ... +70								
• During storage	°C	-40 ... +80								
Type	3SU1.00-AA 3SU1.00-BA 3SU1.00-CA 3SU1.30-AA 3SU1.30-BA 3SU1.50-AA 3SU1.50-BA 3SU1.50-CA		3SU1.50-EA		3SU1.01-AA 3SU1.01-BA 3SU1.51-AA 3SU1.51-BA 3SU1.51-CA		3SU1.00-AD 3SU1.00-BD 3SU1.00-CD 3SU1.30-AD 3SU1.30-BD 3SU1.50-AD 3SU1.50-BD 3SU1.50-CD		3SU1.50-ED 3SU1.01-AD 3SU1.01-BD 3SU1.31-AD 3SU1.31-BD	
Product version	Mushroom pushbuttons									
Operating principle of the actuating element	Latching					Momentary contact				
Optional expansion of product by light source	No			Yes		No			Yes	
Mechanical endurance (operating cycles) typical	500 000		300 000		500 000		10 000 000		3 000 000	
Switching frequency maximum	1/h	1 800			3 600			1 800		3 600
Shock resistance acc. to IEC 60068-2-27	Half-sine wave 50 g / 11 ms									
Vibration resistance acc. to IEC 60068-2-6	10 ... 500 Hz: 5 g									
IP degree of protection	IP66, IP67, IP69 (IP69K)		IP65, IP67, IP69 (IP69K)		IP66, IP67, IP69 (IP69K)			IP65, IP67, IP69 (IP69K)		IP66, IP67, IP69 (IP69K)
Environmental category during operation according to IEC 60721	3M6, 3S2, 3B2, 3C3, 3K6 (with a relative air humidity of 10 ... 95%)									
Ambient temperature										
• During operation	°C	-25 ... +70								
• During storage	°C	-40 ... +80								
Type	3SU1...-J 3SU1...-H 3SU1...-G									
Product version	EMERGENCY STOP mushroom pushbuttons									
Mechanical endurance (operating cycles)	300 000									
Switching frequency maximum	1/h	600								
Shock resistance acc. to IEC 60068-2-27	Half-sine wave 50 g / 11 ms									
Vibration resistance acc. to IEC 60068-2-6	10 ... 500 Hz: 5 g									
IP degree of protection	IP66, IP67, IP69 (IP69K)									
Environmental category during operation according to EN 60721	3M6, 3S2, 3B2, 3C3, 3K6 (with a relative air humidity of 10 ... 95%)									
Ambient temperature										
• During operation	°C	-25 ... 70								
• During storage	°C	-40 ... 80								

¹⁾ UL NEMA rating for twin pushbuttons (all types) – NEMA Type: 1, 2, 3, 3R, 4, 4X



SIRUS ACT 3SU Series



General data

Type	3SU1.5.-2A 3SU1.5.-2B 3SU1.5.-2C 3SU1.5.-2D 3SU1.5.-2E	3SU1.0.-2A 3SU1.0.-2B 3SU1.0.-2C 3SU1.3.-2A 3SU1.3.-2B 3SU1.3.-2C	3SU1.0.-3E 3SU1.3.-3E 3SU1.5.-3E	3SU1.0.-4B 3SU1.0.-4C 3SU1.0.-4D 3SU1.0.-4F 3SU1.0.-4G 3SU1.0.-4H 3SU1.0.-4J 3SU1.0.-4L 3SU1.0.-5B 3SU1.0.-5H 3SU1.0.-5P 3SU1.0.-5Q 3SU1.0.-5R 3SU1.0.-5S 3SU1.0.-5T 3SU1.0.-5X	3SU1...-4B 3SU1...-4C 3SU1...-4D 3SU1...-4F 3SU1...-4G 3SU1...-4H 3SU1...-4J 3SU1...-4L 3SU1...-5B 3SU1...-5H 3SU1...-5K 3SU1...-5L 3SU1...-5P 3SU1...-5Q 3SU1...-5R 3SU1...-5S 3SU1...-5T 3SU1...-5X	3SU1.0.-7A 3SU1.0.-7B 3SU1.3.-7A 3SU1.3.-7B 3SU1.5.-7A 3SU1.5.-7B	
Product version	Selector switches		Toggle switches	Key-operated switches		Coordinate switches	
Mechanical endurance (operating cycles)	300 000	1 000 000			300 000	250 000	
Switching frequency maximum	1/h	1 800				3 600	
Shock resistance acc. to IEC 60068-2-27	Half-sine wave 50 g / 11 ms						
Vibration resistance acc. to IEC 60068-2-6	10 ... 500 Hz: 5 g						
IP degree of protection	IP66, IP67, IP69 (IP69K)		IP66, IP67, IP69K	IP66, IP67, IP69 (IP69K)		IP65, IP67	
Ambient temperature							
• During operation	°C	-25 ... +70					
• During storage	°C	-40 ... +80					
Type	3SU1400- .AA101-.A0	3SU1400- 1AA101-GA0, 3SU1400- 1AA101-RA0	3SU1400- 1AA101-HA0	3SU1400- .AA103-.A0	3SU1400- 1AA103-GA0, 3SU1400- 1AA103-RA0	3SU1400- 1AA103-HA0	3SU1400- 3AA105-.A0
Product version	Contact modules						
Rated insulation voltage	V	500					
Pollution degree		3					
Impulse withstand voltage	kV	6					
Rated value							
Operational voltage type		AC/DC					
Operational voltage, rated value							
• At AC at 50 Hz	V	5 ... 500					
• At DC	V	5 ... 500					
Thermal current	A	10					
Operational current, rated value							
• At AC-12							
- At 24 V	A	10					
- At 230 V	A	8					
• At AC-15							
- At 24 V	A	6					
- At 230 V	A	4		6		4	
- At 400 V	A	3					
- At 500 V	A	1.4					
• At DC-12							
- At 24 V	A	10					
- At 48 V	A	5					
- At 110 V	A	2.5					
- At 230 V	A	1		0.3		1	
- At 400 V	A	0.3					
- At 500 V	A	0.3		0.2		0.3	
• At DC-13							
- At 24 V	A	3					
- At 48 V	A	1.5					
- At 110 V	A	0.7		0.6		0.7	
- At 230 V	A	0.3					
- At 400 V	A	0.1					
- At 500 V	A	0.1					
Contact reliability		One contact failure per 100 million (17 V, 5 mA), one contact failure per 10 million (5 V, 1 mA)					
Mechanical endurance (operating cycles) typical		10 000 000					

SIRUS ACT 3SU Series

General data

Type	3SU1400- .AA101-.A0	3SU1400- 1AA101-GA0, 3SU1400- 1AA101-RA0	3SU1400- 1AA101-HA0	3SU1400- .AA103-.A0	3SU1400- 1AA103-GA0, 3SU1400- 1AA103-RA0	3SU1400- 1AA103-HA0	3SU1400- 3AA105-.A0
Product version	Contact modules						
Switching frequency maximum	1/s	3600					
Fuse link version required for short-circuit protection of the auxiliary switch with type of coordination 1		gG / Dz 10 A, quick-response / Dz 10 A					
Continuous current of miniature circuit breaker C characteristic	A	10					
Vibration resistance acc. to IEC 60068-2-6		10 ... 500 Hz: 5 g					
Shock resistance acc. to IEC 60068-2-27		Half-sine wave 50 g / 11 ms					
Climate class during operation according to EN 60721		3M6, 3S2, 3B2, 3C3, 3K6 (with a relative air humidity of 10 ... 95%, no condensation permitted in operation)					
Ambient temperature		<ul style="list-style-type: none"> • During operation °C -25 ... +70 • During storage °C -40 ... +80 					
IP degree of protection		<ul style="list-style-type: none"> • of the enclosure IP40 • of the terminal IP20 					
Type of electrical connection		Screw terminals 		Spring-type terminals 		Socket terminals (THT) 	
Type of connectable conductor cross-sections		<ul style="list-style-type: none"> • Solid with end sleeve 2 x (0.5 ... 0.75 mm²) • Solid without end sleeve 2 x (1.0 ... 1.5 mm²) • Finely stranded with end sleeve 2 x (0.5 ... 1.5 mm²) • Finely stranded without end sleeve 2 x (1.0 ... 1.5 mm²) • For AWG cables 2 x (18 ... 14) 		<ul style="list-style-type: none"> -- 2 x (0.25 ... 1.5 mm²) 2 x (0.25 ... 0.75 mm²) 2 x (0.25 ... 1.5 mm²) 2 x (24 ... 16) 		<ul style="list-style-type: none"> -- -- -- -- 	
Tightening torque for screw terminals	Nm	0.8 ... 0.9		--			

Type	3SU1401-.....-1	3SU1401-.....-3	3SU1401-.....-5
Product version	LED module		
Light source integrated in product	Yes		
Type of light source	LED		
Rated insulation voltage	V	320	
Pollution degree		3	
Rated impulse withstand voltage	kV	4	
Relative positive tolerance of the operational voltage	%	20	
Relative negative tolerance of the operational voltage	%	20	
Operating time typical	h	100 000	
Vibration resistance acc. to IEC 60068-2-6		10 ... 500 Hz: 5 g	
Shock resistance acc. to IEC 60068-2-27		Half-sine wave 50 g / 11 ms	
Environmental category during operation according to IEC 60721		3M6, 3S2, 3B2, 3K6 (with a relative air humidity of 10 ... 95%, no condensation permitted in operation)	
Ambient temperature		<ul style="list-style-type: none"> • During operation °C -25 ... +70 • During storage °C -40 ... +80 	
IP degree of protection of the terminal		IP20	
Type of electrical connection		Screw terminals 	Spring-type terminals 
			Socket terminals (THT) 

For further information in the Manual, see <https://support.industry.siemens.com/cs/ww/en/view/107542462>.

3SU1 22 mm, Round, Plastic, Black — Complete Units

Pushbuttons

Selection and ordering data

Supply voltage for light source at		Color	Number of			SD	Screw terminals	PU (UNIT, SET, M)	PS*
AC	DC		Contact modules	NO contacts	NC contacts				
V	V					Article No.	Price per PU		

Pushbuttons

Pushbuttons with flat button, momentary contact



3SU1100-0AB40-1BA0

--	--	Black	1	1	0	▶	3SU1100-0AB10-1BA0	1	1 unit
			0	0	1	▶	3SU1100-0AB10-1CA0	1	1 unit
			1	1	1	▶	3SU1100-0AB10-1FA0	1	1 unit
		Red	1	1	0	▶	3SU1100-0AB20-1BA0	1	1 unit
			0	0	1	▶	3SU1100-0AB20-1CA0	1	1 unit
				1	1	▶	3SU1100-0AB20-1FA0	1	1 unit
		Yellow	1	1	0	3	3SU1100-0AB30-1BA0	1	1 unit
				1	1	3	3SU1100-0AB30-1FA0	1	1 unit
		Green	1	1	0	▶	3SU1100-0AB40-1BA0	1	1 unit
				1	1	▶	3SU1100-0AB40-1FA0	1	1 unit
		Blue	1	1	0	▶	3SU1100-0AB50-1BA0	1	1 unit
				1	1	3	3SU1100-0AB50-1FA0	1	1 unit
		White	1	1	0	▶	3SU1100-0AB60-1BA0	1	1 unit
				1	1	3	3SU1100-0AB60-1FA0	1	1 unit
		Clear	1	1	0	5	3SU1100-0AB70-1BA0	1	1 unit
				1	1	5	3SU1100-0AB70-1FA0	1	1 unit
		Gray	1	1	1	5	3SU1100-0AB80-1FA0	1	1 unit

Pushbuttons with raised button, momentary contact



3SU1100-0BB20-1CA0

--	--	Black	1	0	1	5	3SU1100-0BB10-1CA0	1	1 unit
				1	1	5	3SU1100-0BB10-1FA0	1	1 unit
		Red	1	0	1	5	3SU1100-0BB20-1CA0	1	1 unit
				1	1	5	3SU1100-0BB20-1FA0	1	1 unit
		Blue	1	1	0	5	3SU1100-0BB50-1BA0	1	1 unit

Illuminated pushbuttons with flat button, momentary contact with integrated LED



3SU1102-0AB40-1BA0

24	24	Red	1	1	0	5	3SU1102-0AB20-1BA0	1	1 unit
				0	1	▶	3SU1102-0AB20-1CA0	1	1 unit
				1	1	▶	3SU1102-0AB20-1FA0	1	1 unit
		Yellow	1	1	0	▶	3SU1102-0AB30-1BA0	1	1 unit
				1	1	3	3SU1102-0AB30-1FA0	1	1 unit
		Green	1	1	0	▶	3SU1102-0AB40-1BA0	1	1 unit
				1	1	▶	3SU1102-0AB40-1FA0	1	1 unit
		Blue	1	1	0	▶	3SU1102-0AB50-1BA0	1	1 unit
				1	1	3	3SU1102-0AB50-1FA0	1	1 unit
		White	1	1	0	▶	3SU1102-0AB60-1BA0	1	1 unit
				1	1	▶	3SU1102-0AB60-1FA0	1	1 unit
		Clear	1	1	0	▶	3SU1102-0AB70-1BA0	1	1 unit
				1	1	3	3SU1102-0AB70-1FA0	1	1 unit



3SU1103-0AB20-1CA0

110	--	Red	1	0	1	5	3SU1103-0AB20-1CA0	1	1 unit
				1	1	3	3SU1103-0AB20-1FA0	1	1 unit
		Yellow	1	1	0	5	3SU1103-0AB30-1BA0	1	1 unit
				1	1	5	3SU1103-0AB30-1FA0	1	1 unit
		Green	1	1	0	3	3SU1103-0AB40-1BA0	1	1 unit
				1	1	3	3SU1103-0AB40-1FA0	1	1 unit
		Blue	1	1	0	5	3SU1103-0AB50-1BA0	1	1 unit
				1	1	5	3SU1103-0AB50-1FA0	1	1 unit
		White	1	1	0	5	3SU1103-0AB60-1BA0	1	1 unit
				1	1	5	3SU1103-0AB60-1FA0	1	1 unit
		Clear	1	1	0	5	3SU1103-0AB70-1BA0	1	1 unit
				1	1	5	3SU1103-0AB70-1FA0	1	1 unit

3SU1 22 mm, Round, Plastic, Black — Complete Units

Pushbuttons

Supply voltage for light source		Color	Number of			SD	Screw terminals	PU (UNIT, SET, M)	PS*
At AC	At DC		Contact modules	NO contacts	NC contacts				
V	V					d	Article No.	Price per PU	

Pushbuttons

Illuminated pushbuttons with flat button, momentary contact With integrated LED



3SU1106-0AB40-1BA0

230	--	Red	1	0	1	5	3SU1106-0AB20-1CA0	1	1 unit
				1	1	3	3SU1106-0AB20-1FA0	1	1 unit
		Yellow	1	1	0	5	3SU1106-0AB30-1BA0	1	1 unit
				1	1	5	3SU1106-0AB30-1FA0	1	1 unit
		Green	1	1	0	3	3SU1106-0AB40-1BA0	1	1 unit
				1	1	3	3SU1106-0AB40-1FA0	1	1 unit
		Blue	1	1	0	5	3SU1106-0AB50-1BA0	1	1 unit
				1	1	5	3SU1106-0AB50-1FA0	1	1 unit
		White	1	1	0	5	3SU1106-0AB60-1BA0	1	1 unit
				1	1	5	3SU1106-0AB60-1FA0	1	1 unit
		Clear	1	1	0	5	3SU1106-0AB70-1BA0	1	1 unit
				1	1	5	3SU1106-0AB70-1FA0	1	1 unit

Spring-type terminals

Pushbuttons with flat button, momentary contact



3SU1100-0AB30-3BA0

--	--	Black	1	1	0	3	3SU1100-0AB10-3BA0	1	1 unit
				0	1	5	3SU1100-0AB10-3CA0	1	1 unit
				1	1	5	3SU1100-0AB10-3FA0	1	1 unit
		Red	1	0	1	5	3SU1100-0AB20-3CA0	1	1 unit
				1	1	5	3SU1100-0AB20-3FA0	1	1 unit
		Yellow	1	1	0	5	3SU1100-0AB30-3BA0	1	1 unit
				1	1	5	3SU1100-0AB30-3FA0	1	1 unit
		Green	1	1	0	5	3SU1100-0AB40-3BA0	1	1 unit
				1	1	5	3SU1100-0AB40-3FA0	1	1 unit
		Blue	1	1	0	5	3SU1100-0AB50-3BA0	1	1 unit
				1	1	5	3SU1100-0AB50-3FA0	1	1 unit
		White	1	1	0	5	3SU1100-0AB60-3BA0	1	1 unit
				1	1	5	3SU1100-0AB60-3FA0	1	1 unit

Illuminated pushbuttons with flat button, momentary contact with integrated LED



3SU1102-0AB20-3BA0

24	24	Red	1	0	1	5	3SU1102-0AB20-3CA0	1	1 unit
				1	1	5	3SU1102-0AB20-3FA0	1	1 unit
		Yellow	1	1	0	5	3SU1102-0AB30-3BA0	1	1 unit
				1	1	5	3SU1102-0AB30-3FA0	1	1 unit
		Green	1	1	0	3	3SU1102-0AB40-3BA0	1	1 unit
				1	1	5	3SU1102-0AB40-3FA0	1	1 unit
		Blue	1	1	0	5	3SU1102-0AB50-3BA0	1	1 unit
				1	1	5	3SU1102-0AB50-3FA0	1	1 unit
		White	1	1	0	3	3SU1102-0AB60-3BA0	1	1 unit
				1	1	5	3SU1102-0AB60-3FA0	1	1 unit
		Clear	1	1	0	5	3SU1102-0AB70-3BA0	1	1 unit
				1	1	5	3SU1102-0AB70-3FA0	1	1 unit
110	--	Red	1	0	1	5	3SU1103-0AB20-3CA0	1	1 unit
				1	1	5	3SU1103-0AB20-3FA0	1	1 unit
		Yellow	1	1	1	5	3SU1103-0AB30-3FA0	1	1 unit
		Green	1	1	0	5	3SU1103-0AB40-3BA0	1	1 unit
				1	1	5	3SU1103-0AB40-3FA0	1	1 unit
		Blue	1	1	1	5	3SU1103-0AB50-3FA0	1	1 unit
		White	1	1	0	5	3SU1103-0AB60-3BA0	1	1 unit
				1	1	5	3SU1103-0AB60-3FA0	1	1 unit
		Clear	1	1	0	5	3SU1103-0AB70-3BA0	1	1 unit
				1	1	5	3SU1103-0AB70-3FA0	1	1 unit
230	--	Red	1	0	1	5	3SU1106-0AB20-3CA0	1	1 unit
				1	1	5	3SU1106-0AB20-3FA0	1	1 unit
		Yellow	1	1	1	5	3SU1106-0AB30-3FA0	1	1 unit
		Green	1	1	0	5	3SU1106-0AB40-3BA0	1	1 unit
				1	1	5	3SU1106-0AB40-3FA0	1	1 unit
		Blue	1	1	1	5	3SU1106-0AB50-3FA0	1	1 unit
		White	1	1	0	5	3SU1106-0AB60-3BA0	1	1 unit
				1	1	5	3SU1106-0AB60-3FA0	1	1 unit
		Clear	1	1	0	5	3SU1106-0AB70-3BA0	1	1 unit
				1	1	5	3SU1106-0AB70-3FA0	1	1 unit

3SU1 22 mm, Round, Plastic, Black — Complete Units

Mushroom pushbuttons / EMERGENCY STOP mushroom pushbuttons

Selection and ordering data

Unlatching method	Number of Contact modules	NO contacts	NC contacts	SD	Screw terminals	PU (UNIT, SET, M)	PS*

Mushroom pushbuttons

With red mushroom, diameter 40 mm, latching



3SU1100-1BA20-3CA0

Pull to unlatch	1	0	1	3	Screw terminals	1	1 unit
		1	1	3			
					Article No.		
					Price per PU		
					Spring-type terminals		
Pull to unlatch	1	0	1	5	Spring-type terminals	1	1 unit
		1	1	5			
					Article No.		
					Price per PU		

Selection and ordering data

Unlatching method	Number of Contact modules	NO contacts	NC contacts	Marking	SD	Screw terminals	PU (UNIT, SET, M)	PS*

EMERGENCY STOP mushroom pushbuttons, tamper-proof, in accordance with ISO 13850 and IEC 60947-5-5

With red mushroom, diameter 40 mm, with positive latching



3SU1100-1HA20-1CH0

Pull to unlatch	1	0	1	NOT-HALT	⊖	5	Screw terminals	1	1 unit
		1	1	EMERGENCY STOP	⊖	5			
		1	1	NOT-HALT	⊖	5			
							Article No.		
							Price per PU		



3SU1100-1HB20-1CH0

Rotate to unlatch	1	0	1	None	⊖	5	Screw terminals	1	1 unit
		0	1	EMERGENCY STOP	⊖	5			
		0	1	NOT-HALT	⊖	▶	Screw terminals	1	1 unit
		0	2	EMERGENCY STOP	⊖	5			
		0	2	EMERGENCY STOP	⊖	5	Screw terminals	1	1 unit
				EMERGENCY STOP Less backing plate	⊖	5			
		1	1	EMERGENCY STOP	⊖	5	Screw terminals	1	1 unit
		1	1	NOT-HALT	⊖	▶			
							Article No.		
							Price per PU		



3SU1100-1HB20-3CH0

Rotate to unlatch	1	0	1	NOT-HALT	⊖	5	Spring-type terminals	1	1 unit
		1	1	NOT-HALT	⊖	5			
							Article No.		
							Price per PU		

⊖ Positive opening according to IEC 60947-5-1, Annex K.
Can be used with 3SK11 safety relays or the 3RK3 Modular Safety System;
see Section 13.

Certificate:

3SU1 22 mm, Round, Plastic, Black — Complete Units

Selector switches

Selection and ordering data

Operating principle	Color	Number of			SD	Screw terminals 	PU (UNIT, SET, M)	PS*
		Supply voltage for light source	Contact modules	NO contacts				
						Article No.	Price per PU	

Selector switches

Short black actuator, 2 switch positions, can be illuminated



3SU1100-2BF60-1BA0

Latching, 90° 	White	1	1	0	▶	3SU1100-2BF60-1BA0	1	1 unit
		2	1	1	▶	3SU1100-2BF60-1MA0	1	1 unit
	White 110 V	1	1	0	5	3SU1103-2BF60-1BA0	1	1 unit

Short black actuator, 3 switch positions, can be illuminated

Momentary contact, 2x45°, reset from left + right 	White	2	2	2	3	3SU1100-2BM60-1LA0	1	1 unit
				2	0	▶	3SU1100-2BM60-1NA0	1

Latching, 2x45° 	White	2	2	2	▶	3SU1100-2BL60-1LA0	1	1 unit
				2	0	▶	3SU1100-2BL60-1NA0	1

Short black actuator, 2 switch positions, can be illuminated



3SU1100-2BL60-1NA0

						Spring-type terminals 		
Latching, 90° 	White	1	1	0	5	3SU1100-2BF60-3BA0	1	1 unit
		2	1	1	5	3SU1100-2BF60-3MA0	1	1 unit

Short black actuator, 3 switch positions, can be illuminated

Momentary contact, 2x45°, reset from left + right 	White	2	2	2	5	3SU1100-2BM60-3LA0	1	1 unit
				2	0	5	3SU1100-2BM60-3NA0	1

Latching, 2x45° 	White	2	2	2	5	3SU1100-2BL60-3LA0	1	1 unit
				2	0	5	3SU1100-2BL60-3NA0	1

3SU1 22 mm, Round, Plastic, Black — Complete Units

Key-operated switches

Selection and ordering data

Operating principle	Switch position for key removal	Number of			Number of keys	SD	Screw terminals 	PU (UNIT, SET, M)	PS*
		Contact modules	NO contacts	NC contacts					
							Article No.	Price per PU	

Key-operated switches

With RONIS lock, SB30, 2 switch positions



Latching, 90°
(10:30/1:30 o'clock)



O+I 1 1 0 2 ▶
1 1 1 2 ▶

3SU1100-4BF11-1BA0
3SU1100-4BF11-1FA0

1 1 unit
1 1 unit

With RONIS lock, SB30, 3 switch positions

3SU1100-4BF11-1BA0

Latching, 2x45°
(10:30/1:30 o'clock)



I+O+II 2 2 0 2 5

3SU1100-4BL11-1NA0

1 1 unit

With RONIS lock, SB30, 2 switch positions



Latching, 90°
(10:30/1:30 o'clock)



O+I 1 1 0 2 5
1 1 1 2 5

Spring-type terminals

3SU1100-4BF11-3BA0
3SU1100-4BF11-3FA0

1 1 unit
1 1 unit

With CES lock, SSG10, 2 switch positions

3SU1100-4BL11-1NA0

Latching, 90°
(10:30/1:30 o'clock)



O+I 1 1 1 2 5

3SU1100-5BF11-3FA0

1 1 unit

3SU1 22 mm, Round, Plastic, Black — Complete Units

Coordinate switches

Selection and ordering data

Number of NO contacts (1 per direction)	Operating principle	Direction of actuation	SD	Screw terminals		PU (UNIT, SET, M)	PS*
				Article No.	Price per PU		

Coordinate switches

Without mechanical interlock, 2 switch positions



3SU1100-7AC10-1NA0

2		Momentary contact	Horizontal	5	3SU1100-7AC10-1NA0		1	1 unit
			Vertical	5			3SU1100-7AD10-1NA0	1
	NEW	Latching	Horizontal	5	3SU1100-7AA10-1NA0		1	1 unit
			Vertical	5			3SU1100-7AB10-1NA0	1

Without mechanical interlock, 4 switch positions



3SU1100-7AF10-1QA0

4		Momentary contact	Horizontal/Vertical	3	3SU1100-7AF10-1QA0		1	1 unit
			Horizontal/Vertical	5			3SU1100-7AE10-1QA0	1

With mechanical interlock, 2 switch positions



3SU1100-7BA10-1NA0

2		Momentary contact	Horizontal	5	3SU1100-7BC10-1NA0		1	1 unit
			Vertical	5			3SU1100-7BD10-1NA0	1
	NEW	Latching	Horizontal	5	3SU1100-7BA10-1NA0		1	1 unit
			Vertical	5			3SU1100-7BB10-1NA0	1

With mechanical interlock, 4 switch positions



3SU1100-7BF10-1QA0

4		Momentary contact	Horizontal/Vertical	5	3SU1100-7BF10-1QA0		1	1 unit
			Horizontal/Vertical	5			3SU1100-7BE10-1QA0	1

3SU1 22 mm, Round, Plastic, Black — Complete Units

Indicator lights

Selection and ordering data

Operational voltage		Color of actuating element	Color of light source	SD	Screw terminals	PU (UNIT, SET, M)	PS*
at AC, rated value	at DC, rated value						
V	V			d	Article No.	Price per PU	

Indicator lights

With smooth lens and integrated LED



3SU1102-6AA30-1AA0

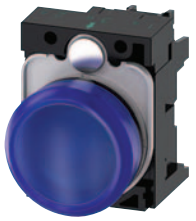

3SU1106-6AA50-1AA0

24	24	Red	Red	▶	3SU1102-6AA20-1AA0		1	1 unit
		Yellow	Yellow	▶	3SU1102-6AA30-1AA0		1	1 unit
		Green	Green	▶	3SU1102-6AA40-1AA0		1	1 unit
		Blue	Blue	▶	3SU1102-6AA50-1AA0		1	1 unit
		White	White	▶	3SU1102-6AA60-1AA0		1	1 unit
		Clear	White	▶	3SU1102-6AA70-1AA0		1	1 unit
110	--	Amber	Amber	5	3SU1103-6AA00-1AA0		1	1 unit
		Red	Red	▶	3SU1103-6AA20-1AA0		1	1 unit
		Yellow	Yellow	▶	3SU1103-6AA30-1AA0		1	1 unit
		Green	Green	▶	3SU1103-6AA40-1AA0		1	1 unit
		Blue	Blue	3	3SU1103-6AA50-1AA0		1	1 unit
		White	White	▶	3SU1103-6AA60-1AA0		1	1 unit
		Clear	White	3	3SU1103-6AA70-1AA0		1	1 unit
230	--	Amber	Amber	5	3SU1106-6AA00-1AA0		1	1 unit
		Red	Red	▶	3SU1106-6AA20-1AA0		1	1 unit
		Yellow	Yellow	▶	3SU1106-6AA30-1AA0		1	1 unit
		Green	Green	▶	3SU1106-6AA40-1AA0		1	1 unit
		Blue	Blue	3	3SU1106-6AA50-1AA0		1	1 unit
		White	White	▶	3SU1106-6AA60-1AA0		1	1 unit
		Clear	White	3	3SU1106-6AA70-1AA0		1	1 unit



3SU1102-6AA40-3AA0

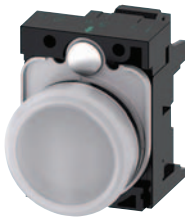

3SU1106-6AA60-3AA0

Operational voltage		Color of actuating element	Color of light source	SD	Spring-type terminals	PU (UNIT, SET, M)	PS*	
at AC, rated value	at DC, rated value							
V	V			d	Article No.	Price per PU		
24	24	Red	Red	3	3SU1102-6AA20-3AA0		1	1 unit
		Yellow	Yellow	5	3SU1102-6AA30-3AA0		1	1 unit
		Green	Green	3	3SU1102-6AA40-3AA0		1	1 unit
		Blue	Blue	5	3SU1102-6AA50-3AA0		1	1 unit
		White	White	3	3SU1102-6AA60-3AA0		1	1 unit
		Clear	White	5	3SU1102-6AA70-3AA0		1	1 unit
110	--	Red	Red	5	3SU1103-6AA20-3AA0		1	1 unit
		Yellow	Yellow	5	3SU1103-6AA30-3AA0		1	1 unit
		Green	Green	5	3SU1103-6AA40-3AA0		1	1 unit
		Blue	Blue	5	3SU1103-6AA50-3AA0		1	1 unit
		White	White	5	3SU1103-6AA60-3AA0		1	1 unit
		Clear	White	5	3SU1103-6AA70-3AA0		1	1 unit
230	--	Red	Red	5	3SU1106-6AA20-3AA0		1	1 unit
		Yellow	Yellow	5	3SU1106-6AA30-3AA0		1	1 unit
		Green	Green	5	3SU1106-6AA40-3AA0		1	1 unit
		Blue	Blue	5	3SU1106-6AA50-3AA0		1	1 unit
		White	White	5	3SU1106-6AA60-3AA0		1	1 unit
		Clear	White	5	3SU1106-6AA70-3AA0		1	1 unit

3SU1 22 mm, Round, Plastic, Black — Compact Units

Sensor switches / Potentiometers

Selection and ordering data

Operational voltage		Color of actuating element	Color of light source	SD	Screw terminals	PU (UNIT, SET, M)	PS*
at AC, rated value	at DC, rated value						
V	V			d	Article No.	Price per PU	

Indicator lights with "traffic light" LED **NEW**



3SU1201-6AG24-1AA0

6 ... 24	6 ... 24	Clear	Red/Yellow/Green	▶	3SU1201-6AG24-1AA0	1	1 unit
110	--	Clear	Red/Yellow/Green	▶	3SU1201-6AC24-1AA0	1	1 unit
230	--	Clear	Red/Yellow/Green	▶	3SU1201-6AF24-1AA0	1	1 unit

Selection and ordering data

Operational voltage		Volume level	SD	Screw terminals	PU (UNIT, SET, M)	PS*
at AC, rated value	at DC, rated value					
V	V	dB	d	Article No.	Price per PU	

Acoustic signaling devices **NEW**



3SU1200-6KB10-1AA0

24	24	90	5	▶	3SU1200-6KB10-1AA0	1	1 unit
110	110	90	5	▶	3SU1200-6KC10-1AA0	1	1 unit
230	230	90	5	▶	3SU1200-6KF10-1AA0	1	1 unit

Selection and ordering data

Operating principle	Number of NO contacts	Number of NC contacts	Color	SD	M12 connector, 4-pole	PU (UNIT, SET, M)	PS*

Sensor switches



3SU1200-1SK10-2SA0

Whether integrated in the two-hand operation console or installed as a door opening contact, the capacitive sensor switch is suitable for many different applications in industrial environments.

The switch is actuated by simple contact with the hand or other part of the body (i.e. without the application of pressure). As a result, these switches are rugged, extremely durable and have the highest possible degree of protection IP66, IP67, IP69 (IP69K).

Without pressure	1	0	Black	▶	3SU1200-1SK10-2SA0	1	1 unit
------------------	---	---	-------	---	---------------------------	---	--------

Optional accessories:

- "Protection for sensor switches", [see page 13/130](#).
- "Connectors for sensor switches, angled socket with screw terminal connection", [see page 13/138](#).

3SU1 22 mm, Round, Plastic, Black — Compact Units



Pushbuttons with extended stroke

Selection and ordering data

Version of actuating element	Operating principle	Adjustable resistance kΩ	SD d	Screw terminals		PU (UNIT, SET, M)	PS*
				Article No.	Price per PU		
Potentiometers							
 <p>3SU1200-2PQ10-1AA0</p>	Rotary knob	Stepless	▶	1	3SU1200-2PQ10-1AA0	1	1 unit
				2.2	3SU1200-2PW10-1AA0	1	1 unit
				4.7	3SU1200-2PR10-1AA0	1	1 unit
				10	3SU1200-2PS10-1AA0	1	1 unit
				47	3SU1200-2PT10-1AA0	1	1 unit
				100	3SU1200-2PU10-1AA0	1	1 unit
				470	3SU1200-2PV10-1AA0	1	1 unit

Labeling plates for potentiometers, see 13/126.

Selection and ordering data

Version	Color	SD d	Article No.	Price per PU	PU (UNIT, SET, M)	PS*	
Pushbuttons with extended stroke							
 <p>3SU1200-0EB20-0AA0</p>	For actuating relays, can only be combined with extension plunger, no contact module or LED module required						
	Pushbuttons with flat button	Red Green	5 5	3SU1200-0EB20-0AA0 3SU1200-0EB40-0AA0		1 1	1 unit 1 unit
 <p>3SU1200-0FB10-0AA0</p>	Pushbuttons with raised button	Black Red	▶ 5	3SU1200-0FB10-0AA0 3SU1200-0FB20-0AA0		1 1	1 unit 1 unit
	Mechanical reset kit - complete			3SU1200-0KB10-0AA0			
 <p>3SU1201-0EB70-0AA0</p>	Pushbuttons with flat transparent button for insertion of insert labels	Red Clear	▶ ▶	3SU1201-0EB20-0AA0 3SU1201-0EB70-0AA0		1 1	1 unit 1 unit

Version	Material	Color	SD d	Article No.	Price per PU	PU (UNIT, SET, M)	PS*
---------	----------	-------	---------	-------------	--------------	-------------------	-----

Accessories							
 <p>3SU1900-0KG10-0AA0</p>	Extension plungers	Plastic	Gray	▶	3SU1900-0KG10-0AA0	1	1 unit
	For compensation of the distance between the pushbutton and the unlatching button of an overload relay						

3SU1 22 mm, Round, Plastic, Black — Actuating & Signaling Elements

Pushbuttons

Selection and ordering data

Version of actuating element	Operating principle	Color, marking	SD	Article No.	Price per PU	PU (UNIT, SET, M)	PS*
Front ring version	Unlatching method		d				
Pushbuttons							
 3SU1000-0AB20-0AD0	Pushbuttons with flat button Standard	Momentary contact		Black	▶	3SU1000-0AB10-0AA0	1 1 unit
				Black, "O"	▶	3SU1000-0AB10-0AD0	1 1 unit
				Red	▶	3SU1000-0AB20-0AA0	1 1 unit
				Red, "O"	▶	3SU1000-0AB20-0AD0	1 1 unit
				Yellow	▶	3SU1000-0AB30-0AA0	1 1 unit
				Green	▶	3SU1000-0AB40-0AA0	1 1 unit
				Green, "I"	▶	3SU1000-0AB40-0AC0	1 1 unit
				Blue	▶	3SU1000-0AB50-0AA0	1 1 unit
				Blue, "R"	5	3SU1000-0AB50-0AR0	1 1 unit
				White	▶	3SU1000-0AB60-0AA0	1 1 unit
				White, "I"	▶	3SU1000-0AB60-0AC0	1 1 unit
				Clear	▶	3SU1000-0AB70-0AA0	1 1 unit
				Gray	▶	3SU1000-0AB80-0AA0	1 1 unit
		 3SU1000-0AA30-0AA0	Pushbuttons with latching button Push to unlatch	Latching		Black	▶
				Red	▶	3SU1000-0AA20-0AA0	1 1 unit
				Yellow	3	3SU1000-0AA30-0AA0	1 1 unit
				Green	▶	3SU1000-0AA40-0AA0	1 1 unit
				Blue	▶	3SU1000-0AA50-0AA0	1 1 unit
				White	▶	3SU1000-0AA60-0AA0	1 1 unit
 3SU1000-0BB30-0AA0	Pushbuttons with raised button Standard	Momentary contact		Black	▶	3SU1000-0BB10-0AA0	1 1 unit
				Red	▶	3SU1000-0BB20-0AA0	1 1 unit
				Yellow	5	3SU1000-0BB30-0AA0	1 1 unit
				Green	▶	3SU1000-0BB40-0AA0	1 1 unit
				Blue	▶	3SU1000-0BB50-0AA0	1 1 unit
				White	▶	3SU1000-0BB60-0AA0	1 1 unit
 3SU1000-0CB40-0AA0	Pushbuttons with raised button Raised	Momentary contact		Black	3	3SU1000-0CB10-0AA0	1 1 unit
				Red	5	3SU1000-0CB20-0AA0	1 1 unit
				Yellow	5	3SU1000-0CB30-0AA0	1 1 unit
				Green	5	3SU1000-0CB40-0AA0	1 1 unit
				Blue	5	3SU1000-0CB50-0AA0	1 1 unit
				White	5	3SU1000-0CB60-0AA0	1 1 unit
 3SU1000-0DB50-0AA0	Pushbuttons with raised button Raised, castellated	Momentary contact		Black	3	3SU1000-0DB10-0AA0	1 1 unit
				Red	5	3SU1000-0DB20-0AA0	1 1 unit
				Yellow	5	3SU1000-0DB30-0AA0	1 1 unit
				Green	5	3SU1000-0DB40-0AA0	1 1 unit
				Blue	5	3SU1000-0DB50-0AA0	1 1 unit
				White	5	3SU1000-0DB60-0AA0	1 1 unit

3SU1 22 mm, Round, Plastic, Black — Actuating & Signaling Elements





Pushbuttons

Version of actuating element Front ring version	Operating principle Unlatching method	Color	SD	Article No.	Price per PU	PU (UNIT, SET, M)	PS*
Pushbuttons							
 3SU1001-0AB40-0AA0	Illuminated pushbuttons with flat button Standard Momentary contact	Amber	5	3SU1001-0AB00-0AA0		1	1 unit
		Red	▶	3SU1001-0AB20-0AA0		1	1 unit
		Yellow	▶	3SU1001-0AB30-0AA0		1	1 unit
		Green	▶	3SU1001-0AB40-0AA0		1	1 unit
		Blue	▶	3SU1001-0AB50-0AA0		1	1 unit
		White	▶	3SU1001-0AB60-0AA0		1	1 unit
		Clear	▶	3SU1001-0AB70-0AA0		1	1 unit
		 3SU1001-0AA20-0AA0	Latching Push to unlatch	Red	▶	3SU1001-0AA20-0AA0	
Yellow	▶			3SU1001-0AA30-0AA0		1	1 unit
Green	▶			3SU1001-0AA40-0AA0		1	1 unit
Blue	▶			3SU1001-0AA50-0AA0		1	1 unit
White	▶			3SU1001-0AA60-0AA0		1	1 unit
Clear	▶			3SU1001-0AA70-0AA0		1	1 unit
 3SU1001-0BB70-0AA0	Illuminated pushbuttons with raised button Standard Momentary contact			Red	▶	3SU1001-0BB20-0AA0	
		Yellow	▶	3SU1001-0BB30-0AA0		1	1 unit
		Green	▶	3SU1001-0BB40-0AA0		1	1 unit
		Blue	▶	3SU1001-0BB50-0AA0		1	1 unit
		Clear	▶	3SU1001-0BB70-0AA0		1	1 unit
 3SU1001-0DB50-0AA0	Illuminated pushbuttons with flat button Raised, castellated Momentary contact	Blue	5	3SU1001-0DB50-0AA0		1	1 unit
 3SU1000-0HC10-0AA0	Stop pushbuttons Standard Momentary contact, latching by pressing in and turning to the right, rotate-to-unlatch to the left	Black	3	3SU1000-0HC10-0AA0		1	1 unit
		Red	3	3SU1000-0HC20-0AA0		1	1 unit

3SU1 22 mm, Round, Plastic, Black — Actuating & Signaling Elements

Twin pushbuttons

Selection and ordering data

Version of actuating element	Operating principle	Color	Marking Symbol No.	SD	Article No.	Price per PU	PU (UNIT, SET, M)	PS*		
Twin pushbuttons										
 <p>3SU1000-3AB66-0AL0</p>	Twin pushbuttons flat, flat	Momentary contact	Green/Red	--	3	3SU1000-3AB42-0AA0	1	1 unit		
			White/Black	"I"/"O"	▶	3SU1000-3AB42-0AK0			1	1 unit
			White/Black	--	▶	3SU1000-3AB61-0AA0			1	1 unit
			White/Black	"I"/"O"	▶	3SU1000-3AB61-0AK0			1	1 unit
			White/White	--	3	3SU1000-3AB66-0AA0			1	1 unit
			"-"/"+"	5	3SU1000-3AB66-0AL0	1			1 unit	
			Arrows, hor.	5	3SU1000-3AB66-0AM0	1			1 unit	
			Arrows, vert.	5	3SU1000-3AB66-0AN0	1			1 unit	
			Black/Black	--	3	3SU1000-3AB11-0AA0			1	1 unit
			○	3	3SU1000-3AB11-0AQ0	1			1 unit	
			5264/5265 (IEC 60417)							
 <p>3SU1000-3BB42-0AK0</p>	Twin pushbuttons flat, raised	Momentary contact	Green/Red	--	3	3SU1000-3BB42-0AA0	1	1 unit		
			White/Black	"I"/"O"	▶	3SU1000-3BB42-0AK0			1	1 unit
			White/Black	--	▶	3SU1000-3BB61-0AA0			1	1 unit
			"I"/"O"	5	3SU1000-3BB61-0AK0	1	1 unit			
 <p>3SU1001-3AB42-0AN0</p>	Twin pushbuttons flat, flat, illuminated	Momentary contact	Green/Red	--	▶	3SU1001-3AB42-0AA0	1	1 unit		
			White/Black	"I"/"O"	▶	3SU1001-3AB42-0AK0			1	1 unit
			White/Black	Arrows, vert.	3	3SU1001-3AB42-0AN0			1	1 unit
			White/Black	--	▶	3SU1001-3AB61-0AA0			1	1 unit
			White/Black	"I"/"O"	▶	3SU1001-3AB61-0AK0			1	1 unit
			White/White	--	▶	3SU1001-3AB66-0AA0			1	1 unit
			"-"/"+"	5	3SU1001-3AB66-0AL0	1			1 unit	
			Arrows, vert.	5	3SU1001-3AB66-0AN0	1			1 unit	
			Symbols	5	3SU1001-3AB66-0AP0	1			1 unit	
"Circular saw blade"/ "Tilt tipper"										
 <p>3SU1001-3BB61-0AK0</p>	Twin pushbuttons flat, raised, illuminated	Momentary contact	Green/Red	--	3	3SU1001-3BB42-0AA0	1	1 unit		
			White/Black	"I"/"O"	▶	3SU1001-3BB42-0AK0			1	1 unit
			White/Black	--	▶	3SU1001-3BB61-0AA0			1	1 unit
			"I"/"O"	3	3SU1001-3BB61-0AK0	1	1 unit			

3SU1 22 mm, Round, Plastic, Black — Actuating & Signaling Elements

Mushroom pushbuttons





Selection and ordering data

Version of actuating element	Operating principle Unlatching method	Color, marking	SD	Article No.	Price per PU	PU (UNIT, SET, M)	PS*
Mushroom pushbuttons							
 <p>Mushroom pushbuttons 30 mm diameter, 2 positions</p> <p>3SU1000-1AD20-0AA0</p>	Momentary contact	Black	▶	3SU1000-1AD10-0AA0		1	1 unit
		Red	▶	3SU1000-1AD20-0AA0		1	1 unit
		Yellow	▶	3SU1000-1AD30-0AA0		1	1 unit
		Green	▶	3SU1000-1AD40-0AA0		1	1 unit
	Latching Pull to unlatch	Black	▶	3SU1000-1AA10-0AA0		1	1 unit
		Red	▶	3SU1000-1AA20-0AA0		1	1 unit
Yellow		5	3SU1000-1AA30-0AA0		1	1 unit	
 <p>Mushroom pushbuttons 40 mm diameter, 2 positions</p> <p>3SU1000-1BD40-0AA0</p>	Momentary contact	Black	▶	3SU1000-1BD10-0AA0		1	1 unit
		Red	▶	3SU1000-1BD20-0AA0		1	1 unit
		Yellow	3	3SU1000-1BD30-0AA0		1	1 unit
		Green	▶	3SU1000-1BD40-0AA0		1	1 unit
	Latching Pull to unlatch	Black	▶	3SU1000-1BA10-0AA0		1	1 unit
		Red	▶	3SU1000-1BA20-0AA0		1	1 unit
Red "O"		▶	3SU1000-1BA20-0AD0		1	1 unit	
		Yellow	3	3SU1000-1BA30-0AA0		1	1 unit
		Green	5	3SU1000-1BA40-0AA0		1	1 unit
 <p>Mushroom pushbuttons 60 mm diameter, 2 positions</p> <p>3SU1000-1CD10-0AA0</p>	Momentary contact	Black	3	3SU1000-1CD10-0AA0		1	1 unit
		Red	5	3SU1000-1CD20-0AA0		1	1 unit
		Yellow	5	3SU1000-1CD30-0AA0		1	1 unit
		Green	3	3SU1000-1CD40-0AA0		1	1 unit
	Latching Pull to unlatch	Black	5	3SU1000-1CA10-0AA0		1	1 unit
		Red	5	3SU1000-1CA20-0AA0		1	1 unit
 <p>Mushroom pushbuttons 30 mm diameter, 2 positions, illuminated</p> <p>3SU1001-1AD30-0AA0</p>	Momentary contact	Red	5	3SU1001-1AD20-0AA0		1	1 unit
		Yellow	3	3SU1001-1AD30-0AA0		1	1 unit
		Green	3	3SU1001-1AD40-0AA0		1	1 unit
		Blue	5	3SU1001-1AD50-0AA0		1	1 unit
		White	3	3SU1001-1AD60-0AA0		1	1 unit
		Clear	5	3SU1001-1AD70-0AA0		1	1 unit
Latching Pull to unlatch	Red	▶	3SU1001-1AA20-0AA0		1	1 unit	
	Yellow	3	3SU1001-1AA30-0AA0		1	1 unit	
	Green	5	3SU1001-1AA40-0AA0		1	1 unit	
	Blue	3	3SU1001-1AA50-0AA0		1	1 unit	
	Clear	5	3SU1001-1AA70-0AA0		1	1 unit	
	 <p>Mushroom pushbuttons 40 mm diameter, 2 positions, illuminated</p> <p>3SU1001-1BA50-0AA0</p>	Momentary contact	Yellow	3	3SU1001-1BD30-0AA0		1
Green			3	3SU1001-1BD40-0AA0		1	1 unit
White			3	3SU1001-1BD60-0AA0		1	1 unit
Clear			3	3SU1001-1BD70-0AA0		1	1 unit
Latching Pull to unlatch		Red	▶	3SU1001-1BA20-0AA0		1	1 unit
		Yellow	3	3SU1001-1BA30-0AA0		1	1 unit
	Green	5	3SU1001-1BA40-0AA0		1	1 unit	
	Blue	3	3SU1001-1BA50-0AA0		1	1 unit	
	Clear	5	3SU1001-1BA70-0AA0		1	1 unit	
 <p>Mushroom pushbuttons 40 mm diameter, 2 positions</p> <p>3SU1000-1HB10-0AA0</p>	With positive latching, tamper-proof Rotate to unlatch	Black	▶	3SU1000-1HB10-0AA0		1	1 unit
		Blue	3	3SU1000-1HB50-0AA0		1	1 unit

3SU1 22 mm, Round, Plastic, Black — Actuating & Signaling Elements

EMERGENCY STOP mushroom pushbuttons

Selection and ordering data

Version of actuating element	Outer diameter of mushroom mm	Make of lock	Color	SD	Article No.	Price per PU	PU (UNIT, SET, M)	PS*	
EMERGENCY STOP mushroom pushbuttons, in accordance with ISO 13850 and IEC 60947-5-5									
With pull-to-unlatch mechanism									
 3SU1000-1HA20-0AA0	Tamper-proof, 2 positions	40	--	Red	▶	3SU1000-1HA20-0AA0	1	1 unit	
With rotate-to-unlatch mechanism									
 3SU1000-1GB20-0AA0	Tamper-proof, 2 positions	33.8	--	Red	▶	3SU1000-1GB20-0AA0	1	1 unit	
 3SU1000-1HB20-0AA0		40	--	Red	▶	3SU1000-1HB20-0AA0	1	1 unit	
 3SU1000-1JB20-0AA0		60	--	Red	▶	3SU1000-1JB20-0AA0	1	1 unit	
With rotate-to-unlatch mechanism, can be illuminated									
 3SU1001-1HB20-0AA0	Tamper-proof, 2 positions	33.8	--	Red	▶	3SU1001-1GB20-0AA0 3SU1001-1HB20-0AA0 3SU1001-1JB20-0AA0	1	1 unit	
		40	--	Red	▶			1	1 unit
		60	--	Red	▶			1	1 unit

3SU1 22 mm, Round, Plastic, Black — Actuating & Signaling Elements

EMERGENCY STOP mushroom pushbuttons

Version of actuating element	Outer diameter of mushroom mm	Make of lock	Color	Number of keys	SD	Article No.	Price per PU	PU (UNIT, SET, M)	PS*
------------------------------	----------------------------------	--------------	-------	----------------	----	-------------	--------------	-------------------	-----

EMERGENCY STOP mushroom pushbuttons, in accordance with ISO 13850 and IEC 60947-5-5

With key-operated release



3SU1000-1HF20-0AA0



3SU1000-1HK20-0AA0



3SU1000-1HQ20-0AA0



3SU1000-1HR20-0AA0

Tamper-proof, 2 positions	40	RONIS SB30	Red	2	▶	3SU1000-1HF20-0AA0		1	1 unit
		RONIS 455	Red	2	3	3SU1000-1HG20-0AA0		1	1 unit
		BKS S1	Red	2	▶	3SU1000-1HK20-0AA0		1	1 unit
		BKS E7	Red	0	3	3SU1000-1HM20-0AA0		1	1 unit
		BKS E9	Red	0	3	3SU1000-1HN20-0AA0		1	1 unit
		O.M.R. 73037	Red	2	▶	3SU1000-1HQ20-0AA0		1	1 unit
		CES SSG10	Red	2	▶	3SU1000-1HR20-0AA0		1	1 unit
		CES SSP9	Red	2	▶	3SU1000-1HS20-0AA0		1	1 unit
		CES SMS1	Red	2	3	3SU1000-1HT20-0AA0		1	1 unit

Selection and ordering data

Number of switching positions	Number of command points	Color of actuating element	Operating principle of the actuating element	SD	Article No.	Price per PU	PU (UNIT, SET, M)	PS*
-------------------------------	--------------------------	----------------------------	--	----	-------------	--------------	-------------------	-----

Toggle switches



3SU1000-3EA10-0AA0

2	1	Black	Latching	3	3SU1000-3EA10-0AA0		1	1 unit
			Momentary contact, reset from above	3	3SU1000-3EC10-0AA0		1	1 unit

3SU1 22 mm, Round, Plastic, Black — Actuating & Signaling Elements

Selector switches

Selection and ordering data

Version of actuating element	Operating principle	Color	SD	Article No.	Price per PU	PU (UNIT, SET, M)	PS*
------------------------------	---------------------	-------	----	-------------	--------------	-------------------	-----

Selector switches

2 switch positions, can be illuminated

Selector, short black actuator

Momentary contact, 45° (10:30/12 o'clock), reset from center to left



- ▶ Black
- ▶ Red
- ▶ Yellow
- ▶ Green
- ▶ Blue
- ▶ White

- ▶ **3SU1002-2BC10-0AA0**
- ▶ **3SU1002-2BC20-0AA0**
- ▶ **3SU1002-2BC30-0AA0**
- ▶ **3SU1002-2BC40-0AA0**
- ▶ **3SU1002-2BC50-0AA0**
- ▶ **3SU1002-2BC60-0AA0**

- 1 1 unit
- 1 1 unit
- 1 1 unit
- 1 1 unit
- 1 1 unit
- 1 1 unit



3SU1002-2BC40-0AA0



3SU1002-2BF30-0AA0



3SU1002-2CF20-0AA0



3SU1002-2AF20-0AA0

Latching, 90° (10:30/1:30 o'clock)



- ▶ Black
- ▶ Red
- ▶ Yellow
- ▶ Green
- ▶ Blue
- ▶ White

- ▶ **3SU1002-2BF10-0AA0**
- ▶ **3SU1002-2BF20-0AA0**
- ▶ **3SU1002-2BF30-0AA0**
- ▶ **3SU1002-2BF40-0AA0**
- ▶ **3SU1002-2BF50-0AA0**
- ▶ **3SU1002-2BF60-0AA0**

- 1 1 unit
- 1 1 unit
- 1 1 unit
- 1 1 unit
- 1 1 unit
- 1 1 unit

Selector, long black actuator

Latching, 90° (10:30/1:30 o'clock)



- 3 Black
- 3 Red
- 3 White

- ▶ **3SU1002-2CF10-0AA0**
- ▶ **3SU1002-2CF20-0AA0**
- ▶ **3SU1002-2CF60-0AA0**

- 1 1 unit
- 1 1 unit
- 1 1 unit

Rotary knob

Latching, 90° (10:30/1:30 o'clock)



- 3 Red
- ▶ White

- ▶ **3SU1002-2AF20-0AA0**
- ▶ **3SU1002-2AF60-0AA0**

- 1 1 unit
- 1 1 unit

3SU1 22 mm, Round, Plastic, Black — Actuating & Signaling Elements

Selector switches

Version of actuating element	Operating principle	Color	SD	Article No.	Price per PU	PU (UNIT, SET, M)	PS*
------------------------------	---------------------	-------	----	-------------	--------------	-------------------	-----

Selector switches

3 switch positions, can be illuminated



3SU1002-2BM20-0AA0

Selector, short black actuator

Momentary contact, 2x45° (10:30/12/1:30 o'clock), reset from left + right



- ▶ Black
- ▶ Red
- ▶ Yellow
- ▶ Green
- ▶ Blue
- ▶ White

- ▶ 3SU1002-2BM10-0AA0
- ▶ 3SU1002-2BM20-0AA0
- ▶ 3SU1002-2BM30-0AA0
- ▶ 3SU1002-2BM40-0AA0
- ▶ 3SU1002-2BM50-0AA0
- ▶ 3SU1002-2BM60-0AA0

- 1 1 unit
- 1 1 unit
- 1 1 unit
- 1 1 unit
- 1 1 unit
- 1 1 unit



3SU1002-2BL60-0AA0

Latching, 2x45° (10:30/12/1:30 o'clock)



- ▶ Black
- ▶ Red
- ▶ Yellow
- ▶ Green
- ▶ Blue
- ▶ White

- ▶ 3SU1002-2BL10-0AA0
- ▶ 3SU1002-2BL20-0AA0
- ▶ 3SU1002-2BL30-0AA0
- ▶ 3SU1002-2BL40-0AA0
- ▶ 3SU1002-2BL50-0AA0
- ▶ 3SU1002-2BL60-0AA0

- 1 1 unit
- 1 1 unit
- 1 1 unit
- 1 1 unit
- 1 1 unit
- 1 1 unit



3SU1002-2BP50-0AA0

Momentary contact/latching, 2x45° (10:30/12/1:30 o'clock), reset from left, latching to the right



- ▶ Black
- ▶ Red
- ▶ Yellow
- ▶ Green
- ▶ Blue
- ▶ White

- ▶ 3SU1002-2BP10-0AA0
- ▶ 3SU1002-2BP20-0AA0
- ▶ 3SU1002-2BP30-0AA0
- ▶ 3SU1002-2BP40-0AA0
- ▶ 3SU1002-2BP50-0AA0
- ▶ 3SU1002-2BP60-0AA0

- 1 1 unit
- 1 1 unit
- 1 1 unit
- 1 1 unit
- 1 1 unit
- 1 1 unit



3SU1002-2BN30-0AA0

Latching/momentary contact, 2x45° (10:30/12/1:30 o'clock), reset from right, latching to the left



- ▶ Black
- ▶ Red
- ▶ Yellow
- ▶ Green
- ▶ Blue
- ▶ White

- ▶ 3SU1002-2BN10-0AA0
- ▶ 3SU1002-2BN20-0AA0
- ▶ 3SU1002-2BN30-0AA0
- ▶ 3SU1002-2BN40-0AA0
- ▶ 3SU1002-2BN50-0AA0
- ▶ 3SU1002-2BN60-0AA0

- 1 1 unit
- 1 1 unit
- 1 1 unit
- 1 1 unit
- 1 1 unit
- 1 1 unit

4 switch positions



3SU1000-2AS60-0AA0

Rotary knob

Latching, 4x90° (3/6/9/12 o'clock)



- ▶ White

- ▶ 3SU1000-2AS60-0AA0

- 1 1 unit

3SU1 22 mm, Round, Plastic, Black — Actuating & Signaling Elements

Key-operated switches

Selection and ordering data

Operating principle	Make of lock	Switch position for key removal	Number of keys	SD	Article No.	Price per PU	PU (UNIT, SET, M)	PS*
---------------------	--------------	---------------------------------	----------------	----	-------------	--------------	-------------------	-----

Key-operated switches

2 switch positions

Momentary contact, 45° (10:30/12 o'clock), reset from center to left



3SU1000-4JC01-0AA0

Latching, 90° (10:30/1:30 o'clock)



3SU1000-4BF11-0AA0



3SU1000-4GF11-0AA0



3SU1000-5BF11-0AA0



3SU1000-5PF11-0AA0

RONIS, SB30	O	2	▶	3SU1000-4BC01-0AA0	1	1 unit
RONIS, 455	O	2	5	3SU1000-4CC01-0AA0	1	1 unit
O.M.R. 73037, red	O	2	3	3SU1000-4FC01-0AA0	1	1 unit
O.M.R. 73038, light blue	O	2	3	3SU1000-4GC01-0AA0	1	1 unit
O.M.R. 73034, black	O	2	3	3SU1000-4HC01-0AA0	1	1 unit
O.M.R. 73033, yellow	O	2	3	3SU1000-4JC01-0AA0	1	1 unit
CES, SSG10	O	2	▶	3SU1000-5BC01-0AA0	1	1 unit
CES, LSG1		2	3	3SU1000-5HC01-0AA0	1	1 unit
BKS, S1	O	2	▶	3SU1000-5PC01-0AA0	1	1 unit
IKON, 360012K1	O	2	▶	3SU1000-5XC01-0AA0	1	1 unit
RONIS, SB30	O	2	▶	3SU1000-4BF01-0AA0	1	1 unit
	O+l	2	▶	3SU1000-4BF11-0AA0	1	1 unit
	l	2	▶	3SU1000-4BF21-0AA0	1	1 unit
RONIS, 455	O	2	3	3SU1000-4CF01-0AA0	1	1 unit
	O+l	2	3	3SU1000-4CF11-0AA0	1	1 unit
RONIS, 421	O+l	2	5	3SU1000-4DF11-0AA0	1	1 unit
O.M.R. 73037, red	O	2	3	3SU1000-4FF01-0AA0	1	1 unit
	O+l	2	3	3SU1000-4FF11-0AA0	1	1 unit
O.M.R. 73038, light blue	O	2	▶	3SU1000-4GF01-0AA0	1	1 unit
	O+l	2	3	3SU1000-4GF11-0AA0	1	1 unit
O.M.R. 73034, black	O	2	3	3SU1000-4HF01-0AA0	1	1 unit
	O+l	2	3	3SU1000-4HF11-0AA0	1	1 unit
	l	2	5	3SU1000-4HF21-0AA0	1	1 unit
O.M.R. 73033, yellow	O	2	3	3SU1000-4JF01-0AA0	1	1 unit
	O+l	2	3	3SU1000-4JF11-0AA0	1	1 unit
CES, SSG10	O	2	▶	3SU1000-5BF01-0AA0	1	1 unit
	O+l	2	▶	3SU1000-5BF11-0AA0	1	1 unit
	l	2	▶	3SU1000-5BF21-0AA0	1	1 unit
CES, LSG1	O	2	▶	3SU1000-5HF01-0AA0	1	1 unit
	O+l	2	▶	3SU1000-5HF11-0AA0	1	1 unit
BKS, S1	O	2	▶	3SU1000-5PF01-0AA0	1	1 unit
	O+l	2	▶	3SU1000-5PF11-0AA0	1	1 unit
	l	2	3	3SU1000-5PF21-0AA0	1	1 unit
BKS, E1	O	0	3	3SU1000-5QF01-0AA0	1	1 unit
	O+l	0	3	3SU1000-5QF11-0AA0	1	1 unit
BKS, E2	O	0	▶	3SU1000-5RF01-0AA0	1	1 unit
	O+l	0	3	3SU1000-5RF11-0AA0	1	1 unit
BKS, E7	O	0	▶	3SU1000-5SF01-0AA0	1	1 unit
	O+l	0	▶	3SU1000-5SF11-0AA0	1	1 unit
BKS, E9	O	0	▶	3SU1000-5TF01-0AA0	1	1 unit
	O+l	0	3	3SU1000-5TF11-0AA0	1	1 unit
IKON, 360012K1	O	2	▶	3SU1000-5XF01-0AA0	1	1 unit
	O+l	2	▶	3SU1000-5XF11-0AA0	1	1 unit

3SU1 22 mm, Round, Plastic, Black — Actuating & Signaling Elements

Key-operated switches

Operating principle	Make of lock	Switch position for key removal	Number of keys	SD	Article No.	Price per PU	PU (UNIT, SET, M)	PS*
---------------------	--------------	---------------------------------	----------------	----	-------------	--------------	-------------------	-----

Key-operated switches

3 switch positions

Momentary contact, 2x45° (10:30/12/1:30 o'clock), reset from left + right



3SU1000-4BM01-0AA0

Latching, 2x45° (10:30/12/1:30 o'clock)



3SU1000-4FL01-0AA0



3SU1000-5BL01-0AA0



3SU1000-5PL01-0AA0

RONIS, SB30	O	2	▶	3SU1000-4BM01-0AA0	1	1 unit
O.M.R. 73037, red	O	2	5	3SU1000-4FM01-0AA0	1	1 unit
O.M.R. 73034, black	O	2	5	3SU1000-4HM01-0AA0	1	1 unit
CES, SSG10	O	2	▶	3SU1000-5BM01-0AA0	1	1 unit
BKS, S1	O	2	3	3SU1000-5PM01-0AA0	1	1 unit
IKON, 360012K1	O	2	3	3SU1000-5XM01-0AA0	1	1 unit
RONIS, SB30	O	2	3	3SU1000-4BL01-0AA0	1	1 unit
	I+O+II	2	▶	3SU1000-4BL11-0AA0	1	1 unit
	I	2	5	3SU1000-4BL21-0AA0	1	1 unit
	II	2	3	3SU1000-4BL31-0AA0	1	1 unit
	I+II	2	3	3SU1000-4BL41-0AA0	1	1 unit
	O+I	2	3	3SU1000-4BL51-0AA0	1	1 unit
RONIS, 455	O	2	5	3SU1000-4CL01-0AA0	1	1 unit
	I+O+II	2	3	3SU1000-4CL11-0AA0	1	1 unit
O.M.R. 73037, red	O	2	5	3SU1000-4FL01-0AA0	1	1 unit
	O+I	2	5	3SU1000-4FL51-0AA0	1	1 unit
O.M.R. 73038, light blue	O	2	3	3SU1000-4GL01-0AA0	1	1 unit
	I+O+II	2	3	3SU1000-4GL11-0AA0	1	1 unit
O.M.R. 73034, black	O	2	5	3SU1000-4HL01-0AA0	1	1 unit
	I+O+II	2	3	3SU1000-4HL11-0AA0	1	1 unit
O.M.R. 73033, yellow	I+O+II	2	5	3SU1000-4JL11-0AA0	1	1 unit
CES, SSG10	O	▶	3SU1000-5BL01-0AA0	1	1 unit	
	I+O+II	2	▶	3SU1000-5BL11-0AA0	1	1 unit
	I	2	3	3SU1000-5BL21-0AA0	1	1 unit
	II	2	3	3SU1000-5BL31-0AA0	1	1 unit
	I+II	2	3	3SU1000-5BL41-0AA0	1	1 unit
	O+I	2	3	3SU1000-5BL51-0AA0	1	1 unit
BKS, S1	O	2	3	3SU1000-5PL01-0AA0	1	1 unit
	I+O+II	2	3	3SU1000-5PL11-0AA0	1	1 unit
	I	2	3	3SU1000-5PL21-0AA0	1	1 unit
	II	2	3	3SU1000-5PL31-0AA0	1	1 unit
	I+II	2	3	3SU1000-5PL41-0AA0	1	1 unit
BKS, E2	I+O+II	0	5	3SU1000-5RL11-0AA0	1	1 unit
BKS, E9	I+O+II	0	3	3SU1000-5TL11-0AA0	1	1 unit
IKON, 360012K1	O	2	3	3SU1000-5XL01-0AA0	1	1 unit
	I+O+II	2	3	3SU1000-5XL11-0AA0	1	1 unit

3SU1 22 mm, Round, Plastic, Black — Actuating & Signaling Elements

Key-operated switches / ID key-operated switches

Operating principle	Make of lock	Switch position for key removal	Number of keys	SD	Article No.	Price per PU	PU (UNIT, SET, M)	PS*
---------------------	--------------	---------------------------------	----------------	----	-------------	--------------	-------------------	-----

Key-operated switches

3 switch positions



3SU1000-4BP01-0AA0

Momentary contact/latching, 2x45° (10:30/12/1:30 o'clock), reset from left, latching to the right



RONIS, SB30	O	2	3	3SU1000-4BP01-0AA0	1	1 unit
	II	2	3	3SU1000-4BP31-0AA0	1	1 unit
	O+II	2	3	3SU1000-4BP61-0AA0	1	1 unit



3SU1000-5BP01-0AA0

CES, SSG10	O	2	3	3SU1000-5BP01-0AA0	1	1 unit
	II	2	5	3SU1000-5BP31-0AA0	1	1 unit
	O+II	2	3	3SU1000-5BP61-0AA0	1	1 unit
BKS, S1	O	2	3	3SU1000-5PP01-0AA0	1	1 unit



3SU1000-4GN01-0AA0

Latching/momentary contact, 2x45° (10:30/12/1:30 o'clock), reset from right, latching to the left



RONIS, SB30	O	2	3	3SU1000-4BN01-0AA0	1	1 unit
	I	2	3	3SU1000-4BN21-0AA0	1	1 unit
	O+I	2	3	3SU1000-4BN51-0AA0	1	1 unit
O.M.R. 73038, light blue	O	2	5	3SU1000-4GN01-0AA0	1	1 unit
O.M.R. 73034, black	I	2	5	3SU1000-4HN21-0AA0	1	1 unit
CES, SSG10	O	2	3	3SU1000-5BN01-0AA0	1	1 unit
	I	2	3	3SU1000-5BN21-0AA0	1	1 unit
	O+I	2	3	3SU1000-5BN51-0AA0	1	1 unit
BKS, S1	I	2	5	3SU1000-5PN21-0AA0	1	1 unit
	O+I	2	3	3SU1000-5PN51-0AA0	1	1 unit
IKON, 360012K1	O+I	2	5	3SU1000-5XN51-0AA0	1	1 unit

Selection and ordering data

Operating angle	Operating principle	Switch position for key removal	Color	SD	Article No.	Price per PU	PU (UNIT, SET, M)	PS*
-----------------	---------------------	---------------------------------	-------	----	-------------	--------------	-------------------	-----

ID key-operated switches

4 switch positions



3SU1000-4WS10-0AA0

45° Latching Key removal possible in all 4 positions Black

3SU1000-4WS10-0AA0	1	1 unit
---------------------------	---	--------



For available keys, see page 10/152

For electronic modules for ID key-operated switches, see page 10/115



3SU1 22 mm, Round, Plastic, Black — Actuating & Signaling Elements

Indicator lights

Selection and ordering data

Product function Locking in zero position	Number of switching positions	Operating principle	Direction of actuation	SD	Article No.	Price per PU	PU (UNIT, SET, M)	PS*
Coordinate switches								
 3SU1000-7AA10-0AA0  3SU1000-7BA10-0AA0	No	2	Momentary contact	Horizontal Vertical	▶ 3SU1000-7AC10-0AA0 ▶ 3SU1000-7AD10-0AA0		1	1 unit
		NEW	Latching	Horizontal Vertical	▶ 3SU1000-7AA10-0AA0 ▶ 3SU1000-7AB10-0AA0		1	1 unit
		4	Momentary contact	Horizontal/ Ver- tical	▶ 3SU1000-7AF10-0AA0		1	1 unit
		NEW	Latching	Horizontal/ Ver- tical	▶ 3SU1000-7AE10-0AA0		1	1 unit
	Yes	2	Momentary contact	Horizontal Vertical	▶ 3SU1000-7BC10-0AA0 ▶ 3SU1000-7BD10-0AA0		1	1 unit
		NEW	Latching	Horizontal Vertical	▶ 3SU1000-7BA10-0AA0 ▶ 3SU1000-7BB10-0AA0		1	1 unit
		4	Momentary contact	Horizontal/ Ver- tical	▶ 3SU1000-7BF10-0AA0		1	1 unit
		NEW	Latching	Horizontal/ Ver- tical	▶ 3SU1000-7BE10-0AA0		1	1 unit

Selection and ordering data

Type of product	Color	SD	Article No.	Price per PU	PU (UNIT, SET, M)	PS*
Indicator lights						
 3SU1001-6AA40-0AA0	With smooth lens	Amber	▶ 3SU1001-6AA00-0AA0		1	1 unit
		Red	▶ 3SU1001-6AA20-0AA0		1	1 unit
		Yellow	▶ 3SU1001-6AA30-0AA0		1	1 unit
		Green	▶ 3SU1001-6AA40-0AA0		1	1 unit
		Blue	▶ 3SU1001-6AA50-0AA0		1	1 unit
		White	▶ 3SU1001-6AA60-0AA0		1	1 unit
		Clear	▶ 3SU1001-6AA70-0AA0		1	1 unit
	Indicator lights in illuminated pushbutton design NEW					
 3SU1001-0AD50-0AA0	--	Red	▶ 3SU1001-0AD20-0AA0		1	1 unit
		Yellow	▶ 3SU1001-0AD30-0AA0		1	1 unit
		Green	▶ 3SU1001-0AD40-0AA0		1	1 unit
		Blue	▶ 3SU1001-0AD50-0AA0		1	1 unit
		Clear	▶ 3SU1001-0AD70-0AA0		1	1 unit

3SU1 22 mm, Plastic with Metal Front Ring, Matte — Complete Units

Pushbuttons

Selection and ordering data

Supply voltage for light source		Color	Number of			SD	Screw terminals	PU (UNIT, SET, M)	PS*
At AC	At DC		Contact modules	NO contacts	NC contacts				
V	V					Article No.	Price per PU		

Pushbuttons

Pushbuttons with flat button, momentary contact



3SU1130-0AB10-1BA0

--	--	Black	1	1	0	▶	3SU1130-0AB10-1BA0	1	1 unit
				0	1	3	3SU1130-0AB10-1CA0	1	1 unit
				1	1	▶	3SU1130-0AB10-1FA0	1	1 unit
		Red	1	1	0	5	3SU1130-0AB20-1BA0	1	1 unit
				0	1	▶	3SU1130-0AB20-1CA0	1	1 unit
				1	1	▶	3SU1130-0AB20-1FA0	1	1 unit
		Yellow	1	1	0	5	3SU1130-0AB30-1BA0	1	1 unit
				1	1	5	3SU1130-0AB30-1FA0	1	1 unit
		Green	1	1	0	▶	3SU1130-0AB40-1BA0	1	1 unit
				1	1	▶	3SU1130-0AB40-1FA0	1	1 unit
		Blue	1	1	0	3	3SU1130-0AB50-1BA0	1	1 unit
				1	1	5	3SU1130-0AB50-1FA0	1	1 unit
		White	1	1	0	3	3SU1130-0AB60-1BA0	1	1 unit
				1	1	5	3SU1130-0AB60-1FA0	1	1 unit

Pushbuttons with raised button, momentary contact



3SU1130-0BB20-1CA0

--	--	Red	1	0	1	5	3SU1130-0BB20-1CA0	1	1 unit
----	----	-----	---	---	---	---	--------------------	---	--------

Illuminated pushbuttons with flat button, momentary contact with integrated LED



3SU1132-0AB40-1BA0

24	24	Red	1	1	0	5	3SU1132-0AB20-1BA0	1	1 unit
				0	1	3	3SU1132-0AB20-1CA0	1	1 unit
				1	1	3	3SU1132-0AB20-1FA0	1	1 unit
		Yellow	1	1	0	3	3SU1132-0AB30-1BA0	1	1 unit
				1	1	5	3SU1132-0AB30-1FA0	1	1 unit
		Green	1	1	0	▶	3SU1132-0AB40-1BA0	1	1 unit
				1	1	3	3SU1132-0AB40-1FA0	1	1 unit
		Blue	1	1	0	3	3SU1132-0AB50-1BA0	1	1 unit
				1	1	5	3SU1132-0AB50-1FA0	1	1 unit
		White	1	1	0	▶	3SU1132-0AB60-1BA0	1	1 unit
				1	1	3	3SU1132-0AB60-1FA0	1	1 unit
		Clear	1	1	0	3	3SU1132-0AB70-1BA0	1	1 unit
				1	1	5	3SU1132-0AB70-1FA0	1	1 unit
110	--	Red	1	0	1	5	3SU1133-0AB20-1CA0	1	1 unit
				1	1	5	3SU1133-0AB20-1FA0	1	1 unit
		Yellow	1	1	0	5	3SU1133-0AB30-1BA0	1	1 unit
				1	1	5	3SU1133-0AB30-1FA0	1	1 unit
		Green	1	1	0	5	3SU1133-0AB40-1BA0	1	1 unit
				1	1	5	3SU1133-0AB40-1FA0	1	1 unit
		Blue	1	1	0	5	3SU1133-0AB50-1BA0	1	1 unit
				1	1	5	3SU1133-0AB50-1FA0	1	1 unit
		White	1	1	0	5	3SU1133-0AB60-1BA0	1	1 unit
				1	1	5	3SU1133-0AB60-1FA0	1	1 unit
		Clear	1	1	0	5	3SU1133-0AB70-1BA0	1	1 unit
				1	1	5	3SU1133-0AB70-1FA0	1	1 unit

3SU1 22 mm, Plastic with Metal Front Ring, Matte — Complete Units

Actuators and Indicator

Supply voltage for light source		Color	Number of			SD	Screw terminals 	PU (UNIT, SET, M)	PS*
At AC	At DC		Contact modules	NO contacts	NC contacts				
V	V					Article No.	Price per PU		

Pushbuttons

Illuminated pushbuttons with flat button, momentary contact with integrated LED



3SU1136-0AB40-1BA0

230	--	Red	1	0	1	5	3SU1136-0AB20-1CA0	1	1 unit
			1	1	1	5	3SU1136-0AB20-1FA0	1	1 unit
		Yellow	1	1	0	5	3SU1136-0AB30-1BA0	1	1 unit
			1	1	1	5	3SU1136-0AB30-1FA0	1	1 unit
		Green	1	1	0	5	3SU1136-0AB40-1BA0	1	1 unit
			1	1	1	5	3SU1136-0AB40-1FA0	1	1 unit
		Blue	1	1	0	5	3SU1136-0AB50-1BA0	1	1 unit
			1	1	1	5	3SU1136-0AB50-1FA0	1	1 unit
		White	1	1	0	5	3SU1136-0AB60-1BA0	1	1 unit
			1	1	1	5	3SU1136-0AB60-1FA0	1	1 unit
		Clear	1	1	0	5	3SU1136-0AB70-1BA0	1	1 unit
			1	1	1	5	3SU1136-0AB70-1FA0	1	1 unit

Spring-type terminals

Pushbuttons with flat button, momentary contact



3SU1130-0AB10-3BA0

--	--	Black	1	1	0	5	3SU1130-0AB10-3BA0	1	1 unit
			1	1	1	5	3SU1130-0AB10-3FA0	1	1 unit
		Red	1	0	1	5	3SU1130-0AB20-3CA0	1	1 unit
			1	1	0	5	3SU1130-0AB40-3BA0	1	1 unit
		White	1	1	1	5	3SU1130-0AB60-3FA0	1	1 unit

Illuminated pushbuttons with flat button, momentary contact



3SU1132-0AB30-3BA0

24	24	Red	1	0	1	5	3SU1132-0AB20-3CA0	1	1 unit
			1	1	1	5	3SU1132-0AB20-3FA0	1	1 unit
		Yellow	1	1	0	5	3SU1132-0AB30-3BA0	1	1 unit
			1	1	1	5	3SU1132-0AB30-3FA0	1	1 unit
		Green	1	1	0	5	3SU1132-0AB40-3BA0	1	1 unit
			1	1	1	5	3SU1132-0AB40-3FA0	1	1 unit
		Blue	1	1	0	5	3SU1132-0AB50-3BA0	1	1 unit
			1	1	1	5	3SU1132-0AB50-3FA0	1	1 unit
		White	1	1	0	5	3SU1132-0AB60-3BA0	1	1 unit
			1	1	1	5	3SU1132-0AB60-3FA0	1	1 unit
		Clear	1	1	0	5	3SU1132-0AB70-3BA0	1	1 unit
			1	1	1	5	3SU1132-0AB70-3FA0	1	1 unit

3SU1 22 mm, Plastic with Metal Front Ring, Matte — Complete Units

Mushroom pushbuttons / EMERGENCY STOP mushroom pushbuttons

Selection and ordering data

Unlatching method	Number of			SD	Screw terminals	PU (UNIT, SET, M)	PS*
	Contact modules	NO contacts	NC contacts				
				d	Article No.	Price per PU	

Mushroom pushbuttons

With red mushroom, diameter 40 mm, latching

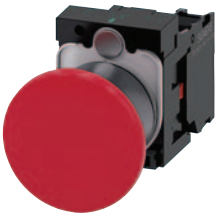

3SU1130-1BA20-1CA0

Pull to unlatch	1	0	1	5	3SU1130-1BA20-1CA0		1	1 unit
		1	1	5			3SU1130-1BA20-1FA0	

Selection and ordering data

Unlatching method	Number of			Marking	SD	Screw terminals	PU (UNIT, SET, M)	PS*
	Contact modules	NO con-tacts	NC con-tacts					
					d	Article No.	Price per PU	

EMERGENCY STOP mushroom pushbuttons, tamper-proof, in accordance with ISO 13850 and IEC 60947-5-5

With red mushroom, diameter 40 mm, with positive latching



3SU1100-1HA20-1CH0

Pull to unlatch	1	0	1	NOT-HALT	⊖	5	3SU1100-1HA20-1CH0		1	1 unit		
		1	1	EMERGENCY STOP	⊖	5			3SU1100-1HA20-1FG0		1	1 unit
		1	1	NOT-HALT	⊖	5			3SU1100-1HA20-1FH0		1	1 unit



3SU1100-1HB20-1CH0

Rotate to unlatch	1	0	1	None	⊖	5	3SU1100-1HB20-1CF0		1	1 unit			
		0	1	EMERGENCY STOP	⊖	5			3SU1100-1HB20-1CG0		1	1 unit	
		0	1	NOT-HALT	⊖	▶			5	3SU1100-1HB20-1CH0		1	1 unit
		0	2	EMERGENCY STOP	⊖	5			3SU1100-1HB20-1PG0		1	1 unit	
		0	2	EMERGENCY STOP	⊖	5			3SU1100-1HB20-1PA0		1	1 unit	
		1	1	EMERGENCY STOP Less backing plate	⊖	5			3SU1100-1HB20-1FG0		1	1 unit	
		1	1	EMERGENCY STOP NOT-HALT	⊖	▶			5	3SU1100-1HB20-1FH0		1	1 unit



3SU1100-1HB20-3CH0

						Spring-type terminals				
Rotate to unlatch	1	0	1	NOT-HALT	⊖	5	3SU1100-1HB20-3CH0		1	1 unit
		1	1	NOT-HALT	⊖	5			3SU1100-1HB20-3FH0	

⊖ Positive opening according to IEC 60947-5-1, Annex K. Can be used with 3SK11 safety relays or the 3RK3 Modular Safety System; see Section 13.

Certificate:



3SU1 22 mm, Plastic with Metal Front Ring, Matte — Complete Units

Coordinate switches, complete

Selection and ordering data

Operating principle	Color	Number of			SD	Screw terminals	PU (UNIT, SET, M)	PS*
		Contact modules	NO contacts	NC contacts				
						Article No.	Price per PU	

Selector switches

Short black actuator, 2 switch positions, can be illuminated



Latching, 90°	White	1	1	0	▶	3SU1130-2BF60-1BA0 3SU1130-2BF60-1MA0	1	1 unit
			1	1	▶		1	1 unit

Short black actuator, 3 switch positions, can be illuminated

Momentary contact, 2x45°	White	2	2	2	5	3SU1130-2BM60-1LA0 3SU1130-2BM60-1NA0	1	1 unit
			2	0	3		1	1 unit

Latching, 2x45°	White	2	2	2	▶	3SU1130-2BL60-1LA0 3SU1130-2BL60-1NA0	1	1 unit
			2	0	▶		1	1 unit

Short black actuator, 2 switch positions, can be illuminated



						Spring-type terminals		
Latching, 90°	White	1	1	0	5	3SU1130-2BF60-3BA0 3SU1130-2BF60-3MA0	1	1 unit
			1	1	5		1	1 unit

Short black actuator, 3 switch positions, can be illuminated

Momentary contact, 2x45°	White	2	2	0	5	3SU1130-2BM60-3NA0	1	1 unit

Latching, 2x45°	White	2	2	2	5	3SU1130-2BL60-3LA0 3SU1130-2BL60-3NA0	1	1 unit
			2	0	5		1	1 unit

3SU1 22 mm, Plastic with Metal Front Ring, Matte — Complete Units

Coordinate switches, complete

Selection and ordering data

Operating principle	Switch position for key removal	Number of			Number of keys	SD	Screw terminals	PU (UNIT, SET, M)	PS*
		Contact modules	NO contacts	NC contacts					
							Article No.	Price per PU	

Key-operated switches

With RONIS lock, SB30, 2 switch positions



3SU1130-4BF11-1BA0

Latching, 90°
(10:30/
1:30 o'clock)



	O+I	1	1	0	2	3	3SU1130-4BF11-1BA0	1	1 unit
		1	1	1	2	3	3SU1130-4BF11-1FA0	1	1 unit

With RONIS lock, SB30, 3 switch positions



3SU1130-4BL11-1NA0

Latching, 2x45°
(10:30/12/
1:30 o'clock)



	I+O+II	2	2	0	2	5	3SU1130-4BL11-1NA0	1	1 unit
--	--------	---	---	---	---	---	---------------------------	---	--------

With RONIS lock, SB30, 2 switch positions



3SU1130-4BF11-3BA0

Latching, 90°
(10:30/
1:30 o'clock)



							Spring-type terminals		
	O+I	1	1	0	2	5	3SU1130-4BF11-3BA0	1	1 unit

Selection and ordering data

Number of NO contacts (1 per direction)	Operating principle	Direction of actuation	SD	Screw terminals	PU (UNIT, SET, M)	PS*

Coordinate switches

Without mechanical interlock, 2 switch positions



3SU1130-7AE10-1QA0

2	Momentary contact	Horizontal	5	3SU1130-7AC10-1NA0	1	1 unit
		Vertical	5	3SU1130-7AD10-1NA0	1	1 unit
NEW	Latching	Horizontal	5	3SU1130-7AA10-1NA0	1	1 unit
		Vertical	5	3SU1130-7AB10-1NA0	1	1 unit

Without mechanical interlock, 4 switch positions

4	Momentary contact	Horizontal/Vertical	5	3SU1130-7AF10-1QA0	1	1 unit
		Latching	Horizontal/Vertical	5	3SU1130-7AE10-1QA0	1

With mechanical interlock, 2 switch positions

2	Momentary contact	Horizontal	5	3SU1130-7BC10-1NA0	1	1 unit
		Vertical	5	3SU1130-7BD10-1NA0	1	1 unit
NEW	Latching	Horizontal	5	3SU1130-7BA10-1NA0	1	1 unit
		Vertical	5	3SU1130-7BB10-1NA0	1	1 unit

With mechanical interlock, 4 switch positions

4	Momentary contact	Horizontal/Vertical	5	3SU1130-7BF10-1QA0	1	1 unit
		Latching	Horizontal/Vertical	5	3SU1130-7BE10-1QA0	1



3SU1130-7BE10-1QA0

3SU1 22 mm, Plastic with Metal Front Ring, Matte — Complete Units

Indicator Lights – Complete Units

Selection and ordering data

Operational voltage		Color		SD	Screw terminals	PU (UNIT, SET, M)	PS*
at AC, rated value	at DC, rated value	of actuating element	of light source				
V	V			d	Article No.	Price per PU	

Indicator lights

With smooth lens and integrated LED

	24	24	Red	Red	▶	3SU1102-6AA20-1AA0	1	1 unit
			Yellow	Yellow	▶	3SU1102-6AA30-1AA0	1	1 unit
			Green	Green	▶	3SU1102-6AA40-1AA0	1	1 unit
			Blue	Blue	▶	3SU1102-6AA50-1AA0	1	1 unit
			White	White	▶	3SU1102-6AA60-1AA0	1	1 unit
			Clear	White	▶	3SU1102-6AA70-1AA0	1	1 unit
	110	--	Amber	Amber	5	3SU1103-6AA00-1AA0	1	1 unit
			Red	Red	▶	3SU1103-6AA20-1AA0	1	1 unit
			Yellow	Yellow	▶	3SU1103-6AA30-1AA0	1	1 unit
			Green	Green	▶	3SU1103-6AA40-1AA0	1	1 unit
			Blue	Blue	3	3SU1103-6AA50-1AA0	1	1 unit
			White	White	▶	3SU1103-6AA60-1AA0	1	1 unit
			Clear	White	3	3SU1103-6AA70-1AA0	1	1 unit
	230	--	Amber	Amber	5	3SU1106-6AA00-1AA0	1	1 unit
			Red	Red	▶	3SU1106-6AA20-1AA0	1	1 unit
			Yellow	Yellow	▶	3SU1106-6AA30-1AA0	1	1 unit
			Green	Green	▶	3SU1106-6AA40-1AA0	1	1 unit
			Blue	Blue	3	3SU1106-6AA50-1AA0	1	1 unit
			White	White	▶	3SU1106-6AA60-1AA0	1	1 unit
			Clear	White	3	3SU1106-6AA70-1AA0	1	1 unit
	24	24	Red	Red	3	3SU1102-6AA20-3AA0	1	1 unit
			Yellow	Yellow	5	3SU1102-6AA30-3AA0	1	1 unit
			Green	Green	3	3SU1102-6AA40-3AA0	1	1 unit
			Blue	Blue	5	3SU1102-6AA50-3AA0	1	1 unit
			White	White	3	3SU1102-6AA60-3AA0	1	1 unit
			Clear	White	5	3SU1102-6AA70-3AA0	1	1 unit
	110	--	Red	Red	5	3SU1103-6AA20-3AA0	1	1 unit
			Yellow	Yellow	5	3SU1103-6AA30-3AA0	1	1 unit
			Green	Green	5	3SU1103-6AA40-3AA0	1	1 unit
			Blue	Blue	5	3SU1103-6AA50-3AA0	1	1 unit
			White	White	5	3SU1103-6AA60-3AA0	1	1 unit
	230	--	Red	Red	5	3SU1106-6AA20-3AA0	1	1 unit
			Yellow	Yellow	5	3SU1106-6AA30-3AA0	1	1 unit

3SU1 22 mm, Plastic with Metal Front Ring, Matte — Compact Units

Sensor switches / potentiometers

Selection and ordering data

Operational voltage at AC, rated value	Operational voltage at DC, rated value	Color of actuating element	Color of light source	SD	Screw terminals		PU (UNIT, SET, M)	PS*	
					Article No.	Price per PU			
V	V			d					
Indicator lights with "traffic light" LED NEW									
 3SU1201-6AG24-1AA0	6-24	6-24	Clear	Red/Yellow/ Green	▶	3SU1201-6AG24-1AA0		1	1 unit
	110	--	Clear	Red/Yellow/ Green	▶	3SU1201-6AC24-1AA0		1	1 unit
	230	--	Clear	Red/Yellow/ Green	▶	3SU1201-6AF24-1AA0		1	1 unit

Selection and ordering data

Operational voltage at AC, rated value	Operational voltage at DC, rated value	Volume level	SD	Screw terminals		PU (UNIT, SET, M)	PS*	
				Article No.	Price per PU			
V	V	dB	d					
Acoustic signaling devices NEW								
 3SU1200-6KB10-1AA0	24	24	90	5	▶	3SU1200-6KB10-1AA0	1	1 unit
	110	110	90	5	▶	3SU1200-6KC10-1AA0	1	1 unit
	230	230	90	5	▶	3SU1200-6KF10-1AA0	1	1 unit

Selection and ordering data

Operating principle	Number of NO contacts	Number of NC contacts	Color	SD	M12 connector, 4-pole		PU (UNIT, SET, M)	PS*
					Article No.	Price per PU		
				d				
Sensor switches								
 3SU1200-1SK10-2SA0	Whether integrated in the two-hand operation console or installed as a door opening contact, the capacitive sensor switch is suitable for many different applications in industrial environments.							
	The switch is actuated by simple contact with the hand or other part of the body (i.e. without the application of pressure). As a result, these switches are rugged, extremely durable and have the highest degree of protection IP66, IP67, IP69(IP69K).							
Without pressure	1	0	Black	▶	3SU1200-1SK10-2SA0		1	1 unit

Optional accessories:

- "Protection for sensor switches", see page 13/130.
- "Connectors for sensor switches, angled socket with screw terminal connection", see page 13/138.





3SU1 22 mm, Plastic with Metal Front Ring, Matte — Compact Units

Sensor switches / Pushbuttons with extended stroke

Selection and ordering data

Version of actuating element	Operating principle	Adjustable resistance	SD	Screw terminals	PU (UNIT, SET, M)	PS*
		kΩ	d	Article No.	Price per PU	
Potentiometers						
 <p>3SU1200-2PQ10-1AA0</p>	Rotary knob	Stepless	▶	1	3SU1200-2PQ10-1AA0	1 1 unit
				4.7	3SU1200-2PR10-1AA0	1 1 unit
				10	3SU1200-2PS10-1AA0	1 1 unit
				47	3SU1200-2PT10-1AA0	1 1 unit
				100	3SU1200-2PU10-1AA0	1 1 unit
				470	3SU1200-2PV10-1AA0	1 1 unit
				Labeling plates for potentiometers, see page 13/126		

Selection and ordering data

Version	Color	SD	Article No.	Price per PU	PU (UNIT, SET, M)	PS*	
		d					
Pushbuttons with extended stroke							
 <p>3SU1230-0EB40-0AA0</p>	For actuating relays, can only be combined with extension plunger, no contact module or LED module required						
	Pushbuttons with flat button	Red Green	5 5	3SU1230-0EB20-0AA0 3SU1230-0EB40-0AA0		1 1 unit 1 1 unit	
 <p>3SU1230-0FB10-0AA0</p>	Pushbuttons with raised button	Black	3	3SU1230-0FB10-0AA0		1 1 unit	
 <p>3SU1231-0EB20-0AA0</p>	Pushbuttons with flat transparent button for insertion of insert labels	Red Clear	3 3	3SU1231-0EB20-0AA0 3SU1231-0EB70-0AA0		1 1 unit 1 1 unit	
	Version	Material	Color	SD	Article No.	Price per PU	PU (UNIT, SET, M)
			d				
Accessories							
 <p>3SU1900-0KG10-0AA0</p>	Extension plungers	Plastic	Gray	▶	3SU1900-0KG10-0AA0		1 1 unit
	For compensation of the distance between the pushbutton and the unlatching button of an overload relay						

3SU1 22 mm, Plastic with Metal Front Ring, Matte — Actuating and Signaling Elements



Pushbuttons

Selection and ordering data

Version of actuating element Front ring version	Operating principle Unlatching method	Color, marking	SD	Article No.	Price per PU	PU (UNIT, SET, M)	PS*
Pushbuttons							
 3SU1030-0AB50-0AR0	Pushbuttons with flat button Standard	Momentary contact		Black ▶	▶	3SU1030-0AB10-0AA0	1 1 unit
				Black, "O" ▶	▶	3SU1030-0AB10-0AD0	1 1 unit
				Red ▶	▶	3SU1030-0AB20-0AA0	1 1 unit
				Red, "O" ▶	▶	3SU1030-0AB20-0AD0	1 1 unit
				Red, "AUTO" 5 ▶	▶	3SU1030-0AB20-0AQ0	1 1 unit
				Yellow ▶	▶	3SU1030-0AB30-0AA0	1 1 unit
				Green ▶	▶	3SU1030-0AB40-0AA0	1 1 unit
				Green, "I" ▶	▶	3SU1030-0AB40-0AC0	1 1 unit
				Blue ▶	▶	3SU1030-0AB50-0AA0	1 1 unit
				Blue, "R" 5 ▶	▶	3SU1030-0AB50-0AR0	1 1 unit
				White ▶	▶	3SU1030-0AB60-0AA0	1 1 unit
				White, "I" ▶	▶	3SU1030-0AB60-0AC0	1 1 unit
				Clear ▶	▶	3SU1030-0AB70-0AA0	1 1 unit
				Gray ▶	▶	3SU1030-0AB80-0AA0	1 1 unit
 3SU1030-0AA40-0AA0	Latching Push to unlatch			Black ▶	▶	3SU1030-0AA10-0AA0	1 1 unit
				Red ▶	▶	3SU1030-0AA20-0AA0	1 1 unit
				Yellow ▶	▶	3SU1030-0AA30-0AA0	1 1 unit
				Green ▶	▶	3SU1030-0AA40-0AA0	1 1 unit
				Blue ▶	▶	3SU1030-0AA50-0AA0	1 1 unit
				White ▶	▶	3SU1030-0AA60-0AA0	1 1 unit
 3SU1030-0BB20-0AA0	Pushbuttons with raised button Standard	Momentary contact		Black ▶	▶	3SU1030-0BB10-0AA0	1 1 unit
				Red ▶	▶	3SU1030-0BB20-0AA0	1 1 unit
				Yellow ▶	▶	3SU1030-0BB30-0AA0	1 1 unit
				Green ▶	▶	3SU1030-0BB40-0AA0	1 1 unit
				Blue ▶	▶	3SU1030-0BB50-0AA0	1 1 unit
				White ▶	▶	3SU1030-0BB60-0AA0	1 1 unit
 3SU1030-0CB30-0AA0	Pushbuttons with flat button Raised	Momentary contact		Black 5	▶	3SU1030-0CB10-0AA0	1 1 unit
				Red 5	▶	3SU1030-0CB20-0AA0	1 1 unit
				Yellow 5	▶	3SU1030-0CB30-0AA0	1 1 unit
				Green 5	▶	3SU1030-0CB40-0AA0	1 1 unit
				Blue 5	▶	3SU1030-0CB50-0AA0	1 1 unit
				White 5	▶	3SU1030-0CB60-0AA0	1 1 unit

3SU1 22 mm, Plastic with Metal Front Ring, Matte — Actuating and Signaling Elements

Pushbuttons

Version of actuating element	Operating principle	Color	SD	Article No.	Price per PU	PU (UNIT, SET, M)	PS*
Front ring version	Unlatching method		d				
Pushbuttons							
 3SU1031-0AB20-0AA0	Illuminated pushbuttons with flat button Standard	Momentary contact	Amber	5	3SU1031-0AB00-0AA0		1 1 unit
			Red	▶	3SU1031-0AB20-0AA0		1 1 unit
			Yellow	▶	3SU1031-0AB30-0AA0		1 1 unit
			Green	▶	3SU1031-0AB40-0AA0		1 1 unit
			Blue	▶	3SU1031-0AB50-0AA0		1 1 unit
			White	▶	3SU1031-0AB60-0AA0		1 1 unit
			Clear	▶	3SU1031-0AB70-0AA0		1 1 unit
 3SU1031-0AA50-0AA0	Illuminated pushbuttons with flat button Standard	Latching	Red	▶	3SU1031-0AA20-0AA0		1 1 unit
		Push to unlatch	Yellow	▶	3SU1031-0AA30-0AA0		1 1 unit
			Green	▶	3SU1031-0AA40-0AA0		1 1 unit
			Blue	▶	3SU1031-0AA50-0AA0		1 1 unit
			White	▶	3SU1031-0AA60-0AA0		1 1 unit
			Clear	▶	3SU1031-0AA70-0AA0		1 1 unit
 3SU1031-0BB40-0AA0	Illuminated pushbuttons with raised button Standard	Momentary contact	Red	▶	3SU1031-0BB20-0AA0		1 1 unit
			Yellow	▶	3SU1031-0BB30-0AA0		1 1 unit
			Green	▶	3SU1031-0BB40-0AA0		1 1 unit
			Blue	▶	3SU1031-0BB50-0AA0		1 1 unit
			Clear	3	3SU1031-0BB70-0AA0		1 1 unit

3SU1 22 mm, Plastic with Metal Front Ring, Matte — Actuating and Signaling Elements

Twin pushbuttons





Selection and ordering data

Version of actuating element	Operating principle	Color	Marking Symbol No.	SD	Article No.	Price per PU	PU (UNIT, SET, M)	PS*	
Twin pushbuttons									
 <p>3SU1030-3AB66-0AN0</p>	Twin pushbuttons flat, flat	Momentary contact	Green/Red	--	3		1	1 unit	
			"I"/"O"	▶	3SU1030-3AB42-0AA0				
			White/Black	--	3				3SU1030-3AB61-0AA0
			"I"/"O"	▶	3				3SU1030-3AB61-0AK0
			White/White	--	3				3SU1030-3AB66-0AA0
			Arrows, vert.	5	3SU1030-3AB66-0AN0				
Black/Black	--	3	3SU1030-3AB11-0AA0						
	○	5	3SU1030-3AB11-0AQ0						
	○		5264/5265 (IEC 60417)						
 <p>3SU1030-3BB42-0AK0</p>	Twin pushbuttons flat, raised	Momentary contact	Green/Red	--	3		1	1 unit	
			"I"/"O"	▶	3SU1030-3BB42-0AA0				
 <p>3SU1031-3AB42-0AN0</p>	Twin pushbuttons flat, flat, illuminated	Momentary contact	Green/Red	--	▶		1	1 unit	
			"I"/"O"	▶	3SU1031-3AB42-0AA0				
			Arrows, vert.	5	3SU1031-3AB42-0AN0				
			White/Black	--	▶				3SU1031-3AB61-0AA0
			"I"/"O"	▶	3SU1031-3AB61-0AK0				
			White/White	--	3				3SU1031-3AB66-0AA0
Arrows, vert.	5	3SU1031-3AB66-0AN0							
 <p>3SU1031-3BB61-0AA0</p>	Twin pushbuttons flat, raised, illuminated	Momentary contact	Green/Red	--	3		1	1 unit	
			"I"/"O"	▶	3SU1031-3BB42-0AA0				
			White/Black	--	3				3SU1031-3BB61-0AA0
	"I"/"O"	▶	3	3SU1031-3BB61-0AK0					

3SU1 22 mm, Plastic with Metal Front Ring, Matte — Actuating and Signaling Elements

Mushroom pushbuttons

Selection and ordering data

Version of actuating element	Operating principle Unlatching method	Color	SD	Article No.	Price per PU	PU (UNIT, SET, M)	PS*
Mushroom pushbuttons							
 3SU1030-1AD20-0AA0	Mushroom pushbuttons 30 mm diameter, 2 positions	Momentary contact	Black ▶	3SU1030-1AD10-0AA0		1	1 unit
			Red ▶	3SU1030-1AD20-0AA0		1	1 unit
			Yellow ▶	3SU1030-1AD30-0AA0		1	1 unit
			Green ▶	3SU1030-1AD40-0AA0		1	1 unit
	Latching Pull to unlatch	Black ▶	3SU1030-1AA10-0AA0		1	1 unit	
		Red ▶	3SU1030-1AA20-0AA0		1	1 unit	
 3SU1030-1BD40-0AA0	Mushroom pushbuttons 40 mm diameter, 2 positions	Momentary contact	Black 3	3SU1030-1BD10-0AA0		1	1 unit
			Red 3	3SU1030-1BD20-0AA0		1	1 unit
			Yellow 3	3SU1030-1BD30-0AA0		1	1 unit
			Green 3	3SU1030-1BD40-0AA0		1	1 unit
	Latching Pull to unlatch	Black ▶	3SU1030-1BA10-0AA0		1	1 unit	
		Red ▶	3SU1030-1BA20-0AA0		1	1 unit	
		Red, "O" 5	3SU1030-1BA20-0AD0		1	1 unit	
 3SU1031-1AD30-0AA0	Mushroom pushbuttons 30 mm diameter, 2 positions, illuminated	Momentary contact	Yellow 5	3SU1031-1AD30-0AA0		1	1 unit
			Green 3	3SU1031-1AD40-0AA0		1	1 unit
			White 3	3SU1031-1AD60-0AA0		1	1 unit
			Clear 5	3SU1031-1AD70-0AA0		1	1 unit
	Latching Pull to unlatch	Red 3	3SU1031-1AA20-0AA0		1	1 unit	
		Yellow 5	3SU1031-1AA30-0AA0		1	1 unit	
 3SU1031-1BD60-0AA0	Mushroom pushbuttons 40 mm diameter, 2 positions, illuminated	Momentary contact	Yellow 5	3SU1031-1BD30-0AA0		1	1 unit
			Green 5	3SU1031-1BD40-0AA0		1	1 unit
			White 3	3SU1031-1BD60-0AA0		1	1 unit
			Clear 5	3SU1031-1BD70-0AA0		1	1 unit
			Red 3	3SU1031-1BA20-0AA0		1	1 unit
	Latching Pull to unlatch	Red 3	3SU1031-1BA20-0AA0		1	1 unit	
		Yellow 3	3SU1031-1BA30-0AA0		1	1 unit	
 3SU1000-1HB50-0AA0	Mushroom pushbuttons 40 mm diameter, 2 positions	With positive latching, tamper-proof Rotate to unlatch	Black ▶	3SU1000-1HB10-0AA0		1	1 unit
			Blue 3	3SU1000-1HB50-0AA0		1	1 unit

3SU1 22 mm, Plastic with Metal Front Ring, Matte — Actuating and Signaling Elements

EMERGENCY STOP Mushroom pushbuttons

Selection and ordering data

Version of actuating element	Outer diameter of mushroom mm	Make of lock	Color	SD	Article No.	Price per PU	PU (UNIT, SET, M)	PS*
------------------------------	----------------------------------	--------------	-------	----	-------------	--------------	-------------------	-----

EMERGENCY STOP mushroom pushbuttons

With pull-to-unlatch mechanism



3SU1000-1HA20-0AA0

Tamper-proof, 2 positions	40	--	Red	▶	3SU1000-1HA20-0AA0		1	1 unit
---------------------------	----	----	-----	---	---------------------------	--	---	--------

With rotate-to-unlatch mechanism



3SU1000-1GB20-0AA0

Tamper-proof, 2 positions	33.8	--	Red	▶	3SU1000-1GB20-0AA0		1	1 unit
---------------------------	------	----	-----	---	---------------------------	--	---	--------



3SU1000-1HB20-0AA0

	40	--	Red	▶	3SU1000-1HB20-0AA0		1	1 unit
--	----	----	-----	---	---------------------------	--	---	--------



3SU1000-1JB20-0AA0

	60	--	Red	▶	3SU1000-1JB20-0AA0		1	1 unit
--	----	----	-----	---	---------------------------	--	---	--------

With rotate-to-unlatch mechanism, can be illuminated



3SU1001-1HB20-0AA0

Tamper-proof, 2 positions	33.8	--	Red	▶	3SU1001-1GB20-0AA0		1	1 unit
	40	--	Red	▶	3SU1001-1HB20-0AA0		1	1 unit
	60	--	Red	▶	3SU1001-1JB20-0AA0		1	1 unit





3SU1 22 mm, Plastic with Metal Front Ring, Matte — Actuating and Signaling Elements

EMERGENCY STOP mushroom pushbuttons / toggle switches

Version of actuating element	Outer diameter of mushroom mm	Make of lock	Color	Number of keys	SD d	Article No.	Price per PU	PU (UNIT, SET, M)	PS*
------------------------------	----------------------------------	--------------	-------	----------------	---------	-------------	--------------	-------------------	-----

EMERGENCY STOP mushroom pushbuttons

With key-operated release

 3SU1000-1HF20-0AA0	Tamper-proof, 2 positions	40	RONIS SB30	Red	2	▶	3SU1000-1HF20-0AA0 3SU1000-1HG20-0AA0	1	1 unit
			RONIS 455	Red	2	3		1	1 unit
 3SU1000-1HK20-0AA0			BKS S1	Red	2	▶	3SU1000-1HK20-0AA0	1	1 unit
			BKS E7	Red	0	3	3SU1000-1HM20-0AA0	1	1 unit
			BKS E9	Red	0	3	3SU1000-1HN20-0AA0	1	1 unit
 3SU1000-1HQ20-0AA0			O.M.R. 73037	Red	2	▶	3SU1000-1HQ20-0AA0	1	1 unit
 3SU1000-1HR20-0AA0			CES SSG10	Red	2	▶	3SU1000-1HR20-0AA0	1	1 unit
			CES SSP9	Red	2	▶	3SU1000-1HS20-0AA0	1	1 unit
			CES SMS1	Red	2	3	3SU1000-1HT20-0AA0	1	1 unit

Selection and ordering data

Number of switching positions	Number of command points	Color of actuating element	Operating principle of the actuating element	SD d	Article No.	Price per PU	PU (UNIT, SET, M)	PS*
-------------------------------	--------------------------	----------------------------	--	---------	-------------	--------------	-------------------	-----

Toggle switches

 3SU1030-3EA10-0AA0	2	1	Black	Latching	3	▶	3SU1030-3EA10-0AA0	1	1 unit
				Momentary contact, reset from above	5	▶	3SU1030-3EC10-0AA0	1	1 unit

3SU1 22 mm, Plastic with Metal Front Ring, Matte — Actuating and Signaling Elements

Selector switches

Selection and ordering data

Version of actuating element	Operating principle	Color	SD	Article No.	Price per PU	PU (UNIT, SET, M)	PS*
Selector switches							
2 switch positions, can be illuminated							
 3SU1032-2BC40-0AA0	Selector, short black actuator Momentary contact, 45° (10:30/12 o'clock), reset from center to left 	Black	3	3SU1032-2BC10-0AA0		1	1 unit
		Red	▶	3SU1032-2BC20-0AA0		1	1 unit
		Yellow	▶	3SU1032-2BC30-0AA0		1	1 unit
		Green	▶	3SU1032-2BC40-0AA0		1	1 unit
		Blue	▶	3SU1032-2BC50-0AA0		1	1 unit
		White	▶	3SU1032-2BC60-0AA0		1	1 unit
 3SU1032-2BF30-0AA0	Latching, 90° (10:30/1:30 o'clock) 	Black	▶	3SU1032-2BF10-0AA0		1	1 unit
		Red	▶	3SU1032-2BF20-0AA0		1	1 unit
		Yellow	▶	3SU1032-2BF30-0AA0		1	1 unit
		Green	▶	3SU1032-2BF40-0AA0		1	1 unit
		Blue	▶	3SU1032-2BF50-0AA0		1	1 unit
		White	▶	3SU1032-2BF60-0AA0		1	1 unit
 3SU1032-2CF60-0AA0	Selector, long black actuator Latching, 90° (10:30/1:30 o'clock) 	Black	3	3SU1032-2CF10-0AA0		1	1 unit
		Red	3	3SU1032-2CF20-0AA0		1	1 unit
		White	3	3SU1032-2CF60-0AA0		1	1 unit
 3SU1032-2AF20-0AA0	Rotary knob Latching, 90° (10:30/1:30 o'clock) 	Red	3	3SU1032-2AF20-0AA0		1	1 unit
		White	▶	3SU1032-2AF60-0AA0		1	1 unit

3SU1 22 mm, Plastic with Metal Front Ring, Matte — Actuating and Signaling Elements

Selector switches

Version of actuating element	Operating principle	Color	SD	Article No.	Price per PU	PU (UNIT, SET, M)	PS*
------------------------------	---------------------	-------	----	-------------	--------------	-------------------	-----

Selector switches

3 switch positions, can be illuminated



3SU1032-2BM60-0AA0

Selector, short black actuator

Momentary contact, 2x45° (10:30/12/1:30 o'clock), reset from left + right



- ▶ Black 3SU1032-2BM10-0AA0
- ▶ Red 3SU1032-2BM20-0AA0
- ▶ Yellow 3SU1032-2BM30-0AA0
- ▶ Green 3SU1032-2BM40-0AA0
- ▶ Blue 3SU1032-2BM50-0AA0
- ▶ White 3SU1032-2BM60-0AA0

- 1 1 unit
- 1 1 unit
- 1 1 unit
- 1 1 unit
- 1 1 unit
- 1 1 unit



3SU1032-2BL20-0AA0

Latching, 2x45° (10:30/12/1:30 o'clock)



- ▶ Black 3SU1032-2BL10-0AA0
- ▶ Red 3SU1032-2BL20-0AA0
- ▶ Yellow 3SU1032-2BL30-0AA0
- ▶ Green 3SU1032-2BL40-0AA0
- ▶ Blue 3SU1032-2BL50-0AA0
- ▶ White 3SU1032-2BL60-0AA0

- 1 1 unit
- 1 1 unit
- 1 1 unit
- 1 1 unit
- 1 1 unit
- 1 1 unit



3SU1032-2BP40-0AA0

Momentary contact/latching, 2x45° (10:30/12/1:30 o'clock), reset from left, latching to the right



- ▶ Black 3SU1032-2BP10-0AA0
- ▶ Red 5 3SU1032-2BP20-0AA0
- ▶ Yellow 1 3SU1032-2BP30-0AA0
- ▶ Green 1 3SU1032-2BP40-0AA0
- ▶ Blue 5 3SU1032-2BP50-0AA0
- ▶ White 1 3SU1032-2BP60-0AA0

- 1 1 unit
- 1 1 unit
- 1 1 unit
- 1 1 unit
- 1 1 unit
- 1 1 unit



3SU1032-2BN30-0AA0

Latching/momentary contact, 2x45° (10:30/12/1:30 o'clock), reset from right, latching to the left



- ▶ Black 3 3SU1032-2BN10-0AA0
- ▶ Red 1 3SU1032-2BN20-0AA0
- ▶ Yellow 1 3SU1032-2BN30-0AA0
- ▶ Green 1 3SU1032-2BN40-0AA0
- ▶ Blue 1 3SU1032-2BN50-0AA0
- ▶ White 1 3SU1032-2BN60-0AA0

- 1 1 unit
- 1 1 unit
- 1 1 unit
- 1 1 unit
- 1 1 unit
- 1 1 unit



3SU1030-2AS60-0AA0

4 switch positions

Rotary knob Latching, 4x90° (3/6/9/12 o'clock)



- ▶ White 3 3SU1030-2AS60-0AA0

- 1 1 unit

3SU1 22 mm, Plastic with Metal Front Ring, Matte — Actuating and Signaling Elements

Key-operated switches

Selection and ordering data

Operating principle	Make of lock	Switch position for key removal	Number of keys	SD	Article No.	Price per PU	PU (UNIT, SET, M)	PS*
---------------------	--------------	---------------------------------	----------------	----	-------------	--------------	-------------------	-----

Key-operated switches

2 switch positions



Momentary contact, 45° (10:30/12 o'clock), reset from center to left



RONIS, SB30	O	2	▶	3SU1030-4BC01-0AA0	1	1 unit
RONIS, 455	O	2	5	3SU1030-4CC01-0AA0	1	1 unit
O.M.R. 73037, red	O	2	3	3SU1030-4FC01-0AA0	1	1 unit
O.M.R. 73038, light blue	O	2	5	3SU1030-4GC01-0AA0	1	1 unit
O.M.R. 73034, black	O	2	5	3SU1030-4HC01-0AA0	1	1 unit
O.M.R. 73033, yellow	O	2	3	3SU1030-4JC01-0AA0	1	1 unit
CES, SSG10	O	2	▶	3SU1030-5BC01-0AA0	1	1 unit
CES, LSG1	O	2	3	3SU1030-5HC01-0AA0	1	1 unit
BKS, S1	O	2	▶	3SU1030-5PC01-0AA0	1	1 unit
IKON, 360012K1	O	2	3	3SU1030-5XC01-0AA0	1	1 unit



Latching, 90° (10:30/1:30 o'clock)



RONIS, SB30	O	2	▶	3SU1030-4BF01-0AA0	1	1 unit
	O+I	2	▶	3SU1030-4BF11-0AA0	1	1 unit
	I	2	3	3SU1030-4BF21-0AA0	1	1 unit
RONIS, 455	O	2	3	3SU1030-4CF01-0AA0	1	1 unit
	O+I	2	5	3SU1030-4CF11-0AA0	1	1 unit



O.M.R. 73037, red	O	2	3	3SU1030-4FF01-0AA0	1	1 unit
	O+I	2	3	3SU1030-4FF11-0AA0	1	1 unit
O.M.R. 73038, light blue	O	2	3	3SU1030-4GF01-0AA0	1	1 unit
	O+I	2	3	3SU1030-4GF11-0AA0	1	1 unit
O.M.R. 73034, black	O	2	3	3SU1030-4HF01-0AA0	1	1 unit
	O+I	2	3	3SU1030-4HF11-0AA0	1	1 unit
	I	2	5	3SU1030-4HF21-0AA0	1	1 unit
O.M.R. 73033, yellow	O	2	3	3SU1030-4JF01-0AA0	1	1 unit
	O+I	2	5	3SU1030-4JF11-0AA0	1	1 unit



CES, SSG10	O	2	▶	3SU1030-5BF01-0AA0	1	1 unit
	O+I	2	▶	3SU1030-5BF11-0AA0	1	1 unit
	I	2	3	3SU1030-5BF21-0AA0	1	1 unit
CES, LSG1	O	2	3	3SU1030-5HF01-0AA0	1	1 unit
	O+I	2	3	3SU1030-5HF11-0AA0	1	1 unit



BKS, S1	O	2	3	3SU1030-5PF01-0AA0	1	1 unit
	O+I	2	3	3SU1030-5PF11-0AA0	1	1 unit
	I	2	5	3SU1030-5PF21-0AA0	1	1 unit
BKS, E1	O	0	3	3SU1030-5QF01-0AA0	1	1 unit
	O+I	0	5	3SU1030-5QF11-0AA0	1	1 unit
BKS, E2	O	0	▶	3SU1030-5RF01-0AA0	1	1 unit
	O+I	0	3	3SU1030-5RF11-0AA0	1	1 unit
BKS, E7	O	0	▶	3SU1030-5SF01-0AA0	1	1 unit
	O+I	0	▶	3SU1030-5SF11-0AA0	1	1 unit
BKS, E9	O	0	3	3SU1030-5TF01-0AA0	1	1 unit
	O+I	0	3	3SU1030-5TF11-0AA0	1	1 unit
IKON, 360012K1	O	2	▶	3SU1030-5XF01-0AA0	1	1 unit
	O+I	2	3	3SU1030-5XF11-0AA0	1	1 unit

3SU1 22 mm, Plastic with Metal Front Ring, Matte — Actuating and Signaling Elements

Key-operated switches

Operating principle	Make of lock	Switch position for key removal	Number of keys	SD	Article No.	Price per PU	PU (UNIT, SET, M)	PS*
---------------------	--------------	---------------------------------	----------------	----	-------------	--------------	-------------------	-----

Key-operated switches

3 switch positions



Momentary contact, 2x45° (10:30/12/1:30 o'clock), reset from left + right



3SU1030-4BM01-0AA0

Latching, 2x45° (10:30/12/1:30 o'clock)



3SU1030-4JL11-0AA0



3SU1030-5BL41-0AA0



3SU1030-5PL01-0AA0

RONIS, SB30	O	2	3		3SU1030-4BM01-0AA0		1	1 unit
O.M.R. 73037, red	O	2	5		3SU1030-4FM01-0AA0		1	1 unit
O.M.R. 73034, black	O	2	5		3SU1030-4HM01-0AA0		1	1 unit
CES, SSG10	O	2	▶		3SU1030-5BM01-0AA0		1	1 unit
BKS, S1	O	2	3		3SU1030-5PM01-0AA0		1	1 unit
IKON, 360012K1	O	2	5		3SU1030-5XM01-0AA0		1	1 unit
RONIS, SB30	O	2	3		3SU1030-4BL01-0AA0		1	1 unit
	I+O+II	2	▶		3SU1030-4BL11-0AA0		1	1 unit
	I	2	5		3SU1030-4BL21-0AA0		1	1 unit
	II	2	3		3SU1030-4BL31-0AA0		1	1 unit
	I+II	2	5		3SU1030-4BL41-0AA0		1	1 unit
	O+I	2	3		3SU1030-4BL51-0AA0		1	1 unit
RONIS, 455	O	2	5		3SU1030-4CL01-0AA0		1	1 unit
	I+O+II	2	5		3SU1030-4CL11-0AA0		1	1 unit
O.M.R. 73037, red	O	2	5		3SU1030-4FL01-0AA0		1	1 unit
	O+I	2	5		3SU1030-4FL51-0AA0		1	1 unit
O.M.R. 73038, light blue	O	2	5		3SU1030-4GL01-0AA0		1	1 unit
	I+O+II	2	3		3SU1030-4GL11-0AA0		1	1 unit
O.M.R. 73034, black	O	2	5		3SU1030-4HL01-0AA0		1	1 unit
	I+O+II	2	3		3SU1030-4HL11-0AA0		1	1 unit
O.M.R. 73033, yellow	I+O+II	2	5		3SU1030-4JL11-0AA0		1	1 unit
CES, SSG10	O	2	3		3SU1030-5BL01-0AA0		1	1 unit
	I+O+II	2	▶		3SU1030-5BL11-0AA0		1	1 unit
	I	2	3		3SU1030-5BL21-0AA0		1	1 unit
	II	2	3		3SU1030-5BL31-0AA0		1	1 unit
	I+II	2	3		3SU1030-5BL41-0AA0		1	1 unit
	O+I	2	5		3SU1030-5BL51-0AA0		1	1 unit
BKS, S1	O	2	5		3SU1030-5PL01-0AA0		1	1 unit
	I+O+II	2	3		3SU1030-5PL11-0AA0		1	1 unit
	I	2	3		3SU1030-5PL21-0AA0		1	1 unit
	II	2	5		3SU1030-5PL31-0AA0		1	1 unit
	I+II	2	5		3SU1030-5PL41-0AA0		1	1 unit
BKS, E2	I+O+II	0	5		3SU1030-5RL11-0AA0		1	1 unit
BKS, E9	I+O+II	0	5		3SU1030-5TL11-0AA0		1	1 unit
IKON, 360012K1	O	2	5		3SU1030-5XL01-0AA0		1	1 unit
	I+O+II	2	5		3SU1030-5XL11-0AA0		1	1 unit

3SU1 22 mm, Plastic with Metal Front Ring, Matte — Actuating and Signaling Elements

Key-operated switches /

Operating principle	Make of lock	Switch position for key removal	Number of keys	SD	Article No.	Price per PU	PU (UNIT, SET, M)	PS*
---------------------	--------------	---------------------------------	----------------	----	-------------	--------------	-------------------	-----

Key-operated switches

3 switch positions



3SU1030-4BP01-0AA0



Momentary contact/latching, 2x45° (10:30/12/1:30 o'clock), reset from left, latching to the right	RONIS, SB30	O	2	5	3SU1030-4BP01-0AA0		1	1 unit
		II	2	5	3SU1030-4BP31-0AA0		1	1 unit
		O+II	2	5	3SU1030-4BP61-0AA0		1	1 unit
	CES, SSG10	O	2	3	3SU1030-5BP01-0AA0		1	1 unit
		II	2	5	3SU1030-5BP31-0AA0		1	1 unit
		O+II	2	3	3SU1030-5BP61-0AA0		1	1 unit

	BKS, S1	O	2	3	3SU1030-5PP01-0AA0		1	1 unit
--	---------	---	---	---	---------------------------	--	---	--------

Latching/momentary contact, 2x45° (10:30/12/1:30 o'clock), reset from right, latching to the left	RONIS, SB30	O	2	5	3SU1030-4BN01-0AA0		1	1 unit
		I	2	5	3SU1030-4BN21-0AA0		1	1 unit
		O+I	2	5	3SU1030-4BN51-0AA0		1	1 unit
	O.M.R. 73038, light blue	O	2	5	3SU1030-4GN01-0AA0		1	1 unit
		O.M.R. 73034, black	I	2	5	3SU1030-4HN21-0AA0		1



3SU1030-5BN01-0AA0

	CES, SSG10	O	2	3	3SU1030-5BN01-0AA0		1	1 unit
		I	2	3	3SU1030-5BN21-0AA0		1	1 unit
		O+I	2	3	3SU1030-5BN51-0AA0		1	1 unit

	BKS, S1	I	2	5	3SU1030-5PN21-0AA0		1	1 unit
--	---------	---	---	---	---------------------------	--	---	--------

		O+I	2	5	3SU1030-5PN51-0AA0		1	1 unit
--	--	-----	---	---	---------------------------	--	---	--------

	IKON, 360012K1	O+I	2	5	3SU1030-5XN51-0AA0		1	1 unit
--	----------------	-----	---	---	---------------------------	--	---	--------

Selection and ordering data

Operating angle	Operating principle	Switch position for key removal	Color	SD	Article No.	Price per PU	PU (UNIT, SET, M)	PS*
-----------------	---------------------	---------------------------------	-------	----	-------------	--------------	-------------------	-----

ID key-operated switches

4 switch positions



3SU1030-4WS10-0AA0

45°	Latching	Key removal possible in all 4 positions	Black	▶	3SU1030-4WS10-0AA0		1	1 unit
-----	----------	---	-------	---	---------------------------	--	---	--------



For available keys, [see page 10/152](#)

For electronic modules for ID key-operated switches, [see page 10/115](#)



3SU1 22 mm, Plastic with Metal Front Ring, Matte — Actuating and Signaling Elements

Indicator lights

Selection and ordering data

Product function Locking in zero position	Number of switching positions	Operating principle	Direction of actuation	SD	Article No.	Price per PU	PU (UNIT, SET, M)	PS*
Coordinate switches								
 3SU1030-7AA10-0AA0  3SU1030-7BA10-0AA0	No	2	Momentary contact	Horizontal Vertical	▶ ▶	3SU1030-7AC10-0AA0 3SU1030-7AD10-0AA0	1 1	1 unit 1 unit
			NEW	Latching	Horizontal Vertical	▶ ▶	3SU1030-7AA10-0AA0 3SU1030-7AB10-0AA0	1 1
		4	Momentary contact	Horizontal/ Ver- tical	▶	3SU1030-7AF10-0AA0	1	1 unit
			NEW	Latching	Horizontal/ Ver- tical	▶	3SU1030-7AE10-0AA0	1
	Yes	2	Momentary contact	Horizontal Vertical	▶ ▶	3SU1030-7BC10-0AA0 3SU1030-7BD10-0AA0	1 1	1 unit 1 unit
			NEW	Latching	Horizontal Vertical	▶ ▶	3SU1030-7BA10-0AA0 3SU1030-7BB10-0AA0	1 1
		4	Momentary contact	Horizontal/ Ver- tical	▶	3SU1030-7BF10-0AA0	1	1 unit
			NEW	Latching	Horizontal/ Ver- tical	▶	3SU1030-7BE10-0AA0	1





Selection and ordering data

Type of product	Color	SD	Article No.	Price per PU	PU (UNIT, SET, M)	PS*	
Indicator lights							
 3SU1001-6AA20-0AA0	With smooth lens		Amber	3	3SU1001-6AA00-0AA0	1	1 unit
		Red	▶	3SU1001-6AA20-0AA0	1	1 unit	
		Yellow	▶	3SU1001-6AA30-0AA0	1	1 unit	
		Green	▶	3SU1001-6AA40-0AA0	1	1 unit	
		Blue	▶	3SU1001-6AA50-0AA0	1	1 unit	
		White	▶	3SU1001-6AA60-0AA0	1	1 unit	
		Clear	▶	3SU1001-6AA70-0AA0	1	1 unit	
	Indicator lights in illuminated pushbutton design NEW						
 3SU1031-0AD50-0AA0	--	Red	3	3SU1031-0AD20-0AA0	1	1 unit	
		Yellow	5	3SU1031-0AD30-0AA0	1	1 unit	
		Green	3	3SU1031-0AD40-0AA0	1	1 unit	
		Blue	5	3SU1031-0AD50-0AA0	1	1 unit	
		Clear	3	3SU1031-0AD70-0AA0	1	1 unit	

3SU1 22 mm, Metal, Shiny — Complete Units

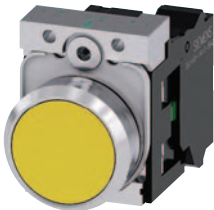









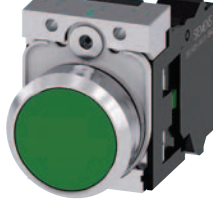



Pushbuttons

Selection and ordering data

Supply voltage for light source	Color	Number of			SD	Screw terminals	PU (UNIT, SET, M)	PS*			
		At AC	At DC	Contact modules					NO contacts	NC contacts	
V	V					Article No.	Price per PU				
Pushbuttons											
Pushbuttons with flat button, momentary contact											
	--	--	Black	1	1	0	▶	3SU1150-0AB10-1BA0	1	1 unit	
				0	1	3	▶	3SU1150-0AB10-1CA0	1	1 unit	
				1	1	▶	3SU1150-0AB10-1FA0	1	1 unit		
	Red	1	1	0	5	▶	3SU1150-0AB20-1BA0	1	1 unit		
		0	1	▶	3SU1150-0AB20-1CA0	1	1 unit				
		1	1	▶	3SU1150-0AB20-1FA0	1	1 unit				
	Yellow	1	1	0	3	▶	3SU1150-0AB30-1BA0	1	1 unit		
		1	1	5	▶	3SU1150-0AB30-1FA0	1	1 unit			
	Green	1	1	0	▶	3SU1150-0AB40-1BA0	1	1 unit			
		1	1	▶	3SU1150-0AB40-1FA0	1	1 unit				
	Blue	1	1	0	3	▶	3SU1150-0AB50-1BA0	1	1 unit		
		1	1	5	▶	3SU1150-0AB50-1FA0	1	1 unit			
	White	1	1	0	3	▶	3SU1150-0AB60-1BA0	1	1 unit		
		1	1	3	▶	3SU1150-0AB60-1FA0	1	1 unit			
Clear	1	1	0	5	▶	3SU1150-0AB70-1BA0	1	1 unit			
	1	1	5	▶	3SU1150-0AB70-1FA0	1	1 unit				
Pushbuttons with raised button, momentary contact											
	--	--	Black	1	1	0	5	▶	3SU1150-0BB10-1BA0	1	1 unit
				0	1	5	▶	3SU1150-0BB10-1CA0	1	1 unit	
				1	1	5	▶	3SU1150-0BB10-1FA0	1	1 unit	
	Red	1	0	1	3	▶	3SU1150-0BB20-1CA0	1	1 unit		
		1	1	5	▶	3SU1150-0BB20-1FA0	1	1 unit			
	Green	1	1	1	5	▶	3SU1150-0BB40-1FA0	1	1 unit		
		1	1	0	5	▶	3SU1150-0BB50-1BA0	1	1 unit		
	Blue	1	1	1	5	▶	3SU1150-0BB50-1FA0	1	1 unit		
Illuminated pushbuttons with flat button, momentary contact, with integrated LED											
	24	24	Amber	1	1	0	5	▶	3SU1152-0AB00-1BA0	1	1 unit
				1	1	5	▶	3SU1152-0AB00-1FA0	1	1 unit	
			Red	1	0	1	▶	3SU1152-0AB20-1CA0	1	1 unit	
				1	1	▶	3SU1152-0AB20-1FA0	1	1 unit		
			Yellow	1	1	0	▶	3SU1152-0AB30-1BA0	1	1 unit	
				1	1	3	▶	3SU1152-0AB30-1FA0	1	1 unit	
			Green	1	1	0	▶	3SU1152-0AB40-1BA0	1	1 unit	
	1	1		▶	3SU1152-0AB40-1FA0	1	1 unit				
	Blue	1	1	0	▶	3SU1152-0AB50-1BA0	1	1 unit			
		1	1	5	▶	3SU1152-0AB50-1FA0	1	1 unit			
	White	1	1	0	▶	3SU1152-0AB60-1BA0	1	1 unit			
		1	1	▶	3SU1152-0AB60-1FA0	1	1 unit				
	Clear	1	1	0	▶	3SU1152-0AB70-1BA0	1	1 unit			
		1	1	▶	3SU1152-0AB70-1FA0	1	1 unit				
	110	--	Amber	1	1	0	5	▶	3SU1153-0AB00-1BA0	1	1 unit
				1	1	5	▶	3SU1153-0AB00-1FA0	1	1 unit	
			Red	1	0	1	5	▶	3SU1153-0AB20-1CA0	1	1 unit
				1	1	5	▶	3SU1153-0AB20-1FA0	1	1 unit	
			Yellow	1	1	0	5	▶	3SU1153-0AB30-1BA0	1	1 unit
				1	1	5	▶	3SU1153-0AB30-1FA0	1	1 unit	
			Green	1	1	0	3	▶	3SU1153-0AB40-1BA0	1	1 unit
	1	1		5	▶	3SU1153-0AB40-1FA0	1	1 unit			
	Blue	1	1	0	5	▶	3SU1153-0AB50-1BA0	1	1 unit		
		1	1	5	▶	3SU1153-0AB50-1FA0	1	1 unit			
	White	1	1	0	5	▶	3SU1153-0AB60-1BA0	1	1 unit		
		1	1	5	▶	3SU1153-0AB60-1FA0	1	1 unit			
	Clear	1	1	0	5	▶	3SU1153-0AB70-1BA0	1	1 unit		
		1	1	5	▶	3SU1153-0AB70-1FA0	1	1 unit			
230	--	Amber	1	1	0	5	▶	3SU1156-0AB00-1BA0	1	1 unit	
			1	1	5	▶	3SU1156-0AB00-1FA0	1	1 unit		
		Red	1	0	1	5	▶	3SU1156-0AB20-1CA0	1	1 unit	
			1	1	5	▶	3SU1156-0AB20-1FA0	1	1 unit		
		Yellow	1	1	0	5	▶	3SU1156-0AB30-1BA0	1	1 unit	
			1	1	5	▶	3SU1156-0AB30-1FA0	1	1 unit		
		Green	1	1	0	3	▶	3SU1156-0AB40-1BA0	1	1 unit	
1	1		5	▶	3SU1156-0AB40-1FA0	1	1 unit				

3SU1 22 mm, Metal, Shiny — Complete Units

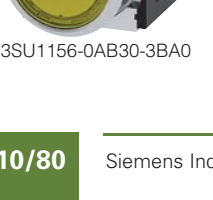
Pushbuttons

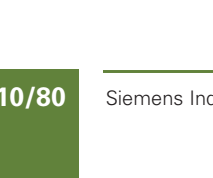
	Supply voltage for light source		Color	Number of Contact modules			SD	Screw terminals	PU (UNIT, SET, M)	PS*		
	At AC	At DC			NO contacts	NC contacts						
	V	V				d	Article No.	Price per PU				
Pushbuttons												
	230	--	Blue	1	1	0	5	3SU1156-0AB50-1BA0		1	1 unit	
					1	1	1	5	3SU1156-0AB50-1FA0		1	1 unit
			White	1	1	0	5	3SU1156-0AB60-1BA0		1	1 unit	
					1	1	1	5	3SU1156-0AB60-1FA0		1	1 unit
			Clear	1	1	0	5	3SU1156-0AB70-1BA0		1	1 unit	
					1	1	5	3SU1156-0AB70-1FA0		1	1 unit	
								Spring-type terminals				
Pushbuttons with flat button, momentary contact												
3SU1156-0AB50-1BA0	--	--	Black	1	1	0	▶ 5	3SU1150-0AB10-3BA0		1	1 unit	
					0	1	5	3SU1150-0AB10-3CA0		1	1 unit	
					1	1	5	3SU1150-0AB10-3FA0		1	1 unit	
			Red	1	1	0	5	3SU1150-0AB20-3CA0		1	1 unit	
					0	1	5	3SU1150-0AB20-3FA0		1	1 unit	
			Yellow	1	1	0	5	3SU1150-0AB30-3BA0		1	1 unit	
					1	1	5	3SU1150-0AB30-3FA0		1	1 unit	
			Green	1	1	0	5	3SU1150-0AB40-3BA0		1	1 unit	
					1	1	5	3SU1150-0AB40-3FA0		1	1 unit	
			Blue	1	1	0	5	3SU1150-0AB50-3BA0		1	1 unit	
					1	1	5	3SU1150-0AB50-3FA0		1	1 unit	
			White	1	1	0	5	3SU1150-0AB60-3BA0		1	1 unit	
					1	1	5	3SU1150-0AB60-3FA0		1	1 unit	
Pushbuttons with raised button, momentary contact												
	--	--	Red	1	0	1	5	3SU1150-0BB20-3CA0		1	1 unit	
Illuminated pushbuttons with flat button, momentary contact, with integrated LED												
3SU1152-0AB20-3CA0	24	24	Red	1	0	1	5	3SU1152-0AB20-3CA0		1	1 unit	
						1	5	3SU1152-0AB20-3FA0		1	1 unit	
			Yellow	1	1	0	5	3SU1152-0AB30-3BA0		1	1 unit	
						1	5	3SU1152-0AB30-3FA0		1	1 unit	
			Green	1	1	0	5	3SU1152-0AB40-3BA0		1	1 unit	
						1	3	3SU1152-0AB40-3FA0		1	1 unit	
			Blue	1	1	0	5	3SU1152-0AB50-3BA0		1	1 unit	
						1	5	3SU1152-0AB50-3FA0		1	1 unit	
			White	1	1	0	3	3SU1152-0AB60-3BA0		1	1 unit	
						1	5	3SU1152-0AB60-3FA0		1	1 unit	
			Clear	1	1	0	5	3SU1152-0AB70-3BA0		1	1 unit	
						1	5	3SU1152-0AB70-3FA0		1	1 unit	
3SU1153-0AB20-3CA0	110	--	Red	1	0	1	5	3SU1153-0AB20-3CA0		1	1 unit	
						1	5	3SU1153-0AB20-3FA0		1	1 unit	
			Yellow	1	1	0	5	3SU1153-0AB30-3BA0		1	1 unit	
						1	5	3SU1153-0AB30-3FA0		1	1 unit	
			Green	1	1	0	5	3SU1153-0AB40-3BA0		1	1 unit	
						1	5	3SU1153-0AB40-3FA0		1	1 unit	
			Blue	1	1	0	5	3SU1153-0AB50-3BA0		1	1 unit	
						1	5	3SU1153-0AB50-3FA0		1	1 unit	
			White	1	1	0	5	3SU1153-0AB60-3BA0		1	1 unit	
						1	5	3SU1153-0AB60-3FA0		1	1 unit	
			Clear	1	1	0	5	3SU1153-0AB70-3BA0		1	1 unit	
						1	5	3SU1153-0AB70-3FA0		1	1 unit	
3SU1156-0AB20-3CA0	230	--	Red	1	0	1	5	3SU1156-0AB20-3CA0		1	1 unit	
						1	5	3SU1156-0AB20-3FA0		1	1 unit	
			Yellow	1	1	0	5	3SU1156-0AB30-3BA0		1	1 unit	
						1	5	3SU1156-0AB30-3FA0		1	1 unit	
			Green	1	1	0	5	3SU1156-0AB40-3BA0		1	1 unit	
						1	5	3SU1156-0AB40-3FA0		1	1 unit	
			Blue	1	1	0	5	3SU1156-0AB50-3BA0		1	1 unit	
						1	5	3SU1156-0AB50-3FA0		1	1 unit	
			White	1	1	0	5	3SU1156-0AB60-3BA0		1	1 unit	
						1	5	3SU1156-0AB60-3FA0		1	1 unit	
			Clear	1	1	0	5	3SU1156-0AB70-3BA0		1	1 unit	
						1	5	3SU1156-0AB70-3FA0		1	1 unit	

3SU1 22 mm, Metal, Shiny — Complete Units

Mushroom pushbuttons / EMERGENCY STOP mushroom pushbuttons

Selection and ordering data

Unlatching method	Number of			SD	Screw terminals	PU (UNIT, SET, M)	PS*
	Contact modules	NO contacts	NC contacts				

Mushroom pushbuttons

With red mushroom, diameter 40 mm, latching

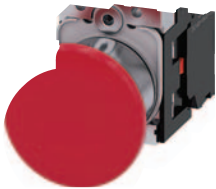

3SU1150-1BA20-1CA0

Unlatching method	Number of			SD	Screw terminals	PU (UNIT, SET, M)	PS*
	Contact modules	NO contacts	NC contacts				
Pull to unlatch	1	0	1	▶	3SU1150-1BA20-1CA0	1	1 unit
		1	1	3			
Pull to unlatch	1	0	1	5	3SU1150-1BA20-3CA0	1	1 unit
		1	1	5			

Unlatching method	Number of			Marking	SD	Screw terminals	PU (UNIT, SET, M)	PS*
	Contact modules	NO contacts	NC contacts					

EMERGENCY STOP mushroom pushbuttons, tamper-proof, in accordance with ISO 13850 and IEC 60947-5-5

With red mushroom, diameter 40 mm, with positive latching



3SU1150-1HB20-1CH0

Unlatching method	Number of			Marking	SD	Screw terminals	PU (UNIT, SET, M)	PS*
	Contact modules	NO contacts	NC contacts					
Pull to unlatch	1	0	1	EMERGENCY STOP	⊖	3SU1150-1HA20-1CG0	1	1 unit
		1	1	5				
Pull to unlatch	1	0	1	NOT-HALT	⊖	3SU1150-1HA20-1CH0	1	1 unit
		1	1	5				
Pull to unlatch	1	0	1	EMERGENCY STOP	⊖	3SU1150-1HA20-1FH0	1	1 unit
		1	1	5				
Rotate to unlatch	1	0	1	EMERGENCY STOP	⊖	3SU1150-1HB20-1CG0	1	1 unit
		1	1	3				
Rotate to unlatch	1	0	1	NOT-HALT	▶	3SU1150-1HB20-1CH0	1	1 unit
		1	1	▶				
Rotate to unlatch	1	0	1	EMERGENCY STOP	⊖	3SU1150-1HB20-1FG0	1	1 unit
		1	1	5				
Rotate to unlatch	1	0	1	NOT-HALT	▶	3SU1150-1HB20-1FH0	1	1 unit
		1	1	▶				



3SU1150-1HA20-3CH0

Unlatching method	Number of			Marking	SD	Spring-type terminals	PU (UNIT, SET, M)	PS*
	Contact modules	NO contacts	NC contacts					
Pull to unlatch	1	0	1	NOT-HALT	⊖	3SU1150-1HA20-3CH0	1	1 unit
		0	2	NOT-HALT	⊖			
		0	2	NOT-HALT	⊖			
Rotate to unlatch	1	0	1	NOT-HALT	⊖	3SU1150-1HB20-3CH0	1	1 unit
		0	2	NOT-HALT	⊖			
		0	2	NOT-HALT	⊖			

Illuminated EMERGENCY STOP with integrated LED light module, Rated 24-240V AC/DC

Red button, yellow backing plate, plastic with text:

Rotate to unlatch	2	0	2	EMERGENCY STOP	5	3SU1158-1HB20-1PT0	1	1 unit
-------------------	---	---	---	----------------	---	--------------------	---	--------

Red button, yellow backing plate, self-adhesive label with text:

Rotate to unlatch	2	1	1	EMERGENCY STOP	5	A6X30120577	1	1 unit
-------------------	---	---	---	----------------	---	-------------	---	--------

Red button, yellow backing plate, self-adhesive label with text:

Rotate to unlatch	2	1	2	EMERGENCY STOP	5	A6X30120587	1	1 unit
-------------------	---	---	---	----------------	---	-------------	---	--------

Red button, installed-monitoring contact modules, yellow backing plate, self-adhesive label with text

Rotate to unlatch	2	0	2 MC	EMERGENCY STOP	5	A6X30120588	1	1 unit
-------------------	---	---	------	----------------	---	-------------	---	--------

⊖ Positive opening according to IEC 60947-5-1, Annex K.
Can be used with 3SK11 safety relays or the 3RK3 Modular Safety System;
see Section 13.

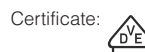

3SU1 22 mm, Metal, Shiny — Complete Units

Selector switches / key-operated switches

Selection and ordering data

Operating principle	Color	Number of			SD	Screw terminals	PU (UNIT, SET, M)	PS*
		Contact modules	NO contacts	NC contacts				
						Article No.	Price per PU	

Selector switches

Short black actuator, 2 switch positions

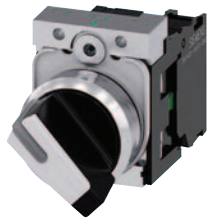

3SU1150-2BF60-1BA0

Latching, 90°	White	1	1	0	▶	3SU1150-2BF60-1BA0 3SU1150-2BF60-1FA0 3SU1150-2BF60-1MA0	1	1 unit
			1	1	3		1	1 unit
		2	1	1	▶		1	1 unit

Short black actuator, 3 switch positions (I - O - II)

Momentary contact, 2x45°, reset from left + right	White	2	2	2	▶	3SU1150-2BM60-1LA0 3SU1150-2BM60-1NA0	1	1 unit
			2	0	3		1	1 unit

Latching, 2x45°	White	2	2	2	▶	3SU1150-2BL60-1LA0 3SU1150-2BL60-1NA0	1	1 unit
			2	0	▶		1	1 unit

Spring-type terminals

Short black actuator, 2 switch positions



3SU1150-2BL60-3NA0

Latching, 90°	White	1	1	0	5	3SU1150-2BF60-3BA0 3SU1150-2BF60-3MA0	1	1 unit
		2	1	1	5		1	1 unit

Short black actuator, 3 switch positions

Momentary contact, 2x45°, reset from left + right	White	2	2	2	5	3SU1150-2BM60-3LA0 3SU1150-2BM60-3NA0	1	1 unit
			2	0	5		1	1 unit

Latching, 2x45°	White	2	2	2	5	3SU1150-2BL60-3LA0 3SU1150-2BL60-3NA0	1	1 unit
			2	0	5		1	1 unit

Selection and ordering data

Operating principle	Switch position for key removal	Number of			Number of keys	SD	Screw terminals	PU (UNIT, SET, M)	PS*
		Contact modules	NO contacts	NC contacts					
						Article No.	Price per PU		

Key-operated switches

With RONIS lock, SB30, 2 switch positions



3SU1150-4BF11-1BA0

Latching, 90° (10:30/1:30 o'clock)	All	1	1	0	2	3	3SU1150-4BF11-1BA0 3SU1150-4BF11-1FA0	1	1 unit
	All		1	1	2	3		1	1 unit

Spring-type terminals

All	All	1	1	0	2	5	3SU1150-4BF11-3BA0 3SU1150-4BF11-3FA0 3SU1150-4BF01-3PA0	1	1 unit
All	All		1	1	2	5		1	1 unit
O	O	2	0	2	2	5		1	1 unit

3SU1 22 mm, Metal, Shiny — Complete Units

Coordinate switches

Selection and ordering data

Number of NO contacts (1 per direction)	Operating principle	Direction of actuation	SD	Screw terminals		PU (UNIT, SET, M)	PS*
				Article No.	Price per PU		

Coordinate switches

Without mechanical interlock, 2 switch positions

2		Momentary contact	Horizontal	5	3SU1150-7AC88-1NA0	1	1 unit
			Vertical	5	3SU1150-7AD88-1NA0	1	1 unit
	NEW	Latching	Horizontal	5	3SU1150-7AA88-1NA0	1	1 unit
			Vertical	5	3SU1150-7AB88-1NA0	1	1 unit

Without mechanical interlock, 4 switch positions

4		Momentary contact	Horizontal/Vertical	3	3SU1150-7AF88-1QA0	1	1 unit
		NEW	Latching	Horizontal/Vertical	5	3SU1150-7AE88-1QA0	1

With mechanical interlock, 2 switch positions

2		Momentary contact	Horizontal	5	3SU1150-7BC88-1NA0	1	1 unit
			Vertical	5	3SU1150-7BD88-1NA0	1	1 unit
	NEW	Latching	Horizontal	5	3SU1150-7BA88-1NA0	1	1 unit
			Vertical	5	3SU1150-7BB88-1NA0	1	1 unit

With mechanical interlock, 4 switch positions

4		Momentary contact	Horizontal/Vertical	5	3SU1150-7BF88-1QA0	1	1 unit
		NEW	Latching	Horizontal/Vertical	5	3SU1150-7BE88-1QA0	1



3SU1150-7AF88-1QA0

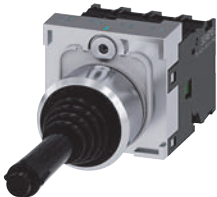

3SU1150-7BF88-1QA0

3SU1 22 mm, Metal, Shiny — Complete Units

Indicator lights

Selection and ordering data

Operational voltage		Color		SD	Screw terminals	PU (UNIT, SET, M)	PS*
at AC, rated value	at DC, rated value	of actuating element	of light source				
V	V			d	Article No.	Price per PU	

Indicator lights

With smooth lens and integrated LED

 <p>3SU1152-6AA50-1AA0</p>	24	24	Amber	Amber	5	3SU1152-6AA00-1AA0	1	1 unit			
			Red	Red	▶	3SU1152-6AA20-1AA0	1	1 unit			
			Yellow	Yellow	▶	3SU1152-6AA30-1AA0	1	1 unit			
			Green	Green	▶	3SU1152-6AA40-1AA0	1	1 unit			
			Blue	Blue	3	3SU1152-6AA50-1AA0	1	1 unit			
			White	White	▶	3SU1152-6AA60-1AA0	1	1 unit			
			Clear	White	5	3SU1152-6AA70-1AA0	1	1 unit			
			 <p>3SU1156-6AA60-1AA0</p>	110	--	Amber	Amber	5	3SU1153-6AA00-1AA0	1	1 unit
Red	Red	▶				3SU1153-6AA20-1AA0	1	1 unit			
Yellow	Yellow	3				3SU1153-6AA30-1AA0	1	1 unit			
Green	Green	▶				3SU1153-6AA40-1AA0	1	1 unit			
Blue	Blue	5				3SU1153-6AA50-1AA0	1	1 unit			
White	White	3				3SU1153-6AA60-1AA0	1	1 unit			
Clear	White	5				3SU1153-6AA70-1AA0	1	1 unit			
 <p>3SU1156-6AA60-1AA0</p>	230	--				Red	Red	▶	3SU1156-6AA20-1AA0	1	1 unit
			Yellow	Yellow	3	3SU1156-6AA30-1AA0	1	1 unit			
			Green	Green	▶	3SU1156-6AA40-1AA0	1	1 unit			
			Blue	Blue	5	3SU1156-6AA50-1AA0	1	1 unit			
			White	White	3	3SU1156-6AA60-1AA0	1	1 unit			
			Clear	White	5	3SU1156-6AA70-1AA0	1	1 unit			
									Spring-type terminals		
			 <p>3SU1152-6AA40-3AA0</p>	24	24	Red	Red	3	3SU1152-6AA20-3AA0	1	1 unit
						Yellow	Yellow	5	3SU1152-6AA30-3AA0	1	1 unit
						Green	Green	3	3SU1152-6AA40-3AA0	1	1 unit
Blue	Blue	3				3SU1152-6AA50-3AA0	1	1 unit			
White	White	5				3SU1152-6AA60-3AA0	1	1 unit			
Clear	White	5				3SU1152-6AA70-3AA0	1	1 unit			
 <p>3SU1156-6AA20-3AA0</p>	110	--	Red	Red	5	3SU1153-6AA20-3AA0	1	1 unit			
			Yellow	Yellow	5	3SU1153-6AA30-3AA0	1	1 unit			
			Green	Green	5	3SU1153-6AA40-3AA0	1	1 unit			
			Blue	Blue	5	3SU1153-6AA50-3AA0	1	1 unit			
			White	White	5	3SU1153-6AA60-3AA0	1	1 unit			
			Clear	White	5	3SU1153-6AA70-3AA0	1	1 unit			
			 <p>3SU1156-6AA20-3AA0</p>	230	--	Red	Red	5	3SU1156-6AA20-3AA0	1	1 unit
						Yellow	Yellow	5	3SU1156-6AA30-3AA0	1	1 unit
						Green	Green	5	3SU1156-6AA40-3AA0	1	1 unit
						Blue	Blue	5	3SU1156-6AA50-3AA0	1	1 unit
			White	White	5	3SU1156-6AA60-3AA0	1	1 unit			
			Clear	White	5	3SU1156-6AA70-3AA0	1	1 unit			

3SU1 22 mm, Metal, Shiny — Compact Units

Potentiometers

Selection and ordering data

Operational voltage		Color of actuating element	Color of light source	SD	Screw terminals	PU (UNIT, SET, M)	PS*
at AC, rated value	at DC, rated value						
V	V			d	Article No.	Price per PU	
Indicator lights with "traffic light" LED <i>NEW</i>							
6 ... 24	6 ... 24	Clear	Red/Yellow/Green	▶	3SU1251-6AG24-1AA0	1	1 unit
110	--	Clear	Red/Yellow/Green	▶	3SU1251-6AC24-1AA0	1	1 unit
230	--	Clear	Red/Yellow/Green	▶	3SU1251-6AF24-1AA0	1	1 unit



3SU1251-6AG24-1AA0

Selection and ordering data

Operational voltage		Volume level	SD	Screw terminals	PU (UNIT, SET, M)	PS*
at AC, rated value	at DC, rated value					
V	V	dB	d	Article No.	Price per PU	
Acoustic signaling devices <i>NEW</i>						
24	24	90	5	▶	3SU1250-6KB10-1AA0	1 1 unit
110	110	90	5	▶	3SU1250-6KC10-1AA0	1 1 unit
230	230	90	5	▶	3SU1250-6KF10-1AA0	1 1 unit



3SU1250-6KB10-1AA0

Selection and ordering data

Version of actuating element	Operating principle	Adjustable resistance	SD	Screw terminals	PU (UNIT, SET, M)	PS*
Potentiometers						
Rotary knob	Stepless	1	▶	3SU1250-2PQ10-1AA0	1	1 unit
		4.7	▶	3SU1250-2PR10-1AA0	1	1 unit
		10	▶	3SU1250-2PS10-1AA0	1	1 unit
		47	▶	3SU1250-2PT10-1AA0	1	1 unit
		100	▶	3SU1250-2PU10-1AA0	1	1 unit
		470	▶	3SU1250-2PV10-1AA0	1	1 unit



3SU1250-2PQ10-1AA0

Labeling plates for potentiometers, [see page 10/144](#).

3SU1 22 mm, Metal, Shiny — Compact Units

Pushbuttons with extended stroke

Selection and ordering data

Version	Color	SD	Article No.	Price per PU	PU (UNIT, SET, M)	PS*
---------	-------	----	-------------	--------------	-------------------	-----

Pushbuttons with extended stroke

For actuating relays, can only be combined with extension plunger, no contact module or LED module required



3SU1250-0EB40-0AA0

Pushbuttons with flat button

Red	5	3SU1250-0EB20-0AA0	1	1 unit
Green	5	3SU1250-0EB40-0AA0	1	1 unit
Blue	7	3SU1250-0EB50-0AA0	1	1 unit



3SU1250-0FB10-0AA0

Pushbuttons with raised button

Black	▶	3SU1250-0FB10-0AA0	1	1 unit
-------	---	---------------------------	---	--------



3SU1251-0EB20-0AA0

Pushbuttons with flat transparent button for insertion of insert labels

Red	3	3SU1251-0EB20-0AA0	1	1 unit
Clear	3	3SU1251-0EB70-0AA0	1	1 unit

Version	Material	Color	SD	Article No.	Price per PU	PU (UNIT, SET, M)	PS*
---------	----------	-------	----	-------------	--------------	-------------------	-----

Accessories



3SU1900-0KG10-0AA0

Extension plungers





Plastic	Gray	▶	3SU1900-0KG10-0AA0	1	1 unit
---------	------	---	---------------------------	---	--------

For compensation of the distance between the pushbutton and the unlatching button of an overload relay

3SU1 22 mm, Metal, Shiny — Actuating and Signaling Elements



Pushbuttons

Selection and ordering data

Version of actuating element Front ring version	Operating principle Unlatching method	Color, marking	SD	Article No.	Price per PU	PU (UNIT, SET, M)	PS*	
Pushbuttons								
 <p>3SU1050-0AB40-0AC0</p>	Pushbuttons with flat button Standard	Momentary contact	Black	▶	3SU1050-0AB10-0AA0		1	1 unit
			Black, "O"	▶	3SU1050-0AB10-0AD0		1	1 unit
			Red	▶	3SU1050-0AB20-0AA0		1	1 unit
			Red, "O"	▶	3SU1050-0AB20-0AD0		1	1 unit
			Yellow	3	3SU1050-0AB30-0AA0		1	1 unit
			Green	▶	3SU1050-0AB40-0AA0		1	1 unit
			Green, "I"	▶	3SU1050-0AB40-0AC0		1	1 unit
			Blue	3	3SU1050-0AB50-0AA0		1	1 unit
			Blue, "R"	5	3SU1050-0AB50-0AR0		1	1 unit
			White	3	3SU1050-0AB60-0AA0		1	1 unit
			White, "⊕"	5	3SU1050-0AB60-0AB0		1	1 unit
			White, "I"	▶	3SU1050-0AB60-0AC0		1	1 unit
			Clear	3	3SU1050-0AB70-0AA0		1	1 unit
			Gray	▶	3SU1050-0AB80-0AA0		1	1 unit
 <p>3SU1050-0AA30-0AA0</p>		Latching	Black	▶	3SU1050-0AA10-0AA0	1	1 unit	
		Push to unlatch	Red	▶	3SU1050-0AA20-0AA0	1	1 unit	
		Yellow	▶	3SU1050-0AA30-0AA0	1	1 unit		
		Green	▶	3SU1050-0AA40-0AA0	1	1 unit		
		Blue	▶	3SU1050-0AA50-0AA0	1	1 unit		
		White	▶	3SU1050-0AA60-0AA0	1	1 unit		
 <p>3SU1050-0BB20-0AA0</p>	Pushbuttons with raised button Standard	Momentary contact	Black	3	3SU1050-0BB10-0AA0	1	1 unit	
			Red	▶	3SU1050-0BB20-0AA0	1	1 unit	
			Yellow	▶	3SU1050-0BB30-0AA0	1	1 unit	
			Green	▶	3SU1050-0BB40-0AA0	1	1 unit	
			Blue	▶	3SU1050-0BB50-0AA0	1	1 unit	
		White	▶	3SU1050-0BB60-0AA0	1	1 unit		
		Latching	Red	5	3SU1050-0BA20-0AA0	1	1 unit	
Push to unlatch								
 <p>3SU1050-0CB50-0AA0</p>	Pushbuttons with flat button Raised	Momentary contact	Black	5	3SU1050-0CB10-0AA0	1	1 unit	
			Red	5	3SU1050-0CB20-0AA0	1	1 unit	
			Yellow	5	3SU1050-0CB30-0AA0	1	1 unit	
			Green	5	3SU1050-0CB40-0AA0	1	1 unit	
			Blue	5	3SU1050-0CB50-0AA0	1	1 unit	
			White	5	3SU1050-0CB60-0AA0	1	1 unit	
 <p>3SU1051-0CB40-0AA0</p>	Illuminated pushbuttons with flat button Raised NEW	Momentary contact	Green	X	3SU1051-0CB40-0AA0	1	20 units	

3SU1 22 mm, Metal, Shiny — Actuating and Signaling Elements





Pushbuttons

Version of actuating element	Operating principle	Color	SD	Article No.	Price per PU	PU (UNIT, SET, M)	PS*
Front ring version	Unlatching method		d				
Pushbuttons							
 <p>3SU1051-0AB30-0AA0</p>	Illuminated pushbuttons with flat button Standard	Momentary contact	Amber	5	3SU1051-0AB00-0AA0		1 1 unit
			Red	▶	3SU1051-0AB20-0AA0		1 1 unit
			Yellow	3	3SU1051-0AB30-0AA0		1 1 unit
			Green	▶	3SU1051-0AB40-0AA0		1 1 unit
			Blue	3	3SU1051-0AB50-0AA0		1 1 unit
			White	▶	3SU1051-0AB60-0AA0		1 1 unit
			Clear	▶	3SU1051-0AB70-0AA0		1 1 unit
		 <p>3SU1051-0AA20-0AA0</p>	Illuminated pushbuttons with raised button Standard	Latching	Red	▶	3SU1051-0AA20-0AA0
Push to unlatch	Yellow			▶	3SU1051-0AA30-0AA0		1 1 unit
	Green			▶	3SU1051-0AA40-0AA0		1 1 unit
	Blue			▶	3SU1051-0AA50-0AA0		1 1 unit
	White			▶	3SU1051-0AA60-0AA0		1 1 unit
	Clear			5	3SU1051-0AA70-0AA0		1 1 unit
	 <p>3SU1051-0BB20-0AA0</p>			Illuminated pushbuttons with raised button Standard	Momentary contact	Amber	5
		Red	▶		3SU1051-0BB20-0AA0		1 1 unit
		Yellow	▶		3SU1051-0BB30-0AA0		1 1 unit
		Green	▶		3SU1051-0BB40-0AA0		1 1 unit
		Blue	▶		3SU1051-0BB50-0AA0		1 1 unit
		White	5		3SU1051-0BB60-0AA0		1 1 unit
		Clear	3		3SU1051-0BB70-0AA0		1 1 unit

3SU1 22 mm, Metal, Shiny — Actuating and Signaling Elements

Twin pushbuttons

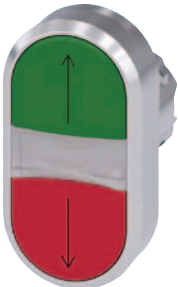
Selection and ordering data

Version of actuating element	Operating principle	Color	Marking Symbol No.	SD	Article No.	Price per PU	PU (UNIT, SET, M)	PS*
Twin pushbuttons								
 <p>3SU1050-3AB66-0AL0</p>	Twin pushbuttons flat, flat	Momentary contact	Green/Red	--	3		1	1 unit
			"I"/"O"	3				
			White/Black	--	3			
			"I"/"O"	3				
			White/White	--	3			
			"-"/"+"	5				
			Arrows, hor.	5				
			Black/Black	--	3			
			⊙	5				
			○	5				
5264/5265 (IEC 60417)								
 <p>3SU1050-3BB42-0AK0</p>	Twin pushbuttons flat, raised	Momentary contact	Green/Red	--	3		1	1 unit
			"I"/"O"	3				
			White/Black	--	3			
			"I"/"O"	5				
 <p>3SU1051-3AB42-0AN0</p>	Twin pushbuttons flat, flat, illuminated	Momentary contact	Green/Red	--	▶		1	1 unit
			"I"/"O"	▶				
			Arrows, vert.	5				
			White/Black	--	▶			
			"I"/"O"	3				
 <p>3SU1051-3BB61-0AA0</p>	Twin pushbuttons flat, raised, illuminated	Momentary contact	Green/Red	--	▶		1	1 unit
			"I"/"O"	▶				
			White/Black	--	3			
			"I"/"O"	5				

3SU1 22 mm, Metal, Shiny — Actuating and Signaling Elements

Mushroom pushbuttons

Selection and ordering data

Version of actuating element	Operating principle Unlatching method	Color	SD	Article No.	Price per PU	PU (UNIT, SET, M)	PS*
Mushroom pushbuttons							
2 switch positions							
	Momentary contact	Black	▶	3SU1050-1AD10-0AA0		1	1 unit
		Red	▶	3SU1050-1AD20-0AA0		1	1 unit
		Yellow	▶	3SU1050-1AD30-0AA0		1	1 unit
		Green	▶	3SU1050-1AD40-0AA0		1	1 unit
	Latching Pull to unlatch	Black	▶	3SU1050-1AA10-0AA0		1	1 unit
		Red	▶	3SU1050-1AA20-0AA0		1	1 unit
Mushroom pushbuttons							
	Momentary contact	Black	3	3SU1050-1BD10-0AA0		1	1 unit
		Red	5	3SU1050-1BD20-0AA0		1	1 unit
		Yellow	5	3SU1050-1BD30-0AA0		1	1 unit
		Green	5	3SU1050-1BD40-0AA0		1	1 unit
	Latching Pull to unlatch	Black	3	3SU1050-1BA10-0AA0		1	1 unit
		Red	3	3SU1050-1BA20-0AA0		1	1 unit
		Yellow	5	3SU1050-1BA30-0AA0		1	1 unit
Mushroom pushbuttons							
	Momentary contact	Black	5	3SU1050-1CD10-0AA0		1	1 unit
		Red	5	3SU1050-1CD20-0AA0		1	1 unit
		Yellow	5	3SU1050-1CD30-0AA0		1	1 unit
		Green	5	3SU1050-1CD40-0AA0		1	1 unit
	Latching Pull to unlatch	Black	5	3SU1050-1CA10-0AA0		1	1 unit
		Red	5	3SU1050-1CA20-0AA0		1	1 unit
Mushroom pushbuttons							
	Momentary contact	Yellow	5	3SU1051-1AD30-0AA0		1	1 unit
		Green	5	3SU1051-1AD40-0AA0		1	1 unit
		White	5	3SU1051-1AD60-0AA0		1	1 unit
	Latching Pull to unlatch	Amber	5	3SU1051-1AA00-0AA0		1	1 unit
		Red	5	3SU1051-1AA20-0AA0		1	1 unit
		Yellow	5	3SU1051-1AA30-0AA0		1	1 unit
		Green	5	3SU1051-1AA40-0AA0		1	1 unit
		Blue	5	3SU1051-1AA50-0AA0		1	1 unit
		Clear	5	3SU1051-1AA70-0AA0		1	1 unit
Mushroom pushbuttons							
	Momentary contact	Amber	5	3SU1051-1BD00-0AA0		1	1 unit
		Yellow	5	3SU1051-1BD30-0AA0		1	1 unit
		Green	5	3SU1051-1BD40-0AA0		1	1 unit
		White	5	3SU1051-1BD60-0AA0		1	1 unit
	Latching Pull to unlatch	Amber	5	3SU1051-1BA00-0AA0		1	1 unit
		Red	3	3SU1051-1BA20-0AA0		1	1 unit
		Yellow	5	3SU1051-1BA30-0AA0		1	1 unit
		Green	5	3SU1051-1BA40-0AA0		1	1 unit
		Blue	5	3SU1051-1BA50-0AA0		1	1 unit
		Clear	5	3SU1051-1BA70-0AA0		1	1 unit
Mushroom pushbuttons							
	Momentary contact	Amber	5	3SU1051-1CD00-0AA0		1	1 unit
		Yellow	5	3SU1051-1CD30-0AA0		1	1 unit
		Green	5	3SU1051-1CD40-0AA0		1	1 unit
		White	5	3SU1051-1CD60-0AA0		1	1 unit
	Latching Pull to unlatch	Red	5	3SU1051-1CA20-0AA0		1	1 unit
		Yellow	5	3SU1051-1CA30-0AA0		1	1 unit
		Green	5	3SU1051-1CA40-0AA0		1	1 unit
		Blue	5	3SU1051-1CA50-0AA0		1	1 unit
		Clear	5	3SU1051-1CA70-0AA0		1	1 unit

3SU1 22 mm, Metal, Shiny — Actuating and Signaling Elements

Mushroom pushbuttons / EMERGENCY STOP mushroom pushbuttons

Version of actuating element	Operating principle Unlatching method	Color	SD	Article No.	Price per PU	PU (UNIT, SET, M)	PS*
------------------------------	--	-------	----	-------------	--------------	-------------------	-----

Mushroom pushbuttons

2 switch positions

Mushroom pushbuttons with raised mushroom, tamper-proof, 40 mm diameter, 2 positions

Latching	Black	5	3SU1050-1HB10-0AA0	1	1 unit
Rotate to unlatch	Yellow	5	3SU1050-1HB30-0AA0	1	1 unit



3SU1050-1HB10-0AA0

3 switch positions

Mushroom pushbuttons 40 mm diameter, 3 positions

Momentary contact	Black	5	3SU1050-1ED10-0AA0	1	1 unit
	Red	5	3SU1050-1ED20-0AA0	1	1 unit

Latching	Black	5	3SU1050-1EA10-0AA0	1	1 unit
	Red	5	3SU1050-1EA20-0AA0	1	1 unit

Pull to unlatch



3SU1050-1EA20-0AA0

Mushroom pushbuttons 40 mm diameter, 3 positions, illuminated

Momentary contact	Red	5	3SU1051-1ED20-0AA0	1	1 unit
	White	5	3SU1051-1ED60-0AA0	1	1 unit

Latching	Red	5	3SU1051-1EA20-0AA0	1	1 unit
	Green	5	3SU1051-1EA40-0AA0	1	1 unit

Pull to unlatch



3SU1051-1EA40-0AA0

Selection and ordering data

Version of actuating element	Outer diameter of mushroom	Make of lock	Color	SD	Article No.	Price per PU	PU (UNIT, SET, M)	PS*
------------------------------	----------------------------	--------------	-------	----	-------------	--------------	-------------------	-----

EMERGENCY STOP mushroom pushbuttons, in accordance with ISO 13850 and IEC 60947-5-5

With pull-to-unlatch mechanism

Tamper-proof, 40

--	Red	3	3SU1050-1HA20-0AA0	1	1 unit
----	-----	---	---------------------------	---	--------



3SU1050-1HA20-0AA0

With rotate-to-unlatch mechanism

Tamper-proof, 33.8

--	Red	3	3SU1050-1GB20-0AA0	1	1 unit
----	-----	---	---------------------------	---	--------



3SU1050-1GB20-0AA0



3SU1 22 mm, Metal, Shiny — Actuating and Signaling Elements

EMERGENCY STOP mushroom pushbuttons

Version of actuating element	Outer diameter of mushroom	Make of lock	Color	Number of keys	SD	Article No.	Price per PU	PU (UNIT, SET, M)	PS*
------------------------------	----------------------------	--------------	-------	----------------	----	-------------	--------------	-------------------	-----

EMERGENCY STOP mushroom pushbuttons, in accordance with ISO 13850 and IEC 60947-5-5



With rotate-to-unlatch mechanism

 3SU1050-1HB20-0AA0	Tamper-proof, 2 positions	40	--	Red	▶	3SU1050-1HB20-0AA0		1	1 unit
		60	--	Red	5	3SU1050-1JB20-0AA0		1	1 unit
 3SU1050-1JB20-0AA0									

With rotate-to-unlatch mechanism, can be illuminated

 3SU1051-1HB20-0AA0	Tamper-proof, 2 positions 33.8 40 60	--	Red	▶	3SU1051-1GB20-0AA0		1	1 unit
				▶	3SU1051-1HB20-0AA0		1	1 unit
				▶	3SU1051-1JB20-0AA0		1	1 unit

With key-operated release

 3SU1050-1HF20-0AA0	Tamper-proof, 2 positions 40	--	RONIS SB30	Red	2	3	3SU1050-1HF20-0AA0		1	1 unit
			RONIS 455		2	5	3SU1050-1HG20-0AA0		1	1 unit
			RONIS 421		2	5	3SU1050-1HH20-0AA0		1	1 unit
 3SU1050-1HQ20-0AA0			BKS S1	Red	2	5	3SU1050-1HK20-0AA0		1	1 unit
			BKS E7		0	5	3SU1050-1HM20-0AA0		1	1 unit
			BKS E9		0	5	3SU1050-1HN20-0AA0		1	1 unit
			O.M.R. 73037		2	5	3SU1050-1HQ20-0AA0		1	1 unit
 3SU1050-1HR20-0AA0			CES SSG10	Red	2	3	3SU1050-1HR20-0AA0		1	1 unit
			CES SSP9		2	5	3SU1050-1HS20-0AA0		1	1 unit
			CES VL5	Black	2	5	3SU1050-1HU10-0AA0		1	1 unit
				Red	2	5	3SU1050-1HU20-0AA0		1	1 unit
			CES VL1		2	5	3SU1050-1HV20-0AA0		1	1 unit
			IKON 360012K1		2	5	3SU1050-1HX20-0AA0		1	1 unit





3SU1 22 mm, Metal, Shiny — Actuating and Signaling Elements

Toggle switches / Selector switches

Selection and ordering data













Number of switching positions	Number of command points	Color of actuating element	Operating principle of the actuating element	SD	Article No.	Price per PU	PU (UNIT, SET, M)	PS*
Toggle switches								
 3SU1050-3EA10-0AA0	2	1	Black	Latching	5		1	1 unit
				Momentary contact, reset from above	5	3SU1050-3EC10-0AA0		1

Selection and ordering data

Version of actuating element	Operating principle	Color	SD	Article No.	Price per PU	PU (UNIT, SET, M)	PS*	
Selector switches								
2 switch positions, can be illuminated								
 3SU1052-2BC20-0AA0	Selector, short black actuator Momentary contact, 45° (10:30/12 o'clock), reset from center to left 	Black	3	3SU1052-2BC10-0AA0		1	1 unit	
		Red	▶	3SU1052-2BC20-0AA0		1	1 unit	
		Yellow	5	3SU1052-2BC30-0AA0		1	1 unit	
		Green	▶	3SU1052-2BC40-0AA0		1	1 unit	
		Blue	▶	3SU1052-2BC50-0AA0		1	1 unit	
		White	3	3SU1052-2BC60-0AA0		1	1 unit	
 3SU1052-2BF40-0AA0	Latching, 90° (10:30/1:30 o'clock) 	Amber	5	3SU1052-2BF00-0AA0		1	1 unit	
		Black	▶	3SU1052-2BF10-0AA0		1	1 unit	
		Red	3	3SU1052-2BF20-0AA0		1	1 unit	
		Green	3	3SU1052-2BF40-0AA0		1	1 unit	
		White	▶	3SU1052-2BF60-0AA0		1	1 unit	
 3SU1052-2CC60-0AA0	Selector, long black actuator Momentary contact, 45° (10:30/12 o'clock), reset from center to left 	Black	5	3SU1052-2CC10-0AA0		1	1 unit	
		Yellow	5	3SU1052-2CC30-0AA0		1	1 unit	
		Green	5	3SU1052-2CC40-0AA0		1	1 unit	
		Blue	5	3SU1052-2CC50-0AA0		1	1 unit	
		White	5	3SU1052-2CC60-0AA0		1	1 unit	
 3SU1052-2CF60-0AA0	Latching, 90° (10:30/1:30 o'clock) 	Black	5	3SU1052-2CF10-0AA0		1	1 unit	
		Red	5	3SU1052-2CF20-0AA0		1	1 unit	
		Yellow	5	3SU1052-2CF30-0AA0		1	1 unit	
		Green	5	3SU1052-2CF40-0AA0		1	1 unit	
		Blue	5	3SU1052-2CF50-0AA0		1	1 unit	
White	5	3SU1052-2CF60-0AA0		1	1 unit			

3SU1 22 mm, Metal, Shiny — Actuating and Signaling Elements









Selector switches

Version of actuating element	Operating principle	Color	SD	Article No.	Price per PU	PU (UNIT, SET, M)	PS*		
Selector switches									
3 switch positions, can be illuminated									
 3SU1052-2BM50-0AA0  3SU1052-2BL30-0AA0  3SU1052-2BN20-0AA0  3SU1052-2CL40-0AA0	Selector, short black actuator	Momentary contact, 2x45° (10:30/12/1:30 o'clock), reset from left + right 	Amber 5 Black ▶ 3SU1052-2BM10-0AA0 Red 5 3SU1052-2BM20-0AA0 Yellow 5 3SU1052-2BM30-0AA0 Green ▶ 3SU1052-2BM40-0AA0 Blue ▶ 3SU1052-2BM50-0AA0 White ▶ 3SU1052-2BM60-0AA0	3SU1052-2BM00-0AA0 3SU1052-2BM10-0AA0 3SU1052-2BM20-0AA0 3SU1052-2BM30-0AA0 3SU1052-2BM40-0AA0 3SU1052-2BM50-0AA0 3SU1052-2BM60-0AA0	1	1 unit	1	1 unit	
		Latching, 2x45° (10:30/12/1:30 o'clock)		Black ▶ 3SU1052-2BL10-0AA0 Red ▶ 3SU1052-2BL20-0AA0 Yellow ▶ 3SU1052-2BL30-0AA0 Green ▶ 3SU1052-2BL40-0AA0 White ▶ 3SU1052-2BL60-0AA0	3SU1052-2BL10-0AA0 3SU1052-2BL20-0AA0 3SU1052-2BL30-0AA0 3SU1052-2BL40-0AA0 3SU1052-2BL60-0AA0	1	1 unit	1	1 unit
		Momentary contact/latching, 2x45° (10:30/12/1:30 o'clock), reset from left, latching to the right		Black 5 3SU1052-2BP10-0AA0 Red 5 3SU1052-2BP20-0AA0 Green 5 3SU1052-2BP40-0AA0 White 5 3SU1052-2BP60-0AA0	3SU1052-2BP10-0AA0 3SU1052-2BP20-0AA0 3SU1052-2BP40-0AA0 3SU1052-2BP60-0AA0	1	1 unit	1	1 unit
		Latching/momentary contact, 2x45° (10:30/12/1:30 o'clock), reset from right, latching to the left		Black 3 3SU1052-2BN10-0AA0 Red 5 3SU1052-2BN20-0AA0 Green ▶ 3SU1052-2BN40-0AA0 White 3 3SU1052-2BN60-0AA0	3SU1052-2BN10-0AA0 3SU1052-2BN20-0AA0 3SU1052-2BN40-0AA0 3SU1052-2BN60-0AA0	1	1 unit	1	1 unit
		Selector, long black actuator	Momentary contact, 2x45° (10:30/12/1:30 o'clock), reset from left + right 	Black 3 3SU1052-2CM10-0AA0 Red 5 3SU1052-2CM20-0AA0 Green 5 3SU1052-2CM40-0AA0 White 3 3SU1052-2CM60-0AA0	3SU1052-2CM10-0AA0 3SU1052-2CM20-0AA0 3SU1052-2CM40-0AA0 3SU1052-2CM60-0AA0	1	1 unit	1	1 unit
		Latching, 2x45° (10:30/12/1:30 o'clock)		Black 5 3SU1052-2CL10-0AA0 Red 5 3SU1052-2CL20-0AA0 Green 5 3SU1052-2CL40-0AA0 White 5 3SU1052-2CL60-0AA0	3SU1052-2CL10-0AA0 3SU1052-2CL20-0AA0 3SU1052-2CL40-0AA0 3SU1052-2CL60-0AA0	1	1 unit	1	1 unit
		Momentary contact/latching, 2x45° (10:30/12/1:30 o'clock), reset from left, latching to the right		Black 5 3SU1052-2CP10-0AA0 Red 5 3SU1052-2CP20-0AA0 White 5 3SU1052-2CP60-0AA0	3SU1052-2CP10-0AA0 3SU1052-2CP20-0AA0 3SU1052-2CP60-0AA0	1	1 unit	1	1 unit
		Latching/momentary contact, 2x45° (10:30/12/1:30 o'clock), reset from right, latching to the left		Black 5 3SU1052-2CN10-0AA0 Red 5 3SU1052-2CN20-0AA0 White 5 3SU1052-2CN60-0AA0	3SU1052-2CN10-0AA0 3SU1052-2CN20-0AA0 3SU1052-2CN60-0AA0	1	1 unit	1	1 unit
		4 switch positions Rotary knob Latching, 4x90° (3/6/9/12 o'clock) 	White 3	3SU1050-2AS60-0AA0	1	1 unit	1	1 unit	

3SU1 22 mm, Metal, Shiny — Actuating and Signaling Elements

Key-operated switches

Selection and ordering data

Operating principle	Make of lock	Switch position for key removal	Number of keys	SD	Article No.	Price per PU	PU (UNIT, SET, M)	PS*	
Key-operated switches									
2 switch positions									
 <p>3SU1050-4BC01-0AA0</p> <p>Momentary contact, 45° (10:30/12 o'clock), reset from center to left</p> 	RONIS, SB30	O	2	3	3SU1050-4BC01-0AA0		1	1 unit	
	RONIS, 455	O	2	5	3SU1050-4CC01-0AA0		1	1 unit	
	O.M.R. 73037, red	O	2	5	3SU1050-4FC01-0AA0		1	1 unit	
	O.M.R. 73038, light blue	O	2	5	3SU1050-4GC01-0AA0		1	1 unit	
	O.M.R. 73034, black	O	2	5	3SU1050-4HC01-0AA0		1	1 unit	
	O.M.R. 73033, yellow	O	2	5	3SU1050-4JC01-0AA0		1	1 unit	
	CES, SSG10	O	2	3	3SU1050-5BC01-0AA0		1	1 unit	
	CES, LSG1	O	2	5	3SU1050-5HC01-0AA0		1	1 unit	
	CES, VL5	O	2	5	3SU1050-5KC01-0AA0		1	1 unit	
	CES, STGH10	O	2	5	3SU1050-5LC01-0AA0		1	1 unit	
	BKS, S1	O	2	5	3SU1050-5PC01-0AA0		1	1 unit	
	IKON, 360012K1	O	2	5	3SU1050-5XC01-0AA0		1	1 unit	
	 <p>3SU1050-4BF01-0AA0</p> <p>Latching, 90° (10:30/1:30 o'clock)</p> 	RONIS, SB30	O	2	3	3SU1050-4BF01-0AA0		1	1 unit
		O+I	2	3	3SU1050-4BF11-0AA0		1	1 unit	
		I	2	5	3SU1050-4BF21-0AA0		1	1 unit	
RONIS, 455		O	2	5	3SU1050-4CF01-0AA0		1	1 unit	
		O+I	2	5	3SU1050-4CF11-0AA0		1	1 unit	
		I	2	5	3SU1050-4CF21-0AA0		1	1 unit	
RONIS, 421		O+I	2	5	3SU1050-4DF11-0AA0		1	1 unit	
O.M.R. 73037, red		O	2	5	3SU1050-4FF01-0AA0		1	1 unit	
		O+I	2	5	3SU1050-4FF11-0AA0		1	1 unit	
		I	2	5	3SU1050-4FF21-0AA0		1	1 unit	
 <p>3SU1050-4GF11-0AA0</p>	O.M.R. 73038, light blue	O	2	5	3SU1050-4GF01-0AA0		1	1 unit	
		O+I	2	5	3SU1050-4GF11-0AA0		1	1 unit	
		I	2	5	3SU1050-4GF21-0AA0		1	1 unit	
	O.M.R. 73034, black	O	2	5	3SU1050-4HF01-0AA0		1	1 unit	
		O+I	2	5	3SU1050-4HF11-0AA0		1	1 unit	
		I	2	5	3SU1050-4HF21-0AA0		1	1 unit	
	O.M.R. 73033, yellow	O	2	5	3SU1050-4JF01-0AA0		1	1 unit	
		O+I	2	5	3SU1050-4JF11-0AA0		1	1 unit	
		I	2	5	3SU1050-4JF21-0AA0		1	1 unit	
	 <p>3SU1050-5BF01-0AA0</p>	CES, SSG10	O	2	3	3SU1050-5BF01-0AA0		1	1 unit
		O+I	2	3	3SU1050-5BF11-0AA0		1	1 unit	
		I	2	5	3SU1050-5BF21-0AA0		1	1 unit	
CES, LSG1		O	2	5	3SU1050-5HF01-0AA0		1	1 unit	
		O+I	2	5	3SU1050-5HF11-0AA0		1	1 unit	
CES, VL5		O	2	5	3SU1050-5KF01-0AA0		1	1 unit	
CES, STGH10		O+I	2	5	3SU1050-5LF11-0AA0		1	1 unit	
 <p>3SU1050-5PF01-0AA0</p>		BKS, S1	O	2	5	3SU1050-5PF01-0AA0		1	1 unit
			O+I	2	5	3SU1050-5PF11-0AA0		1	1 unit
			I	2	5	3SU1050-5PF21-0AA0		1	1 unit
	BKS, E1	O	0	5	3SU1050-5QF01-0AA0		1	1 unit	
		O+I	0	5	3SU1050-5QF11-0AA0		1	1 unit	
	BKS, E2	O	0	3	3SU1050-5RF01-0AA0		1	1 unit	
		O+I	0	5	3SU1050-5RF11-0AA0		1	1 unit	
	BKS, E7	O	0	5	3SU1050-5SF01-0AA0		1	1 unit	
		O+I	0	5	3SU1050-5SF11-0AA0		1	1 unit	
	BKS, E9	O	0	5	3SU1050-5TF01-0AA0		1	1 unit	
	O+I	0	5	3SU1050-5TF11-0AA0		1	1 unit		
 <p>3SU1050-5XF01-0AA0</p>	IKON, 360012K1	O	2	5	3SU1050-5XF01-0AA0		1	1 unit	
		O+I	2	5	3SU1050-5XF11-0AA0		1	1 unit	

3SU1 22 mm, Metal, Shiny — Actuating and Signaling Elements

Key-operated switches

Operating principle	Make of lock	Switch position for key removal	Number of keys	SD	Article No.	Price per PU	PU (UNIT, SET, M)	PS*
---------------------	--------------	---------------------------------	----------------	----	-------------	--------------	-------------------	-----

Key-operated switches

3 switch positions



3SU1050-4BM01-0AA0

Momentary contact, 2x45° (10:30/12/1:30 o'clock), reset from left + right



Latching, 2x45° (10:30/12/1:30 o'clock)



3SU1050-4FL11-0AA0



3SU1050-5BL01-0AA0



3SU1050-4BP01-0AA0

Momentary contact/latching, 2x45° (10:30/12/1:30 o'clock), reset from left, latching to the right



Latching/momentary contact, 2x45° (10:30/12/1:30 o'clock), reset from right, latching to the left



RONIS, SB30	O	2	5	3SU1050-4BM01-0AA0	1	1 unit
RONIS, 455	O	2	5	3SU1050-4CM01-0AA0	1	1 unit
O.M.R. 73034, black	O	2	5	3SU1050-4HM01-0AA0	1	1 unit
CES, SSG10	O	2	5	3SU1050-5BM01-0AA0	1	1 unit
CES, STGH10	O	2	5	3SU1050-5LM01-0AA0	1	1 unit
BKS, S1	O	2	5	3SU1050-5PM01-0AA0	1	1 unit
IKON, 360012K1	O	2	5	3SU1050-5XM01-0AA0	1	1 unit
RONIS, SB30	O	2	5	3SU1050-4BL01-0AA0	1	1 unit
	I+O+II	2	3	3SU1050-4BL11-0AA0	1	1 unit
	I	2	5	3SU1050-4BL21-0AA0	1	1 unit
	II	2	5	3SU1050-4BL31-0AA0	1	1 unit
	I+II	2	5	3SU1050-4BL41-0AA0	1	1 unit
	O+I	2	5	3SU1050-4BL51-0AA0	1	1 unit
RONIS, 455	O	2	5	3SU1050-4CL01-0AA0	1	1 unit
	I+O+II	2	5	3SU1050-4CL11-0AA0	1	1 unit
RONIS, 421		2	5	3SU1050-4DL11-0AA0	1	1 unit
O.M.R. 73037, red	I+O+II	2	5	3SU1050-4FL11-0AA0	1	1 unit
O.M.R. 73038, light blue	O	2	5	3SU1050-4GL01-0AA0	1	1 unit
	I+O+III	2	5	3SU1050-4GL11-0AA0	1	1 unit
O.M.R. 73034, black	O	2	5	3SU1050-4HL01-0AA0	1	1 unit
	I+O+II	2	5	3SU1050-4HL11-0AA0	1	1 unit
CES, SSG10	O	2	5	3SU1050-5BL01-0AA0	1	1 unit
	I+O+II	2	3	3SU1050-5BL11-0AA0	1	1 unit
	I	2	5	3SU1050-5BL21-0AA0	1	1 unit
	II	2	5	3SU1050-5BL31-0AA0	1	1 unit
	I+II	2	5	3SU1050-5BL41-0AA0	1	1 unit
BKS, S1	O	2	5	3SU1050-5PL01-0AA0	1	1 unit
	I+O+II	2	5	3SU1050-5PL11-0AA0	1	1 unit
	I	2	5	3SU1050-5PL21-0AA0	1	1 unit
	I+II	2	5	3SU1050-5PL41-0AA0	1	1 unit
IKON, 360012K1	O	2	5	3SU1050-5XL01-0AA0	1	1 unit
	I+O+II	2	5	3SU1050-5XL11-0AA0	1	1 unit
RONIS, SB30	O	2	5	3SU1050-4BP01-0AA0	1	1 unit
	O+II	2	5	3SU1050-4BP61-0AA0	1	1 unit
O.M.R. 73034, black	II	2	5	3SU1050-4HP31-0AA0	1	1 unit
O.M.R. 73033, yellow	II	2	5	3SU1050-4JP31-0AA0	1	1 unit
CES, SSG10	O	2	5	3SU1050-5BP01-0AA0	1	1 unit
	II	2	5	3SU1050-5BP31-0AA0	1	1 unit
	O+II	2	5	3SU1050-5BP61-0AA0	1	1 unit
BKS, S1	O	2	5	3SU1050-5PP01-0AA0	1	1 unit
RONIS, SB30	O	2	5	3SU1050-4BN01-0AA0	1	1 unit
	I	2	5	3SU1050-4BN21-0AA0	1	1 unit
	O+IO+I	2	5	3SU1050-4BN51-0AA0	1	1 unit
CES, SSG10	O	2	5	3SU1050-5BN01-0AA0	1	1 unit
	I	2	5	3SU1050-5BN21-0AA0	1	1 unit
	O+I	2	5	3SU1050-5BN51-0AA0	1	1 unit
CES, STGH10	O+I	2	5	3SU1050-5LN51-0AA0	1	1 unit
BKS, S1	O	2	5	3SU1050-5PN01-0AA0	1	1 unit
	I	2	5	3SU1050-5PN21-0AA0	1	1 unit
	O+I	2	5	3SU1050-5PN51-0AA0	1	1 unit

3SU1 22 mm, Metal, Shiny — Actuating and Signaling Elements

Key-operated switches / Indicator lights

Selection and ordering data

Number of NO contacts (1 per direction)	Operating principle	Direction of actuation	SD	Screw terminals 	PU (UNIT, SET, M)	PS*
				Article No.	Price per PU	

Coordinate switches

Without mechanical interlock, 2 switch positions

2	Momentary contact	Horizontal	▶	3SU1050-7AC88-0AA0	1	1 unit
		Vertical	▶	3SU1050-7AD88-0AA0	1	1 unit
NEW	Latching	Horizontal	▶	3SU1050-7AA88-0AA0	1	1 unit
		Vertical	▶	3SU1050-7AB88-0AA0	1	1 unit

Without mechanical interlock, 4 switch positions

4	Momentary contact	Horizontal/Vertical	▶	3SU1150-7AF88-0AA0	1	1 unit
	Latching	Horizontal/Vertical	▶	3SU1150-7AE88-0AA0	1	1 unit

With mechanical interlock, 2 switch positions

2	Momentary contact	Horizontal	▶	3SU1050-7BC88-0AA0	1	1 unit
		Vertical	▶	3SU1050-7BD88-0AA0	1	1 unit
NEW	Latching	Horizontal	▶	3SU1050-7BA88-0AA0	1	1 unit
		Vertical	▶	3SU1050-7BB88-0AA0	1	1 unit

With mechanical interlock, 4 switch positions

4	Momentary contact	Horizontal/Vertical	▶	3SU1050-7BF88-0AA0	1	1 unit
	Latching	Horizontal/Vertical	▶	3SU1050-7BE88-0AA0	1	1 unit



3SU1050-7AC88-0AA0



3SU1050-7BC88-0AA0

Selection and ordering data

Type of product	Color	SD	Article No.	Price per PU	PU (UNIT, SET, M)	PS*
-----------------	-------	----	-------------	--------------	-------------------	-----

Indicator lights

With smooth lens

	Amber	3	3SU1051-6AA00-0AA0		1	1 unit
	Red	▶	3SU1051-6AA20-0AA0		1	1 unit
	Yellow	▶	3SU1051-6AA30-0AA0		1	1 unit
	Green	▶	3SU1051-6AA40-0AA0		1	1 unit
	Blue	3	3SU1051-6AA50-0AA0		1	1 unit
	White	▶	3SU1051-6AA60-0AA0		1	1 unit
	Clear	3	3SU1051-6AA70-0AA0		1	1 unit

3SU1051-6AA40-0AA0

3SU1 30 mm, Round, Metal, Matte — Actuating & Signaling Elements

Pushbuttons

Overview



Actuators and indicators, flat, 30mm, metal, matte
(all devices are shipped including adapter)

- ① Actuator
- ② Adapter









Selection and ordering data

Version	Operating principle	Unlatching method	Color	DT	Order No.	PU (UNIT, SET, M)	PS*
Pushbuttons							
 3SU1060-0JB50-0AA0	Pushbuttons with flat button Momentary contact	---	Black	B	3SU1060-0JB10-0AA0	1	1 unit
			Red	B	3SU1060-0JB20-0AA0	1	1 unit
			Yellow	B	3SU1060-0JB30-0AA0	1	1 unit
			Green	B	3SU1060-0JB40-0AA0	1	1 unit
			Blue	B	3SU1060-0JB50-0AA0	1	1 unit
			White	B	3SU1060-0JB60-0AA0	1	1 unit
 3SU1060-0JA20-0AA0	Latching Push to unlatch	---	Black	B	3SU1060-0JA10-0AA0	1	1 unit
			Red	B	3SU1060-0JA20-0AA0	1	1 unit
			Yellow	B	3SU1060-0JA30-0AA0	1	1 unit
			Green	B	3SU1060-0JA40-0AA0	1	1 unit
			Blue	B	3SU1060-0JA50-0AA0	1	1 unit
			White	B	3SU1060-0JA60-0AA0	1	1 unit
 3SU1061-0JB40-0AA0	Illuminated pushbuttons with flat button Momentary contact	---	Red	B	3SU1061-0JB20-0AA0	1	1 unit
			Yellow	B	3SU1061-0JB30-0AA0	1	1 unit
			Green	B	3SU1061-0JB40-0AA0	1	1 unit
			Blue	B	3SU1061-0JB50-0AA0	1	1 unit
			Clear	B	3SU1061-0JB70-0AA0	1	1 unit
 3SU1061-0JA30-0AA0	Latching Push to unlatch	---	Red	B	3SU1061-0JA20-0AA0	1	1 unit
			Yellow	B	3SU1061-0JA30-0AA0	1	1 unit
			Green	B	3SU1061-0JA40-0AA0	1	1 unit
			Blue	B	3SU1061-0JA50-0AA0	1	1 unit
			Clear	B	3SU1061-0JA70-0AA0	1	1 unit

3SU1 30 mm, Round, Metal, Matte — Actuating & Signaling Elements

Selector switches

Selection and ordering data

Version	Operating principle	Color	DT	Article No.	Price per PU	PU (UNIT, SET, M)	PS*
Selector switches							
2 switch positions, can be illuminated							
 <p>3SU1062-2DC40-0AA0</p>	Selector, short black actuator and front ring for flat mounting Momentary contact, 45° (10:30/12 o'clock), reset from center to left	Black	B	3SU1062-2DC10-0AA0		1	1 unit
		Red	B	3SU1062-2DC20-0AA0		1	1 unit
		Green	B	3SU1062-2DC40-0AA0		1	1 unit
		White	B	3SU1062-2DC60-0AA0		1	1 unit
 <p>3SU1062-2DF10-0AA0</p>	Latching, 90° (10:30/1:30 o'clock) Momentary contact, 45° (10:30/12 o'clock), reset from center to left	Black	B	3SU1062-2DF10-0AA0		1	1 unit
		Red	B	3SU1062-2DF20-0AA0		1	1 unit
		Green	B	3SU1062-2DF40-0AA0		1	1 unit
		Blue	B	3SU1062-2DF50-0AA0		1	1 unit
		White	B	3SU1062-2DF60-0AA0		1	1 unit
 <p>3SU1062-2EC20-0AA0</p>	Selector, long black actuator and front ring for flat mounting Momentary contact, 45° (10:30/12 o'clock), reset from center to left	Black	B	3SU1062-2EC10-0AA0		1	1 unit
		Red	B	3SU1062-2EC20-0AA0		1	1 unit
		Green	B	3SU1062-2EC40-0AA0		1	1 unit
		White	B	3SU1062-2EC60-0AA0		1	1 unit
 <p>3SU1062-2EF10-0AA0</p>	Latching, 90° (10:30/1:30 o'clock) Momentary contact, 45° (10:30/12 o'clock), reset from center to left	Black	B	3SU1062-2EF10-0AA0		1	1 unit
		Red	B	3SU1062-2EF20-0AA0		1	1 unit
		Green	B	3SU1062-2EF40-0AA0		1	1 unit
		White	B	3SU1062-2EF60-0AA0		1	1 unit
3 switch positions (I+O+II), can be illuminated							
 <p>3SU1062-2DM60-0AA0</p>	Selector, short black actuator and front ring for flat mounting Momentary contact, 2x45° (10:30/12/1:30 o'clock), reset from right + left	Black	B	3SU1062-2DM10-0AA0		1	1 unit
		Red	B	3SU1062-2DM20-0AA0		1	1 unit
		Green	B	3SU1062-2DM40-0AA0		1	1 unit
		White	B	3SU1062-2DM60-0AA0		1	1 unit
 <p>3SU1062-2DL60-0AA0</p>	Latching, 2x45° (10:30/12/1:30 o'clock) Momentary contact, 2x45° (10:30/12/1:30 o'clock), reset from right + left	Black	B	3SU1062-2DL10-0AA0		1	1 unit
		Red	B	3SU1062-2DL20-0AA0		1	1 unit
		Blue	B	3SU1062-2DL30-0AA0		1	1 unit
		Green	B	3SU1062-2DL40-0AA0		1	1 unit
		White	B	3SU1062-2DL60-0AA0		1	1 unit
 <p>3SU1062-2EM20-0AA0</p>	Selector, long black actuator and front ring for flat mounting Momentary contact, 2x45° (10:30/12/1:30 o'clock), reset from right + left	Black	B	3SU1062-2EM10-0AA0		1	1 unit
		Red	B	3SU1062-2EM20-0AA0		1	1 unit
		Green	B	3SU1062-2EM40-0AA0		1	1 unit
		White	B	3SU1062-2EM60-0AA0		1	1 unit
 <p>3SU1062-2EL20-0AA0</p>	Latching, 2x45° (10:30/12/1:30 o'clock) Momentary contact, 2x45° (10:30/12/1:30 o'clock), reset from right + left	Black	B	3SU1062-2EL10-0AA0		1	1 unit
		Red	B	3SU1062-2EL20-0AA0		1	1 unit
		Green	B	3SU1062-2EL40-0AA0		1	1 unit
		White	B	3SU1062-2EL60-0AA0		1	1 unit

3SU1 30 mm, Round, Metal, Matte — Actuating & Signaling Elements

Key-operated switches / Indicator lights

Selection and ordering data

Make of lock	Operating principle	Switch position for key removal	DT	Order No.	PU (UNIT, SET, M)	PS*
--------------	---------------------	---------------------------------	----	-----------	-------------------	-----

Key-operated switches with 2 keys

2 switch positions (O+I)



3SU1060-4LF11-0AA0

RONIS, SB30 and front ring for flat mounting

Momentary contact, 45° (10:30/12 o'clock), reset from center to left



B **3SU1060-4LC01-0AA0**

1 1 unit

Latching, 90° (10:30/1:30 o'clock)



B **3SU1060-4LF11-0AA0**
B **3SU1060-4LF21-0AA0**

1 1 unit
1 1 unit

3 switch positions (I+O+II)



3SU1060-4LL11-0AA0

RONIS, SB30 and front ring for flat mounting

Latching, 2x45° (10:30/12/1:30 o'clock)



B **3SU1060-4LL11-0AA0**

1 1 unit

Selection and ordering data

Version	Operating principle	Color	DT	Order No.	PU (UNIT, SET, M)	PS*
---------	---------------------	-------	----	-----------	-------------------	-----

Indicator lights



3SU1061-0JD40-0AA0

Illuminated pushbuttons Fixed button with flat button

Red B **3SU1061-0JD20-0AA0**
Yellow B **3SU1061-0JD30-0AA0**
Green B **3SU1061-0JD40-0AA0**
Blue B **3SU1061-0JD50-0AA0**
Clear B **3SU1061-0JD70-0AA0**

1 1 unit
1 1 unit
1 1 unit
1 1 unit
1 1 unit

Actuators and Indicators, Customized Designs

Special locks

Options

Special locks for key-operated switches

The plastic and metal key-operated switches of type RONIS, BKS, CES and IKON can be optionally ordered with additional locks.

In this case **"-Z"**, the order code **"Y01"** and the required lock number must be added to the Order No. of the relevant key-operated switch for standard locking.

Order code	Y01
Normal delivery time	25 working days
Additional price per unit	On request
Ordering example	3SU1000-5BF01-0AA0-Z Y01 Z = SSG18

Ordering notes

- For all special locks, an additional price applies.
- The order code **"Y01"** must be quoted in accordance with the above tables. Automated processing of the order with a defined delivery time can be guaranteed only for correctly submitted orders.
- For applications in which access security is important and several lock numbers are used, we recommend the use of BKS or CES key-operated switches.
- Special locks for VW (E1, E2, ...) will be delivered without keys, all others with 2 keys.
- With RONIS, the special locks SB31, 421 and 455 are possible.

Master and master-pass key systems

The following key systems can be supplied with BKS, CES or IKON key-operated switches:

- Central lock systems
- Master key systems
- Central master key systems
- Master-pass key systems

When placing an order you must supplement the Order No. of the matching key-operated switches with **"-Z"** and quote the order code **"Y03"**.

Price and delivery time on request.

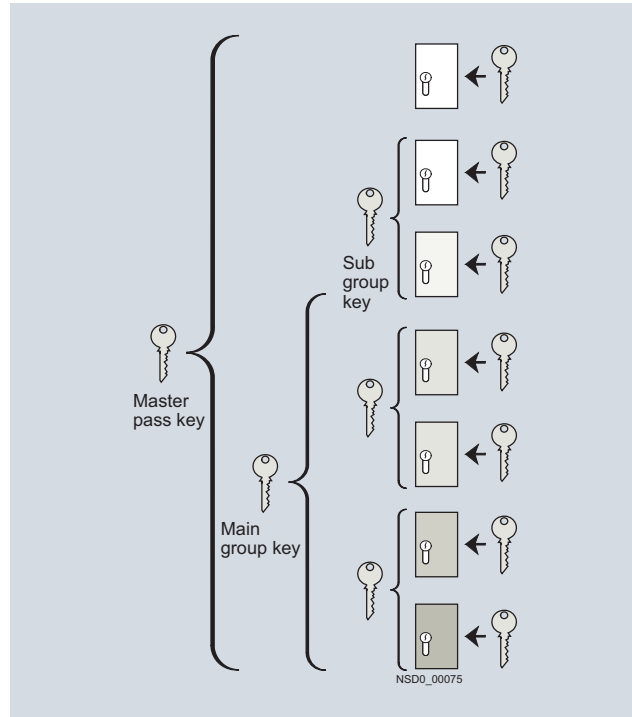

Example of master-pass key system

Actuators and Indicators, Customized Designs

Contact Block Selection Table for Selector Switches, Key-operated Switches, and 3-position push-pull

Selection and Ordering Data

Switch Position (front of switch)		Contact Block Circuit	Contact Block Position ¹⁾		Contact Block Order No.
Left	Right				

Two-Position Selector Switch Contact Block Selection

Switch Position (front of switch)		Contact Block Circuit	Contact Block Position ¹⁾		Contact Block Order No.
Left	Right				
O	X	1 NO	Any Position		3SU1400-1AA10-1BA0
X	O	1 NC	Any Position		3SU1400-1AA10-1CA0
O	X	1 NO/1 NC	Any Position		3SU1400-1AA10-1FA0
X	O				
O	X	2 NO	Any Position		3SU1400-1AA10-1DA0
O	X				
X	O	2 NC	Any Position		3SU1400-1AA10-1EA0
X	O				

Switch Position (front of switch)			Contact Block Circuit	Contact Block Position ¹⁾		Contact Block Order No.
Left	Center	Right		On Holder	Stacked	

Three-Position Selector Switch Contact Block Selection

Switch Position (front of switch)			Contact Block Circuit	Contact Block Position ¹⁾		Contact Block Order No.
Left	Center	Right		On Holder	Stacked	
X	O	O	1 NO	2 or 3A	5 or 6A	3SU1400-1AA10-1BA0
X	O	X	1 NO	3	6	3SU1400-1AA10-1BA0
O	O	X	1 NO	1 or 3B	4 or 6B	3SU1400-1AA10-1BA0
O	X	X	1 NC	2 or 3A	5 or 6A	3SU1400-1AA10-1CA0
O	X	O	1 NC	3	6	3SU1400-1AA10-1CA0
X	X	O	1 NC	1 or 3B	4 or 6B	3SU1400-1AA10-1CA0
X	O	O	1 NO/1 NC	2 or 3A	--	3SU1400-1AA10-1FA0
O	X	X				
X	O	X	1 NO/1 NC	3	--	3SU1400-1AA10-1FA0
O	X	O				
O	O	X	1 NO/1 NC	1 or 3B	--	3SU1400-1AA10-1FA0
X	X	O				
X	O	O	2 NO	2 or 3A	--	3SU1400-1AA10-1DA0
X	O	O				
X	O	X	2 NO	3	--	3SU1400-1AA10-1DA0
X	O	X				
O	O	X	2 NO	1 or 3B	--	3SU1400-1AA10-1DA0
O	O	X				
O	X	X	2 NC	2 or 3A	--	3SU1400-1AA10-1EA0
O	X	X				
O	X	O	2 NC	3	--	3SU1400-1AA10-1EA0
O	X	O				
X	X	O	2 NC	1 or 3B	--	3SU1400-1AA10-1EA0
X	X	O				

Three-Position Push-Pull Contact Block Selection

Out	Center	In	Contact Block Circuit	Contact Block Position ¹⁾		Contact Block Order No.
				On Holder	Stacked	
X	O	O	1 NO	2 or 3A	5 or 6A	3SU1400-1AA10-1BA0
O	O	X	1 NO	1 or 3B	4 or 6B	3SU1400-1AA10-1BA0
X	X	O	1 NC	1 or 3B	4 or 6B	3SU1400-1AA10-1CA0
O	X	X	1 NC	2 or 3A	5 or 6A	3SU1400-1AA10-1CA0
O	X	X	1 NO/1 NC	2 or 3A	--	3SU1400-1AA10-1FA0
X	O	O				
X	X	O	1 NO/1 NC	1 or 3B	--	3SU1400-1AA10-1FA0
O	O	X				
O	X	O	2 NC	3	--	3SU1400-1AA10-1FA0
X	O	X				

¹⁾ Single-element Contact Blocks are stackable (2 deep). Dual Contact Blocks are not stackable.

In order to attach a Light Module to the actuator, both plungers must be removed and Light Module placed in position #3.

Rear View	Plungers Inserted	Center Module Position Numbers	Replace the asterisks in center position numbers 3* or 6*:
	Both	3 or 6	Contact Blocks Position Number will be (3 or 6) when "Both" plungers are installed.
	Right	3B or 6B	Contact Blocks Position Number will be (3B or 6B) when "Right" plunger only is installed.
	Left	3A or 6A	Contact Blocks Position Number will be (3A or 6A) when "Left" plunger only is installed.
	None	None	Both plungers are removed if Center Module Position 3 is used with LED Light Module

X ----- Contact Closed
 O ----- Contact Open
 3 or 6 ----- Both Plungers Inserted
 3A or 6A --- Left Plunger Inserted
 3B or 6B --- Right Plunger Inserted

Actuators and Indicators, Customized Designs

Contact Block Selection Table for Selector – Switches and Key-operated Switches

Function Table

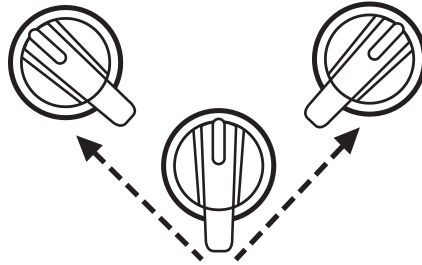

Plunger Position		Selector Switch Position ¹⁾					
Rear View	Front View	Left Position			Right Position		
		2	3	1	2	3	1
		■	■	□	□	■	■
		■	□	□	□	■	■
		■	■	□	□	□	■
		■	⊗	□	□	⊗	■

- Activated
- Not Activated
- ⊗ LED Available
- ☰ Plunger

¹⁾ The selector switch position is viewed from the front.
 All selector switches are packaged with two plungers, which can be removed manually.

Actuators and Indicators, Customized Designs

Laser inscriptions

Options

Inscription of actuating and signaling elements

Actuating and signaling elements of plastic as well as metal can be optionally inscribed with a laser.



Example of laser inscription

The actuators of the pushbuttons, illuminated pushbuttons, twin pushbuttons, mushroom pushbuttons, illuminated mushroom pushbuttons, EMERGENCY STOP mushroom pushbuttons (without lock), the lenses of the indicator lights, and the acoustic signaling devices can all be inscribed.

Version

Text inscriptions have centered alignment and a font height of 4 mm as standard.

The typeface used is Arial. Other letter heights and typefaces are possible, but must be specified when ordering.

The maximum possible number of characters per line is:

- 10 characters for one line of text
- 8 characters for 2 lines of text
- 6 characters for 3 lines of text, but 10 characters in the middle line

Note:

Selected pushbuttons and twin pushbuttons can be supplied as standard with inscribed letters or symbols.

Selector switches, key-operated switches and toggle switches can be inscribed on the front ring only if they are made of plastic (only one text line and the supplement Y19).

Assignment of the positions on the actuator

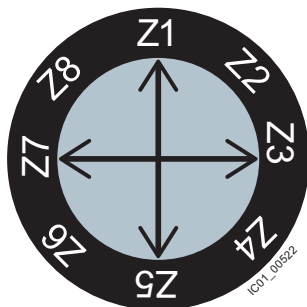

Ordering notes

To order, the inscribed actuating and signaling elements can be selected via the SIRIUS ACT Configurator. An electronic order form is then generated.

For configurator, see

- www.siemens.com/sirius-act/configurator
- Electronic Catalog CA 01 on DVD or
- Industry Mall: www.siemens.com/industrymall

When ordering, add **-Z** and an order code to the article number of the actuator or the indicator light:

- **Y10:** Text line in upper/lower case, all lines begin with upper case letters (e.g. line 1: Text/line 2: Text)
- **Y11:** Text in upper case (e.g. LIFT)
- **Y12:** Text in lower case (e.g. lift/off/lower)
- **Y15:** Text in upper/lower case, all words begin with upper case letters (e.g. On/Off)
- **Y13:** Symbol with number according to ISO 7000 or IEC 60417
- **Y19:** Inscription of choice, text or symbol, can only be ordered via SIRIUS ACT Configurator with a Configuration Identification Number (CIN)

When ordering, specify the required inscription in plain text without spaces, in addition to the article number and order code. In the case of special inscriptions with words in languages other than German, give the exact spelling and specify the language. In the case of symbols with number, quote the corresponding standard (see ordering example 1).

In the case of multi-line inscriptions, the text must be assigned to the respective line, e.g. Z1=Lift, Z2=Lower.

Symbols can also be ordered with numbers according to ISO 7000 or IEC 60417 (see ordering examples 2 and 3).

The SIRIUS ACT Configurator must be used to select special inscriptions and symbols (order code Y19). In this case a CIN (Configuration Identification Number) is generated for placement of future orders. It is then possible to place an order directly using the CIN and the SIRIUS ACT Configurator (Mall shopping cart) or via the standard ordering channels.

Ordering example 1

A round pushbutton with the inscription Reset is required:

3SU1030-0AB20-0AA0-Z

Y10

Z1=Reset

Ordering example 2

A pushbutton inscribed with symbol No. 5389 according to IEC 60417 is required:

3SU1030-0AB20-0AA0-Z

Y13

Z=5389 IEC

Ordering example 3

A selector switch with 2 switch positions and multi-line inscription on the front ring is required:

3SU1002-2BF10-0AA0-Z

Z8=0

Z2=1

Holders

Holders without module

Overview

Holders made of plastic can only be attached to actuators and indicators made of plastic (3SU100) or plastic with metal front ring (3SU103).

Metal holders can be attached to all versions of actuators and indicators. Metal holders are automatically grounded by their fastening screw, but a grounding stud can also be fitted.



Selection and ordering data

	Version	Holder material	DT	Order No.	PU (UNIT, SET, M)	PS*
Holders without module						
 3SU1500-0AA10-0AA0	3x without module	Plastic	A	3SU1500-0AA10-0AA0	1	1 unit
 3SU1500-0BA10-0AA0	4x without module For selector switch with 4 switch positions and for coordinate switches	Plastic	A	3SU1500-0BA10-0AA0	1	1 unit
Holders without module						
	Version	Holder material	DT	Order No.	PU (UNIT, SET, M)	PS*
 3SU1550-0AA10-0AA0	3x without module	Metal	A	3SU1550-0AA10-0AA0	1	1 unit
 3SU1550-0BA10-0AA0	4x without module For selector switch with 4 switch positions and for coordinate switches	Metal	A	3SU1550-0BA10-0AA0	1	1 unit

Holders

Holders with module

Selection and ordering data

Number of		SD	Screw terminals	PU (UNIT, SET, M)	PS*				
Contact modules	LED modules					NO cont.	NC cont.	Color of light source	
		d	Article No.	Price per PU					
Holders with module									
3x with module, plastic									
	1	0	1	0	--	▶ 3SU1500-1AA10-1BA0	1	1 unit	
						▶ 3SU1500-1AA10-1CA0	1	1 unit	
						▶ 3SU1500-1AA10-1FA0	1	1 unit	
	2	0	2	0	--	▶ 3SU1500-1AA10-1NA0	1	1 unit	
						▶ 3SU1500-1AA10-1PA0	1	1 unit	
						▶ 3SU1500-1AA10-1LA0	1	1 unit	
3x with contact and LED module¹⁾ (6 ... 24 V AC/DC)									
	1	1	1	0		Amber 3	3SU1501-1AG00-1BA0	1	1 unit
						Red 3	3SU1501-1AG20-1BA0	1	1 unit
						Yellow 3	3SU1501-1AG30-1BA0	1	1 unit
						Green 3	3SU1501-1AG40-1BA0	1	1 unit
						Blue 3	3SU1501-1AG50-1BA0	1	1 unit
						White 3	3SU1501-1AG60-1BA0	1	1 unit
	0	1		1		Amber ⊕ 3	3SU1501-1AG00-1CA0	1	1 unit
						Red ⊕ 3	3SU1501-1AG20-1CA0	1	1 unit
						Yellow ⊕ 3	3SU1501-1AG30-1CA0	1	1 unit
						Green ⊕ 3	3SU1501-1AG40-1CA0	1	1 unit
						Blue ⊕ 3	3SU1501-1AG50-1CA0	1	1 unit
						White ⊕ 3	3SU1501-1AG60-1CA0	1	1 unit
	1	1		1		Amber ⊕ 3	3SU1501-1AG00-1FA0	1	1 unit
						Red ⊕ 3	3SU1501-1AG20-1FA0	1	1 unit
						Yellow ⊕ 3	3SU1501-1AG30-1FA0	1	1 unit
						Green ⊕ 3	3SU1501-1AG40-1FA0	1	1 unit
						Blue ⊕ 3	3SU1501-1AG50-1FA0	1	1 unit
						White ⊕ 3	3SU1501-1AG60-1FA0	1	1 unit
2	1	2	0		Amber ⊕ 3	3SU1501-1AG00-1NA0	1	1 unit	
					Red ⊕ 3	3SU1501-1AG20-1NA0	1	1 unit	
					Yellow ⊕ 3	3SU1501-1AG30-1NA0	1	1 unit	
					Green ⊕ 3	3SU1501-1AG40-1NA0	1	1 unit	
					Blue ⊕ 3	3SU1501-1AG50-1NA0	1	1 unit	
					White ⊕ 3	3SU1501-1AG60-1NA0	1	1 unit	
	2	2	2	2		Amber ⊕ 3	3SU1501-1AG00-1LA0	1	1 unit
						Red ⊕ 3	3SU1501-1AG20-1LA0	1	1 unit
						Yellow ⊕ 3	3SU1501-1AG30-1LA0	1	1 unit
						Green ⊕ 3	3SU1501-1AG40-1LA0	1	1 unit
						Blue ⊕ 3	3SU1501-1AG50-1LA0	1	1 unit
						White ⊕ 3	3SU1501-1AG60-1LA0	1	1 unit

¹⁾ Only for use with SIRIUS commanding and signaling devices.

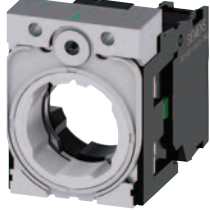
Number of		SD	Screw terminals	PU (UNIT, SET, M)	PS*	PG				
Contact modules	NO contacts						NC contacts	Color of light source		
		d	Article No.	Price per PU						
Holders with module										
3x with module, metal										
	1	1	0			3SU1550-1AA10-1BA0	1	1 unit	41J	
						3SU1550-1AA10-1CA0	1	1 unit	41J	
						3SU1550-1AA10-1FA0	1	1 unit	41J	
	2	2	0	2			3SU1550-1AA10-1NA0	1	1 unit	41J
							3SU1550-1AA10-1PA0	1	1 unit	41J
							3SU1550-1AA10-1LA0	1	1 unit	41J

⊕ Positive opening according to IEC 60947-5-1, Annex K.
 Can be used with 3SK11 safety relays or the 3RK3 Modular Safety System, see Section 13.

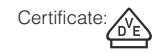

Modules for Actuators and Indicators

Contact modules

Overview

Contact modules and LED modules

The contact modules are fitted with slow-action contacts (NO contacts or NC contacts). These ensure a high switching reliability even with small voltages and currents, such as 5 V/1 mA. They are suitable for use in electronic systems as well as conventional controls. The contact pieces of the NC contacts are positively driven.

Only LED modules with permanently integrated LEDs are available for illumination.

Contact modules and LED modules bear terminal designations acc. to EN 50013.

Mounting the modules













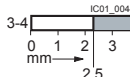

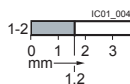
With SIRIUS ACT, the modules are mounted on the holder without any further accessories. Holders in plastic or metal versions are available for mounting three modules.

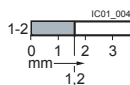
Connection methods

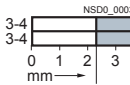
The modules are available with:

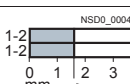
- Screw terminals
- Spring-type terminals or
- Solder pin connections (0.8 mm x 0.8 mm solder pins) for assembly on printed circuit boards

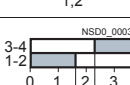
Selection and ordering data

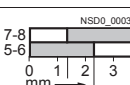
Contact version	Number of NO contacts	NC contacts	SD	Screw terminals		PU (UNIT, SET, M)	PS*	
				Article No.	Price per PU			
Contact modules for front plate mounting								
	Silver alloy	1	0			3SU1400-1AA10-1BA0	1	1 unit
		0	1			3SU1400-1AA10-1CA0	1	1 unit
		0	1 with installation monitoring ¹⁾			3SU1400-1AA10-1HA0	1	1 unit
		2	0			3SU1400-1AA10-1DA0	1	1 unit
		0	2			3SU1400-1AA10-1EA0	1	1 unit
		1	1			3SU1400-1AA10-1FA0	1	1 unit
		1 leading switching	1 lagging switching			3SU1400-1AA10-1GA0	1	1 unit

NEW











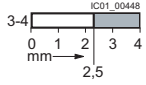

¹⁾ The contact module has 1 NO internal contact + 1 NC internal contact. The NO contact is connected in series with the NC contact and brought out at terminal 1-2. When the module is snapped onto the holder, the NO contact closes. It opens when the module is detached from the holder again (the NC contact remains closed). The NC contact opens when the EMERGENCY STOP device is actuated (the NO contact remains closed). The contact is closed only when both the NC and NO contacts are closed. Unsuitable for mounting in 3SU18 enclosure.

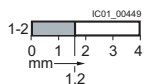
⊕ Positive opening according to IEC 60947-5-1, Annex K. Can be used with 3SK11 safety relays or the 3RK3 Modular Safety System, see Section 13.

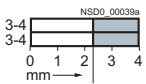
Certificate: 

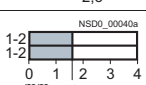
Modules for Actuators and Indicators

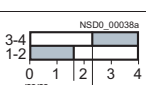
Contact modules

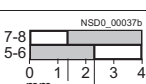
Contact version	Number of NO contacts	NC contacts		SD	Screw terminals 	PU (UNIT, SET, M)	PS*		
				d	Article No.	Price per PU			
Contact modules for front plate mounting <i>NEW</i>									
	Gold-plated	1	0			3	3SU1400-1AA10-1LA0	1	1 unit
		0	1			5	3SU1400-1AA10-1MA0	1	1 unit
		2	0			5	3SU1400-1AA10-1NA0	1	1 unit
		0	2			5	3SU1400-1AA10-1PA0	1	1 unit
		1	1			5	3SU1400-1AA10-1QA0	1	1 unit
		1 leading	1 lagging			5	3SU1400-1AA10-1RA0	1	1 unit

⊕ Positive opening according to IEC 60947-5-1, Annex K.
 Can be used with 3SK11 safety relays or the 3RK3 Modular Safety System,
 see Section 13.
 Certificate:



Modules for Actuators and Indicators

Contact modules

Contact version	Number of		SD	Spring-type terminals	PU (UNIT, SET, M)	PS*
	NO contacts	NC contacts				
Contact modules for front plate mounting				Article No.	Price per PU	
 3SU1400-1AA10-3BA0	Silver alloy	1	0		3SU1400-1AA10-3BA0	1 unit
		0	1		3SU1400-1AA10-3CA0	1 unit
 3SU1400-1AA10-3HA0		0	1 with installation monitoring ¹⁾		3SU1400-1AA10-3HA0	1 unit
	NEW	2	0		3SU1400-1AA10-3DA0	1 unit
 3SU1400-1AA10-3DA0	NEW	0	2		3SU1400-1AA10-3EA0	1 unit
	NEW	1	1		3SU1400-1AA10-3FA0	1 unit
 3SU1400-1AA10-3FA0	NEW	1 leading	1 lagging		3SU1400-1AA10-3GA0	1 unit

¹⁾ The contact module has 1 NO internal contact + 1 NC internal contact. The NO contact is connected in series with the NC contact and brought out at terminal 1-2. When the module is snapped onto the holder, the NO contact closes. It opens when the module is detached from the holder again (the NC contact remains closed). The NC contact opens when the EMERGENCY STOP device is actuated (the NO contact remains closed). The contact is closed only when both the NC and NO contacts are closed. Not suitable for installation in 3SU18 enclosure.

⊕ Positive opening according to IEC 60947-5-1, Annex K. Can be used with 3SK11 safety relays or the 3RK3 Modular Safety System, see Section 13. Certificate:



Modules for Actuators and Indicators

Contact modules

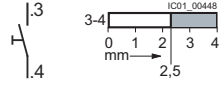
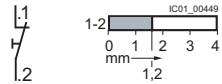
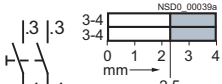
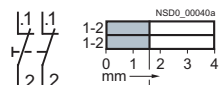
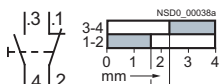
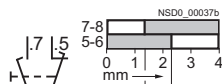
Contact version	Number of		SD	Spring-type terminals	PU (UNIT, SET, M)	PS*		
	NO contacts	NC contacts						
Contact modules for front plate mounting NEW				Article No.	Price per PU			
 3SU1400-1AA10-3LA0	Gold-plated	1	0		5	3SU1400-1AA10-3LA0	1	1 unit
		0	1		5	3SU1400-1AA10-3MA0	1	1 unit
		2	0		5	3SU1400-1AA10-3NA0	1	1 unit
		0	2		5	3SU1400-1AA10-3PA0	1	1 unit
		1	1		5	3SU1400-1AA10-3QA0	1	1 unit
		1 leading	1 lagging		5	3SU1400-1AA10-3RA0	1	1 unit



⊖ Positive opening according to IEC 60947-5-1, Annex K.
 Can be used with 3SK11 safety relays or the 3RK3 Modular Safety System,
 see Section 13.
 Certificate:



Modules for Actuators and Indicators

LED modules





Selection and ordering data

	Operational voltage at AC	Operational voltage at DC	Color	DT	Screw terminals	PU (UNIT, SET, M)	PS*
	V	V			Order No.		
 3SU1401-1BB30-1AA0	LED modules¹⁾ for front plate mounting						
	24	24	Amber	A	3SU1401-1BB00-1AA0	1	1 unit
			Red	▶	3SU1401-1BB20-1AA0	1	1 unit
			Yellow	▶	3SU1401-1BB30-1AA0	1	1 unit
			Green	▶	3SU1401-1BB40-1AA0	1	1 unit
			Blue	▶	3SU1401-1BB50-1AA0	1	1 unit
			White	▶	3SU1401-1BB60-1AA0	1	1 unit
	110	--	Amber	B	3SU1401-1BC00-1AA0	1	1 unit
			Red	▶	3SU1401-1BC20-1AA0	1	1 unit
			Yellow	▶	3SU1401-1BC30-1AA0	1	1 unit
			Green	▶	3SU1401-1BC40-1AA0	1	1 unit
			Blue	▶	3SU1401-1BC50-1AA0	1	1 unit
			White	▶	3SU1401-1BC60-1AA0	1	1 unit
	230	--	Amber	B	3SU1401-1BF00-1AA0	1	1 unit
			Red	▶	3SU1401-1BF20-1AA0	1	1 unit
			Yellow	▶	3SU1401-1BF30-1AA0	1	1 unit
		Green	▶	3SU1401-1BF40-1AA0	1	1 unit	
		Blue	▶	3SU1401-1BF50-1AA0	1	1 unit	
		White	▶	3SU1401-1BF60-1AA0	1	1 unit	
 3SU1401-1BB30-3AA0					Spring-type terminals		
	24	24	Amber	B	3SU1401-1BB00-3AA0	1	1 unit
			Red	▶	3SU1401-1BB20-3AA0	1	1 unit
			Yellow	▶	3SU1401-1BB30-3AA0	1	1 unit
			Green	▶	3SU1401-1BB40-3AA0	1	1 unit
			Blue	▶	3SU1401-1BB50-3AA0	1	1 unit
			White	▶	3SU1401-1BB60-3AA0	1	1 unit
	110	--	Amber	B	3SU1401-1BC00-3AA0	1	1 unit
			Red	▶	3SU1401-1BC20-3AA0	1	1 unit
			Yellow	B	3SU1401-1BC30-3AA0	1	1 unit
			Green	▶	3SU1401-1BC40-3AA0	1	1 unit
			Blue	B	3SU1401-1BC50-3AA0	1	1 unit
			White	▶	3SU1401-1BC60-3AA0	1	1 unit
	230	--	Amber	B	3SU1401-1BF00-3AA0	1	1 unit
			Red	▶	3SU1401-1BF20-3AA0	1	1 unit
			Yellow	B	3SU1401-1BF30-3AA0	1	1 unit
		Green	▶	3SU1401-1BF40-3AA0	1	1 unit	
		Blue	B	3SU1401-1BF50-3AA0	1	1 unit	
		White	▶	3SU1401-1BF60-3AA0	1	1 unit	



¹⁾ Only for use with SIRIUS commanding and signaling devices.



Modules for Actuators and Indicators

LED modules

Operational voltage at AC	Operational voltage at DC	Color	DT	Screw terminals 	PU (UNIT, SET, M)	PS*	
V	V			Order No.			
LED modules¹⁾ for front plate mounting							
 3SU1401-1BG30-1AA0	6 ... 24	6 ... 24	Amber	A	3SU1401-1BG00-1AA0	1	1 unit
			Red	▶	3SU1401-1BG20-1AA0	1	1 unit
			Yellow	▶	3SU1401-1BG30-1AA0	1	1 unit
			Green	▶	3SU1401-1BG40-1AA0	1	1 unit
			Blue	▶	3SU1401-1BG50-1AA0	1	1 unit
			White	▶	3SU1401-1BG60-1AA0	1	1 unit
			24 ... 240	24 ... 240	Amber	B	3SU1401-1BH00-1AA0
Red	▶	3SU1401-1BH20-1AA0			1	1 unit	
Yellow	▶	3SU1401-1BH30-1AA0			1	1 unit	
Green	▶	3SU1401-1BH40-1AA0			1	1 unit	
Blue	▶	3SU1401-1BH50-1AA0			1	1 unit	
White	▶	3SU1401-1BH60-1AA0			1	1 unit	
Spring-type terminals 							
 3SU1401-1BG30-3AA0	6 ... 24	6 ... 24	Amber	B	3SU1401-1BG00-3AA0	1	1 unit
			Red	▶	3SU1401-1BG20-3AA0	1	1 unit
			Yellow	▶	3SU1401-1BG30-3AA0	1	1 unit
			Green	▶	3SU1401-1BG40-3AA0	1	1 unit
			Blue	B	3SU1401-1BG50-3AA0	1	1 unit
			White	B	3SU1401-1BG60-3AA0	1	1 unit
			24 ... 240	24 ... 240	Amber	B	3SU1401-1BH00-3AA0
Red	B	3SU1401-1BH20-3AA0			1	1 unit	
Yellow	B	3SU1401-1BH30-3AA0			1	1 unit	
Green	▶	3SU1401-1BH40-3AA0			1	1 unit	
Blue	B	3SU1401-1BH50-3AA0			1	1 unit	
White	B	3SU1401-1BH60-3AA0			1	1 unit	

¹⁾ Only for use with SIRIUS commanding and signaling devices.

Operational voltage at AC	Operational voltage at DC	DT	Screw terminals 	PU (UNIT, SET, M)	PS*	
V	V		Order No.			
LED test modules¹⁾ for front plate mounting						
 3SU1401-1CK10-1AA0	12 ... 240	12 ... 240	▶	3SU1400-1CK10-1AA0	1	1 unit

Operational voltage at AC	Operational voltage at DC	Color	DT	Socket terminals (THT) 	PU (UNIT, SET, M)	PS*	
V	V			Order No.			
LED modules¹⁾ for mounting on printed circuit boards							
 3SU1401-3BA20-5AA0	--	5	Amber	B	3SU1401-3BA00-5AA0	1	1 unit
			Red	▶	3SU1401-3BA20-5AA0	1	1 unit
			Yellow	▶	3SU1401-3BA30-5AA0	1	1 unit
			Green	▶	3SU1401-3BA40-5AA0	1	1 unit
			Blue	▶	3SU1401-3BA50-5AA0	1	1 unit
			White	▶	3SU1401-3BA60-5AA0	1	1 unit

¹⁾ Only for use with SIRIUS commanding and signaling devices.









Modules for Actuators and Indicators

AS-Interface modules

Selection and ordering data

Operational voltage	Slave type	Number of digital inputs		Number of digital outputs	SD	Screw terminals + Spring-type terminals		PU (UNIT, SET, M)	PS*
		Standard	Safety-related			Article No.	Price per PU		

AS-Interface modules for front plate mounting

 3SU1400-1EA10-2AA0	30 V	2 F-DI	--	2	--	5	3SU1400-1EA10-2AA0	1	1 unit
		2 F-DI + 1 LED	Red	2	1	5	3SU1401-1EE20-2AA0	1	1 unit
 3SU1400-1EC10-2AA0		2 F-DI + 1 DQ	--	2	1	5	3SU1400-1EC10-2AA0	1	1 unit
									Insulation piercing method 
 3SU1400-1EA10-4AA0		2 F-DI	--	2	--	5	3SU1400-1EA10-4AA0	1	1 unit
		2 F-DI + 1 LED	Red	2	1	▶	3SU1401-1EE20-4AA0	1	1 unit
 3SU1400-1EC10-4AA0		2 F-DI + 1 DQ	--	2	1	5	3SU1400-1EC10-4AA0	1	1 unit
									Spring-type terminals + Insulation piercing method  
 3SU1400-1EJ10-6AA0	30 V	4 DI/3 DO AB	--	4	4	5	3SU1400-1EJ10-6AA0	1	1 unit
		4 DI/4 DO	--	4	4	5	3SU1400-1EK10-6AA0	1	1 unit

Modules for Actuators and Indicators

Electronic modules for IO-Link/support terminals

Selection and ordering data

Operational voltage	Slave type	Number of digital inputs	Number of digital outputs	SD	Spring-type terminals (push-in)	PU (UNIT, SET, M)	PS*
				d	Article No. Price per PU		
Electronic modules for IO-Link, front panel mounting							
24 V	Freely programmable (default 6 DI/2 DQ)	0 ... 8	0 ... 8	5	3SU1400-1HL10-6AA0	1	1 unit



3SU1400-1HL10-6AA0

Selection and ordering data

Color	SD	Screw terminals	PU (UNIT, SET, M)	PS*
	d	Article No. Price per PU		
Support terminals <i>NEW</i>				
Black	3	3SU1400-1DA10-1AA0	1	1 unit
Blue	5	3SU1400-1DA50-1AA0	1	1 unit
Green/Yellow	3	3SU1400-1DA43-1AA0	1	1 unit
<hr/>				
		Spring-type terminals		
Black	5	3SU1400-1DA10-3AA0	1	1 unit
Blue	5	3SU1400-1DA50-3AA0	1	1 unit
Green/Yellow	5	3SU1400-1DA43-3AA0	1	1 unit



3SU1400-1DA10-1AA0



3SU1400-1DA50-3AA0



Modules for Actuators and Indicators

Electronic modules for ID key-operated switches

Technical specifications

Order No.	3SU1400-1GC10-1AA0	3SU1400-1GD10-1AA0
Communication		
Protocol is supported by IO-Link protocol	No	Yes
Product function	Group ID 24 V DC	IO-Link 24 V DC
IO-Link transfer rate	--	COM2 (38.4 kBaud)
Point-to-point cycle time between the master and the IO-Link device minimum	ms --	10
Type of voltage supply via IO-Link master	--	3
Data volume		
• of the address area of the inputs with cyclic transfer total	bytes --	2
• of the address area of the outputs with cyclic transfer total	bytes --	0
Number of NO contacts	5	5
General data		
Impulse withstand voltage rated value	V 800	
Insulation voltage rated value	V 30	
Pollution degree	3	
Type of voltage		
• of operational voltage	DC	
• of input voltage	DC	
Operational voltage		
• 1 at DC rated value	V 24	
• Rated value	V 18 ... 30	
Current consumed maximum	mA 49	
Ambient temperature		
• During operation	°C -25 ... +70	
• During storage	°C -40 ... +80	
IP degree of protection	IP20	
Touch protection against electric shock	Finger-safe	
Connections		
Type of electrical connection	Screw terminals 	
Connectable conductor cross-section for auxiliary contacts		
• Solid or stranded	mm ² 0.2 ... 2.5	
• Solid		
- With end sleeves	mm ² 0.2 ... 0.75	
• Finely stranded		
- With end sleeves	mm ² 0.25 ... 1.5	
- Without end sleeves	mm ² 0.2 ... 2.5	
AWG number as coded connectable conductor cross-section		
• For auxiliary contacts	26 ... 14	
Tightening torque		
• For screw terminals	Nm 0.4 ... 0.8	

Selection and ordering data

	Type of voltage supply via IO-Link master	Protocol is supported IO-Link protocol	Number of NO contacts	IO-Link transfer rate	DT	Screw terminals 	PU (UNIT, SET, M)	PS*
	Order No.							
Electronic modules for ID key-operated switches								
	--	No	5	--	B	3SU1400-1GC10-1AA0	1	1 unit
3SU1400-1GC10-1AA0								
	Yes	Yes	5	COM2 (38.4 kBaud)	X	3SU1400-1GD10-1AA0	1	1 unit
3SU1400-1GD10-1AA0								
✓ Yes -- No								

Modules for Actuators and Indicators

Interface modules for PROFINET/terminal modules

Selection and ordering data

Supply voltage at DC	Number of interfaces according to PROFINET SIL claim limit acc. to EN 62061	Number of digital inputs	Number of digital outputs	SD	Article No.	Price per PU	PU (UNIT, SET, M)	PS*
V				d				

Interface modules for PROFINET **NEW**

Interface modules



3SU1400-1LK10-1AA1

24	1	0	0	5				
				5				

Screw terminals



3SU1400-1LK10-1AA1

1 1 unit

Spring-type terminals



3SU1400-1LK10-3AA1

1 1 unit

Fail-safe interface modules



3SU1400-1LL10-3BA1

24	1 SIL CL 3	4	1	5				
				5				

Screw terminals



3SU1400-1LL10-1BA1

1 1 unit

Spring-type terminals



3SU1400-1LL10-3BA1

1 1 unit

Type of product	Color of light source	SD	Insulation displacement connection	Price per PU	PU (UNIT, SET, M)	PS*
		d				

Terminal modules **NEW**



3SU1401-1ME60-1DA1

With 2 contacts	--	5	3SU1400-1MA10-1BA1		1	1 unit
With 2 contacts and integrated LED	Amber	5	3SU1401-1MC00-1CA1		1	1 unit
	Red	5	3SU1401-1MC20-1CA1		1	1 unit
	Yellow	5	3SU1401-1MC30-1CA1		1	1 unit
	Green	5	3SU1401-1MC40-1CA1		1	1 unit
	Blue	5	3SU1401-1MC50-1CA1		1	1 unit
	White	5	3SU1401-1MC60-1CA1		1	1 unit
With integrated LED	Amber	5	3SU1401-1ME00-1DA1		1	1 unit
	Red	5	3SU1401-1ME20-1DA1		1	1 unit
	Yellow	5	3SU1401-1ME30-1DA1		1	1 unit
	Green	5	3SU1401-1ME40-1DA1		1	1 unit
	Blue	5	3SU1401-1ME50-1DA1		1	1 unit
	White	5	3SU1401-1ME60-1DA1		1	1 unit

Type of product	SD	Article No.	Price per PU	PU (UNIT, SET, M)	PS*
	d				

Memory modules for 3SK2



3RK3931-0AA00

Memory module	2	3RK3931-0AA00		1	1 unit
----------------------	---	----------------------	--	---	--------

For backing up the complete parameterization of the 3SK2 safety system without a PC/PG through the system interface

Flat ribbon cable, [see page 10/156](#).

LED modules for mounting on printed-circuit boards, [see page 10/112](#).

Enclosures

General data

Overview

Design



Enclosures with standard fittings

Enclosed SIRIUS ACT pushbuttons and indicator lights are used as hand-operated commanding devices for separately allocated control units and cabinets. The devices are suitable for use in any climate.

Standards

IEC 60947-5-1 or EN 60947-5-1

Versions

The enclosed pushbuttons and indicator lights are available with conventional controls as well as for connection to AS-Interface. The following versions are available:

- Empty enclosures with 1 to 6 command points (the installed components must be ordered separately; use modules for base mounting)
- Enclosures with standard fittings with 1 to 3 command points, e.g. EMERGENCY STOP enclosure with EMERGENCY STOP mushroom pushbutton
- Enclosures with customized fittings with 1 to 6 command points

Color of the enclosures

Top:

- Gray, RAL 7035
- Yellow, RAL 1004 for EMERGENCY STOP

Base:

- Black, RAL 9005

Customized enclosures

The fittings and labeling of the command points can be chosen using the Configurator on the Internet, see: www.siemens.com/sirius-act/configurator

Application

The enclosures are climate-proof (KTW 24) according to EN ISO 6270-2 and suitable for stationary use, and for use in marine applications.

Enclosures with standard fittings

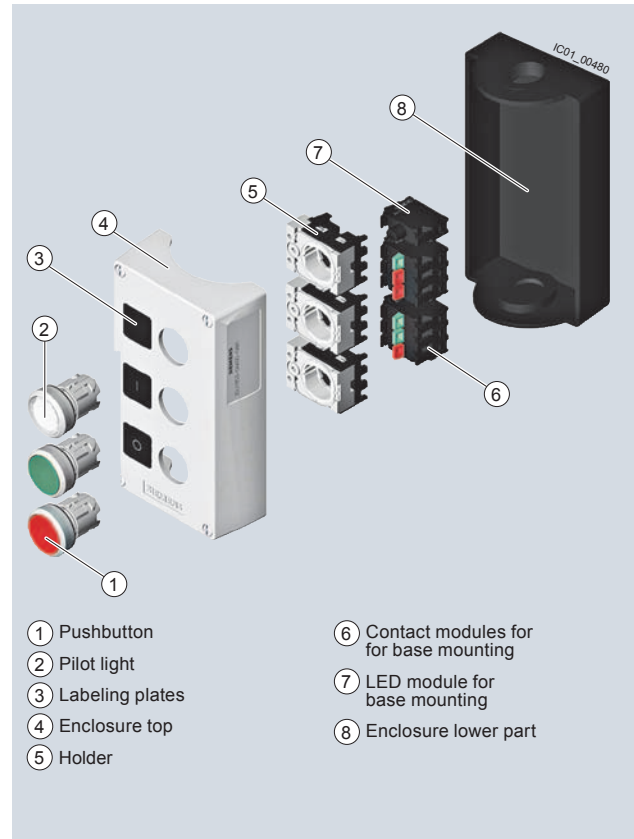

- | | |
|-------------------|-------------------------------------|
| ① Pushbutton | ⑥ Contact modules for base mounting |
| ② Pilot light | ⑦ LED module for base mounting |
| ③ Labeling plates | ⑧ Enclosure lower part |
| ④ Enclosure top | |
| ⑤ Holder | |

Pushbuttons and indicator lights in the enclosure

Nomenclature of command points









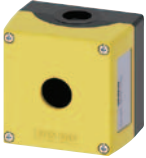

- 6th command point = F
- 5th command point = E
- 4th command point = D
- 3rd command point = C
- 2nd command point = B
- 1st command point = A

Enclosures

Empty enclosures

Selection and ordering data

Color of enclosure top	Number of command points	Enclosure version	SD	Article No.	Price per PU	PU (UNIT, SET, M)	PS*			
Enclosures for surface mounting										
Plastic										
	Yellow	1	Center command point	▶	3SU1801-0AA00-0AA2	1	1 unit			
			With protective collar	▶	3SU1801-0AA00-0AC2	1	1 unit			
			With recess for labeling plate	▶	3SU1801-0AA00-0AB2	1	1 unit			
	Gray	2	With recess for labeling plate	▶	3SU1802-0AA00-0AB2	1	1 unit			
			With recess for labeling plate	▶	3SU1801-0AA00-0AB1	1	1 unit			
			With recess for labeling plate	▶	3SU1802-0AA00-0AB1	1	1 unit			
			With recess for labeling plate	▶	3SU1803-0AA00-0AB1	1	1 unit			
			With recess for labeling plate	▶	3SU1804-0AA00-0AB1	1	1 unit			
	Gray	6	With recess for labeling plate	▶	3SU1806-0AA00-0AB1	1	1 unit			
			Metal							
				Yellow	1	Center command point	▶	3SU1851-0AA00-0AA2	1	1 unit
						With protective collar	3	3SU1851-0AA00-0AC2	1	1 unit
						With recess for labeling plate	▶	3SU1851-0AA00-0AB2	1	1 unit
	Gray	1	With protective collar for 5 padlocks, mushroom 40 mm	3	3SU1851-0AA00-0AF2	1	1 unit			
			With protective collar for 5 padlocks, mushroom 40 mm with key-operated release	3	3SU1851-0AA00-0AG2	1	1 unit			
			With protective collar for 5 padlocks, mushroom 60 mm	3	3SU1851-0AA00-0AH2	1	1 unit			
			With protective collar for 5 padlocks, mushroom 60 mm	3	3SU1851-0AA00-0AH1	1	1 unit			
	Gray	2	With recess for labeling plate	▶	3SU1851-0AA00-0AB1	1	1 unit			
			With protective collar	5	3SU1851-0AA00-0AC1	1	1 unit			
			With recess for labeling plate	▶	3SU1852-0AA00-0AB1	1	1 unit			
			With recess for labeling plate	▶	3SU1853-0AA00-0AB1	1	1 unit			
			With recess for labeling plate	▶	3SU1854-0AA00-0AB1	1	1 unit			
	Gray	6	With recess for labeling plate	▶	3SU1856-0AA00-0AB1	1	1 unit			
			Enclosure for 4-position selector switches, coordinate switches, ID key-operated switches and sensor switches							
Plastic, front plate mounting										
	Gray	1	Center command point	3	3SU1801-1AA00-1AA1	1	1 unit			
			Metal, front plate mounting							
	Gray	1	Center command point	5	3SU1851-1AA00-1AA1	1	1 unit			

Enclosures

Pushbuttons and indicator lights in the enclosure

Overview

Pushbuttons and indicator lights in the enclosure (standard fittings) are available with:

- 1 to 3 command points (equipped, for example, with A, B, C, in each case from bottom to top)
- Operational voltage up to 400 V
- Vertical mounting type
- Plastic enclosures are equipped with plastic actuators and indicators, metal enclosures are equipped with metal actuators and indicators
- Contact modules and LED modules for base mounting (are snapped into the enclosure base); screw terminals as standard; some versions also with spring-type terminals

Palm pushbuttons

Palm pushbuttons have a particularly large button surface. This means that they can be actuated quickly and easily with the hand, arm or foot.

Selection and ordering data

Color of enclosure top	Number of command points	Enclosure version Pushbutton and signaling device equipment	Color of actuating element Marking	Number of		SD	Article No.	Price per PU	PU (UNIT, SET, M)	PS*
				NC contacts	NO contacts					

Enclosures with standard fittings

Plastic



3SU1801-0NA00-2AA2



3SU1801-0NA00-2AC2







3SU1801-2NG00-2AA2

Yellow	1	Center command point A = EMERGENCY STOP mushroom pushbuttons, 40 mm, with positive latching acc. to ISO 13850, rotate to unlatch	Red	1	0	▶	3SU1801-0NA00-2AA2		1	1 unit
		With protective collar A = EMERGENCY STOP mushroom pushbuttons, 40 mm, with positive latching acc. to ISO 13850, rotate to unlatch	Red A = I	1	0	▶	3SU1801-0NA00-2AC2		1	1 unit
				2	0	▶	3SU1801-0NB00-2AC2		1	1 unit
	2	With recess for labeling plate A = EMERGENCY STOP mushroom pushbuttons, 40 mm, with positive latching acc. to ISO 13850, rotate to unlatch B = Indicator light 24 V AC/DC	A = Red B = Red	2	1	3	3SU1802-0NB00-2AB2		1	1 unit
			A = "Without inscription" B = "Without inscription"							
	1	Center command point A = EMERGENCY STOP palm pushbuttons with positive latching function acc. to ISO 13850, pull to unlatch	Red	1	1	3	3SU1801-2NG00-2AA2		1	1 unit







Enclosures

Pushbuttons and indicator lights in the enclosure

Color of enclosure top	Number of command points	Enclosure version Pushbutton and signaling device equipment	Color of actuating element Marking	Number of		SD	Article No.	Price per PU	PU (UNIT, SET, M)	PS*	
				NC contacts	NO contacts						
Enclosures with standard fittings											
Plastic											
 3SU1801-0AB00-2AB1	1	With recess for labeling plate A = Pushbutton	Green	A = I	0	1	3	3SU1801-0AB00-2AB1 3SU1801-0AC00-2AB1 3SU1801-0AD00-2AB1 3SU1801-0AE00-2AB1		1	1 unit
			Red	A = O	1	0	▶				
			White	A = I	0	1	5				
			Black	A = O	1	0	5				
 3SU1802-0AB00-2AB1	2	With recess for labeling plate A = Pushbutton/ B = Pushbutton	A = Red/ B = Green			1	1	3	3SU1802-0AB00-2AB1 3SU1802-0AC00-2AB1	1	1 unit
			A = O/ B = I								
			A = Black/ B = Black			1	1	5			
 3SU1803-0AB00-2AB1	3	With recess for labeling plate A = Pushbutton/ B = Pushbutton/ C = Indicator light	A = Red/ B = Green/ C = Clear			1	1	▶	3SU1803-0AB00-2AB1 3SU1803-0AC00-2AB1 3SU1803-0AD00-2AB1	1	1 unit
			A = O/ B = I/ C = "Without inscription"								
			A = Black/ B = White/ C = Clear			1	1	5			
			A = O/ B = I/ C = "Without inscription"								
 3SU1803-0AB00-2AB1		With recess for labeling plate A = Pushbutton/ B = Pushbutton/ C = Pushbutton	A = Red/ B = Black/ C = Black			1	2	5	3SU1803-0AD00-2AB1	1	1 unit
			A = O/ B = I/ C = II								
 3SU1801-2GA00-2AA1	1	Center command point A = Palm pushbutton, momentary-contact type	Black			0	1	3	3SU1801-2GA00-2AA1	1	1 unit

Enclosures

Pushbuttons and indicator lights in the enclosure

Color of enclosure top	Number of command points	Enclosure version Pushbutton and signaling device equipment	Color of actuating element Marking	Number of		SD	Article No.	Price per PU	PU (UNIT, SET, M)	PS*			
				NC contacts	NO contacts								
Enclosures with standard fittings													
Metal													
	Yellow	1	Center command point A = EMERGENCY STOP mushroom pushbuttons, 40 mm, with positive latching acc. to ISO 13850, rotate to unlatch	Red	1	0	3	3SU1851-0NA00-2AA2 3SU1851-0NB00-2AA2			1	1 unit	
					2	0	5				1	1 unit	
	Yellow	1	With protective collar A = EMERGENCY STOP mushroom pushbuttons, 40 mm, with positive latching acc. to ISO 13850, rotate to unlatch	Red	1	0	▶	3SU1851-0NA00-2AC2 3SU1851-0NB00-2AC2 3SU1851-0ND00-2AC2			1	1 unit	
					2	0	3				1	1 unit	
					2	1	5				1	1 unit	
	Yellow	1	Center command point A = EMERGENCY STOP palm pushbuttons with positive latching acc. to ISO 13850 Pull to unlatch	Red	1	1	3	3SU1851-2NG00-2AA2			1	1 unit	
	Gray	1	With recess for labeling plate A = Pushbutton	Green	A = I	0	1	5	3SU1851-0AB00-2AB1 3SU1851-0AC00-2AB1 3SU1851-0AD00-2AB1 3SU1851-0AE00-2AB1			1	1 unit
				Red	A = O	1	0	5				1	1 unit
				White	A = I	0	1	5				1	1 unit
				Black	A = O	1	0	5				1	1 unit
	Gray	2	With recess for labeling plate A = Pushbutton/ B = Pushbutton	A = Red/ B = Green	A = O/ B = I	1	1	5	3SU1852-0AB00-2AB1 3SU1852-0AC00-2AB1			1	1 unit
				A = Black/ B = White	A = O/ B = I	1	1	5				1	1 unit
	Gray	3	With recess for labeling plate A = Pushbutton/ B = Pushbutton/ C = Indicator light	A = Red/ B = Green/ C = Clear	A = O/ B = I/ C = "Without inscription"	1	1	5	3SU1853-0AB00-2AB1 3SU1853-0AD00-2AB1			1	1 unit
				A = Red/ B = Black/ C = Black	A = O/ B = I/ C = II	1	2	5				1	1 unit
	Gray	1	Center command point A = Palm pushbutton, momentary-contact type	Black		0	1	3	3SU1851-2GA00-2AA1			1	1 unit

Enclosures

Pushbuttons and indicator lights in the enclosure

Number of command points	Product function / EMERGENCY STOP function	DT	Order No.	PU (UNIT, SET, M)	PS*
--------------------------	--	----	-----------	-------------------	-----

Customized enclosures¹⁾



Plastic version

1	No	A	3SU1801-0AZ00 K0Y	1	1 unit
	Yes	A	3SU1801-0NZ00 K0Y	1	1 unit
2	No	A	3SU1802-0AZ00 K0Y	1	1 unit
	Yes	A	3SU1802-0NZ00 K0Y	1	1 unit
3	No	A	3SU1803-0AZ00 K0Y	1	1 unit
	Yes	A	3SU1803-0NZ00 K0Y	1	1 unit
4	No	A	3SU1804-0AZ00 K0Y	1	1 unit
	Yes	A	3SU1804-0NZ00 K0Y	1	1 unit
6	No	A	3SU1806-0AZ00 K0Y	1	1 unit
	Yes	A	3SU1806-0NZ00 K0Y	1	1 unit



Metal version

1	No	A	3SU1851-0AZ00 K0Y	1	1 unit
	Yes	A	3SU1851-0NZ00 K0Y	1	1 unit
2	No	A	3SU1852-0AZ00 K0Y	1	1 unit
	Yes	A	3SU1852-0NZ00 K0Y	1	1 unit
3	No	A	3SU1853-0AZ00K0Y	1	1 unit
	Yes	A	3SU1853-0NZ00 K0Y	1	1 unit
4	No	A	3SU1854-0AZ00 K0Y	1	1 unit
	Yes	A	3SU1854-0NZ00 K0Y	1	1 unit
6	No	A	3SU1856-0AZ00 K0Y	1	1 unit
	Yes	A	3SU1856-0NZ00 K0Y	1	1 unit

¹⁾ The fittings and labeling of the command points can be chosen using the Configurator on the Internet. The prices depend on the equipment selected; see www.siemens.com/sirius-act/configurator.

Enclosures

Pushbuttons and indicator lights in the enclosure for AS-Interface

Overview

With AS-Interface enclosures, distributed SIRIUS ACT pushbuttons and indicator lights can be quickly connected to the AS-Interface communication system. Using suitable components you can assemble your own enclosures with integrated AS-Interface or flexibly modify existing enclosures.



Enclosures for AS-Interface

Enclosures

Color of enclosure top:

- Gray, RAL 7035
- Yellow, RAL 1004, for EMERGENCY STOP

Color of enclosure lower part:

- Black, RAL 9005

Equipping with AS-Interface slaves

The following slaves are available for connecting the command points:

- Slave in A/B technology with 4 digital inputs and 3 digital outputs (4 DI / 3 DO)
- Slave with 4 digital inputs and 4 digital outputs (4 DI / 4 DO)
- F slave with 2 safe inputs for EMERGENCY STOP mushroom pushbutton (2 F-DI), also with LED
- F slave with 2 safe inputs and one digital output (2 F-DI + 1 DO)

The following table shows the maximum number of slaves possible:

Number of command points	Number of slaves for enclosures without EMERGENCY STOP	Number of slaves for enclosures with EMERGENCY STOP
1	--	1 x F slave 2 F-DI
2	1 x slave 4 DI/4 DO or 4 DI/3 DO	--
3	1 x slave 4 DI/4 DO or 4 DI/3 DO	1 x slave 4 DI/4 DO or 4 DI/3 DO + 1 x F slave
4	2 x slave 4 DI/4 DO or 4 DI/3 DO	2 x slave 4 DI/4 DO or 4 DI/3 DO + 1 x F slave
6	2 x slave 4 DI/4 DO or 4 DI/3 DO	2 x slave 4 DI/4 DO or 4 DI/3 DO + 1 x F slave

Connection

One set of links is required in each case to connect a slave to contact modules, LED modules, and the connection element.

The connection elements are mounted in the front-end cable glands and are used to connect the AS-Interface or bring unused inputs or outputs out of the enclosure.

For connection to AS-Interface, the following options are available:

- Terminal for shaped AS-Interface cable. The cable is contacted by the insulation piercing method and routed past the enclosure on the outside (possible only with plastic enclosure).
- Cable gland for the shaped AS-Interface cable or round cable. The cable is routed into the enclosure (preferable for metal enclosure).
- Connection using M12 plug.

If less than all inputs/outputs of the installed slaves in an enclosure are used for connecting the commanding devices, free inputs and outputs can be routed on request to the outside through an M12 socket on the top or bottom side of the enclosure.

To supply inputs with power, the S+ connection of the slave must be assigned to the socket, for outputs the OUT- connection must be assigned. Addressing is performed using the AS-Interface connections or the integrated addressing socket. An external power supply is not required.

Enclosures with standard fittings

Enclosures with standard fittings are available with:

- 1 to 3 command points
- Operational voltage through AS-Interface (approx. 30 V)
- Vertical mounting type
- Plastic enclosures are equipped with plastic actuators and indicators, metal enclosures are equipped with metal actuators and indicators

The enclosures without EMERGENCY STOP each have one module with 4I/3O; the enclosures with EMERGENCY STOP mushroom pushbuttons have a safe AS-Interface slave integrated in the enclosure. Enclosures with EMERGENCY STOP mushroom pushbuttons are fitted with two NC contact modules, which are wired to the safe F slave.

The contact modules and LED modules (with spring-type terminals) of the commanding devices and the AS-Interface slaves are mounted in the base of the enclosure and connected using cables. The plastic enclosures are designed with a connection for the AS-Interface flat cable (the cable is run along the outside of the enclosure). For metal enclosures, the AS-Interface cable is run inside the enclosure.

The enclosures with EMERGENCY STOP mushroom pushbuttons are also available with an M12 connector.

Customized enclosures (selection by configurator)

To order customized 3SU18 AS-Interface enclosures with pushbuttons and indicator lights, use the 3SU1 configurator to select the elements for equipping. An electronic order form will be generated for the options.

Configurator see www.siemens.com/sirius-act/configurator

Enclosures



Pushbuttons and indicator lights in the enclosure for AS-Interface

Selection and ordering data

Color of enclosure top	Number of command points	Enclosure version Command point fittings	Color, marking	DT	Insulation piercing method		PU (UNIT, SET, M)	PS*
Order No.								

Enclosures with standard fittings

Plastic version

	Yellow	1	With recess for labeling plate A = EMERGENCY STOP mushroom push-button 40 mm, with positive latching function according to ISO 13850, Rotate to unlatch	Red	B	3SU1801-0NB10-4HB2	1	1 unit
	Gray	2	With recess for labeling plate A = pushbutton / B = pushbutton	A = red, O B = green, I A = black, O B = white, I	B	3SU1802-0AB10-4HB1 3SU1802-0AC10-4HB1	1	1 unit
		3	With recess for labeling plate A = pushbutton / B = pushbutton / C = indicator light	A = red, O B = green, I C = clear, without inscription	B	3SU1803-0AB10-4HB1	1	1 unit

Number of command points	Emergency stop functionality	DT	Order No.	PU (UNIT, SET, M)	PS*
--------------------------	------------------------------	----	-----------	-------------------	-----

Customer specific enclosures for AS-Interface

Plastic version

	1	No	A	3SU1801-0NZ10 K0Y	1	1 unit
	2	No	A	3SU1802-0AZ10 K0Y	1	1 unit
		Yes	A	3SU1802-0NZ10 K0Y	1	1 unit
	3	No	A	3SU1803-0AZ10 K0Y	1	1 unit
		Yes	A	3SU1803-0NZ10 K0Y	1	1 unit
	4	No	A	3SU1804-0AZ10 K0Y	1	1 unit
		Yes	A	3SU1804-0NZ10 K0Y	1	1 unit
	6	No	A	3SU1806-0AZ10 K0Y	1	1 unit
		Yes	A	3SU1806-0NZ10 K0Y	1	1 unit

Metal version

	1	No	A	3SU1851-0NZ10 K0Y	1	1 unit
	2	No	A	3SU1852-0AZ10 K0Y	1	1 unit
		Yes	A	3SU1852-0NZ10 K0Y	1	1 unit
	3	No	A	3SU1853-0AZ10K0Y	1	1 unit
		Yes	A	3SU1853-0NZ10 K0Y	1	1 unit
	4	No	A	3SU1854-0AZ10 K0Y	1	1 unit
		Yes	A	3SU1854-0NZ10 K0Y	1	1 unit
	6	No	A	3SU1856-0AZ10 K0Y	1	1 unit
		Yes	A	3SU1856-0NZ10 K0Y	1	1 unit

¹⁾ The command points and inscription can be configured online via the SIRIUS ACT configurator, www.siemens.com/sirius-act/configurator

Enclosures

Modules for enclosures

Selection and ordering data

Contact version	Number of		SD	Screw terminals		PU (UNIT, SET, M)	PS*
	NO contacts	NC contacts		Article No.	Price per PU		
Contact modules for base mounting							
	Silver alloy	1	0		▶ 3SU1400-2AA10-1BA0	1	1 unit
		0	1				
3SU1400-2AA10-1BA0	Gold-plated NEW	1	0		▶ 3SU1400-2AA10-1LA0	1	1 unit
		0	1		▶ 3SU1400-2AA10-1MA0	1	1 unit
3SU1400-2AA10-1LA0					Spring-type terminals 		
	Silver alloy	1	0		▶ 3SU1400-2AA10-3BA0	1	1 unit
		0	1		▶ 3SU1400-2AA10-3CA0	1	1 unit
	3SU1400-2AA10-3BA0						
	Gold-plated NEW	1	0		▶ 3SU1400-2AA10-3LA0	1	1 unit
		3SU1400-2AA10-3LA0					

⊖ Positive opening according to IEC 60947-5-1, Annex K.
Can be used with 3SK11 safety relays or the 3RK3 Modular Safety System,
see Section 13.
Certificate:



Enclosures

Modules for enclosures

Operational voltage at AC	Operational voltage at DC	Color	SD	Screw terminals		PU (UNIT, SET, M)	PS*
				Article No.	Price per PU		
LED modules¹⁾ for base mounting							
24	24	Amber	3	3SU1401-2BB00-1AA0		1	1 unit
		Red	3	3SU1401-2BB20-1AA0		1	1 unit
		Yellow	3	3SU1401-2BB30-1AA0		1	1 unit
		Green	3	3SU1401-2BB40-1AA0		1	1 unit
		Blue	▶	3SU1401-2BB50-1AA0		1	1 unit
		White	3	3SU1401-2BB60-1AA0		1	1 unit
110	--	Amber	5	3SU1401-2BC00-1AA0		1	1 unit
		Red	▶	3SU1401-2BC20-1AA0		1	1 unit
		Yellow	5	3SU1401-2BC30-1AA0		1	1 unit
		Green	▶	3SU1401-2BC40-1AA0		1	1 unit
		Blue	▶	3SU1401-2BC50-1AA0		1	1 unit
		White	▶	3SU1401-2BC60-1AA0		1	1 unit
230	--	Amber	5	3SU1401-2BF00-1AA0		1	1 unit
		Red	▶	3SU1401-2BF20-1AA0		1	1 unit
		Yellow	5	3SU1401-2BF30-1AA0		1	1 unit
		Green	▶	3SU1401-2BF40-1AA0		1	1 unit
		Blue	▶	3SU1401-2BF50-1AA0		1	1 unit
		White	▶	3SU1401-2BF60-1AA0		1	1 unit



3SU1401-2BB60-1AA0

¹⁾ Only for use with SIRIUS commanding and signaling devices.

Operational voltage at AC	Operational voltage at DC	Color	SD	Spring-type terminals		PU (UNIT, SET, M)	PS*
				Article No.	Price per PU		
LED modules¹⁾ for base mounting							
24	24	Amber	5	3SU1401-2BB00-3AA0		1	1 unit
		Red	▶	3SU1401-2BB20-3AA0		1	1 unit
		Yellow	5	3SU1401-2BB30-3AA0		1	1 unit
		Green	▶	3SU1401-2BB40-3AA0		1	1 unit
		Blue	▶	3SU1401-2BB50-3AA0		1	1 unit
		White	▶	3SU1401-2BB60-3AA0		1	1 unit
110	--	Amber	5	3SU1401-2BC00-3AA0		1	1 unit
		Red	▶	3SU1401-2BC20-3AA0		1	1 unit
		Yellow	5	3SU1401-2BC30-3AA0		1	1 unit
		Green	▶	3SU1401-2BC40-3AA0		1	1 unit
		Blue	▶	3SU1401-2BC50-3AA0		1	1 unit
		White	▶	3SU1401-2BC60-3AA0		1	1 unit
230	--	Amber	5	3SU1401-2BF00-3AA0		1	1 unit
		Red	▶	3SU1401-2BF20-3AA0		1	1 unit
		Yellow	5	3SU1401-2BF30-3AA0		1	1 unit
		Green	▶	3SU1401-2BF40-3AA0		1	1 unit
		Blue	▶	3SU1401-2BF50-3AA0		1	1 unit
		White	▶	3SU1401-2BF60-3AA0		1	1 unit





3SU1401-2BB20-3AA0

¹⁾ Only for use with SIRIUS commanding and signaling devices.

Enclosures

Modules for enclosures

Operational voltage at AC	Operational voltage at DC	Color	SD	Screw terminals		PU (UNIT, SET, M)	PS*			
				Article No.	Price per PU					
V	V		d							
LED modules¹⁾ for base mounting - wide voltage range										
 3SU1401-2BG60-1AA0	6 ... 24	6 ... 24	Amber	3	3SU1401-2BG00-1AA0		1	1 unit		
			Red	▶	3SU1401-2BG20-1AA0				1	1 unit
			Yellow	5	3SU1401-2BG30-1AA0				1	1 unit
			Green	▶	3SU1401-2BG40-1AA0				1	1 unit
			Blue	▶	3SU1401-2BG50-1AA0				1	1 unit
			White	▶	3SU1401-2BG60-1AA0				1	1 unit
			24 ... 240	24 ... 240	Amber				5	3SU1401-2BH00-1AA0
Red	▶	3SU1401-2BH20-1AA0			1	1 unit				
Yellow	5	3SU1401-2BH30-1AA0			1	1 unit				
Green	▶	3SU1401-2BH40-1AA0			1	1 unit				
Blue	▶	3SU1401-2BH50-1AA0			1	1 unit				
White	▶	3SU1401-2BH60-1AA0			1	1 unit				
Spring-type terminals										
 3SU1401-2BG20-3AA0	6 ... 24	6 ... 24	Amber	5	3SU1401-2BG00-3AA0		1	1 unit		
			Red	▶	3SU1401-2BG20-3AA0				1	1 unit
			Yellow	5	3SU1401-2BG30-3AA0				1	1 unit
			Green	▶	3SU1401-2BG40-3AA0				1	1 unit
			Blue	▶	3SU1401-2BG50-3AA0				1	1 unit
			White	▶	3SU1401-2BG60-3AA0				1	1 unit
			24 ... 240	24 ... 240	Amber				5	3SU1401-2BH00-3AA0
Red	▶	3SU1401-2BH20-3AA0			1	1 unit				
Yellow	5	3SU1401-2BH30-3AA0			1	1 unit				
Green	▶	3SU1401-2BH40-3AA0			1	1 unit				
Blue	▶	3SU1401-2BH50-3AA0			1	1 unit				
White	▶	3SU1401-2BH60-3AA0			1	1 unit				

¹⁾ Only for use with SIRIUS commanding and signaling devices.

Operational voltage at AC	Operational voltage at DC	SD	Screw terminals		PU (UNIT, SET, M)	PS*	
			Article No.	Price per PU			
V	V	d					
LED test modules¹⁾ for base mounting							
 3SU1401-1CK10-1AA0	6 ... 240	6 ... 240	▶	3SU1400-2CK10-1AA0		1	1 unit

¹⁾ Only to be used for SIRIUS ACT LED modules (6 ... 24 V AC/DC, 24 V AC/DC, 24 ... 240 V AC/DC).

Enclosures

Modules for enclosures

Operational voltage	Slave type	Number of digital inputs		Number of digital outputs	SD	Spring-type terminals (push-in)	PU (UNIT, SET, M)	PS*	
		Standard	Safety-related			☐			
						Article No.	Price per PU		
AS-Interface modules, base mounting									
 30 V	4 DI/3 DQ AB	4	0	3	5	3SU1400-2EJ10-6AA0	1	1 unit	
	4 DI/4DQ	4	0	4	▶	3SU1400-2EK10-6AA0	1	1 unit	
	2 F-DI	0	2	0	5	3SU1400-2EA10-6AA0	1	1 unit	
	2 F-DI + 1LED	0	2	1	5	3SU1401-2EE20-6AA0	1	1 unit	
Electronic module for IO-Link, base mounting									
 24 V	Freely programmable (default 6 DI/2 DQ)	0-8	0	0-8	5	3SU1400-2HL10-6AA0	1	1 unit	
Color						SD	Screw terminals	PU (UNIT, SET, M)	PS*
						d	☉		
						Article No.	Price per PU		
Support terminals <i>NEW</i>									
 3SU1400-2DA10-1AA0	Black				3	3SU1400-2DA10-1AA0	1	1 unit	
	Blue				5	3SU1400-2DA50-1AA0	1	1 unit	
	Green/Yellow				3	3SU1400-2DA43-1AA0	1	1 unit	
 3SU1400-2DA50-3AA0	Black				5	3SU1400-2DA10-3AA0	1	1 unit	
	Blue				5	3SU1400-2DA50-3AA0	1	1 unit	
	Green/Yellow				5	3SU1400-2DA43-3AA0	1	1 unit	

Enclosures

Two-hand operation consoles

Overview

Equipment

The two-hand operation consoles are pre-equipped with commanding devices. In the case of plastic enclosures the command points are equipped as standard with actuators and indicators made of plastic, in the case of metal enclosures they are equipped with actuators and indicators made of metal.

The standard equipment comprises:

- 2 black mushroom pushbuttons, Ø 40 mm, 1 NO + 1 NC
- 1 red EMERGENCY STOP mushroom pushbutton according to ISO 13850, Ø 40 mm, with positive latching, 2 NC

The plastic version can be retrofitted with up to 8 customized command points. The surface of the console has premachined breaking points for this purpose.

Application

The two-hand operation consoles are required for use with machines and systems that have hazardous areas, in order to direct both hands of the operator to one position.

The operation consoles are primarily used on presses, stamping machines, printing presses and paper converting machines, in the chemical industry and in the rubber and plastics industries.





The control command is given by pressing the two mushroom pushbuttons on the sides simultaneously (within 0.5 s of each other) and must be maintained for as long as a hazard exists.

For the further processing of control commands, suitable evaluation units are used, e.g. 3SK11 safety relays or the 3RK3 Modular Safety System.

Standards

The two-hand operation consoles comply with the requirements of EN 574.

Selection and ordering data

Version of actuating element Unlatching method	Color of actuating element	Number of NO contacts	Number of NC contacts	DT	Order No.	PU (UNIT, SET, M)	PS*
Enclosures - Two-hand operation consoles							
Plastic enclosures							
None	--	0	0	B	3SU1803-3AA00-1AA1	1	1 unit
A = mushroom pushbutton, pull-to unlatch mechanism B = EMERGENCY STOP mushroom pushbutton, rotate-to-unlatch mechanism C = mushroom pushbutton, pull-to-unlatch mechanism	A = black B = red C = black	2	4	B	3SU1803-3NB00-1AE1	1	1 unit
							
3SU1803-3NB00-1AE1							
Metal enclosures							
None	--	0	0	B	3SU1853-3AA00-0AA1	1	1 unit
A = mushroom pushbutton, pull-to unlatch mechanism B = EMERGENCY STOP mushroom pushbutton, rotate-to-unlatch mechanism C = mushroom pushbutton, pull-to-unlatch mechanism	A = black B = red C = black	2	4	B	3SU1853-3NB00-1AA1	1	1 unit
							
3SU1853-3NB00-1AA1							
							
3SU1853-3NB00-1AD1							
							
3SU1853-3NB00-1AD1							
Accessories							
Stands for two-hand operation console	Metal	Silver		B	3SU1950-0HN10-0AA0	1	1 unit
							
3SU1950-0HN10-0AA0							

Labels

Insert labels

Overview

Labels can be inserted for identification purposes in pushbuttons (clear) and in illuminated pushbuttons with a flat button. These insert labels are made of semi-transparent plastic with black inscription; they can be fitted in any 90° angle.



Inscription

The inscription is in upper/lower case, all words begin with upper case letters. Graphic symbols, including those not listed in the catalog, are according to ISO 7000 or IEC 60417.

The insert labels without inscription are suitable for user marking with permanent pen.

For customized inscription, see "Options" on page 10/132.

Selection and ordering data

Color	Marking	DT	Order No.	PU (UNIT, SET, M)	PS*
Insert labels					
For self-inscription					
	Clear/Black (label/lettering)	None	B	3SU1900-0AB71-0AA0	100 10 units
	For customized inscription				
	Clear/Black (label/lettering)	None	B	3SU1900-0AB71-0AZ0	100 10 units
	Inscription in English				
	Clear/Black (label/lettering)	On	B	3SU1900-0AB71-0DJ0	100 10 units
		Off	B	3SU1900-0AB71-0DK0	100 10 units
		Up	B	3SU1900-0AB71-0DL0	100 10 units
		Down	B	3SU1900-0AB71-0DM0	100 10 units
		Forward+	B	3SU1900-0AB71-0DN0	100 10 units
		Right	B	3SU1900-0AB71-0DQ0	100 10 units
		Left	B	3SU1900-0AB71-0DR0	100 10 units
		Stop	B	3SU1900-0AB71-0DS0	100 10 units
		Start	B	3SU1900-0AB71-0DT0	100 10 units
		Reset	B	3SU1900-0AB71-0DU0	100 10 units
		Test	B	3SU1900-0AB71-0DV0	100 10 units
		Open	B	3SU1900-0AB71-0DW0	100 10 units
		Close	B	3SU1900-0AB71-0DX0	100 10 units
		Running	B	3SU1900-0AB71-0EB0	100 10 units
		Fast	B	3SU1900-0AB71-0EE0	100 10 units
		Slow	B	3SU1900-0AB71-0EF0	100 10 units

3SU1900-0AB71-0AA0

3SU1900-0AB71-0DN0

Labels

Insert labels

Color	Marking	Symbol No.	SD	Article No.	Price per PU	PU (UNIT, SET, M)	PS*
-------	---------	------------	----	-------------	--------------	-------------------	-----

Insert labels

With symbol (ON/OFF)



3SU1900-0AB71-0QCO

Milky white/ black (label/lettering)	O	5008 IEC	▶	3SU1900-0AB71-0QA0		100	10 units
	I	5007 IEC	▶	3SU1900-0AB71-0QB0		100	10 units
	II	--	5	3SU1900-0AB71-0QC0		100	10 units
	III	--	5	3SU1900-0AB71-0QD0		100	10 units

With symbol (graphic)

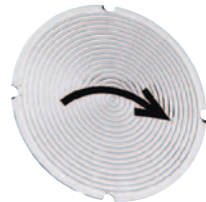

3SU1900-0AB71-0QT0

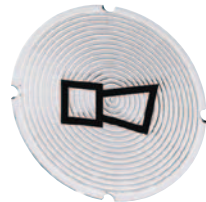

3SU1900-0AB71-0RB0



3SU1900-0AB71-0RNO

Milky white/ black (label/lettering)	→	ARROW DIRECTION TO RIGHT	5022 IEC	▶	3SU1900-0AB71-0QR0	100	10 units
	↖	ARROW DIRECTION UP AND TO LEFT	--	▶	3SU1900-0AB71-0QS0	100	10 units
	↻	CLOCKWISE ROTATION	0004 ISO	5	3SU1900-0AB71-0QT0	100	10 units
	↺	COUNTERCLOCK- WISE ROTATION	--	5	3SU1900-0AB71-0QU0	100	10 units
	⚡	RAPID TRAVERSE	0266 ISO	5	3SU1900-0AB71-0QV0	100	10 units
	⚡	FEED	0259 ISO	5	3SU1900-0AB71-0QW0	100	10 units
	+	INCREASE, PLUS	5005 IEC	5	3SU1900-0AB71-0QX0	100	10 units
	-	DECREASE, MINUS	5006 IEC	5	3SU1900-0AB71-0QY0	100	10 units
	⚙	ELECTRIC MOTOR	0011 ISO	5	3SU1900-0AB71-0RA0	100	10 units
	📢	HORN	5014 IEC	5	3SU1900-0AB71-0RB0	100	10 units
	⚙	WATER INLET	--	5	3SU1900-0AB71-0RC0	100	10 units
	⚙	PUMP	0134 ISO	5	3SU1900-0AB71-0RD0	100	10 units
	⚙	COOLANT PUMP	0355 ISO	5	3SU1900-0AB71-0RE0	100	10 units
	🔩	LOCK, TIGHTEN	5653 IEC	5	3SU1900-0AB71-0RF0	100	10 units
	🔩	UNLOCK, UNCLAMP	5652 IEC	5	3SU1900-0AB71-0RG0	100	10 units
	🛑	BRAKE	--	5	3SU1900-0AB71-0RH0	100	10 units
	🛑	RELEASE BRAKE	0021 ISO	5	3SU1900-0AB71-0RJ0	100	10 units
	🔒	INTERLOCK	0022 ISO	5	3SU1900-0AB71-0RK0	100	10 units
	🔒	UNLOCK	0023 ISO	5	3SU1900-0AB71-0RL0	100	10 units
	⚙	SET UP	0910 ISO	5	3SU1900-0AB71-0RM0	100	10 units
⊕	ON/OFF, MOMENTARY CONTACT TYPE	5011 IEC	5	3SU1900-0AB71-0RNO	100	10 units	
👤	MANUAL OPERATION	0096 ISO	5	3SU1900-0AB71-0RP0	100	10 units	
🔄	AUTOMATIC CYCLE	0017 ISO	▶	3SU1900-0AB71-0RQ0	100	10 units	
🌬	SUCTION	--	5	3SU1900-0AB71-0RR0	100	10 units	
🌬	BLOWING	--	5	3SU1900-0AB71-0RS0	100	10 units	

Labels

Insert labels

Options

Customized inscriptions

The labels can be inscribed with text and symbols not listed in the ordering data.

By default, a letter height of 4 mm (for a single line of text) or 3 mm (for two or three lines of text) is used for text inscriptions.

The typeface used is Arial. Other letter heights and typefaces are possible, but must be specified when ordering.

For round insert labels, the maximum possible number of characters per line is:

- 10 characters for one line of text
- 8 characters for 2 lines of text
- 6 characters for 3 lines of text, but 10 characters in the middle line

Examples for customized inscription



Two-line inscription in upper/lower case lettering (Q0Y)



Single-line inscription in upper case lettering (Q1Y)



Three-line inscription in lower case letters (Q2Y)

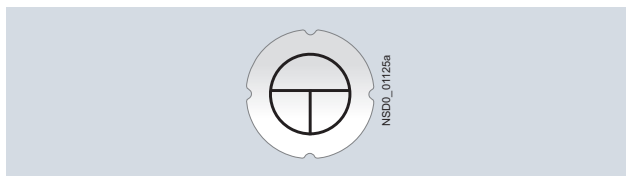

Symbol number 5011 according to IEC 60417 (Q3Y)

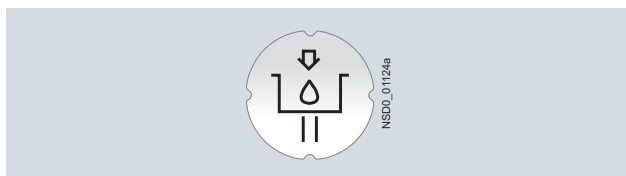

Any symbol according to order form supplement (Q9Y)

Ordering notes

Append the following order codes to the Order No.:

- Text line(s) in upper/lower case, upper case always for beginning of line (e.g. "Lift / Off"): **Q0Y**
- Text line(s) in upper case (e.g. "LIFT"): **Q1Y**
- Text line(s) in lower case (e.g. "lift / off / lower"): **Q2Y**
- Text line(s) in upper/lower case, all words begin with upper case letters (e.g. "On Off"): **Q5Y**
- Symbol with number according to ISO 7000 or IEC 60417: **Q3Y**
- Any inscription or symbol according to order form supplement: **Q9Y**

When ordering, specify the required inscription in plain text in addition to the article number and order code. In the case of special inscriptions with words in languages other than German, give the exact spelling and specify the language. In the case of multi-line inscriptions, the text must be assigned to the respective line, e.g. "Z1 = Lift, Z2 =Lower". For long words you can also specify the end-of-line division; see [ordering example 1](#)

Symbols can also be ordered with numbers according to ISO 7000 or IEC 60417; see [ordering examples 2 and 3](#)

The SIRIUS ACT Configurator must be used to select customized inscriptions and symbols (order code Q9Y). In this case a "CIN" (Configuration Identification Number) is generated for placement of future orders. It is then possible to place an order directly using the CIN and the SIRIUS ACT Configurator (Mall shopping cart) or via the standard order channels.

Standard ordering channels:

- Configurator: www.siemens.com/sirius-act/configurator
- Electronic Catalog CA 01 on DVD
- Industry Mall: www.usa.siemens.com/industrymall

Ordering example 1

A label with 2 lines of text is required:

3SU1900-0AB71-0AZ0
Q1Y
Z1 = LIFT
Z2 = LOWER

Ordering example 2

A label inscribed with symbol No. 5011 according to IEC 60417 is required:

3SU1900-0AB71-0AZ0
Q3Y
Z = 5011 IEC

Ordering example 3



A label inscribed with symbol No. 1118 according to ISO 7000 is required:

3SU1900-0AB71-0AZ0
Q3Y
Z = 1118 ISO

Labels

Label holders for labeling plates

Selection and ordering data

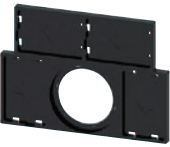
Label holder shape	Label holder color	Label fastening method	Labeling plate size		SD	Article No.	Price per PU	PU (UNIT, SET, M)	PS*	
			Height mm	Width mm						
Label holders for labeling plates										
	With rounded bottom	Black	Self-adhesive	12.5	27	▶	3SU1900-0AG10-0AA0	100	10 units	
				17.5	27	▶	3SU1900-0AH10-0AA0	100	10 units	
				27	27	▶	3SU1900-0AJ10-0AA0	100	10 units	
	Snap-on	12.5	27	▶	3SU1900-0AR10-0AA0	100	10 units			
		17.5	27	▶	3SU1900-0AS10-0AA0	100	10 units			
		27	27	▶	3SU1900-0AT10-0AA0	100	10 units			
3SU1900-0AG10-0AA0										
	With square bottom	Black	Self-adhesive	12.5	27	3	3SU1900-0AN10-0AA0	100	10 units	
				17.5	27	▶	3SU1900-0AP10-0AA0	100	10 units	
				27	27	5	3SU1900-0AQ10-0AA0	100	10 units	
3SU1900-0AN10-0AA0										
Label holders for labeling plates, coordinate switches										
	With square bottom	Black	Self-adhesive	27	27	▶	3SU1900-0AL10-0AA0		1	1 unit
									3SU1900-0AL10-0AA0	
	Cross	Black	Self-adhesive	27	27	▶	3SU1900-0AM10-0AA0		1	1 unit
									3SU1900-0AM10-0AA0	
Label holders for labeling plates, twin pushbuttons										
	Rectangular	Black	Self-adhesive	12.5	27	▶	3SU1900-0AK10-0AA0		100	10 units
									3SU1900-0AK10-0AA0	
Single frames										
	Square	--	--	29.8	29.8	▶	3SU1900-0AX10-0AA0		1	10 units
									3SU1900-0AX10-0AA0	
Label holders for labeling plates 17.5 x 27 mm NEW										
	For 2 labeling plates	Black	Self-adhesive	17.5	27	▶	3SU1900-0BQ10-0AA0		1	1 unit
			Snap-on						▶	3SU1900-0BR10-0AA0
	For 4 labeling plates	Black	Self-adhesive	▶	3SU1900-0BS10-0AA0		1	1 unit		
			Snap-on				▶	3SU1900-0BT10-0AA0	1	1 unit
3SU1900-0BT10-0AA0										

Labels

Labeling plates

Overview

The backing plates consist of a black molded-plastic label holder and a labeling plate (black with white print or silver-colored with black print) for sticking or snapping in place. They are not suitable for EMERGENCY STOP buttons. Note mounting dimensions!

Inscription

The inscription is in upper/lower case, all words begin with upper case letters. Graphic symbols, including those not listed in the catalog, are according to ISO 7000 or IEC 60417.

For customized inscription, see "Options" on page 10/139.





Labeling plates for sticking/snapping in place

The labels are available in three sizes:

- 12.5 mm × 27 mm
- 17.5 mm × 27 mm
- 27 mm × 27 mm





For mounting the labeling plates, you can choose between label holders for stick-on or snap-on mounting.

Selection and ordering data

Color	Marking	Symbol No.	DT	Order No.	PU (UNIT, SET, M)	PS*
Labeling plates 12.5 mm x 27 mm						
For self-inscription						
	Black/White (label/lettering)	None	--	▶ 3SU1900-0AC16-0AA0	100	10 units
	For custom inscription					
	Black/White (label/lettering)	None	--	▶ 3SU1900-0AB71-0AZ0	100	10 units
	Inscription in English					
	Black/White (label/lettering)	On	--	B 3SU1900-0AC16-0DJ0	100	10 units
		Off	--	B 3SU1900-0AC16-0DK0	100	10 units
		Up	--	B 3SU1900-0AC16-0DL0	100	10 units
		Down	--	B 3SU1900-0AC16-0DM0	100	10 units
		Forward	--	▶ 3SU1900-0AC16-0DN0	100	10 units
		Reverse	--	B 3SU1900-0AC16-0DP0	100	10 units
		Right	--	B 3SU1900-0AC16-0DQ0	100	10 units
		Left	--	B 3SU1900-0AC16-0DR0	100	10 units
		Stop	--	▶ 3SU1900-0AC16-0DS0	100	10 units
		Start	--	▶ 3SU1900-0AC16-0DT0	100	10 units
		Reset	--	B 3SU1900-0AC16-0DU0	100	10 units
		Test	--	B 3SU1900-0AC16-0DV0	100	10 units
		Open	--	▶ 3SU1900-0AC16-0DW0	100	10 units
		Close	--	▶ 3SU1900-0AC16-0DX0	100	10 units
		Jog	--	B 3SU1900-0AC16-0DE0	100	10 units
		Running	--	B 3SU1900-0AC16-0EB0	100	10 units
		Fault	--	B 3SU1900-0AC16-0EC0	100	10 units
		Run	--	B 3SU1900-0AC16-0ED0	100	10 units
		Stop Start	--	B 3SU1900-0AC16-0DC0	100	10 units
		Off On	--	▶ 3SU1900-0AC16-0DH0	100	10 units
	Power off	--	B 3SU1900-0AC16-0DF0	100	10 units	
	Power on	--	B 3SU1900-0AC16-0DG0	100	10 units	
	Man O Auto	--	B 3SU1900-0AC16-0DY0	100	10 units	
	Man Auto	--	B 3SU1900-0AC16-0EA0	100	10 units	
	Hand Auto	--	B 3SU1900-0AC16-0DB0	100	10 units	
	Hand O Auto	--	B 3SU1900-0AC16-0DD0	100	10 units	
With symbol						
	Black/White (label/lettering)	O	--	B 3SU1900-0AC16-0QA0	100	10 units
		I	--	B 3SU1900-0AC16-0QB0	100	10 units
		O I	--	B 3SU1900-0AC16-0QG0	100	10 units
		1 2	--	B 3SU1900-0AC16-0QJ0	100	10 units
		↑	ARROW DIRECTION UP	--	B 3SU1900-0AC16-0QS0	100

Labels

Labeling plates

Color	Marking	Symbol No.	DT	Order No.	PU (UNIT, SET, M)	PS*
Labeling plates 12.5 mm x 27 mm						
For self-inscription						
	Silver/Black (label/lettering)	None	A	3SU1900-0AC81-0AA0	100	10 units
	For custom inscription					
	Silver/Black (label/lettering)	None	A	3SU1900-0AC81-0AZ0	100	10 units
	Inscription in English					
	Silver/Black (label/lettering)	On	--	B	3SU1900-0AC81-0DJ0	100 10 units
		Off	--	B	3SU1900-0AC81-0DK0	100 10 units
		Up	--	B	3SU1900-0AC81-0DL0	100 10 units
		Down	--	B	3SU1900-0AC81-0DM0	100 10 units
		Stop	--	B	3SU1900-0AC81-0DS0	100 10 units
		Start	--	B	3SU1900-0AC81-0DT0	100 10 units
		Reset	--	B	3SU1900-0AC81-0DU0	100 10 units
		Test	--	B	3SU1900-0AC81-0DV0	100 10 units
		Open	--	B	3SU1900-0AC81-0DW0	100 10 units
		Close	--	B	3SU1900-0AC81-0DX0	100 10 units
		Man O Auto	--	B	3SU1900-0AC81-0DY0	100 10 units
		Man Auto	--	B	3SU1900-0AC81-0EA0	100 10 units
		Running	--	B	3SU1900-0AC81-0EB0	100 10 units
		Fault	--	B	3SU1900-0AC81-0EC0	100 10 units
		Fast	--	B	3SU1900-0AC81-0EE0	100 10 units
		Slow	--	B	3SU1900-0AC81-0EF0	100 10 units
		Hand Auto	--	B	3SU1900-0AC81-0DB0	100 10 units
		Stop Start	--	B	3SU1900-0AC81-0DC0	100 10 units
	Hand O Auto	--	B	3SU1900-0AC81-0DD0	100 10 units	
With symbol						
	Silver/Black (label/lettering)	O	5008 IEC	B	3SU1900-0AC81-0QA0	100 10 units
		I	5007 IEC	B	3SU1900-0AC81-0QB0	100 10 units
		II	--	B	3SU1900-0AC81-0QC0	100 10 units
		III	--	B	3SU1900-0AC81-0QD0	100 10 units
		O I	--	B	3SU1900-0AC81-0QG0	100 10 units
		I O II	--	B	3SU1900-0AC81-0QK0	100 10 units
		1 O 2	--	B	3SU1900-0AC81-0QL0	100 10 units
		→ ARROW DIRECTION TO RIGHT	5022 IEC	B	3SU1900-0AC81-0QR0	100 10 units
		↑ ARROW DIRECTION UP	--	B	3SU1900-0AC81-0QS0	100 10 units



Labels

Labeling plates

Color	Marking	Symbol No.	DT	Order No.	PU (UNIT, SET, M)	PS*	
Labeling plates 17.5 mm x 27 mm							
For self-inscription							
	Black/White (label/lettering)	None	--	▶ 3SU1900-0AD16-0AA0	100	10 units	
	For custom inscription						
	Black/White (label/lettering)	None	--	▶ 3SU1900-0AD16-0AZ0	100	10 units	
Inscription in English							
	Black/White (label/lettering)	Stop Start	--	B 3SU1900-0AD16-0DC0	100	10 units	
		On	--	B 3SU1900-0AD16-0DJ0	100	10 units	
		Off	--	B 3SU1900-0AD16-0DK0	100	10 units	
		Up	--	B 3SU1900-0AD16-0DL0	100	10 units	
		Down	--	B 3SU1900-0AD16-0DM0	100	10 units	
		Forward	--	B 3SU1900-0AD16-0DN0	100	10 units	
		Reverse	--	B 3SU1900-0AD16-0DP0	100	10 units	
		Right	--	B 3SU1900-0AD16-0DQ0	100	10 units	
		Stop	--	B 3SU1900-0AD16-0DS0	100	10 units	
		Start	--	B 3SU1900-0AD16-0DT0	100	10 units	
		Open	--	B 3SU1900-0AD16-0DW0	100	10 units	
		Close	--	B 3SU1900-0AD16-0DX0	100	10 units	
		Man Auto	--	B 3SU1900-0AD16-0EA0	100	10 units	
		Running	--	B 3SU1900-0AD16-0EB0	100	10 units	
	Fault	--	B 3SU1900-0AD16-0EC0	100	10 units		
	Hand Auto	--	B 3SU1900-0AD16-0DB0	100	10 units		
With symbol							
	Black/White (label/lettering)	O	5008 IEC	B 3SU1900-0AD16-0QA0	100	10 units	
		I	5007 IEC	B 3SU1900-0AD16-0QB0	100	10 units	
		O I	--	B 3SU1900-0AD16-0QG0	100	10 units	
		→	ARROW DIRECTION TO RIGHT	5022 IEC	B 3SU1900-0AD16-0QR0	100	10 units
		↑	ARROW DIRECTION UP	--	B 3SU1900-0AD16-0QS0	100	10 units







Labels

Labeling plates

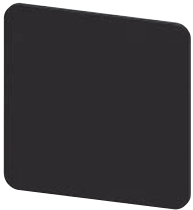
Color	Marking	Symbol No.	DT	Order No.	PU (UNIT, SET, M)	PS*	
Labeling plates 17.5 mm x 27 mm							
For self-inscription							
	Silver/Black (label/lettering)	None	--	A	3SU1900-0AD81-0AA0	100 10 units	
	For custom inscription						
	Silver/Black (label/lettering)	None	--	A	3SU1900-0AD81-0AZ0	100 10 units	
Inscription in English							
	Silver/Black (label/lettering)	On	--	B	3SU1900-0AD81-0DJ0	100 10 units	
		Off	--	B	3SU1900-0AD81-0DK0	100 10 units	
		Stop	--	B	3SU1900-0AD81-0DS0	100 10 units	
		Start	--	B	3SU1900-0AD81-0DT0	100 10 units	
		Reset	--	B	3SU1900-0AD81-0DU0	100 10 units	
		Man O Auto	--	B	3SU1900-0AD81-0DY0	100 10 units	
		Fault	--	B	3SU1900-0AD81-0EC0	100 10 units	
		Hand Auto	--	B	3SU1900-0AD81-0DB0	100 10 units	
		Hand O Auto	--	B	3SU1900-0AD81-0DD0	100 10 units	
With symbol							
	Silver/Black (label/lettering)	O	5008 IEC	B	3SU1900-0AD81-0QA0	100 10 units	
		I	5007 IEC	B	3SU1900-0AD81-0QB0	100 10 units	
		O I	--	B	3SU1900-0AD81-0QG0	100 10 units	
		I O II	--	B	3SU1900-0AD81-0QK0	100 10 units	
		I O 2	--	B	3SU1900-0AD81-0QL0	100 10 units	
		→	ARROW DIRECTION TO RIGHT	5022 IEC	B	3SU1900-0AD81-0QR0	100 10 units
		↑	ARROW DIRECTION UP	--	B	3SU1900-0AD81-0QS0	100 10 units
	3SU1900-0AD81-0AA0						
	3SU1900-0AD81-0EC0						
	3SU1900-0AD81-0QG0						

Labels

Labeling plates

Color	Marking	Symbol No.	DT	Order No.	PU (UNIT, SET, M)	PS*	
Labeling plates 27 mm x 27 mm							
	For self-inscription						
	Black/White (label/lettering)	None	--	▶	3SU1900-0AE16-0AA0	100	10 units
	For custom inscription						
	Black/White (label/lettering)	None	--	▶	3SU1900-0AE16-0AZ0	100	10 units
<hr/>							
	For self-inscription			A	3SU1900-0AE81-0AA0	100	10 units
	Silver/Black (label/lettering)						
	For custom inscription			A	3SU1900-0AE81-0AZ0	100	10 units
	Silver/Black (label/lettering)		--				
<hr/>							
Inscription in English							
	Black/White (label/lettering)	On	--	B	3SU1900-0AE16-0DJ0	100	10 units
		Off	--	B	3SU1900-0AE16-0DK0	100	10 units
		Up	--	B	3SU1900-0AE16-0DL0	100	10 units
		Down	--	B	3SU1900-0AE16-0DM0	100	10 units
		Forward	--	B	3SU1900-0AE16-0DN0	100	10 units
		Reverse	--	B	3SU1900-0AE16-0DP0	100	10 units
		Stop	--	B	3SU1900-0AE16-0DS0	100	10 units
		Start	--	B	3SU1900-0AE16-0DT0	100	10 units
		EMERGENCY STOP	--	B	3SU1900-0AE16-0DA0	100	10 units
		Stop Start	--	B	3SU1900-0AE16-0DC0	100	10 units
		Hand Auto	--	B	3SU1900-0AE16-0DB0	100	10 units
<hr/>							
With symbol							
	Black/White (label/lettering)	O I	--	B	3SU1900-0AE16-0QG0	100	10 units
		→ ARROW DIRECTION TO RIGHT	5022 IEC	B	3SU1900-0AE16-0QR0	100	10 units

Labels

Labeling plates

Options

Customized inscriptions

The labels can be inscribed with text and symbols not listed in the ordering data.

The following letter heights are used as standard for text inscriptions:

- Label size 12.5 mm × 27 mm: 3 lines with letter height 4 mm (1-line), 3.5 mm (2-line) or 2.5 mm (3-line)
- Label size 17.5 mm × 27 mm: 3 lines with letter height 4 mm (1- to 2-line) or 3 mm (3-line)
- Label size 27 mm × 27 mm: 5 lines with letter height 4 mm (1- to 5-line)

Up to 11 characters per line are possible. The typeface used is Arial. Other letter heights and typefaces are possible, but must be specified when ordering.

Examples for customized inscription

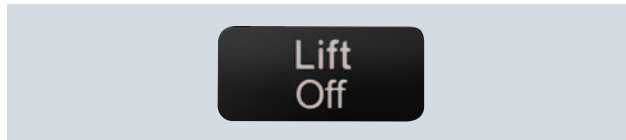

Two-line inscription in upper/lower case lettering (Q0Y)

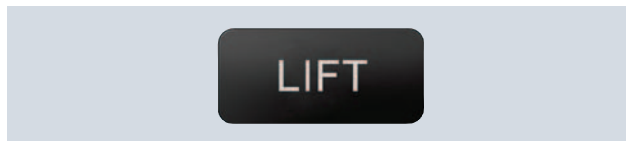

Single-line inscription in upper case lettering (Q1Y)

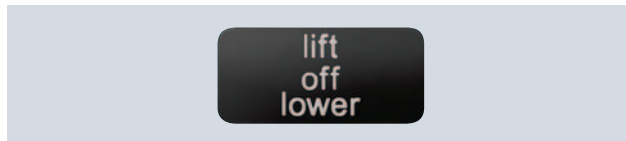

Three-line inscription in lower case letters (Q2Y)



Symbol number 5011 according to IEC 60417 (Q3Y)



Any symbol according to order form supplement (Q9Y)

Ordering notes

Append the following order codes to the Order No.:

- Text line(s) in upper/lower case, upper case always for beginning of line (e.g. "Lift / Off"): **Q0Y**
- Text line(s) in upper case (e.g. "LIFT"): **Q1Y**
- Text line(s) in lower case (e.g. "lift / off / lower"): **Q2Y**
- Text line(s) in upper/lower case, all words begin with upper case letters (e.g. "On Off"): **Q5Y**
- Symbol with number according to ISO 7000 or IEC 60417: **Q3Y**
- Any inscription or symbol according to order form supplement: **Q9Y**

When ordering, specify the required inscription in plain text in addition to the article number and order code. In the case of special inscriptions with words in languages other than German, give the exact spelling and specify the language.

In the case of multi-line inscriptions, the text must be assigned to the respective line, e.g. "Z1 = Lift, Z2 =Lower".

For long words you can also specify the end-of-line division; see [ordering example 1](#)

Symbols can also be ordered with numbers according to ISO 7000 or IEC 60417; see [ordering examples 2 and 3](#)

For special symbols (order code Q9Y), a CAD drawing in BMP, GIF, JPEG, PDF, PNG or TIFF format must be submitted. For special inscriptions (order code Q9Y): document in DOC or XLS format.

The SIRIUS ACT Configurator must be used to select special inscriptions and symbols (order code Q9Y). In this case a "CIN" (Configuration Identification Number) is generated for placement of future orders. It is then possible to place an order directly using the CIN and the SIRIUS ACT Configurator (Mall shopping cart) or via the standard order channels.

Standard ordering channels:

- Configurator: www.siemens.com/sirius-act/configurator
- Electronic Catalog CA 01 on DVD
- Industry Mall: www.usa.siemens.com/industrymall

Ordering example 1

A label with 2 lines of text is required:

3SU1900-0AC16-0AZ0

Q1Y

Z1 = LIFT

Z2 = LOWER

Ordering example 2

A label inscribed with symbol No. 5011 according to IEC 60417 is required:

3SU1900-0AC16-0AZ0

Q3Y

Z = 5011 IEC

Ordering example 3

A label inscribed with symbol No. 1118 according to ISO 7000 is required:

3SU1900-0AC16-0AZ0

Q3Y

Z = 1118 ISO

Labels

Labeling plates for enclosures

Overview

The labeling plates in size 22 mm x 22 mm can be attached to enclosures with cutouts for labels. There are versions in black with white print or silver-colored with black print.

Inscription

The inscription is in upper/lower case, all words begin with upper case letters. Graphic symbols, including those not listed in the catalog, are according to ISO 7000 or IEC 60417.

For customized inscription, see "Options" on page 10/142.

Selection and ordering data

Color	Marking	Symbol No.	DT	Order No.	PU (UNIT, SET, M)	PS*
Labeling plates 22 mm x 22 mm						
For self-inscription						
	Black/White (label/lettering)	None	--	▶ 3SU1900-0AF16-0AA0	100	10 units
	Black/White (label/lettering)	None	--	▶ 3SU1900-0AF16-0AZ0	100	10 units
Inscription in English						
	Black/White (label/lettering)	On	--	B 3SU1900-0AF16-0DJ0	1	10 units
		Off	--	B 3SU1900-0AF16-0DK0	1	10 units
		Up	--	▶ 3SU1900-0AF16-0DL0	1	10 units
		Down	--	▶ 3SU1900-0AF16-0DM0	1	10 units
		Forward	--	B 3SU1900-0AF16-0DN0	1	10 units
		Right	--	B 3SU1900-0AF16-0DQ0	1	10 units
		Left	--	B 3SU1900-0AF16-0DR0	1	10 units
		Stop	--	▶ 3SU1900-0AF16-0DS0	1	10 units
		Start	--	▶ 3SU1900-0AF16-0DT0	1	10 units
		Reset	--	B 3SU1900-0AF16-0DU0	1	10 units
		Test	--	▶ 3SU1900-0AF16-0DV0	1	10 units
		Open	--	B 3SU1900-0AF16-0DW0	1	10 units
		Close	--	B 3SU1900-0AF16-0DX0	1	10 units
		Running	--	B 3SU1900-0AF16-0EB0	1	10 units
	Black/White (label/lettering)	Fault	--	B 3SU1900-0AF16-0EC0	1	10 units
		Fast	--	B 3SU1900-0AF16-0EE0	1	10 units
		Slow	--	B 3SU1900-0AF16-0EF0	1	10 units
		EMERGENCY STOP	--	▶ 3SU1900-0AF16-0DA0	1	10 units
With symbol (ON/OFF)						
	Black/White (label/lettering)	O	5008 IEC	▶ 3SU1900-0AF16-0QA0	1	10 units
		I	5007 IEC	▶ 3SU1900-0AF16-0QB0	1	10 units
		II	--	▶ 3SU1900-0AF16-0QC0	1	10 units
		III	--	B 3SU1900-0AF16-0QD0	1	10 units
		O I	--	B 3SU1900-0AF16-0QG0	1	10 units
		I O II	--	B 3SU1900-0AF16-0QK0	1	10 units
		I O	--	B 3SU1900-0AF16-0QP0	1	10 units
		(one below the other)				
		II O I	--	B 3SU1900-0AF16-0QQ0	1	10 units
		(one below the other)				
With symbol (graphic)						
	Black/White (label/lettering)	→ ARROW DIRECTION TO RIGHT	5022 IEC	▶ 3SU1900-0AF16-0QR0	1	10 units
		☪ PUMP	0134 ISO	B 3SU1900-0AF16-0RD0	1	10 units
		☪ FAN	--	B 3SU1900-0AF16-0RV0	1	10 units
		☪ COOLING	--	B 3SU1900-0AF16-0RW0	1	10 units
		☪ ILLUMINATION	--	B 3SU1900-0AF16-0RX0	1	10 units
		☪ MOTOR	--	B 3SU1900-0AF16-0RY0	1	10 units

Labels

Labeling plates for enclosures

Color	Marking	Symbol No.	DT	Order No.	PU (UNIT, SET, M)	PS*
Labeling plates 22 mm x 22 mm						
For self-inscription						
	Silver/Black (label/lettering)	None	--	A	3SU1900-0AF81-0AA0	100 10 units
	For custom inscription					
	Silver/Black (label/lettering)	None	--	A	3SU1900-0AF81-0AZ0	100 10 units
Inscription in English						
	Silver/Black (label/lettering)	Stop	--	B	3SU1900-0AF81-0DS0	1 10 units
		Start	--	B	3SU1900-0AF81-0DT0	1 10 units
		Reset	--	B	3SU1900-0AF81-0DU0	1 10 units
		Test	--	B	3SU1900-0AF81-0DV0	1 10 units
		Open	--	B	3SU1900-0AF81-0DW0	1 10 units
		Hand O Auto	--	B	3SU1900-0AF81-0DD0	1 10 units
With symbol (ON/OFF)						
	Silver/Black (label/lettering)	O	5008 IEC	B	3SU1900-0AF81-0QA0	1 10 units
		I	5007 IEC	B	3SU1900-0AF81-0QB0	1 10 units
		II	--	B	3SU1900-0AF81-0QC0	1 10 units
		III	--	B	3SU1900-0AF81-0QD0	1 10 units
		O I	--	B	3SU1900-0AF81-0QG0	1 10 units
		I O II	--	B	3SU1900-0AF81-0QK0	1 10 units
		I O (one below the other)	--	B	3SU1900-0AF81-0QP0	1 10 units
		II O I (one below the other)	--	B	3SU1900-0AF81-0QQ0	1 10 units
With symbol (graphic)						
	Silver/Black (label/lettering)	→ ARROW DIRECTION TO RIGHT	5022 IEC	B	3SU1900-0AF81-0QR0	1 10 units

Options

Customized inscriptions

The labels can be inscribed with texts and symbols not listed in the ordering data.

A letter height of 4 mm is used for text inscriptions (1 to 3 lines).

Up to 11 characters per line are possible. The typeface used is Arial. Other letter heights and typefaces are possible, but must be specified when ordering.

Examples for customized inscription

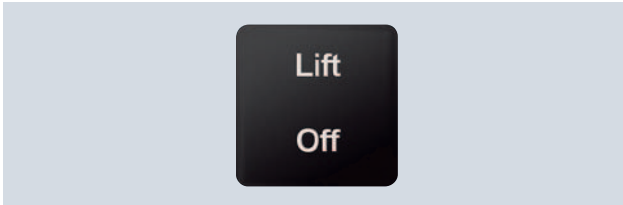

Two-line inscription in upper/lower case lettering (Q0Y)

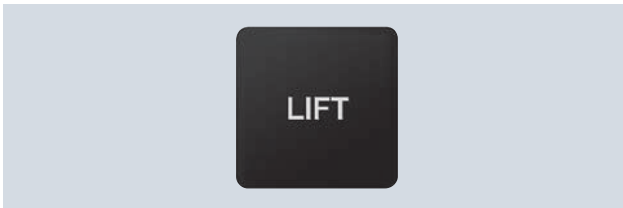

Single-line inscription in upper case lettering (Q1Y)

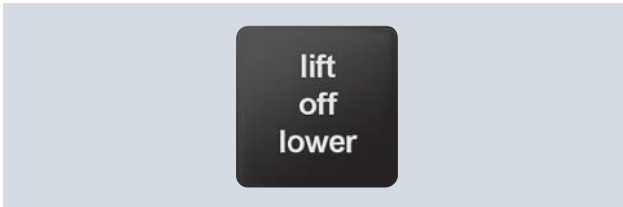

3SB39 backing plate for enclosures, customized inscription (Q2Y)

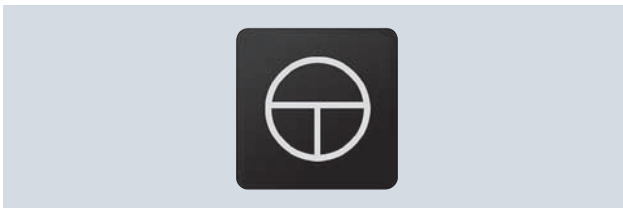

Symbol number 5011 according to IEC 60417 (Q3Y)

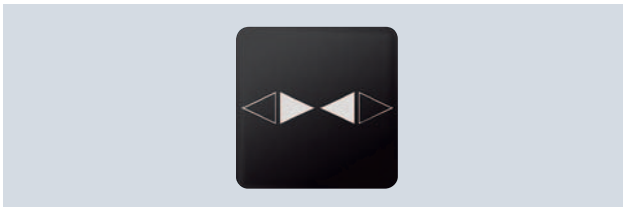

Any symbol according to order form supplement (Q9Y)

Ordering notes

Append the following order codes to the Order No.:

- Text line(s) in upper/lower case, upper case always for beginning of line (e.g. "Lift / Off"): **Q0Y**
- Text line(s) in upper case (e.g. "LIFT"): **Q1Y**
- Text line(s) in lower case (e.g. "lift / off / lower"): **Q2Y**
- Text line(s) in upper/lower case, all words begin with upper case letters (e.g. "On Off"): **Q5Y**
- Symbol with number according to ISO 7000 or IEC 60417: **Q3Y**
- Any inscription or symbol according to order form supplement: **Q9Y**

When ordering, specify the required inscription in plain text in addition to the article number and order code. In the case of special inscriptions with words in languages other than German, give the exact spelling and specify the language.

In the case of multi-line inscriptions, the text must be assigned to the respective line, e.g. "Z1 = Lift, Z2 =Lower". For long words you can also specify the end-of-line division (see ordering example 1).

Symbols can also be ordered with numbers according to ISO 7000 or IEC 60417 (see ordering examples 2 and 3).

For special symbols (order code Q9Y), a CAD drawing in DXF format can be submitted.

The SIRIUS ACT Configurator must be used to select special inscriptions and symbols (order code Q9Y). In this case a "CIN" (Configuration Identification Number) is generated for placement of future orders. It is then possible to place an order directly using the CIN and the SIRIUS ACT Configurator (Mall shopping cart) or via the standard order channels.

Standard ordering channels:

- Configurator: www.siemens.com/sirius-act/configurator
- Electronic Catalog CA 01 on DVD
- Industry Mall: www.usa.siemens.com/industrymall

Ordering example 1

A label with 2 lines of text is required:

3SU1900-0AF16-0AZ0
Q1Y
Z1 = LIFT
Z2 = LOWER

Ordering example 2

A label inscribed with symbol No. 5011 according to IEC 60417 is required:

3SU1900-0AF16-0AZ0
Q3Y
Z = 5011 IEC

Ordering example 3

A label inscribed with symbol No. 1118 according to ISO 7000 is required:

3SU1900-0AF16-0AZ0
Q3Y
Z = 1118 ISO

Labels

Labels for laser printers

Overview

Label inscriptions



Using the *Label Designer* software, which can be downloaded from the Internet, and the labeling plates for laser inscription you can create your own customized labels with a standard laser printer. The self-adhesive or snap-on labels can be stuck or snapped onto the corresponding label holders. Round labels are provided for inserting in illuminated pushbuttons and switches.

The labels are suitable for inscription with one to three lines of text or symbols.

For applications with more exacting requirements we recommend factory-printed labeling plates and insert labels (laser-printed or engraved depending on the type).

For the *Label Designer* software see: www.siemens.com/sirius-label-designer

Selection and ordering data

	Fastening method	Height mm	Width mm	DT	Order No.	PU (UNIT, SET, M)	PS*
Labels for printing - insert labels							
	Insert	--	--	B	3SU1900-0BH60-0AA0	100	480 units
3SU1900-0BH60-0AA0							
Labels for printing - labeling plates							
	Self-adhesive	12.5	27.5	A	3SU1900-0BJ61-0AA0	100	480 units
		17.5	27	A	3SU1900-0BK61-0AA0	100	720 units
		27	27	A	3SU1900-0BL61-0AA0	100	480 units
		22	22	A	3SU1900-0BM61-0AA0	100	700 units
3SU1900-0BJ61-0AA0							

Labels

Other labels

Selection and ordering data



Color	Fastening method	Outer diameter mm	Marking	DT	Order No.	PU (UNIT, SET, M)	PS*
EMERGENCY STOP backing plates							
	Yellow/Black (label/lettering)	None	45	None	A	3SU1900-0BA31-0AA0	1 10 units
			75	None	A	3SU1900-0BB31-0AA0	1 10 units
			75	EMERGENCY STOP	A	3SU1900-0BB31-0DA0	1 10 units

For Custom Inscription

For inscription or symbol options refer to page 112

3SU1900-0BB31-0AA0

EMERGENCY STOP backing plates

	Yellow/Black (label/lettering)	Self-adhesive	75	None	▶	3SU1900-0BC31-0AA0	1 10 units
						▶	3SU1900-0BC31-0DA0
	Yellow/Black (label/lettering)	Self-adhesive	75	NOT-HALT, EMERGENCY STOP, EMERGENZA, EMERGENCIA (de, en, it, sp)	A	3SU1900-0BC31-0NB0	1 10 units
						For Custom Inscription	

For inscription or symbol options refer to page 112

3SU1900-0BC31-0NB0

Labeling plates for potentiometers

	Black/White (label/lettering)	None	40	--	▶	3SU1900-0BG16-0AA0	1 10 units
				SYMBOL: 0 ... 9	▶	3SU1900-0BG16-0RT0	1 10 units
				SYMBOL: 0 ... 10	3	3SU1900-0BG16-0SA0	1 10 units
				SYMBOL: Power up	▶	3SU1900-0BG16-0RU0	1 10 units

3SU1900-0BG16-0RU0

Color	Label fastening method	Height mm	Width mm	Marking	DT	Order No.	PU (UNIT, SET, M)	PS*
-------	------------------------	--------------	-------------	---------	----	-----------	-------------------------	-----

Labeling plates for enclosures with EMERGENCY STOP

	Yellow/Black (label/lettering)	Self-adhesive	38	150	None	A	3SU1900-0BE31-0AA0	1 10 units
---	-----------------------------------	---------------	----	-----	------	---	---------------------------	------------

3SU1900-0BE31-0AA0

Labeling plates for enclosures with EMERGENCY STOP with recess

	Yellow/Black (label/lettering)	Self-adhesive	38	150	None	B	3SU1900-0BF31-0AA0	1 10 units
---	-----------------------------------	---------------	----	-----	------	---	---------------------------	------------

3SU1900-0BF31-0AA0

Unit labeling plates

	White/Black (label/lettering)	Insert	9.5	10.5	None	B	3SU1900-0AY61-0AA0	100 10 units
---	----------------------------------	--------	-----	------	------	---	---------------------------	--------------

3SU1900-0BY61-0AA0

Labels

Other labels

Options

Customized inscriptions

The labels can be inscribed with text and symbols not listed in the ordering data.

The emergency stop backing plates are divided into four segments. Each segment can be customized individually. The letter height depends on the chosen number of characters and can be adjusted.

Example: Four segments of the emergency backing plate for customized inscription

**Ordering notes**

Append the following order codes to the Order No.:

- Text line(s) in upper/lower case, upper case always for beginning of line (e.g. "Text"): **Q0Y**
- Text line(s) in upper case (e.g. "TEXT"): **Q1Y**
- Text line(s) in lower case (e.g. "text"): **Q2Y**
- Text line(s) in upper/lower case, all words begin with

- uppercase letters (e.g. "Text / Text"): **Q5Y**
- Symbol with number according to ISO 7000 or IEC 60417: **Q3Y**

When ordering, specify the required inscription in plain text in addition to the article number and order code. In the case of special inscriptions with words in languages other than English, give the exact spelling and specify the language. In the case of multi-line inscriptions, the text must be assigned to the respective line, e.g. "Z1 = Lift, Z2 =Lower". For long words you can also specify the end-of-line division (see [ordering example 1](#)).

Symbols can also be ordered with numbers according to ISO 7000 or IEC 60417; (see [ordering example 2](#)).

The SIRIUS ACT Configurator must be used to select customized inscriptions and symbols (order code **Q9Y**). In this case a "CIN" (Configuration Identification Number) is generated for placement of future orders. It is then possible to place an order directly using the CIN and the SIRIUS ACT Configurator (Mail shopping cart) or via the standard order channels.

Standard ordering channels:

- Configurator: www.siemens.com/sirius-act/configurator
- Electronic Catalog CA 01 on DVD
- Industry Mall: www.usa.siemens.com/industrymall

Ordering example 1

A label with 2 lines of text is required:

3SU1900-0BB31-0AZ0

Q1Y
Z1=Text 1
Z2=Text 2

Ordering example 2

A label inscribed with symbol No. 5638 according to IEC 60417 is required:







3SU1900-0BB31-0AZ0

Q3Y
Z=IEC5638

Accessories



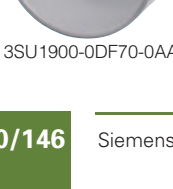

Protection/access protection

Selection and ordering data

Product version	Material	Color	DT	Order No.	PU (UNIT, SET, M)	PS*	
Protective caps							
	Sealable caps	Plastic	Black	B	3SU1900-0DA10-0AA0	1	1 unit
			Clear	B	3SU1900-0DA70-0AA0	1	1 unit
3SU1900-0DA10-0AA0							
	Sealable caps for pushbuttons	Plastic	Black	B	3SU1900-0EL10-0AA0	1	1 unit
			Clear	B	3SU1900-0EL70-0AA0	1	1 unit
3SU1900-0EL70-0AA0							
	Silicone protective caps for pushbuttons, flat	Plastic	Clear	A	3SU1900-0DB70-0AA0	1	1 unit
				A	3SU1900-0ED70-0AA0	1	1 unit
3SU1900-0DB70-0AA0							
	Silicone protective caps for pushbuttons, raised	Plastic	Clear	A	3SU1900-0DC70-0AA0	1	1 unit
				A	3SU1900-0EE70-0AA0	1	1 unit
3SU1900-0DC70-0AA0							
	Silicone-free protective caps for pushbuttons, raised	Plastic	Clear	B	3SU1900-0DD70-0AA0	1	1 unit
				B	3SU1900-0EF70-0AA0	1	1 unit
3SU1900-0DD70-0AA0							
	Silicone protective caps for selectors, short	Plastic	Clear	B	3SU1900-0DE70-0AA0	1	1 unit
				B	3SU1900-0EG70-0AA0	1	1 unit
3SU1900-0DE70-0AA0							
	Silicone protective caps for mushroom pushbuttons 40 mm	Plastic	Clear	B	3SU1900-0DF70-0AA0	1	1 unit
				B	3SU1900-0EH70-0AA0	1	1 unit
3SU1900-0DF70-0AA0							
	Silicone-free protective caps for mushroom pushbuttons 40 mm	Plastic	Clear	B	3SU1900-0DF70-0AA0	1	1 unit
				B	3SU1900-0EH70-0AA0	1	1 unit
3SU1900-0DF70-0AA0							







Accessories

Protection/access protection

Product version	Material	Color	DT	Order No.	PU (UNIT, SET, M)	PS*
Protective caps						
 3SU1900-0DG70-0AA0	Silicone protective caps for twin pushbuttons, flat	Plastic	Clear	▶	3SU1900-0DG70-0AA0	1 1 unit
	Silicone protective caps for twin pushbuttons, raised	Plastic	Clear	B	3SU1900-0DH70-0AA0	1 1 unit
	Silicone-free protective caps for twin pushbuttons, raised	Plastic	Clear	B	3SU1900-0EK70-0AA0	1 1 unit
 3SU1900-0EB10-0AA0	Dust caps for key-operated switches	Plastic	Black	B	3SU1900-0EB10-0AA0	1 1 unit
Protective collars						
 3SU1900-0DJ10-0AA0	Sun collar for illuminated pushbuttons	Plastic	Black	5	3SU1900-0DJ10-0AA0	1 1 unit
 3SU1900-0DW10-0AA0	360° protective collars for pushbuttons and selectors, short	Plastic	Black	B	3SU1900-0DW10-0AA0	1 1 unit







Accessories

Protection/access protection

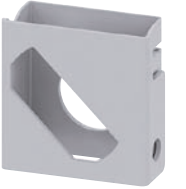
Product version	Material	Color	DT	Order No.	PU (UNIT, SET, M)	PS*
Protective collars						
	360° protective collars for pushbuttons, visibility from the side	Metal	Silver	B	3SU1950-ODK80-0AA0	1 1 unit
3SU1950-ODK80-0AA0						
	360° protective collars for mushroom pushbuttons 40 mm, visibility from the side	Metal	Silver	B	3SU1950-ODL80-0AA0	1 1 unit
3SU1950-ODL80-0AA0						
	Protective collars for EMERGENCY STOP	Plastic	Yellow Silver	▶	3SU1900-ODY30-0AA0 3SU1900-ODY80-0AA0	1 1 unit 1 1 unit
3SU1900-ODY30-0AA0	With text "EMERGENCY STOP"	Plastic	Yellow	▶	3SU1900-ODY30-0DA0	1 1 unit
	Protective collars for padlocks	Metal	Yellow Silver	B B	3SU1950-ODX30-0AA0 3SU1950-ODX80-0AA0	1 1 unit 1 1 unit
3SU1950-ODX30-0AA0						
	360° protective collars for EMERGENCY STOP, SEMI-Industry	Plastic	Yellow	B	3SU1900-0EA30-0AA0	1 1 unit
	Protection for sensor switch	Plastic	Black	B	3SU1900-0EC10-0AA0	1 1 unit
3SU1900-0EC10-0AA0						

Accessories

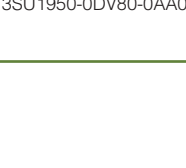

Protection/access protection

Product version	Material	Color	DT	Order No.	PU (UNIT, SET, M)	PS*
Locking devices						
	Metal	Silver	B	3SU1950-0DM80-0AA0	1	1 unit
	Metal	Silver	B	3SU1950-0DN80-0AA0	1	1 unit
	Metal	Silver	B	3SU1950-0DP80-0AA0	1	1 unit
	Metal	Silver	B	3SU1950-0DQ80-0AA0	1	1 unit
	Metal	Silver	B	3SU1950-0DR80-0AA0	1	1 unit
	Metal	Silver	B	3SU1950-0DS80-0AA0	1	1 unit
	Metal	Silver	B	3SU1950-0DT80-0AA0	1	1 unit
	Metal	Silver	B	3SU1950-0DU80-0AA0	1	1 unit
	Metal	Silver	B	3SU1950-0DV80-0AA0	1	1 unit









Accessories

Actuators

Selection and ordering data





Material	Mounting diameter mm	Color	SD d	Article No.	Price per PU	PU (UNIT, SET, M)	PS*
Sealing plugs¹⁾, 22 mm							
Plastic	22	Black	▶	3SU1900-0FA10-0AA0		1	1 unit
							
3SU1900-0FA10-0AA0							
Metal, matte	22	Sand gray	▶	3SU1930-0FA80-0AA0		1	1 unit
Metal, shiny	22	Silver	▶	3SU1950-0FA80-0AA0		1	1 unit
							
3SU1950-0FA80-0AA0							
Metal, matte	30	Sand gray	▶	3SU1960-0FA80-0AA0		1	1 unit

¹⁾ The sealing plug is mounted with a holder. Modules might already be mounted on the holder.

Type of product	Outer diameter of the actuating element mm	Accessory color	Accessory material	SD d	Screw terminals	PU (UNIT, SET, M)	PS*
					Article No.	Price per PU	
USB port <i>NEW</i>							
USB 3.0	22	Black	Plastic	3	3SU1900-0GA10-0AA0		1 1 unit
							
		Sand gray	Metal/plastic	3	3SU1930-0GA80-0AA0		1 1 unit
		Silver	Metal, shiny	3	3SU1950-0GA80-0AA0		1 1 unit
	30	Sand gray	Metal, matte	3	3SU1960-0GA80-0AA0		1 1 unit
							
3SU1930-0GA80-0AA0							
							
3SU1960-0GA80-0AA0							
							
3SU1960-0GA80-0AA0							
RJ45 connection <i>NEW</i>							
RJ-45 Cat. 6	22	Black	Plastic	3	3SU1900-0GB10-0AA0		1 1 unit
							
		Sand gray	Metal/plastic	3	3SU1930-0GB80-0AA0		1 1 unit
		Silver	Metal, shiny	3	3SU1950-0GB80-0AA0		1 1 unit
	30	Sand gray	Metal, matte	3	3SU1960-0GB80-0AA0		1 1 unit
							
3SU1900-0GB10-0AA0							
							
3SU1950-0GB80-0AA0							
							
3SU1960-0GB80-0AA0							

Accessories







Actuators

Material	Color	SD	Article No.	Price per PU	PU (UNIT, SET, M)	PS*
Buttons, flat¹⁾						
For pushbuttons						
 3SU1900-0FT20-0AA0	Plastic	Black	▶ 3SU1900-0FT10-0AA0		100	10 units
		Red	▶ 3SU1900-0FT20-0AA0		100	10 units
		Yellow	▶ 3SU1900-0FT30-0AA0		100	10 units
		Green	▶ 3SU1900-0FT40-0AA0		100	10 units
		Blue	▶ 3SU1900-0FT50-0AA0		100	10 units
		White	▶ 3SU1900-0FT60-0AA0		100	10 units
For illuminated pushbuttons						
 3SU1901-0FT30-0AA0	Plastic	Amber	▶ 3SU1901-0FT00-0AA0		100	10 units
		Red	▶ 3SU1901-0FT20-0AA0		100	10 units
		Yellow	▶ 3SU1901-0FT30-0AA0		100	10 units
		Green	▶ 3SU1901-0FT40-0AA0		100	10 units
		Blue	▶ 3SU1901-0FT50-0AA0		100	10 units
		White	▶ 3SU1901-0FT60-0AA0		100	10 units
		Clear	▶ 3SU1901-0FT70-0AA0		100	10 units
	Buttons, raised¹⁾					
For pushbuttons						
 3SU1900-0FS30-0AA0	Plastic	Black	▶ 3SU1900-0FS10-0AA0		1	10 units
		Red	▶ 3SU1900-0FS20-0AA0		1	10 units
		Yellow	▶ 3SU1900-0FS30-0AA0		1	10 units
		Green	▶ 3SU1900-0FS40-0AA0		1	10 units
For illuminated pushbuttons						
 3SU1901-0FS40-0AA0	Plastic	Red	▶ 3SU1901-0FS20-0AA0		1	10 units
		Yellow	▶ 3SU1901-0FS30-0AA0		1	10 units
		Green	▶ 3SU1901-0FS40-0AA0		1	10 units
		Blue	▶ 3SU1901-0FS50-0AA0		1	10 units
		Clear	▶ 3SU1901-0FS70-0AA0		1	10 units

¹⁾ Buttons are not interchangeable between pushbuttons and illuminated pushbuttons with a raised button and those with a flat button (raised front ring, castellated).

Accessories

Actuators

	Material	Key number	RFID coding version	Color	DT	Order No.	PU (UNIT, SET, M)	PS*
Ronis keys								
	Metal	SB30	--	Silver	▶	3SU1950-0FB80-0AA0	1	1 unit
		455			B		3SU1950-0FC80-0AA0	1
3SSU1950-0FB80-0AA0								
BKS keys								
	Metal	S1	--	Silver	B	3SU1950-0FD80-0AA0	1	1 unit
3SSU1950-0FD80-0AA0								
OMR keys								
	Metal	73038	--	Blue	B	3SU1950-0FJ50-0AA0	1	1 unit
		73037		Red	B	3SU1950-0FK20-0AA0	1	1 unit
		73034		Black	B	3SU1950-0FL10-0AA0	1	1 unit
		73033		Yellow	B	3SU1950-0FM30-0AA0	1	1 unit
3SSU1950-0FJ50-0AA0								
CES keys								
	Metal	LSG1	--	Silver	B	3SU1950-0FN80-0AA0	1	1 unit
		SSG10			A	3SU1950-0FP80-0AA0	1	1 unit
		VL5			B	3SU1950-0FQ80-0AA0	1	1 unit
3SSU1950-0FP80-0AA0								
IKON keys								
	Metal	360012K1	--	Silver	B	3SU1950-0FR80-0AA0	1	1 unit
3SU1950-0FR80-0AA0								
ID keys ID group individual								
	Plastic	--	Individually coded, programmable several times	White	X	3SU1900-0FU60-0AA0	1	1 unit
3SU1900-0FU60-0AA0								
ID keys								
	Plastic	--	ID group 1	Green	X	3SU1900-0FV40-0AA0	1	1 unit
		--	ID group 2	Yellow	X	3SU1900-0FW30-0AA0	1	1 unit
		--	ID group 3	Red	X	3SU1900-0FX20-0AA0	1	1 unit
		--	ID group 4	Blue	X	3SU1900-0FY50-0AA0	1	1 unit
3SU1900-0FV40-0AA0								

Accessories

Enclosures

Selection and ordering data

Product version	Material	Color	SD	Article No.	Price per PU	PU (UNIT, SET, M)	PS*	
Metric cable glands								
 <p>3SU1900-0HG10-0AA0</p>	M20 for round cable and enclosures With 1 to 3 command points	Plastic	Black	▶	3SU1900-0HG10-0AA0	1	1 unit	
	M25 for round cable and enclosures With 4 and 6 command points				5	3SU1900-0HH10-0AA0	1	1 unit
	M20 for round cable and AS-i enclosure With 1 to 3 command points with 2-pin connector plug for AS-i module				3	3SU1900-0JA10-0AA0	1	1 unit
	M25 for round cable and AS-i enclosure With 4 to 6 command points with 2-pin connector plug for AS-i module				3	3SU1900-0JB10-0AA0	1	1 unit
	M20 for round cable and IO-Link enclosure With 1 to 3 command points with 10-pin connector plug for IO-Link	NEW			▶	3SU1900-0JC10-0AA0	1	1 unit
	M25 for round cable and IO-Link enclosure With 4 to 6 command points with 10-pin connector plug for IO-Link	NEW			▶	3SU1900-0JD10-0AA0	1	1 unit
	M20 for AS-i profile cable and AS-i enclosure With 1 to 3 command points with 2-pin connector plug for AS-i module	NEW			5	3SU1900-0HE10-0AA0	1	1 unit
	M25 for AS-i profile cable and AS-i enclosure With 4 to 6 command points with 2-pin connector plug for AS-i module	NEW			5	3SU1900-0HF10-0AA0	1	1 unit
Connection pieces								
 <p>3SU1900-0HJ10-0AA0</p>	For plastic enclosures							
	M20/M20 connection piece For connecting 2 enclosures	Plastic	Black	▶	3SU1900-0HJ10-0AA0	1	1 unit	
	M20/M25 connection piece For connecting 2 enclosures				5	3SU1900-0HK10-0AA0	1	1 unit
	M25/M25 connection piece For connecting 2 enclosures				5	3SU1900-0HL10-0AA0	1	1 unit
 <p>3SU1950-0HJ10-0AA0</p>	For metal enclosures							
	M20/M20 connection piece For connecting 2 enclosures	Metal	Silver	5	3SU1950-0HJ10-0AA0	1	1 unit	
	M20/M25 connection piece For connecting 2 enclosures				5	3SU1950-0HK10-0AA0	1	1 unit
	M25/M25 connection piece For connecting 2 enclosures				5	3SU1950-0HL10-0AA0	1	1 unit

Accessories







Enclosures

Product version	Material	Color	DT	Insulation piercing method		PU (UNIT, SET, M)	PS*	
				Order No.				
Adapters for AS-i shaped cables								
	Insulation piercing method	Plastic	Black	B				
	M20							
	M25							
				3SU1900-0HX10-0AA0		1	1 unit	
				3SU1900-0HY10-0AA0		1	1 unit	
Adapters								
For plastic enclosures								
	M12 sockets, 4-pole	Plastic	Black	B				
	M20							
		M25						
					3SU1930-0HA10-0AA0		1	1 unit
					3SU1930-0HB10-0AA0		1	1 unit
	M12 connectors, 4-pole			B				
	M20							
		M25						
					3SU1930-0HC10-0AA0		1	1 unit
					3SU1930-0HD10-0AA0		1	1 unit
	M12 sockets, 5-pole	Plastic	Black	B				
	M20							
	M25							
				3SU1930-0HP10-0AA0		1	1 unit	
				3SU1930-0HQ10-0AA0		1	1 unit	
M12 connectors, 5-pole			B					
M20								
	M25							
				3SU1930-0HR10-0AA0		1	1 unit	
				3SU1930-0HS10-0AA0		1	1 unit	
M12 sockets, 8-pole	Plastic	Black	B					
M20								
	M25							
				3SU1930-0HT10-0AA0		1	1 unit	
				3SU1930-0HU10-0AA0		1	1 unit	
M12 connectors, 8-pole			B					
M20								
	M25							
				3SU1930-0HV10-0AA0		1	1 unit	
				3SU1930-0HW10-0AA0		1	1 unit	
For metal enclosures								
	M12 sockets, 4-pole	Metal	Black	B				
	M20							
		M25						
					3SU1950-0HA10-0AA0		1	1 unit
					3SU1950-0HB10-0AA0		1	1 unit
	M12 connectors, 4-pole			B				
	M20							
		M25						
					3SU1950-0HC10-0AA0		1	1 unit
					3SU1950-0HD10-0AA0		1	1 unit
	M12 sockets, 5-pole	Metal	Black	B				
	M20							
	M25							
				3SU1950-0HP10-0AA0		1	1 unit	
				3SU1950-0HQ10-0AA0		1	1 unit	
M12 connectors, 5-pole			B					
M20								
	M25							
				3SU1950-0HR10-0AA0		1	1 unit	
				3SU1950-0HS10-0AA0		1	1 unit	
M12 sockets, 8-pole	Metal	Black	B					
M20								
	M25							
				3SU1950-0HT10-0AA0		1	1 unit	
				3SU1950-0HU10-0AA0		1	1 unit	
M12 connectors, 8-pole			B					
M20								
	M25							
				3SU1950-0HV10-0AA0		1	1 unit	
				3SU1950-0HW10-0AA0		1	1 unit	
Enclosure cover monitoring								
	Enclosure cover monitoring (module with extension plunger)	Plastic	Black	B				
				3SU1900-0HM10-0AA0		1	1 unit	

Accessories

Miscellaneous accessories

Selection and ordering data

Product designation Product version	Material	Color	SD	Article No.	Price per PU	PU (UNIT, SET, M)	PS*
Miscellaneous accessories							
 3SU1900-0KA10-0AA0	PCB carriers	Plastic	Black	5	3SU1900-0KA10-0AA0	100	10 units
 3SU1900-0CK10-0AA0	Pressure plates for selectors and locks	Plastic	White	▶	3SU1900-0CK10-0AA0	100	10 units
 3SU1900-0KF10-0AA0	Drilling template for grid 30 x 40, horizontal	Plastic	Black	5	3SU1900-0KF10-0AA0	1	1 unit
 3SU1900-0KG10-0AA0	Extension plungers For compensation of the distance between the pushbutton and the unlatching button of an overload relay	Plastic	Gray	▶	3SU1900-0KG10-0AA0	1	1 unit
 3SU1950-0JE80-0AA0	Strut profile mounting adapters NEW	Metal	Sand gray	3	3SU1950-0JE80-0AA0	1	1 unit
	Adapters NEW Between enclosure top and bottom	Plastic	Black	5	3SU1900-0JF10-0AA0	1	1 unit
 3SU1900-0KH80-0AA0	Adapters for standard rail mounting	Plastic	Black	▶	3SU1900-0KH80-0AA0	1	1 unit

Accessories

Miscellaneous accessories



3SU1950-0KJ80-0AA0



3SU1950-0KB10-0AA0

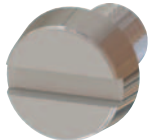

3SU1950-0KK80-0AA0



3SU1900-0KL10-0AA0

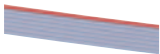

3SU1900-0KP80-0AA0

Product designation Product version	Material	Color	SD	Article No.	Price per PU	PU (UNIT, SET, M)	PS*
Adapters for actuators and indicators With front ring for flat mounting	Metal	Silver	d ▶	3SU1950-0KJ80-0AA0		1	1 unit
Adapters for 30.5 mm to 22.5 mm mounting hole	Metal, shiny	Silver	▶	3SU1950-0KB10-0AA0		1	1 unit
NEW	Metal, matte	Sand gray	▶	3SU1960-0KB10-0AA0		1	1 unit
Grounding studs	Metal	Silver	5	3SU1950-0KK80-0AA0		100	50 units
Connectors for sensor switches, angled socket with screw terminal connection	Plastic	Black	▶	3SU1900-0KL10-0AA0		1	1 unit
Flat ribbon cable 7 cores							
• Length 10 m	Plastic	Gray	5	3SU1900-0KQ80-0AA0		1	1 unit
• Length 5 m	Plastic	Gray	5	3SU1900-0KP80-0AA0		1	1 unit

Standards and approvals

Approvals, test certificates, characteristic curves

An overview of the certificates available for Industrial Control products along with more technical documentation can be consulted daily on the Internet at:

www.siemens.com/sirius/approvals

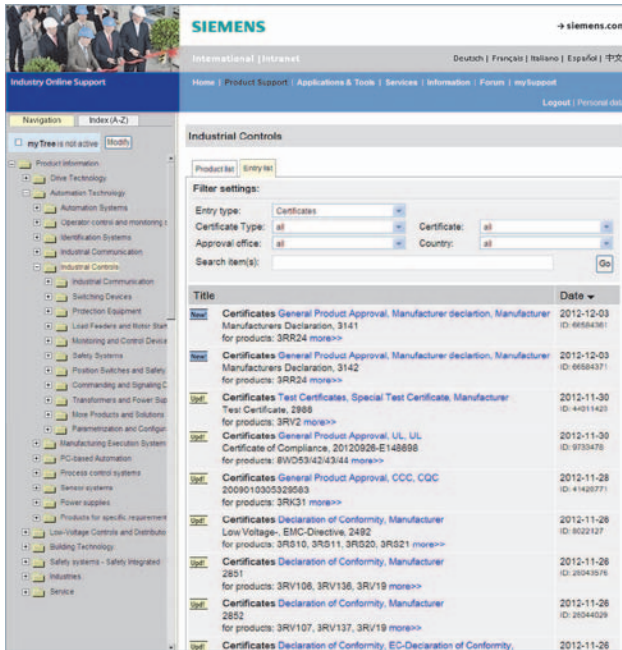

Product support: Approvals/certificates

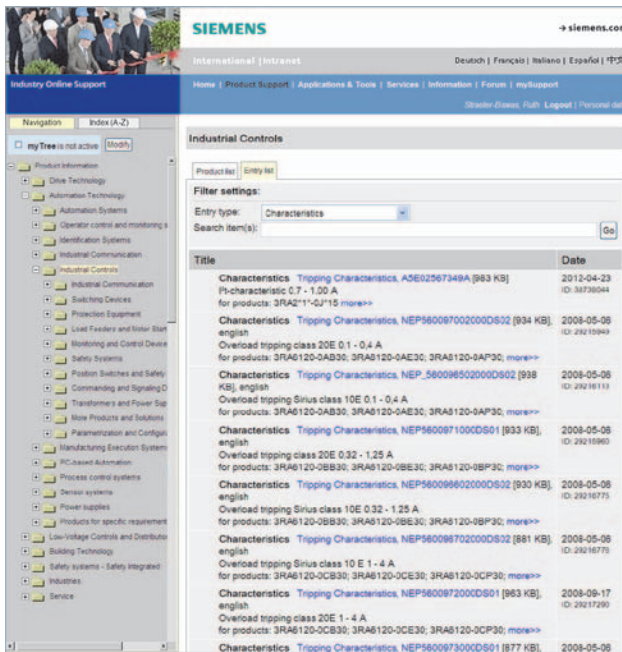

Product support: Characteristics

Safety characteristics

In the following standards, the so-called B10 values for calculating the safety integrity or safety integrity level (SIL) in functional safety at a high or continuous demand rate are required also for electromechanical switchgear:

- IEC 62061 "Safety of machines – Functional safety of safety-related electrical, electronic and programmable electronic control systems",
- ISO 13849-1 "Safety of machines – Safety-related components of controls – Part 1: General principles".

Failure rates of electromechanical components are required for calculating the safety integrity or safety integrity level (SIL) in functional safety:

- in the manufacturing industry at a high demand rate
- in the process industry at a low demand rate

Further requirements are laid down in IEC 61511-1 "Functional safety – Safety instrumented systems for the process industry sector – Part 1: Framework, definitions, system, hardware and software requirements".

The German versions of the above standards are:

- EN 62061 (VDE 0113-50), 2005 + AMD 1:2013, which since 31.12.2005 has been harmonized as EN 62061 under the Machinery Directive
- EN ISO 13849-1:2008
- EN 61511-1 (VDE 810-1)

The TÜV-tested Safety Evaluation Tool assists in calculating the safety function as verification for the machine documentation. It is available on the Internet at

www.siemens.com/safety-evaluation-tool.

At www.siemens.com/safety-integrated you will also find examples of functions with calculations according to the current standards.

Definitions

$\lambda(t) dt$ is the probability that a unit which has not failed by a certain time t will fail in the following interval $(t; t + dt)$. Failure rates have the dimension 1/time unit, e.g. 1/h. Failure rates for components are often specified in FIT (failures in time unit): 1 FIT equals $10^{-9}/h$.

From the failure rate it is possible to derive a (mathematical) distribution function of the failure probability:

$F(t) = 1 - \exp(-\lambda t)$, with λ as constant failure rate

- The mean value of this exponential distribution is also referred to as:
 - Mean Time To Failure (MTTF) in the case of irreparable components; 63.2 % of components fail by the MTTF.
 - Mean Operating Time Between Failures (MTBF) in the case of reparable components.
- $MTTF = 1/\lambda$
(MTTF is a statistical mean value but no guarantee for endurance)

Electromechanical components are often irreparable components. In general, the failure rate of monitored units changes with age.

Standards and approvals

The B10 value for devices subject to wear is expressed in number of operating cycles:

- it is the number of operating cycles after which 10 % of the test specimens fail in the course of an endurance test (or: the number of operating cycles after which 10 % of the devices have failed).

For low demand rates (mainly in the process industry), the failure rate and not the B10 value is used to determine the failure probability.

Standard B10 values at a high demand rate

With the help of the B10 value and a simplified formula (see section 6.7.8.2.1 of EN 62061), the user can then calculate the total failure rate of an electromechanical component:

$$\lambda = 0.1 \times C/B10$$

with C = operating cycles per hour. C is specified by the user.

The failure rate is made up of safe (λ_S) and dangerous (λ_D) failures:

$$\lambda = \lambda_S + \lambda_D$$

or

$$\lambda_D = [\text{share of dangerous failures in \%}] \times \lambda$$

$$\lambda_S = [\text{share of safe failures in \%}] \times \lambda$$

The failure rate of the dangerous failures λ_D of the components used is needed for further calculations.

Listed in the following table are the standard B10 values and the share of dangerous failures for SIRIUS product groups at a high demand rate.

Standard B10 values (at a high demand rate)		
SIRIUS ACT product group (electromechanical components)	Standard B10 value ¹⁾ (operating cycles)	Share of dangerous failures
3SU1 EMERGENCY-STOP mushroom pushbuttons (with positive-opening contacts)	100 000	20 %
3SU1 pushbuttons (non-latching, with positive-opening contacts)	10 000 000	20 %

¹⁾ Only applies under the conditions specified in the technical specifications.

The B10_d value used in EN ISO 13849-1:2008 is determined as follows:

$$B10_d = \frac{B10}{\text{Share of dangerous failures}}$$

Calculation example

A protective door is monitored by a position switch with a separate actuator.

The protective door is opened 4 times an hour.

The overall failure rate of the position switch is:

$$\lambda = 0.1 \cdot C/B10 \text{ [failures/h]}$$

$$\lambda = 0.1 \cdot 4/1000000 = 4 \cdot 10^{-7} \text{ [failures/h]}$$

The dangerous failure rate is calculated with:

$$\lambda_D = 20 \% \text{ of } \lambda = 0.2 \cdot 4 \cdot 10^{-7} \text{ [failures/h]}$$

$$\lambda_D = 8 \cdot 10^{-8} \text{ [failures/h]}$$

Standard failure rates (at a low demand rate)

On the basis of the failure rates, it is possible to calculate the average probability of failure on demand (PFD_{avg}) of a PLT protective device.

A so-called low demand rate is assumed, meaning the rate of demand on the safety-related system amounts to no more than once a year and is not greater than double the frequency of the repeat test.

A repeat test once a year is recommended for electromechanical components in order to reveal passive faults.

For special applications it is possible, in agreement with the inspecting institution (e.g. a technical inspectorate, government agency or the like) to extend the test intervals by using suitable solutions (e.g. a multi-channel version etc.).

Listed in the following table are the standard failure rates and the share of dangerous failures for SIRIUS product groups at a low demand rate.

Standard failure rates at a low demand rate		
SIRIUS ACT product group (electromechanical components)	Standard failure rates (in FIT) ¹⁾	Share of dangerous failures
3SU1 EMERGENCY-STOP mushroom pushbuttons (with positive-opening contacts)	100	20 %
3SU1 pushbuttons (non-latching, with positive-opening contacts)	100	20 %

¹⁾ The failure rates specified in the table were limited to 100 FIT.

3SE2, 3SE3 Foot Switches

Plastic and metal enclosures

Overview

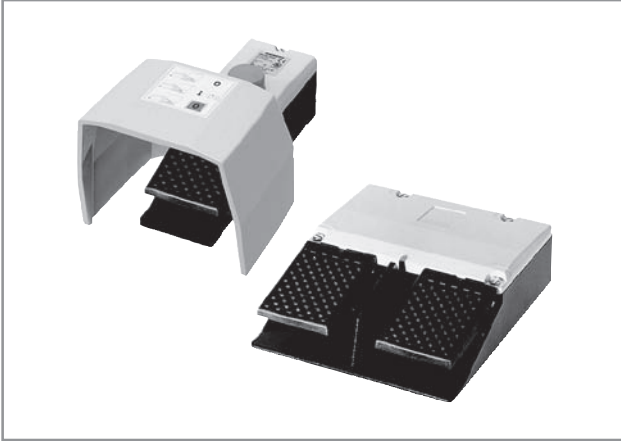

Foot switches with metal enclosures

Standard switches

The 3SE2 9 and 3SE3 9 foot switch range encompasses versions in a metal enclosure for rugged applications as well as versions with plastic enclosure for less harsh environments. The devices can be supplied with or without a cover and have fixing holes for them to be screwed to the floor.

Depending on the particular application, the metal enclosures can be ordered in latching or momentary-contact versions. The momentary-contact pedal switch in the plastic enclosure has one microswitch (changeover contact) per actuating pedal.

Safety foot switches

The 3SE2 924-3AA20 single-pedal safety foot switches are used on machines and plants as OK switches when operation by hand is not possible and the EMERGENCY-STOP function must be available if a hazardous status arises. The switches are interlocked according to EN ISO 13850 and bear the CE mark in accordance with the machinery directive.

The safety foot switches are protected by a guard hood against accidental operation.

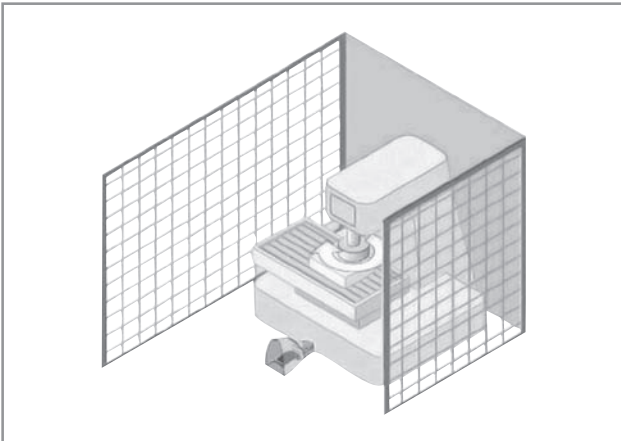

Application example

The switches have two contact blocks, each with one NO contact and one NC contact. The NO contacts and NC contacts of the two contact blocks are connected for easy connection of a single-phase motor. The normal workflow is initiated by pressing down the pedal as far as the pressure point so that the two NO contacts close and the motor starts to run.

If in the event of danger the pedal is pressed beyond the resistance of the pressure point, the positively driven NC contacts will open and the motor is stopped. At the same time the independent latching takes effect and holds the NC contacts in open position. This prevents the machine parts from continuing to run out of control or from being restarted.

After the hazard is eliminated, the machine can only be restarted after manually releasing the switch using a push button on the top of the enclosure. The contacts are then released again and return to their initial position (the NO contacts are open and the NC contacts are closed).

Technical specifications

Type	3SE29	3SE39
Metal and plastic enclosures		
Standards	IEC 60947-5-1	
Electrical load		
• At AC-15, 400 V		
- 1 NO + 1 NC	A 16	—
- 2 NO + 2 NC	A 6	—
- 3SE2 924-3AA20 (2 NO + 2 NC)	A 16	—
• At 250 V AC	A —	5
Short-circuit protection		
- 1 NO + 1 NC / 3SE2 924-3AA20	A 16 (slow)	—
- 2 NO + 2 NC	A 6 (slow)	—
- 1 CO contact	A —	5 (slow)
Mechanical endurance	> 10 ⁶ operating cycles	
Material		
• Enclosures	Aluminum casting	Impact-resistant thermoplast, self-extinguishing according to UL 94 VO
• Covers	Thermoplast	—
• Guard hoods	Aluminum casting	Metal
Degree of protection	IP65	IP65
Ambient temperature	°C -25 ... +80	-10 ... +75
Connection	Cable entry, metric	Cable AWG20, UL Style 2464, length 3 m

3SE2, 3SE3 Foot Switches

Plastic and metal enclosures

Selection and ordering data

Version	Slow-action contacts for each pedal	SD	Article No.	Price per PU	PU (UNIT, SET, M)	PS*
Metal enclosures, degree of protection IP65						
 <p>3SE290-..AA20 3SE291-..AA20</p>	Momentary-contact foot switches, single pedal, non-latching M20 x 1.5 cable entry					
	• Without hood	1 NO + 1 NC ↻ 2	3SE2902-0AB20		1	1 unit
		2 NO + 2 NC ↻ 2	3SE2903-1AB20		1	1 unit
	• With hood	1 NO + 1 NC ↻ 2	3SE2902-0AA20		1	1 unit
		2 NO + 2 NC ↻ 2	3SE2903-1AA20		1	1 unit
	 <p>3SE2912-2AB20 3SE2912-2AA20</p>	Momentary-contact foot switches, single pedal, latching M20 x 1.5 cable entry				
• Without hood		1 NO + 1 NC ↻ 15	3SE2912-2AB20		1	1 unit
• With hood		1 NO + 1 NC ↻ 15	3SE2912-2AA20		1	1 unit
 <p>3SE2932-..AB20 3SE2932-..AA20</p>		Momentary-contact foot switches, two pedals, non-latching M25 x 1.5 cable entry				
	• Without hood	1 NO + 1 NC ↻ 5	3SE2932-0AB20		1	1 unit
		2 NO + 2 NC ↻ 5	3SE2932-1AB20		1	1 unit
	• With hood	1 NO + 1 NC ↻ 5	3SE2932-0AA20		1	1 unit
		2 NO + 2 NC ↻ 5	3SE2932-1AA20		1	1 unit
	 <p>3SE2924-3AA20</p>	Safety momentary-contact foot switches, non-latching, single pedal With hood M20 x 1.5 cable entry with interlocking function NO closes as momentary contact type NC opens with automatic latching (safety function)		2 NO + 2 NC ↻ 15	3SE2924-3AA20	1
Plastic enclosures, degree of protection IP65						
 <p>3SE3902-4CA20 3SE3934-5CB20</p>	Momentary-contact pedal switches, 3 m cable		Microswitch			
	• Single pedal					
	- Without hood	1 CO contact	5	3SE3902-4CB20	1	1 unit
	- With hood	1 CO contact	5	3SE3902-4CA20	1	1 unit
	• Two pedals, without hood	2 x 1 CO	5	3SE3934-5CB20	1	1 unit
Accessories						
	Protection cover Single pedal foot switch for 3SE2912-2AA20	--	20	3SE3980-8M	1	1 unit
	Contact block, 6 A, Supersedes momentary-contact foot switch 3SE29.2-..A.20 and 3SE29.3-..A.20	2 NO + 2 NC	X	3SE3982-0K	1	1 unit
	Contact block, 16 A, Supersedes momentary-contact foot switch 3SE29.2-0A.20	1 NO + 1 NC	X	3SE3982-0L	1	1 unit
	Contact block, 16 A, Supersedes momentary-contact foot switch 3SE2924-3AA20	2 NO + 2 NC	X	3SE3982-7J	1	1 unit
	Contact block, 16 A, Supersedes momentary-contact foot switch 3SE2912-2A.20	1 NO + 1 NC	30	3SE3982-7L	1	1 unit

↻ Positive opening according to IEC 60947-5-1, Annex K.

8WD4 Signaling Columns

General Data

Overview

The 8WD4 signaling columns are flexible in design and versatile in use.

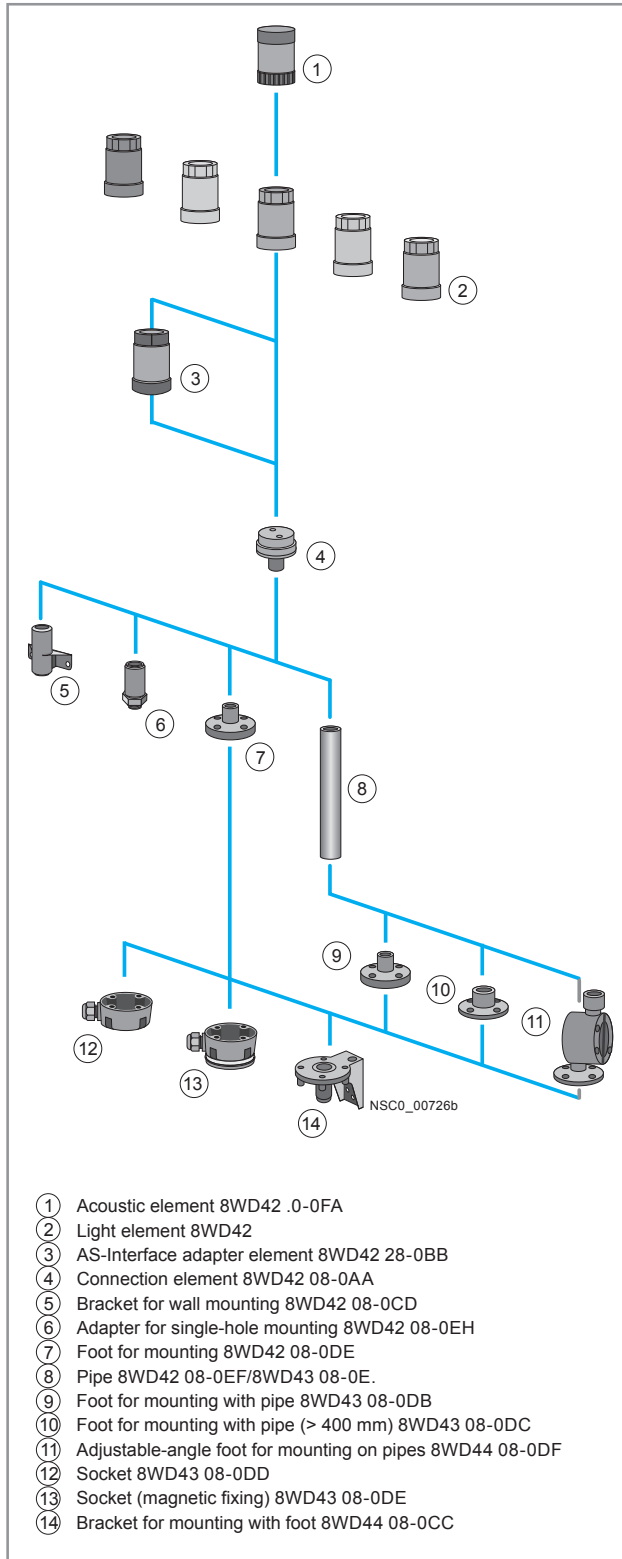

8WD42 signaling columns (width 50 mm) with up to 4 elements

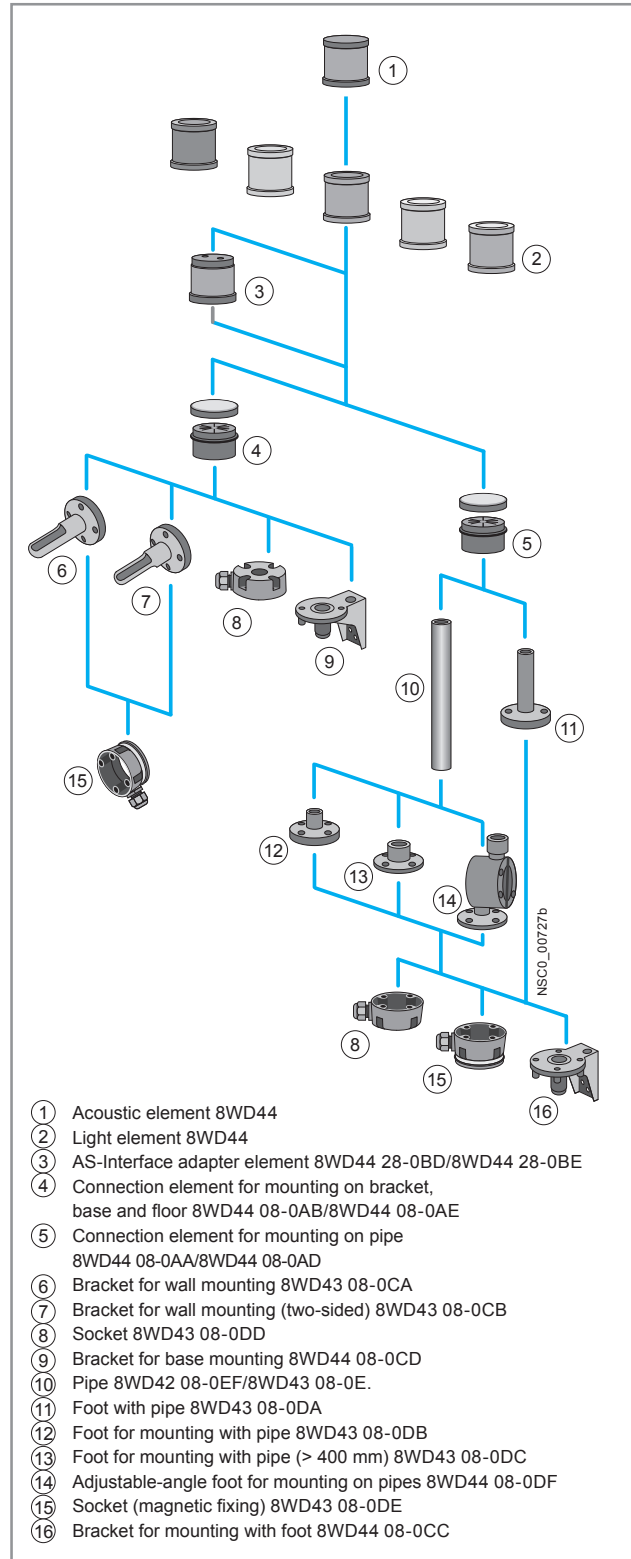

8WD44 signaling columns (width 70 mm) with up to 5 elements

8WD4 Signaling Columns

General Data

Two product series are available:

- 8WD42
 - Thermoplast enclosure, diameter 50 mm
 - Degree of protection IP54
 - Up to 4 elements can be mounted between the connection element and the cover
- 8WD44
 - Thermoplast enclosure, diameter 70 mm
 - Advanced design and significantly improved illumination
 - Faster and more flexible connection using spring-type terminals
 - Integrated degree of protection IP65
 - Up to 5 elements can be mounted between the connection element and the cover



Signaling columns, mounting examples

The illustrated examples are from the left:

- 8WD42: Cover (no No.), 4 light elements ②, connection element ④, pipe ⑧, foot ⑨
- 8WD44: Acoustic element with integral cover ①, 2 light elements ②, connection element ⑤, foot with pipe ⑪
- 8WD44: Cover (no No.), 4 light elements ②, AS-Interface adapter element ③, connection element ④, bracket for wall mounting ⑥
- 8WD44: Cover (no No.), 3 light elements ②, AS-Interface adapter element ③, connection element ⑤, foot with pipe ⑪

Note:

The cover is supplied with the connection element; it is not needed with the acoustic element.

Benefits

- Choice of various light and acoustic elements with different functions: continuous light, blinklight, flashlight and rotating light; buzzer and siren
- Light elements with particularly long-lasting LEDs
- Variety of colors: red, yellow, green, white or blue
- Optimized illumination through improved prism technology with the 8WD44
- Acoustic elements can be adjusted in tone and volume
- Extremely resistant to shock and vibrations
- Easy connection and quick lamp change with secure bayonet mechanism
- Communication capability through connection to AS-Interface

Application

8WD4 signaling columns are used in machines or in automatic processes for monitoring complex procedures or as visual or acoustic warning devices in emergency situations, e.g. for displaying individual assembly stages.

Communication capability

Connection to AS-Interface

The 8WD4 signaling columns can be directly connected to the AS-Interface bus system through an adapter element that can be integrated in the column. Wiring outlay is reduced as the result. The two-wire bus cable is fixed to the terminals in the connection element. Up to four signaling elements can be mounted on it using an adapter element.

A/B technology enables the connection of up to 62 slaves on one AS-Interface system.

Connection

The signaling elements are wired up using the screw terminals in the connection element, screw terminals on the 8WD42 and screw or spring-type terminals on the 8WD44.

Cable outlet

The connecting cables can be guided either downwards or sideways through the cable gland using an adapter that can be screwed under the foot. This makes wiring easier if there is no access from below.

Connection to AS-Interface



8WD42:

The two-wire bus cable is fixed to the screw terminals in the connection element. The adapter element must be the first module to be mounted on the connection element. A maximum of 4 signaling elements can then be mounted on it.

The adapter element 8WD42 28-0BB is a standard slave.

8WD44:

The two-wire bus cable is fixed to the screw or spring-type terminals in the connection element. The adapter element must be the first module to be mounted on the connection element. The signaling elements can then be mounted on it.

The adapter element 8WD44 28-0BE is a standard slave. A maximum of 4 signaling elements can be mounted on it.

The adapter element 8WD44 28-0BD with A/B technology enables the connection of up to 62 slaves on one AS-Interface system. The addressing socket provides user-friendly parameterization of the AS-Interface elements. A maximum of 3 signaling elements can be mounted on it.

8WD4 Signaling Columns

General Data

Technical specifications

Type	8WD42	8WD44
General data		
Approvals	UL, CSA	UL, CSA
Light and acoustic elements		
Rated voltage, power consumption		
Light elements with incandescent lamp	(AC values for 50/60 Hz)	(AC values for 50/60 Hz)
• Continuous light	12 V, 24 V, 115 V, 230 V AC/DC	12 V, 24 V, 115 V, 230 V AC/DC
• Blinklight	24 V AC/DC/125 mA; 115 V AC/20 mA; 230 V AC/15 mA	24 V AC/DC/125 mA; 115 V AC/20 mA; 230 V AC/15 mA
• Flashlights	—	24 V DC/125 mA; 115 V AC/20 mA; 230 V AC/35 mA
• Max. inrush current, blinklight/flashlight	—	500 mA
Light elements with integrated LED		
• Continuous light	24 V AC/DC/60 mA	24 V AC/DC/45 mA; 115 V AC/DC/25 mA; 230 V AC/25 mA
• Blinklight	—	24 V AC/DC/40 mA
• Rotating light	—	24 V AC/DC/70 mA
Acoustic elements		
• Buzzer element (tone: pulsating or continuous, 85 dB)	24 V AC/DC/25 mA; 115 V AC/DC/25 mA; 230 V AC/25 mA	24 V AC/DC/25 mA; 115 V AC/DC/25 mA; 230 V AC/25 mA
• Siren element (8 tones + amplification can be set, 100 dB)	—	24 V AC/DC/80 mA; 115 V AC/30 mA; 230 V AC/16 mA
• Siren element (108 dB)	—	24 V DC/100 mA
Power consumption		
• Incandescent lamps, base BA 15d	W max. 5	7
• Flashlight, flash energy	Ws —	2
Endurance		
• Flashlights	4 x 10 ⁶ flashes	4 x 10 ⁶ flashes
AS-Interface adapter elements		
IO code/ID code	8/F	8/E
Power supply		
• Operational voltage	V 18.5 ... 31.6	Through bus cable 18.5 ... 31.6
• Power consumption I_{max}	mA 50	100
Protective measures		
• Watchdog	✓	✓
• Short-circuit/overload protection	External back-up fuse M 1.6 A	✓
• Reverse polarity protection	✓	✓
• Induction protection	N/A	✓
Outputs		
• Load voltage	V 4 Relay outputs External auxiliary voltage 0 ... 30 DC V 0 ... 230 AC	3 solid-state outputs through bus cable or external auxiliary voltage, switch-selectable
• Current carrying capacity ΣI_{max}		
- With external auxiliary voltage	A 1.5	0.3
- Without external auxiliary voltage	A —	0.2
Operating temperature	°C -20 ... +50	-20 ... +50
Enclosures		
Enclosure material	Thermoplast (polyamide), impact-resistant, black	Thermoplast (polyamide), impact-resistant, black
Light elements	Thermoplast (polycarbonate)	Thermoplast (polycarbonate)
Mounting		
• Horizontal (floor mounting, foot with 25 mm Ø pipe)	✓	✓
• Horizontal (single-hole mounting)	✓	—
• Vertical with bracket	✓	✓
Degree of protection		
• Light elements	IP54	IP65 (seal premounted with every module)
• Acoustic elements, AS-i adapter elements	IP54	IP65
Operating temperature	°C -20 ... +50	-20 ... +50
Connection		
• Conductor cross-sections	mm ² M3 screw terminal Max. 2.5	Spring-type terminals/M3 screw terminals Max. 2.5
• Tightening torque	Nm Max. 0.5	- / Max. 0.5

8WD4 Signaling Columns

8WD42 signaling columns, 50 mm diameter

Selection and ordering data

Version	Slow-action contacts for each pedal	SD	Article No.	Price per PU	PU (UNIT, SET, M)	PS*
Metal enclosures, degree of protection IP65						
 <p>3SE290.-.AA20 3SE291.-.AA20</p>	Momentary-contact foot switches, single pedal, non-latching M20 x 1.5 cable entry					
	• Without hood	1 NO + 1 NC ↻ 2	3SE2902-0AB20		1	1 unit
		2 NO + 2 NC ↻ 2	3SE2903-1AB20		1	1 unit
	• With hood	1 NO + 1 NC ↻ 2	3SE2902-0AA20		1	1 unit
	2 NO + 2 NC ↻ 2	3SE2903-1AA20		1	1 unit	
 <p>3SE2912-.AB20</p>	Momentary-contact foot switches, single pedal, latching M20 x 1.5 cable entry					
	• Without hood	1 NO + 1 NC ↻ 15	3SE2912-2AB20		1	1 unit
	• With hood	1 NO + 1 NC ↻ 15	3SE2912-2AA20		1	1 unit
 <p>3SE2932-.AA20</p>	Momentary-contact foot switches, two pedals, non-latching M25 x 1.5 cable entry					
	• Without hood	1 NO + 1 NC ↻ 5	3SE2932-0AB20		1	1 unit
		2 NO + 2 NC ↻ 5	3SE2932-1AB20		1	1 unit
	• With hood	1 NO + 1 NC ↻ 5	3SE2932-0AA20		1	1 unit
	2 NO + 2 NC ↻ 5	3SE2932-1AA20		1	1 unit	
 <p>3SE2924-3AA20</p>	Safety momentary-contact foot switches, non-latching, single pedal With hood M20 x 1.5 cable entry with interlocking function NO closes as momentary contact type NC opens with automatic latching (safety function)		2 NO + 2 NC ↻ 15	3SE2924-3AA20		1 1 unit
Plastic enclosures, degree of protection IP65						
 <p>3SE3902-4CA20 3SE3934-5CB20</p>	Momentary-contact pedal switches, 3 m cable		Microswitch			
	• Single pedal					
	- Without hood	1 CO contact	5	3SE3902-4CB20		1 1 unit
	- With hood	1 CO contact	5	3SE3902-4CA20		1 1 unit
	• Two pedals, without hood	2 x 1 CO	5	3SE3934-5CB20		1 1 unit
Accessories						
	Protection cover Single pedal foot switch for 3SE2912-2AA20	--	20	3SE3980-8M		1 1 unit
	Contact block, 6 A, Supersedes momentary-contact foot switch 3SE29.2-.A.20 and 3SE29.3-.A.20	2 NO + 2 NC	X	3SE3982-0K		1 1 unit
	Contact block, 16 A, Supersedes momentary-contact foot switch 3SE29.2-0A.20	1 NO + 1 NC	X	3SE3982-0L		1 1 unit
	Contact block, 16 A, Supersedes momentary-contact foot switch 3SE2924-3AA20	2 NO + 2 NC	X	3SE3982-7J		1 1 unit
	Contact block, 16 A, Supersedes momentary-contact foot switch 3SE2912-2A.20	1 NO + 1 NC	30	3SE3982-7L		1 1 unit

↻ Positive opening according to IEC 60947-5-1, Annex K.

8WD4 Signaling Columns

8WD42 signaling columns, 50 mm diameter

Version	Rated voltage	Color	SD	Article No.	Price per PU	PU (UNIT, SET, M)	PS*
	V		d				
Connection elements							
	Connection elements with cover For mounting on pipes, floors and angles Essential part for assembling the signaling columns		Black	2	8WD4208-0AA	1	1 unit
Mounting							
	Feet, single	Plastic, for mounting on pipes		2	8WD4308-0DB	1	1 unit
		Metal, for pipe lengths > 400 mm		2	8WD4308-0DC	1	1 unit
	Adjustable-angle feet For positioning in 7.5° increments ¹⁾	Plastic, for floor mounting (without pipe)		2	8WD4208-0DE	1	1 unit
		Plastic, for mounting on pipes, incl. rubber seal		2	8WD4408-0DF	1	1 unit
	Pipes, single	Length 100 mm		2	8WD4208-0EF	1	1 unit
		Length 150 mm		2	8WD4308-0EE	1	1 unit
		Length 250 mm		2	8WD4308-0EA	1	1 unit
		Length 400 mm		2	8WD4308-0EB	1	1 unit
		Length 1000 mm		2	8WD4308-0ED	1	1 unit
	Sockets for feet	Side cable outlet		2	8WD4308-0DD	1	1 unit
		Side cable outlet, with magnetic fixing ²⁾		2	8WD4308-0DE	1	1 unit
	Brackets for mounting with foot			2	8WD4408-0CC	1	1 unit
	Brackets for wall mounting (plastic)	Mounting without feet or pipe		2	8WD4208-0CD	1	1 unit
	Adapters for single-hole mounting	Mounting without feet and pipe, with M18 thread and fixing nut		2	8WD4208-0EH	1	1 unit
Lamps							
	Incandescent lamps, 5 W Base BA 15d	24 AC/DC	Clear	2	8WD4328-1XX	1	10 units
		115 AC	Clear	2	8WD4348-1XX	1	10 units
		230 AC	Clear	2	8WD4358-1XX	1	10 units
	LEDs Base BA 15d	24 AC/DC	Red	2	8WD4428-6XB	1	1 unit
			Green	2	8WD4428-6XC	1	1 unit
			Yellow	2	8WD4428-6XD	1	1 unit
			Clear	2	8WD4428-6XE	1	1 unit
			Blue	2	8WD4428-6XF	1	1 unit
		115 AC	Red	2	8WD4448-6XB	1	1 unit
			Green	2	8WD4448-6XC	1	1 unit
			Yellow	2	8WD4448-6XD	1	1 unit
			Clear	2	8WD4448-6XE	1	1 unit
			Blue	2	8WD4448-6XF	1	1 unit
		230 AC	Red	2	8WD4458-6XB	1	1 unit
			Green	2	8WD4458-6XC	1	1 unit
			Yellow	2	8WD4458-6XD	1	1 unit
			Clear	2	8WD4458-6XE	1	1 unit
			Blue	2	8WD4458-6XF	1	1 unit

For labeling panels see 8WD44, page 10/169.

¹⁾ Markings for 30°, 45°, 60° and 90°.

²⁾ For horizontal mounting, only 1 element is recommended.

8WD4 Signaling Columns

8WD44 signaling columns, 70 mm diameter

Overview

Features:

- Thermoplast enclosure, diameter 70 mm
- Advanced design and significantly improved illumination

- Fast and flexible connection using spring-type terminals
- Integrated degree of protection IP65
- Up to 5 elements can be mounted

Selection and ordering data

Version	Rated voltage	Color	DT	Order No.	PU (UNIT, SET, M)	PS	
V							
Acoustic elements¹⁾							
	Buzzer elements 85 dB, pulsating or continuous tone, adjustable by means of a wire jumper	24 AC/DC	Black	A	8WD44 20-0FA	1	1 unit
		115 AC		A	8WD44 40-0FA	1	1 unit
		230 AC		A	8WD44 50-0FA	1	1 unit
	Siren elements , multi-tone, 100 dB, 8 tones and volume are adjustable	24 AC/DC	Black	A	8WD44 20-0EA2	1	1 unit
		115 AC		A	8WD44 40-0EA2	1	1 unit
		230 AC		A	8WD44 50-0EA2	1	1 unit
	Siren elements 108 dB, IP40	24 DC	Black	A	8WD44 20-0EA	1	1 unit
	Light elements for incandescent lamps/LEDs, BA 15d bases²⁾						
		Continuous light elements	12 ... 230 AC/DC	Red	A	8WD44 00-1AB	1
			Green	A	8WD44 00-1AC	1	1 unit
			Yellow	A	8WD44 00-1AD	1	1 unit
			Clear	A	8WD44 00-1AE	1	1 unit
			Blue	A	8WD44 00-1AF	1	1 unit
Blinklight elements		24 AC/DC	Red	A	8WD44 20-1BB	1	1 unit
			Green	A	8WD44 20-1BC	1	1 unit
			Yellow	A	8WD44 20-1BD	1	1 unit
			Clear	A	8WD44 20-1BE	1	1 unit
			Blue	A	8WD44 20-1BF	1	1 unit
		115 AC	Red	A	8WD44 40-1BB	1	1 unit
			Green	A	8WD44 40-1BC	1	1 unit
			Yellow	A	8WD44 40-1BD	1	1 unit
			Clear	A	8WD44 40-1BE	1	1 unit
			Blue	A	8WD44 40-1BF	1	1 unit
230 AC	Red	A	8WD44 50-1BB	1	1 unit		
	Green	A	8WD44 50-1BC	1	1 unit		
	Yellow	A	8WD44 50-1BD	1	1 unit		
	Clear	A	8WD44 50-1BE	1	1 unit		
	Blue	A	8WD44 50-1BF	1	1 unit		
Light elements with integrated flash lamps³⁾							
	Flashlight elements with integrated electronic flash	24 DC	Red	A	8WD44 20-0CB	1	1 unit
			Green	A	8WD44 20-0CC	1	1 unit
			Yellow	A	8WD44 20-0CD	1	1 unit
			Clear	A	8WD44 20-0CE	1	1 unit
			Blue	A	8WD44 20-0CF	1	1 unit
	115 AC	Red	A	8WD44 40-0CB	1	1 unit	
		Green	D	8WD44 40-0CC	1	1 unit	
		Yellow	A	8WD44 40-0CD	1	1 unit	
		Clear	D	8WD44 40-0CE	1	1 unit	
		Blue	D	8WD44 40-0CF	1	1 unit	
	230 AC	Red	A	8WD44 50-0CB	1	1 unit	
		Green	A	8WD44 50-0CC	1	1 unit	
		Yellow	A	8WD44 50-0CD	1	1 unit	
		Clear	A	8WD44 50-0CE	1	1 unit	
		Blue	A	8WD44 50-0CF	1	1 unit	







¹⁾ One acoustic element can be mounted per signaling column. The cover is included in the scope of supply of the acoustic elements and fixed in place.

²⁾ The lamp is not included in the scope of supply. Please order separately.

³⁾ The lamp is included in the scope of supply.

8WD4 Signaling Columns

8WD44 signaling columns, 70 mm diameter

Version	Rated voltage	Color	DT	Order No.	PU (UNIT, SET, M)	PS								
V														
Light elements with integrated LED														
	Continuous light elements	24 AC/DC	Red	A	8WD44 20-5AB	1	1 unit							
			Green	A	8WD44 20-5AC	1	1 unit							
			Yellow	A	8WD44 20-5AD	1	1 unit							
			Clear	A	8WD44 20-5AE	1	1 unit							
			Blue	A	8WD44 20-5AF	1	1 unit							
		115 AC	Red	A	8WD44 40-5AB	1	1 unit							
			Green	A	8WD44 40-5AC	1	1 unit							
			Yellow	A	8WD44 40-5AD	1	1 unit							
			Clear	A	8WD44 40-5AE	1	1 unit							
			Blue	A	8WD44 40-5AF	1	1 unit							
		230 AC	Red	A	8WD44 50-5AB	1	1 unit							
			Green	A	8WD44 50-5AC	1	1 unit							
			Yellow	A	8WD44 50-5AD	1	1 unit							
			Clear	A	8WD44 50-5AE	1	1 unit							
			Blue	A	8WD44 50-5AF	1	1 unit							
	Blinklight elements	24 AC/DC	Red	A	8WD44 20-5BB	1	1 unit							
			Green	A	8WD44 20-5BC	1	1 unit							
			Yellow	A	8WD44 20-5BD	1	1 unit							
			Clear	X	8WD44 20-5BE	1	1 unit							
			Blue	A	8WD44 20-5BF	1	1 unit							
		115 AC	Red	A	8WD44 40-5BB	1	1 unit							
			Green	A	8WD44 40-5BC	1	1 unit							
			Yellow	A	8WD44 40-5BD	1	1 unit							
			Clear	A	8WD44 40-5BE	1	1 unit							
			Blue	A	8WD44 40-5BF	1	1 unit							
		230 AC	Red	A	8WD44 50-5BB	1	1 unit							
			Green	A	8WD44 50-5BC	1	1 unit							
			Yellow	A	8WD44 50-5BD	1	1 unit							
			Clear	A	8WD44 50-5BE	1	1 unit							
			Blue	A	8WD44 50-5BF	1	1 unit							
	Rotating light elements	24 AC/DC	Red	A	8WD44 20-5DB	1	1 unit							
			Green	A	8WD44 20-5DC	1	1 unit							
			Yellow	A	8WD44 20-5DD	1	1 unit							
Adapter elements for AS-Interface														
	AS-Interface adapter elements With/without external auxiliary voltage, switchable													
								• A/B technology	For 3 signaling elements 24 V DC	Black	A	8WD44 28-0BD	1	1 unit
								• Standard AS-i	For 4 signaling elements 24 V DC	Black	A	8WD44 28-0BE	1	1 unit
Connection elements¹⁾														
	Connection elements with cover			Black										
		Screw terminals												
		• For mounting on pipes			A	8WD44 08-0AA	1	1 unit						
		• For mounting on brackets and floors			A	8WD44 08-0AB	1	1 unit						
		Spring-type terminals												
		• For mounting on pipes			A	8WD44 08-0AD	1	1 unit						
• For mounting on brackets and floors			A	8WD44 08-0AE	1	1 unit								
Cover (replacement)			A	8WD44 08-0XA	1	1 unit								

¹⁾ The connection element with cover is an essential part for assembling the signaling columns.

8WD4 Signaling Columns

8WD44 signaling columns, 70 mm diameter

Version	DT	Order No.	PU (UNIT, SET, M)	PS		
Mounting						
	Foot with pipe	Plastic foot with pipe length 100 mm	A	8WD43 08-0DA	1	1 unit
	Feet, single	Plastic, for mounting on pipes	A	8WD43 08-0DB	1	1 unit
		Metal, for pipe lengths > 400 mm	A	8WD43 08-0DC	1	1 unit
	Adjustable-angle feet for positioning in 7.5° increments ¹⁾	Plastic, for mounting on pipes, incl. rubber seal	X	8WD44 08-0DF	1	1 unit
	Pipes, single	Length 100 mm	A	8WD42 08-0EF	1	1 unit
		Length 150 mm	A	8WD43 08-0EE	1	1 unit
		Length 250 mm	A	8WD43 08-0EA	1	1 unit
		Length 400 mm	A	8WD43 08-0EB	1	1 unit
		Length 1000 mm	A	8WD43 08-0ED	1	1 unit
	Sockets for feet	Side cable outlet (can also be used without feet)	A	8WD43 08-0DD	1	1 unit
		Side cable outlet, with magnetic fixing ²⁾	A	8WD43 08-0DE	1	1 unit
	Brackets for wall mounting (mounting without feet and pipe)	For single-sided mounting	A	8WD43 08-0CA	1	1 unit
		For double-sided mounting	A	8WD43 08-0CB	1	1 unit
	Brackets for mounting with foot		A	8WD44 08-0CC	1	1 unit
	Brackets for base mounting	Mounting without feet and pipe	A	8WD44 08-0CD	1	1 unit
	Adapter for mounting on pipes according to NPT	Mounting on pipes, Ø 25 mm, with NPT 1/2" thread	A	8WD43 08-0DF	1	1 unit

¹⁾ Markings for 30°, 45°, 60° and 90°.



²⁾ For horizontal mounting, only 1 element is recommended.

Note:

For mounting and configuring aid see the publication "Versatile, robust, communication-capable: SIRIUS signaling columns and integrated signal lamps", Order No. E20001-A670-P305.

8WD4 Signaling Columns

8WD44 signaling columns, 70 mm diameter

Version	Rated voltage	Color	DT	Order No.	PU (UNIT, SET, M)	PS	
V							
Lamps							
	Incandescent lamps, 5 W						
	Base BA 15d	24 AC/DC	A	8WD43 28-1XX	1	10 units	
		115 AC	A	8WD43 48-1XX	1	10 units	
		230 AC	A	8WD43 58-1XX	1	10 units	
	LEDs						
	Base BA 15d	24 AC/DC	Red	A	8WD44 28-6XB	1	1 unit
			Green	A	8WD44 28-6XC	1	1 unit
			Yellow	A	8WD44 28-6XD	1	1 unit
			Clear	A	8WD44 28-6XE	1	1 unit
			Blue	A	8WD44 28-6XF	1	1 unit
		115 AC	Red	A	8WD44 48-6XB	1	1 unit
			Green	A	8WD44 48-6XC	1	1 unit
			Yellow	A	8WD44 48-6XD	1	1 unit
			Clear	A	8WD44 48-6XE	1	1 unit
			Blue	A	8WD44 48-6XF	1	1 unit
		230 AC	Red	A	8WD44 58-6XB	1	1 unit
			Green	A	8WD44 58-6XC	1	1 unit
			Yellow	A	8WD44 58-6XD	1	1 unit
			Clear	A	8WD44 58-6XE	1	1 unit
Blue			A	8WD44 58-6XF	1	1 unit	
Inscriptions							
	Labeling panels		A	8WD44 08-0FA	1	1 unit	
<p>With fixing accessories for mounting on pipe \varnothing 25 mm</p> <p>Inscription area/ step 50 mm x 140 mm</p> <p>Suitable for standard labels, e.g.</p> <ul style="list-style-type: none"> • Zweckform 3425 • Herma 4457 							

8WD53 Beacons

8WD53 beacons, 70 mm diameter

Overview



Integrated signal lamps

Design

Features:

- Thermoplast enclosures, diameter 70 mm
- Degree of protection IP65
- Rated voltage 24 V, 115 V, 230 V AC/DC
- Ambient temperature -20 to +50 °C, incandescent lamp up to 60 °C

The special shape of the integrated signal lamps means that the light is emitted optimally in every direction (to the sides and upwards). Continuous lights (with incandescent lamp or LED) and single-flash lights are available in five colors.





The LED versions of the integrated signal lamps offer a considerably longer endurance than the incandescent lamp versions.

All integrated signal lamps have a high degree of protection IP65 and are made of a material highly resistant to impact.

Mounting

8WD53 integrated signal lamps can be mounted directly at any point of the machine for the purpose of giving visual signals. They are mounted by means of a PG29 screw base with nut.

Selection and ordering data

Version	Rated voltage	Color	DT	Order No.	Price per PU	PU (UNIT, SET, M)	PS	PG		
V										
Luminaires for incandescent lamps/LED, BA 15d base										
	Continuous light ¹⁾	12 ... 230 AC/DC	Red	A	8WD53 00-1AB		1	1 unit	41J	
			Green	A	8WD53 00-1AC		1	1 unit	41J	
			Yellow	A	8WD53 00-1AD		1	1 unit	41J	
			Clear	A	8WD53 00-1AE		1	1 unit	41J	
			Blue	A	8WD53 00-1AF		1	1 unit	41J	
Luminaires with integrated flash lamp										
  	Single-flash light with integrated electronic flash	24 AC/DC	Red	A	8WD53 20-0CB		1	1 unit	41J	
			Green	D	8WD53 20-0CC		1	1 unit	41J	
			Yellow	A	8WD53 20-0CD		1	1 unit	41J	
			Clear	A	8WD53 20-0CE		1	1 unit	41J	
			Blue	A	8WD53 20-0CF		1	1 unit	41J	
			115 AC	Red	A	8WD53 40-0CB		1	1 unit	41J
				Green	D	8WD53 40-0CC		1	1 unit	41J
				Yellow	D	8WD53 40-0CD		1	1 unit	41J
				Clear	D	8WD53 40-0CE		1	1 unit	41J
			230 AC	Blue	D	8WD53 40-0CF		1	1 unit	41J
				Red	A	8WD53 50-0CB		1	1 unit	41J
				Green	D	8WD53 50-0CC		1	1 unit	41J
Yellow	A	8WD53 50-0CD			1	1 unit	41J			
	Continuous light	24 AC/DC	Red	A	8WD53 20-5AB		1	1 unit	41J	
			Green	A	8WD53 20-5AC		1	1 unit	41J	
			Yellow	A	8WD53 20-5AD		1	1 unit	41J	
			Blinklight lamps	Red	A	8WD53 20-5BB		1	1 unit	41J
Green	D	8WD53 20-5BC			1	1 unit	41J			
Yellow	A	8WD53 20-5BD			1	1 unit	41J			
Rotating light	Red	A	8WD53 20-5DB		1	1 unit	41J			
	Green	A	8WD53 20-5DC		1	1 unit	41J			
	Yellow	A	8WD53 20-5DD		1	1 unit	41J			

For incandescent lamps and LEDs see "Signaling Columns" page 10/169

¹⁾ Lamp not included in scope of supply. Please order separately.

8WD4 Signaling Columns

Dimension drawings

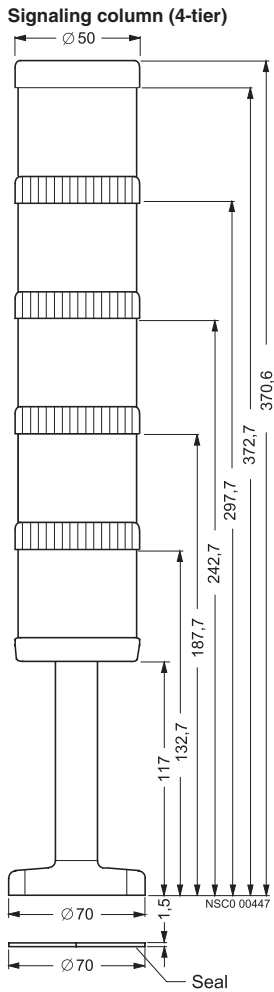

Foot

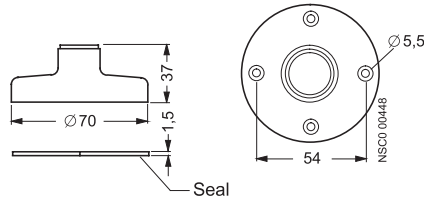

Bracket for wall mounting

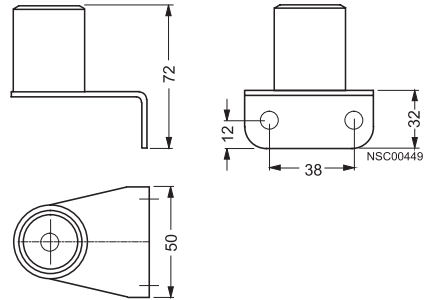

Adapter for single-hole mounting

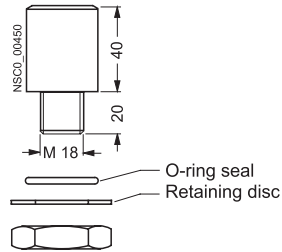

Connection element

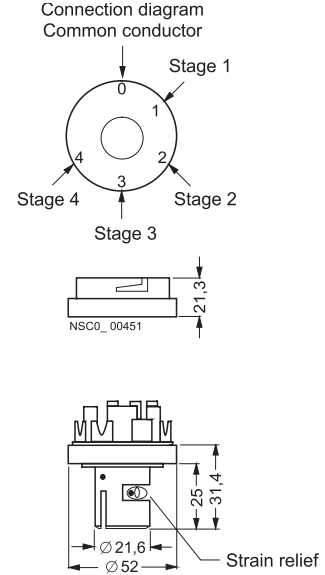

8WD4 Signaling Columns

Dimension drawings

Dimension drawings

Signaling column (5-tier)

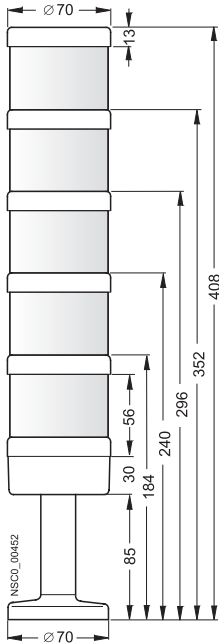

Connection diagrams

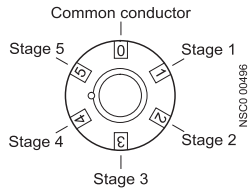

conventional

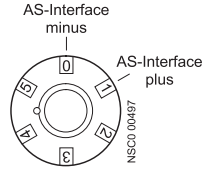

with AS-Interface,
without external auxiliary
voltage

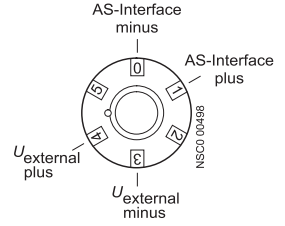

with external auxiliary voltage

Connection element and cover for mounting on pipes

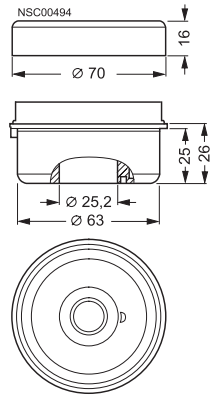

Connection element and cover for mounting on floor/bracket

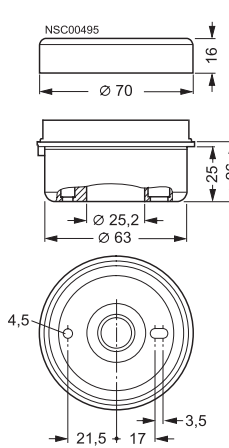

Foot with pipe

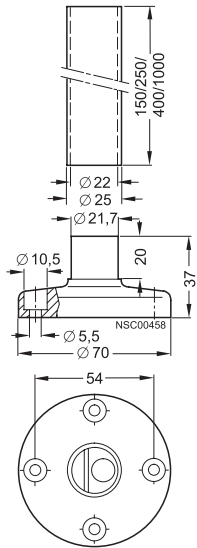

Bracket for single-sided mounting

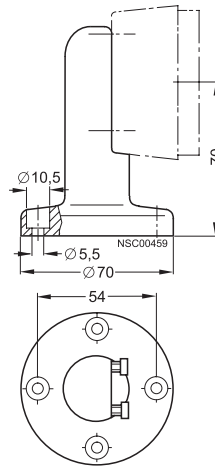

Bracket for double-sided mounting

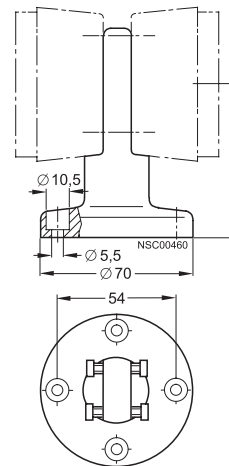

8WD53 Beacons

Dimension drawings

Dimension drawings

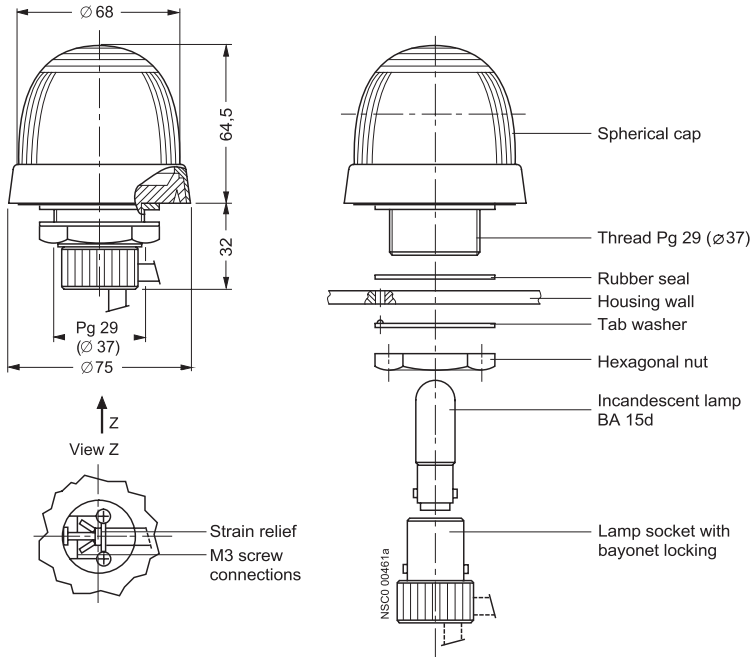

Class 50 Standard Duty Pushbutton Stations

General

Features

- Snap In Legend Inserts
- Flush and Surface Mounted Types
- Convertible Selector
- Double Break Contacts
- Dual Voltage Pilot Light with Snap In Lens
- Conversion Kits
- UL Listed File #E22655
- CSA Certified File #LR6535

Application

Standard duty control stations are used with magnetic controllers to control the starting, stopping, reversing or speed of applicable motors.

Stations are assembled of one, two or three push button, selector switch or pilot light units in a variety of combinations to provide compact control units for remote control of magnetic starters and contactors.

Station enclosures are available in Type 1 surface mounted, 1B flush plate mounted and 4 watertight.

Features

Type 1 surface mounted bases are constructed of 14 gauge sheet steel, primed and finished in baked gray enamel. The base is predrilled to receive a variety of contact blocks, pilot lights and accessory devices. Covers are of 20 gauge sheet steel, wrap-around construction, primed and finished in baked gray enamel. Siemens Type 4 watertight heavy duty push button stations are supplied with a provision to padlock the stop button in the depressed position. Enclosures are predrilled and tapped for 3/4" conduit.

Contact blocks have double break, fine silver contacts with a NEMA B600 rating. Type 4 stations have a NEMA A600 rating.

The pilot light assembly is dual voltage with clearly marked pressure type terminals for 120 volt or 240 volt connection.

The lens of the pilot light snaps into the cover and is available in both red and green.

Push buttons are equipped with an operator into which a selected legend insert is snapped. Legend inserts are molded thermoplastic and come in a wide variety of legends and colors.

The selector switch operator can be instantly set for two or three positions at any time.

Mushroom Head

50ZMH mounts on any standard push button operator. The Mushroom Head is red molded thermoplastic, 1 1/2" in diameter, and provides a large operator for emergency stop or similar applications.

Mechanical Interlock

50ZAM is a base mounted zinc plate, dichromate dipped, steel assembly. When mounted in conjunction with Duplex Contact Block 50ZAC3 (one NO and one NO) the interlock prevents one contact from being closed while the other contact is closed.

Padlock Attachment Kit

50ZAL can be mounted to any Type 1 surface mounted station by the lower screw which fastens the cover to the station base. Made of heavy steel, chrome plated, the attachment provides for the padlocking of a push button in the depressed position or a selector switch in any position. When used with a push button operator, raised Legend Insert D53493003 (Red Stop) must be used.

Electrical Ratings

NEMA AC Ratings 50/60Hz

Nema B600 5 Continuous Amps

Volts	Make	Break
120	30	3
240	15	1.5
480	7.5	0.75
600	6	0.6
VA	3600	360

Ordering Information

- Legend Inserts [see page 10/181](#).
- Accessories [see page 10/181](#).



**2 Push Buttons
Surface Mounting, NEMA 1**



**2 Push Buttons
Flush Mounting, NEMA 1B**



**1 Push Button
Surface Mounting**



**1 Selector Switch
Flush Mounting**



**2 Push Buttons
1 Selector Switch**





**1 Pilot Light
2 Push Buttons**

Class 50 Standard Duty Pushbutton Stations

5A 600V AC NEMA B600



Selection and ordering data

	Operator identification	Degree of protection	Contacts / voltage	Number of command points	Order No.	Packs
						Unit
 <p>1 unit surface mount-momentary pushbutton</p>	A = Momentary flush pushbutton green, surface, label "START"	NEMA 1	1NO - 1NC with common jumper (50ZAC1)	1	50AA3D	1
	A = Momentary flush pushbutton red, surface, label "STOP"	NEMA 1	1NO - 1NC with common jumper (50ZAC1)	1	50AA3E	1
	A = Momentary raised pushbutton red, surface, label "STOP"	NEMA 1	1NO - 1NC with common jumper (50ZAC1)	1	50AA3F	1
	A = Momentary mushroom head red, surface, label "STOP"	NEMA 1	1NO - 1NC with common jumper (50ZAC1)	1	50AA3G	1
	A = Momentary flush pushbutton less insert, surface	NEMA 1	1NO - 1NC with common jumper (50ZAC1)	1	50AA3A	1
	A = 3 position selector switch, surface, label "HAND-OFF-AUTO"	NEMA 1	2 NO 2SPST (50ZAC8)	1	50AA3C3	1
	A = 2 position selector switch, surface, label "Off-On"	NEMA 1	2 NO 2SPST (50ZAC8)	1	50AA3C6	1
	A = 2/3 selector switch, surface, multiple legends	NEMA 1	2 NO 2SPST (50ZAC8)	1	50AA3B9	1
	A = Indicator light, red, surface	NEMA 1	120/240V dual voltage 120PSB lamp	1	50BA3Y	1
	A = Indicator light, green, surface	NEMA 1	120/240V dual voltage 120PSB lamp	1	50BA3Z	1
A = Indicator light, less lens, surface	NEMA 1	120/240V dual voltage 120PSB lamp	1	50BA32	1	
 <p>1 unit flush mount-momentary pushbutton</p>	A = Momentary flush pushbutton green, flush, label "START"	NEMA 1B	1NO - 1NC with common jumper (50ZAC1)	1	50AA2D	1
	A = Momentary flush pushbutton red, flush, label "STOP"	NEMA 1B	1NO - 1NC with common jumper (50ZAC1)	1	50AA2E	1
	A = Momentary raised pushbutton red, flush, label "STOP"	NEMA 1B	1NO - 1NC with common jumper (50ZAC1)	1	50AA2F	1
	A = Momentary flush pushbutton less insert, flush	NEMA 1B	1NO - 1NC with common jumper (50ZAC1)	1	50AA2A	1
	A = Momentary flush pushbutton less insert, flush, chrome plate	NEMA 1B	1NO - 1NC with common jumper (50ZAC1)	1	50AA6A	1
	A = 3 position selector switch, flush, label "HAND-OFF-AUTO"	NEMA 1B	2 NO 2SPST (50ZAC8)	1	50AA2C3	1
	A = 3 position selector switch, flush, label "Off-On"	NEMA 1B	2 NO 2SPST (50ZAC8)	1	50AA2C6	1
	A = 2/3 selector switch, multiple legends, flush	NEMA 1B	2 NO 2SPST (50ZAC8)	1	50AA2B9	1
	A = 2/3 selector switch, multiple legends, chrome plate, flush	NEMA 1B	2 NO 2SPST (50ZAC8)	1	50AA6B9	1
	A = Indicator light, red, flush	NEMA 1B	120/240V dual voltage	1	50BA2Y	1
A = Indicator light, green, flush	NEMA 1B	120/240V dual voltage	1	50BA2Z	1	
A = Indicator light, less lens, flush	NEMA 1B	120/240V dual voltage	1	50BA22	1	
A = Indicator light, less lens, chrome plate, flush	NEMA 1B	120PSB lamp	1	50BA62	1	
 <p>2 unit surface mount-momentary pushbutton</p>	B = Momentary pushbutton green, surface, label "START"	NEMA 1	1NO, 1NC (50ZAC2)	2	50CA3DE	1
	A = Momentary pushbutton red, surface, label "STOP"					
	B = Momentary pushbutton green, surface, label "START"	NEMA 1	1NO, 1NC (50ZAC2)	2	50CA3DF	1
	A = Momentary raised pushbutton red, surface, label "STOP"					
	B = Momentary pushbutton green, surface, label "START"	NEMA 1	1NO, 1NC (50ZAC2)	2	50CA3DG	1
	A = Momentary mushroom head pushbutton red, surface, label "STOP"					
	B = Momentary pushbutton, less insert, surface	NEMA 1	1NO, 1NC (50ZAC2)	2	50CA3AA	1
	A = Momentary pushbutton, less insert, surface					
B = Momentary pushbutton, surface, label "FORWARD"	NEMA 1	2 NO (50ZAC3)	2	50DA3KL	1	
A = Momentary pushbutton, surface, label "REVERSE"						

Class 50 Standard Duty Pushbutton Stations

5A 600V AC NEMA B600

Selection and ordering data

	Operator identification	Degree of protection	Contacts / voltage	Number of command points	Order No.	Packs
						Unit
<p>2 unit surface mount-momentary pushbutton</p> 	B = Momentary pushbutton, surface, label "OPEN" A = Momentary pushbutton, surface, label "CLOSE"	NEMA 1	2 NO (50ZAC3)	2	50DA3HJ	1
	B = Momentary pushbutton, surface, label "UP" A = Momentary pushbutton, surface, label "DOWN"	NEMA 1	2 NO (50ZAC3)	2	50DA3NP	1
	B = Momentary pushbutton, surface, less insert A = Momentary pushbutton, surface, less insert	NEMA 1	2 NO (50ZAC3)	2	50DA3AA	1
	B = Momentary pushbutton, surface, label "FORWARD" A = Momentary pushbutton, surface, label "REVERSE"	NEMA 1	2 NO mechanically interlocked (50ZA3C w/ 50ZAM)	2	50RA3KL	1
	B = Momentary pushbutton, surface, label "OPEN" A = Momentary pushbutton, surface, label "CLOSE"	NEMA 1	2 NO mechanically interlocked (50ZA3C w/ 50ZAM)	2	50RA3HJ	1
	B = Momentary pushbutton, surface, label "UP" A = Momentary pushbutton, surface, label "DOWN"	NEMA 1	2 NO mechanically interlocked (50ZA3C w/ 50ZAM)	2	50RA3NP	1
	B = Momentary pushbutton, surface, label "ON" A = Momentary pushbutton, surface, label "OFF"	NEMA 1	2 NO mechanically interlocked (50ZA3C w/ 50ZAM)	2	50RA334	1
	B = Momentary pushbutton, less insert surface A = Momentary pushbutton, less insert, surface	NEMA 1	2 NO mechanically interlocked (50ZA3C w/ 50ZAM)	2	50RA3AA	1
	B = Momentary pushbutton, surface, label "FORWARD" A = Momentary pushbutton, surface, label "REVERSE"	NEMA 1	2 NO, 2 NC (2 - 50ZAC2)	2	50EA3KL	1
	B = Momentary pushbutton, surface, label "OPEN" A = Momentary pushbutton, surface, label "CLOSE"	NEMA 1	2 NO, 2 NC (2 - 50ZAC2)	2	50EA3HJ	1
	B = Momentary pushbutton, surface, label "UP" A = Momentary pushbutton, surface, label "DOWN"	NEMA 1	2 NO, 2 NC (2 - 50ZAC2)	2	50EA3NP	1
	B = Momentary pushbutton, surface, label "ON" A = Momentary pushbutton, surface, label "OFF"	NEMA 1	2 NO, 2 NC (2 - 50ZAC2)	2	50EA334	1
	B = Momentary pushbutton, surface, less insert A = Momentary pushbutton, surface, less insert	NEMA 1	2 NO, 2 NC (2 - 50ZAC2)	2	50EA3AA	1
	<p>2 unit flush mount-momentary pushbutton</p> 	B = Momentary pushbutton green, flush, label "START" A = Momentary pushbutton red, flush, label "STOP"	NEMA 1B	1NO, 1NC (50ZAC2)	2	50CA2DE
B = Momentary pushbutton, less insert, flush A = Momentary pushbutton, less insert, flush		NEMA 1B	1NO, 1NC (50ZAC2)	2	50CA2AA	1
B = Momentary pushbutton green, flush, label "START" A = Momentary raised pushbutton red, flush, label "STOP"		NEMA 1B	1NO, 1NC (50ZAC2)	2	50CA2DF	1
B = Momentary pushbutton green, flush, label "START" A = Momentary mushroom head pushbutton red, flush, label "STOP"		NEMA 1B	1NO, 1NC (50ZAC2)	2	50CA2DG	1
B = Momentary pushbutton, less insert, flush A = Momentary pushbutton, less insert, flush		NEMA 1B	1NO, 1NC (50ZAC2)	2	50CA6AA	1

Class 50 Standard Duty Pushbutton Stations

5A 600V AC NEMA A600

Selection and ordering data

	Operator identification	Degree of protection	Contacts / voltage	Number of command points	Order No.	Packs
						Unit
2 unit flush mount-momentary pushbutton	B = Momentary pushbutton, flush, label "FORWARD" A = Momentary pushbutton, flush, label "REVERSE"	NEMA 1B	2 NO (50ZAC3)	2	50DA2KL	1
	B = Momentary pushbutton, flush, label "OPEN" A = Momentary pushbutton, flush, label "CLOSE"	NEMA 1B	2 NO (50ZAC3)	2	50DA2HJ	1
	B = Momentary pushbutton, flush, label "UP" A = Momentary pushbutton, flush, label "DOWN"	NEMA 1B	2 NO (50ZAC3)	2	50DA2NP	1
	B = Momentary pushbutton, less insert, flush A = Momentary pushbutton, less insert, flush	NEMA 1B	2 NO (50ZAC3)	2	50DA2AA	1
	B = Momentary pushbutton, less insert, chrome plate, flush A = Momentary pushbutton, less insert, chrome plate, flush	NEMA 1B	2 NO (50ZAC3)	2	50DA6AA	1
	B = Momentary pushbutton, flush, label "FORWARD" A = Momentary pushbutton, flush, label "REVERSE"	NEMA 1B	2 NO mechanically interlocked (50ZA3C w/ 50ZAM)	2	50RA2KL	1
	B = Momentary pushbutton, flush, label "OPEN" A = Momentary pushbutton, flush, label "CLOSE"	NEMA 1B	2 NO mechanically interlocked (50ZA3C w/ 50ZAM)	2	50RA2HJ	1
	B = Momentary pushbutton, flush, label "UP" A = Momentary pushbutton, flush, label "DOWN"	NEMA 1B	2 NO mechanically interlocked (50ZA3C w/ 50ZAM)	2	50RA2NP	1
	B = Momentary pushbutton, flush, label "ON" A = Momentary pushbutton, flush, label "OFF"	NEMA 1B	2 NO mechanically interlocked (50ZA3C w/ 50ZAM)	2	50RA234	1
	B = Momentary pushbutton, less insert, flush A = Momentary pushbutton, less insert, flush	NEMA 1B	2 NO mechanically interlocked (50ZA3C w/ 50ZAM)	2	50RA2AA	1
	B = Momentary pushbutton, less insert, chrome plate, flush A = Momentary pushbutton, less insert, chrome plate, flush	NEMA 1B	2 NO mechanically interlocked (50ZA3C w/ 50ZAM)	2	50RA6AA	1
	B = Momentary pushbutton, flush, label "FORWARD" A = Momentary pushbutton, flush, label "REVERSE"	NEMA 1B	2 NO, 2 NC (2 - 50ZAC2)	2	50EA2KL	1
	B = Momentary pushbutton, flush, label "OPEN" A = Momentary pushbutton, flush, label "CLOSE"	NEMA 1B	2 NO, 2 NC (2 - 50ZAC2)	2	50EA2HJ	1
	B = Momentary pushbutton, flush, label "UP" A = Momentary pushbutton, flush, label "DOWN"	NEMA 1B	2 NO, 2 NC (2 - 50ZAC2)	2	50EA2NP	1
	B = Momentary pushbutton, flush, label "ON" A = Momentary pushbutton, flush, label "OFF"	NEMA 1B	2 NO, 2 NC (2 - 50ZAC2)	2	50EA234	1
	B = Momentary pushbutton, less insert, flush A = Momentary pushbutton, less insert, flush	NEMA 1B	2 NO, 2 NC (2 - 50ZAC2)	2	50EA2AA	1
	B = Momentary pushbutton, less insert, chrome plate, flush A = Momentary pushbutton, less insert, chrome plate, flush	NEMA 1B	2 NO, 2 NC (2 - 50ZAC2)	2	50EA6AA	1

Class 50 Standard Duty Pushbutton Stations

5A 600V AC NEMA B600

Selection and ordering data

	Operator identification	Degree of protection	Contacts / voltage	Number of command points	Order No.	Packs
						Unit
2 unit surface mount-momentary pushbutton and selector switch	B = Momentary pushbutton green, surface, label "START"	NEMA 1	1NO, 1NC (50ZAC1)	2	50FA3DC3	1
	A = Maintained selector switch, surface, label "HAND-OFF-AUTO"		2 NO 2SPDT w/ common jumper (50ZAC8)			
	B = Momentary pushbutton less insert, surface	NEMA 1	1NO, 1NC (50ZAC1)	2	50FA3AB9	1
	A = Maintained selector switch, multiple legends, surface		2 NO 2SPDT w/ common jumper (50ZAC8)			
2 unit surface mount-momentary pushbutton and indicator light	B = Indicator light, red, surface	NEMA 1	120/240V dual voltage (120PSB lamp)	2	50HA3YC3	1
	A = Maintained selector switch, surface, label "HAND-OFF-AUTO"		2 NO 2SPDT w/ common jumper (50ZAC8)			
	B = Indicator light, red, surface	NEMA 1	120/240V dual voltage (120PSB lamp)	2	50HA32B9	1
	A = Maintained selector switch, multiple legends, surface		2 NO 2SPDT w/ common jumper (50ZAC8)			
2 unit surface mount-momentary pushbutton and indicator light	B = Indicator light, green, surface	NEMA 1	120/240V dual voltage (120PSB lamp)	2	50GA3ZY	1
	A = Indicator light, red, surface					
	B = Indicator light, less lens, surface	NEMA 1	120/240V dual voltage (120PSB lamp)	2	50GA322	1
	A = Indicator light, less lens, surface					
2 unit flush mount-momentary pushbutton and selector switch	B = Momentary pushbutton green, flush, label "START"	NEMA 1B	1NO, 1NC (50ZAC1)	2	50FA2DC3	1
	A = Maintained selector switch, flush, label "HAND-OFF-AUTO"		2 NO 2SPDT w/ common jumper (50ZAC8)			
	B = Momentary pushbutton less insert, flush	NEMA 1B	1NO, 1NC (50ZAC1)	2	50FA2AB9	1
	A = Maintained selector switch, multiple legends, flush		2 NO 2SPDT w/ common jumper (50ZAC8)			
	B = Momentary pushbutton less insert chrome plate, flush	NEMA 1B	1NO, 1NC (50ZAC1)	2	50FA6AB9	1
	A = Maintained selector switch, multiple legends, flush		2 NO 2SPDT w/ common jumper (50ZAC8)			
	B = Indicator light, red, flush	NEMA 1B	120/240V dual voltage (120PSB lamp)	2	50HA2YC3	1
	A = Maintained selector switch, flush, label "HAND-OFF-AUTO"		2 NO 2SPDT w/ common jumper (50ZAC8)			
	B = Indicator light, less lens, flush	NEMA 1B	120/240V dual voltage (120PSB lamp)	2	50HA22B9	1
	A = Maintained selector switch, multiple legends, flush		2 NO 2SPDT w/ common jumper (50ZAC8)			
	B = Indicator light, less lens, chrome plate, flush	NEMA 1B	120/240V dual voltage (120PSB lamp)	2	50HA62B9	1
	A = Maintained selector switch, multiple legends, flush		2 NO 2SPDT w/ common jumper (50ZAC8)			
2 unit flush mount-momentary pushbutton and indicator light	B = Indicator light, green, flush	NEMA 1B	120/240V dual voltage (120PSB lamp)	2	50GA2ZY	1
	A = Indicator light, red, flush					
	B = Indicator light, less lens, flush	NEMA 1B	120/240V dual voltage (120PSB lamp)	2	50GA222	1
	A = Indicator light, less lens, flush					
2 unit flush mount-momentary pushbutton and indicator light	B = Indicator light, less lens, chrome plate, flush	NEMA 1B	120/240V dual voltage (120PSB lamp)	2	50GA622	1
	A = Indicator light, less lens, chrome plate, flush					
	C = Momentary pushbutton, surface, label "FORWARD"	NEMA 1	2 NO, 2 NC (2 - 50ZAC2)	3	50MA3KLE	1
	B = Momentary pushbutton, surface, label "REVERSE"		1NO - 1NC with common jumper (50ZAC1)			
3 unit surface mount-momentary pushbutton	A = Momentary pushbutton, surface, label "STOP"					
	C = Momentary pushbutton, surface, label "UP"	NEMA 1	2 NO, 2 NC (2 - 50ZAC2)	3	50MA3NPE	1
	B = Momentary pushbutton, surface, label "DOWN"		1NO - 1NC with common jumper (50ZAC1)			
	A = Momentary pushbutton, surface, label "STOP"					
3 unit surface mount-momentary pushbutton	C = Momentary pushbutton, surface, label "OPEN"	NEMA 1	2 NO, 2 NC (2 - 50ZAC2)	3	50MA3HJE	1
	B = Momentary pushbutton, surface, label "CLOSE"		1NO - 1NC with common jumper (50ZAC1)			
	A = Momentary pushbutton, surface, label "STOP"					

Class 50 Standard Duty Pushbutton Stations

5A 600V AC NEMA B600



Selection and ordering data

	Operator identification	Degree of protection	Contacts / voltage	Number of command points	Order No.	Packs
						Unit
3 unit surface mount-momentary pushbutton	C = Momentary pushbutton, surface, label "FAST"	NEMA 1	2 NO, 2 NC (2 - 50ZAC2) 1NO - 1NC with common jumper (50ZAC1)	3	50MA3TUE	1
	B = Momentary pushbutton, surface, label "SLOW"					
	A = Momentary pushbutton, surface, label "STOP"					
	C = Momentary pushbutton, surface, label "START"	NEMA 1	2 NO, 2 NC (2 - 50ZAC2) 1NO - 1NC with common jumper (50ZAC1)	3	50MA3DME	1
	B = Momentary pushbutton, surface, label "JOG"					
	A = Momentary pushbutton, surface, label "STOP"					
	C = Momentary pushbutton, surface, label less insert	NEMA 1	2 NO, 2 NC (2 - 50ZAC2) 1NO - 1NC with common jumper (50ZAC1)	3	50MA3AAA	1
	B = Momentary pushbutton, surface, label less insert					
	A = Momentary pushbutton, surface, label less insert					
3 unit surface mount-momentary pushbutton and selector switch	C = Momentary pushbutton, surface, label "START"	NEMA 1	1 NO, 1 NC (50ZAC2) 2 NO, 2 SPST with common jumper (50ZAC8)	3	50LA3DEC3	1
	B = Momentary pushbutton, surface, label "STOP"					
	A = Maintained selector switch, surface, label "HAND-OFF-AUTO"					
	C = Momentary pushbutton, less insert, surface	NEMA 1	1 NO, 1 NC (50ZAC2) 2 NO, 2 SPST with common jumper (50ZAC8)	3	50LA3AAB9	1
	B = Momentary pushbutton, less insert, surface					
	A = Maintained selector switch, multiple legends, surface					
3 unit surface mount-momentary pushbutton and indicator light	C = Indicator light, red, surface	NEMA 1	120/240V dual voltage (120PSB lamp) 1 NO, 1 NC (50ZAC2)	3	50JA3YDE	1
	B = Momentary pushbutton, surface, label "START"					
	A = Momentary pushbutton, surface, label "STOP"					
	C = Indicator light, green, surface	NEMA 1	120/240V dual voltage (120PSB lamp) 1 NO, 1 NC (50ZAC2)	3	50JA3ZDE	1
	B = Momentary pushbutton, surface, label "START"					
	A = Momentary pushbutton, surface, label "STOP"					
	C = Indicator light, less lens, surface	NEMA 1	120/240V dual voltage (120PSB lamp) 1 NO, 1 NC (50ZAC2)	3	50JA32AA	1
	B = Momentary pushbutton, less insert, surface					
	A = Momentary pushbutton, less insert, surface					
	C = Indicator light, green, surface	NEMA 1	120/240V dual voltage (120PSB lamp) 2 NO, 2 SPST with common jumper (50ZAC8)	3	50NA3ZYC3	1
	B = Indicator light, red, surface					
	A = Maintained selector switch, surface, label "HAND-OFF-AUTO"					
	C = Indicator light, less lens, surface	NEMA 1	120/240V dual voltage (120PSB lamp) 2 NO, 2 SPST with common jumper (50ZAC8)	3	50NA322B9	1
	B = Indicator light, less lens, surface					
	A = Maintained selector switch, multiple legends, surface					

Class 50 Standard Duty Pushbutton Stations

Heavy duty - 10A 600V AC NEMA A600

Selection and ordering data

	Operator identification	Degree of protection	Contacts / voltage	Number of command points	Order No.	Packs
						Unit
	A = Momentary pushbutton green, surface, label "START"	NEMA 4	1NO - 1NC	1	50HA1E1	1
	A = Momentary pushbutton red, surface, label "STOP"	NEMA 4	1NO - 1NC	1	50HA1E2	1
	A = Momentary pushbutton green, surface, label "RESET"	NEMA 4	1NO - 1NC	1	50HA1E4	1
	A = Momentary pushbutton green, surface, label "JOG"	NEMA 4	1NO - 1NC	1	50HA1E5	1
	A = Maintained selector switch, surface, label "SAFE-RUN"	NEMA 4	1NO - 1NC	1	50HA1E6	1
	A = Maintained selector switch, surface, label "OFF-ON"	NEMA 4	1NO - 1NC	1	50HA1E7	1
	A = Maintained selector switch, surface, label "JOG-RUN"	NEMA 4	1NO - 1NC	1	50HA1E8	1
	A = Maintained selector switch, surface, label "HAND-OFF-AUTO"	NEMA 4	1NO - 1NC	1	50HA1E9	1
		B = Momentary pushbutton green, surface, label "START"	NEMA 4	1NO - 1NC	2	50HA2E1
A = Momentary pushbutton red, surface, label "STOP"			1NO - 1NC			
B = Momentary pushbutton green, surface, label "FORWARD"		NEMA 4	1NO - 1NC	2	50HA2E2	1
A = Momentary pushbutton red, surface, label "REVERSE"			1NO - 1NC			
B = Momentary pushbutton green, surface, label "UP"		NEMA 4	1NO - 1NC	2	50HA2E3	1
A = Momentary pushbutton red, surface, label "DOWN"			1NO - 1NC			
B = Momentary pushbutton green, surface, label "OPEN"		NEMA 4	1NO - 1NC	2	50HA2E4	1
A = Momentary pushbutton red, surface, label "CLOSE"			1NO - 1NC			
B = Momentary pushbutton green, surface, label "FAST"		NEMA 4	1NO - 1NC	2	50HA2E5	1
A = Momentary pushbutton red, surface, label "SLOW"			1NO - 1NC			
	C = Momentary pushbutton green, surface, label "FORWARD"	NEMA 4	1NO - 1NC	3	50HA3E1	1
	B = Momentary pushbutton green, surface, label "REVERSE"		1NO - 1NC			
	A = Momentary pushbutton red, surface, label "STOP"		1NO - 1NC			
	C = Momentary pushbutton green, surface, label "UP"	NEMA 4	1NO - 1NC	3	50HA3E2	1
	B = Momentary pushbutton green, surface, label "DOWN"		1NO - 1NC			
	A = Momentary pushbutton red, surface, label "STOP"		1NO - 1NC			
	C = Momentary pushbutton green, surface, label "OPEN"	NEMA 4	1NO - 1NC	3	50HA3E3	1
	B = Momentary pushbutton green, surface, label "CLOSE"		1NO - 1NC			
	A = Momentary pushbutton red, surface, label "STOP"		1NO - 1NC			
	C = Momentary pushbutton green, surface, label "START"	NEMA 4	1NO - 1NC	3	50HA3E9	1
	B = Momentary pushbutton green, surface, label "JOG"		1NO - 1NC			
	A = Momentary pushbutton red, surface, label "STOP"		1NO - 1NC			
	C = Momentary pushbutton green, surface, label "FAST"	NEMA 4	1NO - 1NC	3	50HA3E4	1
	B = Momentary pushbutton green, surface, label "SLOW"		1NO - 1NC			
	A = Momentary pushbutton red, surface, label "STOP"		1NO - 1NC			





Class 50 Standard Duty Pushbutton Stations

Standard duty station accessories

Selection and ordering data

Legend inscription insert for snap-on mounting

Inscription	Color	Order No.	Pack
			Unit
Close	Orange	50D53493005	1
Down	Orange	50D53493010	1
Fast	Black	50D53493013	1
Forward	Green	50D53493006	1
High	Black	50D53493015	1
Hoist	Green	50D53493011	1
Jog	Black	50D53493008	1
Low	Black	50D53493016	1
Lower	Orange	50D53493012	1
Off	Red	50D53493018	1
On	Green	50D53493017	1
Open	Green	50D53493004	1
Reverse	Orange	50D53493007	1
Slow	Black	50D53493014	1
Start	Green	50D53493001	1
Stop	Red	50D53493002	1
Stop (raised)	Red	50D53493003	1
Up	Green	50D53493009	1

Version	Suitable for	Color	Order No.	Pack
				Unit
 50ZAC1	Mushroom head	Red	50ZMH	1
 50ZAC2	Padlock attachment Used only for raised buttons		50ZAL	1
	Mechanical interlock kit		50ZAM	1
 50ZAC8	Contact blocks 1NO, 1NC 2NO, 2SPST	Single button Selector switch	50ZAC1 50ZAC8	1 1
 50ZAC3	1NO, 1NC 1NO, 1NO	Two button Two button	50ZAC2 50ZAC3	1 1
	Pilot light	120/240V Dual Voltage, no lens	50ZAC6	1
	Pilot light lens	Red Green	50ZPL01 50ZPL02	1 1
	Replacement lamps Slide base, lamp type 120PSB	Class 50 type 1, 1B 120V	50D21983001	1

Heavy duty station accessories

Version	Suitable for	Color	Order No.	Pack	
				Unit	
	Pushbutton caps	NEMA 4 control stations NEMA 4 control stations	Red Black	BHP15X BHP16X	1 1

Class 50 Standard Duty Pushbutton Stations

Standard duty - 5A 600V AC NEMA B600

1 Unit Station Surface Mounting—Type 1

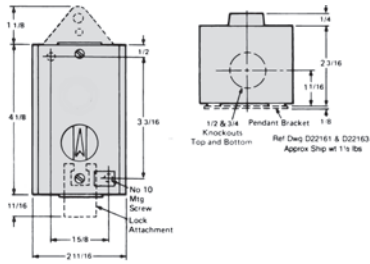

1 Unit Station Flush Mounting—Type 1B

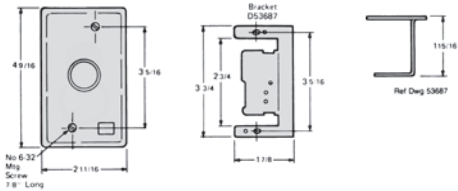

2 Pushbutton Stations Surface Mounting—Type 1

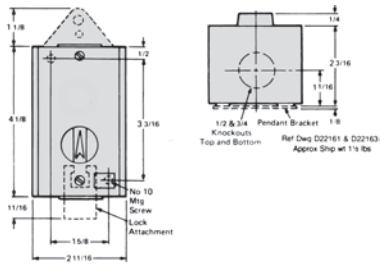

2 Pushbutton Stations Flush Mounting—Type 1B

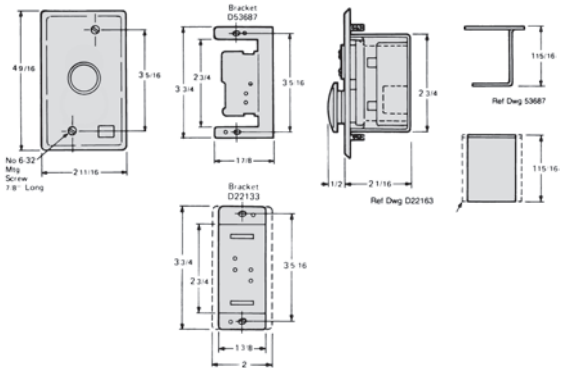

2 Unit Stations Surface Mounting—Type 1

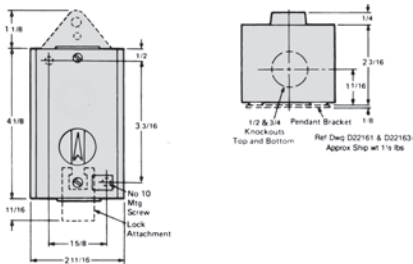

2 Unit Station Flush Mounting—Type 1B

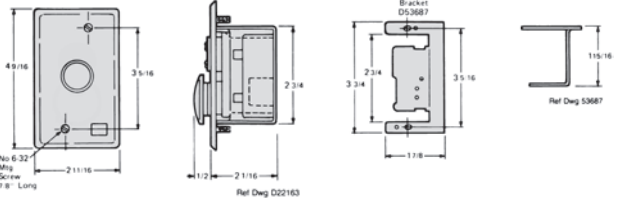

3 Unit Stations Surface Mounting

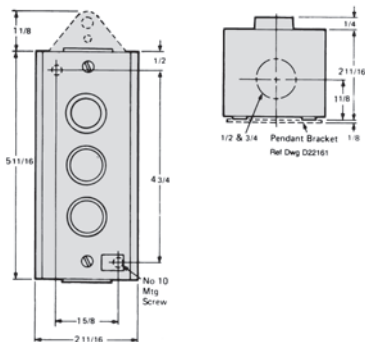

1 Unit Stations—Type 4

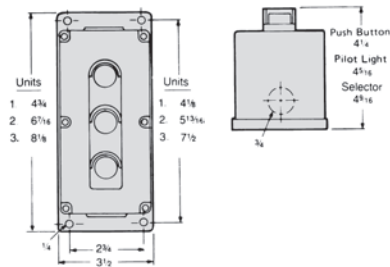

Class 51 Pilot Devices

Hazardous location

Features

- UL Listed and cUL Listed for Class I, Groups C & D and Class II, Groups E, F & G
- Short or Long Bushing Lengths
- Mount into 3/4-14 NPSM Threaded Hole
- Sealing Lock Nut
- Similar in Appearance to Class 52 Oil Tight Pilot Devices
- Double Break Bifurcated Contacts Rated AC NEMA A600, DC NEMA P600
- ⊕ Positively Driven Contacts
- Touchsafe Terminals
- UL Listed File # E39935
- CSA File No: 023889_0_000

Application

When properly installed in a Type 7 & 9 enclosure, these components meet the National Electrical Code's requirements for Class I, Division 1 & 2, Groups C and D hazardous gases, Class II, Division 1, Groups E, F and G hazardous dust, and Class III, hazardous fibers and flyings. Class 51 pilot devices may be used in a location where the presence of flammable gases, vapors or finely pulverized dusts in the atmosphere are sufficient to create a threat of explosion or fire. They may also be required where easily ignitable fibers or flyings are present. Short bushing units are used in most standard Type 7 & 9 enclosures. Long bushings are used when an additional front panel is required or in enclosures up to 2 1/8 inches thick. Class 51 devices also meet Type 4 applications.

Rugged

Hazardous location control units are durable one piece castings of a corrosion resistant copper free aluminum alloy with stainless steel springs and type 316 stainless steel shafts to provide a long dependable life. The "O" ring ensures the longest seal life available. Contact blocks have double break bifurcated contacts for increased reliability.

Pilot light bulbs are removable from the front for ease of maintenance. Many common parts between the Class 51 hazardous location pilot devices and the Class 52 oil tight pilot devices allow for increased serviceability with fewer parts.

Industrial Appearance

Hazardous location control units add luster to panels. They are uniform in appearance and match 52 Class oil tight pilot devices.

Typical Applications

Class I

Class II

Class III

Electrical Ratings

NEMA AC Ratings 50/60Hz

Nema A600 10 Continuous Amps

Volts	Make	Break
120	60	6
240	30	3
480	15	1.5
600	12	1.2
VA	7200	720

Ordering Information

- Accessories [see page 10/191-10/192.](#)
- Selector Operating Position and Contact Operation [page 10/189.](#)
- Legend Plates [see page 10/229.](#)
- Enclosures [see page 10/190.](#)
- Technical Specifications: [page 10/231.](#)

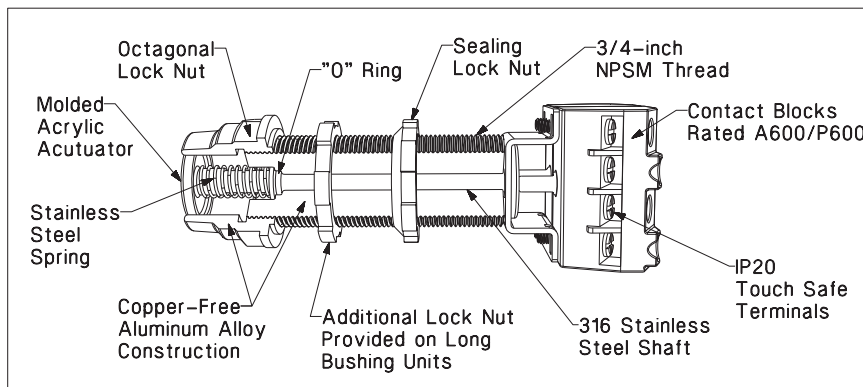



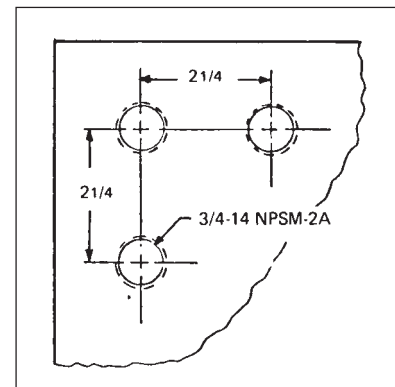

Panel Spacing



Class 51, Hazardous Location NEMA Type 7 & 9 Devices

Operators only



Selection and ordering data

	Version	Color of operator	Contacts	Short bushing Order No.	Long bushing Order No.	Pack Unit
Pushbutton with flat cap 	Pushbutton with flush cap	Black		51PA8A1	51PA8A1LB	1
		Red		51PA8A2	51PA8A2LB	1
		Green		51PA8A3	51PA8A3LB	1
Pushbutton with extended cap 	Pushbutton with extended cap	Black		51PA8B1	51PA8B1LB	1
		Red		51PA8B2	51PA8B2LB	1
		Green		51PA8B3	51PA8B3LB	1
Dual pushbutton 	Dual Pushbutton	Flush Black		51PD8A1B2	51PD8A1B2LB	1
		Raised Red				
	Pushbutton with mushroom cap 1 5/8"(41.3mm)	Black		51PA9D1	51PA9D1LB	1
		Red		51PA9D2	51PA9D2LB	1
		Green		51PA9D3	51PA9D3LB	1
	Pushbutton with mushroom cap 2 1/2"(63.5mm)	Black		51PA9E1	51PA9E1LB	1
		Red		51PA9E2	51PA9E2LB	1
		Green		51PA9E3	51PA9E3LB	1
		Less head		51PA9	51PA9LB	1
2 position push-pull 	2 Position Push Pull Maintained, Non Illuminated Small Plastic Mushroom Head, 1 5/8" (41.3 mm)	Black		51PA2D1	51PA2D1LB	1
		Red		51PA2D2	51PA2D2LB	1
		Green		51PA2D3	51PA2D3LB	1
	Large Plastic Mushroom Head, 2 1/4" (57.2 mm)	Black		51PA2E1	51PA2E1LB	1
		Red		51PA2E2	51PA2E2LB	1
		Green		51PA2E3	51PA2E3LB	1
		Less head		51PA2	51PA2LB	1
	2 Position Push Pull Maintained, Non Illuminated Small Mushroom Head, 1 5/8"(41.3mm)	Black	1NC + 1NO	51PA2D1A	51PA2D1LBA	1
		Red	1NC + 1NO	51PA2D2A	51PA2D2LBA	1
		Green	1NC + 1NO	51PA2D3A	51PA2D3LBA	1
	Large Mushroom Head, 2 1/2"(63.5mm)	Black	1NC + 1NO	51PA2E1A	51PA2E1LBA	1
		Red	1NC + 1NO	51PA2E2A	51PA2E2LBA	1
		Green	1NC + 1NO	51PA2E3A	51PA2E3LBA	1
3 position push-pull 	3 Position Push Pull Momentary, Non Illuminated Small Mushroom Head, 1 5/8"(41.3mm)	Black	1NC + 1NO	51PA3A1U	51PA3A1ULB	1
		Red	1NC + 1NO	51PA3A2U	51PA3A2ULB	1
		Green	1NC + 1NO	51PA3A3U	51PA3A3ULB	1

Class 51, Hazardous Location NEMA Type 7 & 9 Devices

Indicator light

Selection and ordering data

Version	Color of operator	Contacts	Short bushing Order No.	Long bushing Order No.	Pack Unit		
Indicator light- full voltage 	Indicator light with glass lens - Full voltage type AC/DC (with 6" pigtail leads) ^{1) 3)}						
	Operators with Incandescent Lamp 6-8V with 755 type	Red Green Amber Less lens		51PC5B2 51PC5B3 51PC5B9 51PC5BN	51PC5B2LB 51PC5B3LB 51PC5B9LB 51PC5BNLB	1	
	12V with 756 type	Red Green Amber Less lens		51PC5C2 51PC5C3 51PC5C9 51PC5CN	51PC5C2LB 51PC5C3LB 51PC5C9LB 51PC5CNLB	1	
	24V with 757 type	Red Green Amber Less lens		51PC5D2 51PC5D3 51PC5D9 51PC5DN	51PC5D2LB 51PC5D3LB 51PC5D9LB 51PC5DNLB	1	
	Operators with LED Lamp ²⁾ 6-8V with BA9 type LED	Red Green Amber		51PE5B2 51PE5B3 51PE5B9	51PE5B2LB 51PE5B3LB 51PE5B9LB	1	
	24V with BA9 type LED	Red Green Amber		51PE5D2 51PE5D3 51PE5D9	51PE5D2LB 51PE5D3LB 51PE5D9LB	1	
	Indicator light- transformer type 	Indicator light with glass lens - Transformer type AC/DC ^{1) 3)}					
		Operators with Incandescent Lamp 120V with 6V 755 type lamp	Red Green Amber Less lens		51PC5G2 51PC5G3 51PC5G9 51PC5GN	51PC5G2LB 51PC5G3LB 51PC5G9LB 51PC5GNLB	1
		240V with 6V 755 type lamp	Red Green Amber Less lens		51PC5H2 51PC5H3 51PC5H9 51PC5HN	51PC5H2LB 51PC5H3LB 51PC5H9LB 51PC5HNLB	1
		480V with 6V 755 type lamp	Red Green Amber Less lens		51PC5J2 51PC5J3 51PC5J9 51PC5JN	51PC5J2LB 51PC5J3LB 51PC5J9LB 51PC5JNLB	1
		600V with 6V 755 type lamp	Red Green Amber Less lens		51PC5K2 51PC5K3 51PC5K9 51PC5KN	51PC5K2LB 51PC5K3LB 51PC5K9LB 51PC5KNLB	1
		Operators with LED Lamp ²⁾ 120V with 6V BA9 type LED	Red Green Amber Less lens		51PE5G2 51PE5G3 51PE5G9 —	51PE5G2LB 51PE5G3LB 51PE5G9LB —	1
240V with 6V BA9 type LED		Red Green Amber Less lens		51PE5H2 51PE5H3 51PE5H9 —	51PE5H2LB 51PE5H3LB 51PE5H9LB —	1	
480V with 6V BA9 type LED		Red Green Amber Less lens		51PE5J2 51PE5J3 51PE5J9 —	51PE5J3LB 51PE5J3LB 51PE5J9LB —	1	
600V with 6V BA9 type LED		Red Green Amber Less lens		51PE5K2 51PE5K3 51PE5K9 —	51PE5K2LB 51PE5K3LB 51PE5K9LB —	1	

1) For other colors not listed, order operator less lens and separate lens from page 10/127.



2) LED color must match lens color.

3) All illuminated devices come with std. Touch-safe shield per UL stds.



Class 51, Hazardous Location NEMA Type 7 & 9 Devices

Push to test complete units

Selection and ordering data

Version	Color of operator	Contacts	Short bushing Order No.	Long bushing Order No.	Pack Unit	
Push to test full voltage 	Push to test/Illuminated pushbutton with glass lens - Full voltage type AC/DC ^{1) 3)}					
	Red	1NO + 1NC	51PC6B2A	51PC6B2ALB	1	
	Green	1NO + 1NC	51PC6B3A	51PC6B3ALB	1	
	Amber	1NO + 1NC	51PC6B9A	51PC6B9ALB	1	
	Less lens	1NO + 1NC	51PC6BNA	51PC6BNALB	1	
	24V with 757 type lamp	Red	1NO + 1NC	51PC6D2A	51PC6D2ALB	1
		Amber	1NO + 1NC	51PC6D3A	51PC6D3ALB	1
		Green	1NO + 1NC	51PC6D9A	51PC6D9ALB	1
		Less lens	1NO + 1NC	51PC6DNA	51PC6DNALB	1
	Operators with LED Lamp ²⁾ 6-8V with BA9 type LED	Red	1NO + 1NC	51PE6B2A	51PE6B2ALB	1
	Green	1NO + 1NC	51PE6B3A	51PE6B3ALB	1	
	Amber	1NO + 1NC	51PE6B9A	51PE6B9ALB	1	
24V with BA9 type LED	Red	1NO + 1NC	51PE6D2A	51PE6D2ALB	1	
	Green	1NO + 1NC	51PE6D3A	51PE6D3ALB	1	
	Amber	1NO + 1NC	51PE6D9A	51PE6D9ALB	1	
Push to test transformer type 	Push to test/Illuminated pushbutton with glass lens - Transformer type (50/60 Hz) ^{1) 3)}					
	Red	1NO + 1NC	51PC6G2A	51PC6G2ALB	1	
	Green	1NO + 1NC	51PC6G3A	51PC6G3ALB	1	
	Amber	1NO + 1NC	51PC6G9A	51PC6G9ALB	1	
	Less lens	1NO + 1NC	51PC6GNA	51PC6GNALB	1	
	240V with 6V 755 type lamp	Red	1NO + 1NC	51PC6H2A	51PC6H2ALB	1
		Green	1NO + 1NC	51PC6H3A	51PC6H3ALB	1
		Amber	1NO + 1NC	51PC6H9A	51PC6H9ALB	1
		Less lens	1NO + 1NC	51PC6HNA	51PC6HNALB	1
	480V with 6V 755 type lamp	Red	1NO + 1NC	51PC6J2A	51PC6J2ALB	1
		Green	1NO + 1NC	51PC6J3A	51PC6J3ALB	1
		Amber	1NO + 1NC	51PC6J9A	51PC6J9ALB	1
		Less lens	1NO + 1NC	51PC6JNA	51PC6JNALB	1
	600V with 6V 755 type lamp	Red	1NO + 1NC	51PC6K2A	51PC6K2ALB	1
		Green	1NO + 1NC	51PC6K3A	51PC6K3ALB	1
		Amber	1NO + 1NC	51PC6K9A	51PC6K9ALB	1
		Less lens	1NO + 1NC	51PC6KNA	51PC6KNALB	1
	Operators with LED Lamp ²⁾ 120V with 6V BA9 type LED	Red	1NO + 1NC	51PE6G2A	51PE6G2ALB	1
	Green	1NO + 1NC	51PE6G3A	51PE6G3ALB	1	
	Amber	1NO + 1NC	51PE6G9A	51PE6G9ALB	1	
240V with 6V BA9 type LED	Red	1NO + 1NC	51PE6H2A	51PE6H2ALB	1	
	Green	1NO + 1NC	51PE6H3A	51PE6H3ALB	1	
	Amber	1NO + 1NC	51PE6H9A	51PE6H9ALB	1	
480V with 6V BA9 type LED	Red	1NO + 1NC	51PE6J2A	51PE6J2ALB	1	
	Green	1NO + 1NC	51PE6J3A	51PE6J3ALB	1	
	Amber	1NO + 1NC	51PE6J9A	51PE6J9ALB	1	
600V with 6V BA9 type LED	Red	1NO + 1NC	51PE6K2A	51PE6K2ALB	1	
	Green	1NO + 1NC	51PE6K3A	51PE6K3ALB	1	
	Amber	1NO + 1NC	51PE6K9A	51PE6K9ALB	1	

Overload reset operators with reset legend plate

Version	Color	Legend Inscription	Order No.
 Single unit 7/8" diameter reset pad, 10" shaft can be cut to length.	Red	Reset	51AAS
 Multi unit For use with multi push operation requirements.	Red	Reset	51AAM

1) For other colors not listed, order operator less lens and separate lens from page 10/127.



2) LED color must match lens color.

3) All illuminated devices come with std. Touch-safe shield per UL stds.

Class 51, Hazardous Location NEMA Type 7 & 9 Devices

Selector switch operators

Selection and ordering data

Version	Lever type	Color of insert	Cam Code 1) 2)	Short bushing Order No.	Long bushing Order No.	Pack Unit	
	Short lever, non-Illuminated	White	A	51SA2AA	51SA2AALB	1	
	Long lever, non-Illuminated	White	A	51SB2AA	51SB2AALB		
	Spring return from right operation	Short lever, non-Illuminated	White	A	51SA2AC	51SA2ACLB	1
		Long lever, non-Illuminated	White	A	51SB2AC	51SB2ACLB	
Selector switches with 3 switching positions Maintained operation	Short lever, non-Illuminated	White	B	51SA2BA	51SA2BALB	1	
	Long lever, non-Illuminated	White	B	51SB2BA	51SB2BALB		
	Short lever, non-Illuminated	White	C	51SA2CA	51SA2CALB		
	Long lever, non-Illuminated	White	C	51SB2CA	51SB2CALB		
	Short lever, non-Illuminated	White	D	51SA2DA	51SA2DALB		
	Long lever, non-Illuminated	White	D	51SB2DA	51SB2DALB		
	Short lever, non-Illuminated	White	E	51SA2EA	51SA2EALB		
	Long lever, non-Illuminated	White	E	51SB2EA	51SB2EALB		
	Short lever, non-Illuminated	White	G	51SA2GA	51SA2GALB		
	Long lever, non-Illuminated	White	G	51SB2GA	51SB2GALB		
Spring return from right operation	Short lever, non-Illuminated	White	B	51SA2BC	51SA2BCLB	1	
	Long lever, non-Illuminated	White	B	51SB2BC	51SB2BCLB		
	Short lever, non-Illuminated	White	C	51SA2CC	51SA2CCLB		
	Long lever, non-Illuminated	White	C	51SB2CC	51SB2CCLB		
	Short lever, non-Illuminated	White	D	51SA2DC	51SA2DCLB		
	Long lever, non-Illuminated	White	D	51SB2DC	51SB2DCLB		
	Short lever, non-Illuminated	White	E	51SA2EC	51SA2ECLB		
	Long lever, non-Illuminated	White	E	51SB2EC	51SB2ECLB		
Spring return from left operation	Short lever, non-Illuminated	White	B	51SA2BB	51SA2BBLB	1	
	Long lever, non-Illuminated	White	B	51SB2BB	51SB2BBLB		
	Short lever, non-Illuminated	White	C	51SA2CB	51SA2CBLB		
	Long lever, non-Illuminated	White	C	51SB2CB	51SB2CBLB		
	Short lever, non-Illuminated	White	D	51SA2DB	51SA2DBLB		
	Long lever, non-Illuminated	White	D	51SB2DB	51SB2DBLB		
	Short lever, non-Illuminated	White	E	51SA2EB	51SA2EBLB		
	Long lever, non-Illuminated	White	E	51SB2EB	51SB2EBLB		
Spring return from left and right operation	Short lever, non-Illuminated	White	B	51SA2BD	51SA2BDLB	1	
	Long lever, non-Illuminated	White	B	51SB2BD	51SB2BDLB		
	Short lever, non-Illuminated	White	C	51SA2CD	51SA2CDLB		
	Long lever, non-Illuminated	White	C	51SB2CD	51SB2CDLB		
	Short lever, non-Illuminated	White	D	51SA2DD	51SA2DDLb		
	Long lever, non-Illuminated	White	D	51SB2DD	51SB2DDLb		
	Short lever, non-Illuminated	White	E	51SA2ED	51SA2EDLB		
	Long lever, non-Illuminated	White	E	51SB2ED	51SB2EDLB		
	Short lever, non-Illuminated	White	G	51SA2GD	51SA2GDLB		
	Long lever, non-Illuminated	White	G	51SB2GD	51SB2GDLB		

1)C CAM limited to 4 single or double pole blocks on spring return operators.

2)For contact operation, see CAM selection chart on [page 10/189](#).

Class 51, Hazardous Location NEMA Type 7 & 9 Devices

Selector switch operators

Selection and ordering data



Version	Key removal position	Lock number	CAM Code 1) 2)	Short bushing Order No.	Long bushing Order No.	Pack Unit
Key-operated selector switches with 2 switching positions	Both	550CH	A	51SA6AE	51SA6AELB	1
	Left	550CH	A	51SA6AF	51SA6AFLB	
	Right	550CH	A	51SA6AG	51SA6AGLB	
Maintained operation	Right	550CH	A	51SA6AG	51SA6AGLB	
Spring return from right operation	Left	550CH	A	51SA6AC	51SA6ACLB	1
Key-operated selector switches with 3 switching positions	All	550CH	B	51SA6BE	51SA6BELB	1
			C	51SA6CE	51SA6CELB	
			D	51SA6DE	51SA6DELB	
			E	51SA6EE	51SA6EELB	
			G	51SA6GE	51SA6GELB	
	Left	550CH	B	51SA6BF	51SA6BFLB	1
			C	51SA6CF	51SA6CFLB	
			D	51SA6DF	51SA6DFLB	
			E	51SA6EF	51SA6EFLB	
			G	51SA6GF	51SA6GFLB	
	Right	550CH	B	51SA6BG	51SA6BGLB	1
			C	51SA6CG	51SA6CGLB	
			D	51SA6DG	51SA6DGLB	
			E	51SA6EG	51SA6EGLB	
			G	51SA6GG	51SA6GGLB	
Center	550CH	B	51SA6BH	51SA6BHLB	1	
		C	51SA6CH	51SA6CHLB		
		D	51SA6DH	51SA6DHLB		
		E	51SA6EH	51SA6EHLB		
		G	51SA6GH	51SA6GHLB		
Left and Center	550CH	B	51SA6BK	51SA6BKLB	1	
		C	51SA6CK	51SA6CKLB		
		D	51SA6DK	51SA6DKLB		
		E	51SA6EK	51SA6EKLb		
		G	51SA6GK	51SA6GKLB		
Spring return from right operation	Center	550CH	B	51SA6BU	51SA6BULB	1
			C	51SA6CU	51SA6CULB	
			D	51SA6DU	51SA6DULB	
			E	51SA6EU	51SA6EULB	
			G	51SA6GU	51SA6GULB	
Spring return from left operation	Center	550CH	B	51SA6BT	51SA6BTLB	1
			C	51SA6CT	51SA6CTLB	
			D	51SA6DT	51SA6DTLB	
			E	51SA6ET	51SA6ETLB	
			G	51SA6GT	51SA6GTLB	
Spring return from left and right operation	Center	550CH	B	51SA6BV	51SA6BVLB	1
			C	51SA6CV	51SA6CVLB	
			D	51SA6DV	51SA6DVLB	
			E	51SA6EV	51SA6EVLB	
			G	51SA6GV	51SA6GVLB	

See page 10/213 for replacement keys, and up-to 15 additional uniquely keyed M - Series Lock Options available for use with the 51SA6 key-operated selector switches.

5

5

To order special locks for keyed selector switches, append corresponding 'X' suffix to part number

Ordering example:
51SA6AEX298

#549CH	X639		1
#548CH	X640		1
#547CH	X641		1
#501CH	X642		1
#506CH	X643		1

1)C CAM limited to 4 single or double pole blocks on spring return operators.

2)For contact operation, see CAM selection chart on page 10/189.

Class 51, Hazardous Location NEMA Type 7 & 9 Devices

Cam selection

Selection and ordering data

Design	Ordering Information
	<ul style="list-style-type: none"> Contact blocks are ordered separately, see page 10/192. Determine which table to use based upon the type of selector (non-illuminated & keyed on top, illuminated on bottom). Find the correct number of selector positions (2, 3 or 4 positions). Select the contact operation required for each selector position. X indicates the contacts are closed, while O indicates the contacts are open. (For the selector pushbutton, N=normal and D=depressed). Contact block must be assembled in position shown for each circuit application. Identify the CAM letter required for the chosen contact operation (only 1 CAM can be used per selector switch or selector pushbutton). Contact blocks must be assembled in the position shown for each circuit application. The mounting position is viewed from the front of the device. <p>Ordering CAMs D, E or G</p> <ul style="list-style-type: none"> CAM D, E or G may be ordered at the same price by changing the 6th character of the selector catalog number. Example: Selector with D cam 51SA2DA. <p>Size Requirements</p> <ul style="list-style-type: none"> C CAM on spring return selectors is limited to 4 contact blocks. Standard push buttons accept 4 contact blocks on each side, for a maximum of 8 contact blocks. Selector operators in enclosures are limited to depth of 1 contact block. (2 blocks wide).

Non-illuminated and keyed selector switches (viewed from front)

2 Selector Positions			Contact Blocks	CAM	Mounting		
Left	Right	Left			Right		
X	O	52BAJ (NC)	A	L	or	R	
O	X	52BAK (NO)	A	L	or	R	
3 Selector Positions			Contact Blocks	CAM	Mounting		
Left	Center	Right			Left	Right	
X	O	O	52BAK (NO)	B		R	
O	O	X	52BAK (NO)	B	L		
X	X	O	52BAJ (NC)	B	L		
O	X	X	52BAJ (NC)	B	R		
O	O	X	52BAK (NO)	C	L	or	R
X	O	O	52BAJ (NC)	C	L	or	R
O	O	X	52BAK (NO)	D	L	or	R
O	X	O	52BAJ (NC)	D	L	or	R
X	O	O	52BAK (NO)	E	L	or	R
O	X	O	52BAJ (NC)	E	L	or	R
X	O	O	52BAJ (NC)	G	L		
O	X	O	52BAJ (NC)	G			R
O	O	X	52BAK (NO)	G	L	or	R

Illuminated selector switches





2 Selector Positions		Contact Blocks	CAM	Mounting	
Left	Right			Left	Right
X	O	52BAJ (NC)	A	L	
O	X	52BAK (NO)	A	L	

1) Wired in parallel.

Class 51, Hazardous Location NEMA Type 7 & 9 Devices

Control stations

Selection and ordering data

	Operator Identification ¹⁾	Degree of operator	Contacts/voltage	Number of command points	Order No.	Pack
						Unit
	A = Momentary flush pushbutton black, label "START"	NEMA 7/9	1NO - 1NC	1	51C101H	1
	A = Momentary raised pushbutton red, label "STOP"	NEMA 7/9	1NO - 1NC	1	51C103H	1
	A = Momentary 1 5/8" mushroom head red label "STOP"	NEMA 7/9	1NO - 1NC	1	51C104H	1
	A = Momentary dual pushbutton red label "START, STOP"	NEMA 7/9	1NO - 1NC	1	51C105H	1
	A = 2 position selector switch label "Off-On"	NEMA 7/9	1NO - 1NC	1	51C159H	1
	A = 3 position selector switch label "HAND-OFF-AUTO"	NEMA 7/9	1NO - 1NC	1	51C156H	1
	A = Indicator light, green, 120 V A = Indicator light, red, 120 V	NEMA 7/9 NEMA 7/9			1 1	51C131H 51C135H
	B = Momentary flush pushbutton black, label "START" A = Momentary raised pushbutton red, label "STOP"	NEMA 7/9	1NO - 1NC 1NO - 1NC	2	51C201H	1
	B = Momentary flush pushbutton black, label "FORWARD" A = Momentary flush pushbutton red, label "REV"	NEMA 7/9	1NO - 1NC 1NO - 1NC	2	51C204H	1
	B = Momentary flush pushbutton black, label "START" A = Momentary 1 5/8" mushroom head pushbutton red, label "STOP"	NEMA 7/9	1NO - 1NC 1NO - 1NC	2	51C202H	1
	B = Indicator light, red, 120 V A = Indicator light, green, 120 V	NEMA 7/9	1NO - 1NC 1NO - 1NC	2	51C230H	1
	C = Momentary flush pushbutton black, label "FORWARD" B = Momentary flush pushbutton black, label "REVERSE" A = Momentary raised pushbutton red, label "STOP"	NEMA 7/9	1NO - 1NC 1NO - 1NC 1NO - 1NC	3	51C301H	1
	C = Momentary flush pushbutton black, label "OPEN" B = Momentary flush pushbutton black, label "CLOSE" A = Momentary raised pushbutton red, label "STOP"	NEMA 7/9	1NO - 1NC 1NO - 1NC 1NO - 1NC	3	51C303H	1
	C = Indicator light, green, 120 V B = Momentary flush pushbutton black, label "START" A = Momentary raised pushbutton red, label "STOP"	NEMA 7/9	1NO - 1NC 1NO - 1NC	3	51C307H	1
Enclosures only²⁾						
	For field assembly of Type 7 & 9 UL listed and cUL listed control stations. Devices may be installed for either horizontal or vertical mounting using a standard legend. Limited to depth of 1 contact block.			1	51EA1H	1
				2	51EA2H	1
				3	51EA3H	1













1) All enclosures come standard with one conduit entry on top. To get two conduit entries, append X-311 to the end of the order number.

2) For legend plates see page 10/229.

Class 51, Hazardous Location NEMA Type 7 & 9 Devices

Accessories and spare parts

Selection and ordering data

Version	Suitable for	Conduit size (in.)	Color	Order No.	Pack Unit
	For small 1 5/8" (41.3mm) type, non-illuminated mushroom push-buttons		Black	52RB3D1	1
			Red	52RB3D2	
			Green	52RB3D3	
			Yellow	52RB3D4	
			Blue	52RB3D5	
			Gray	52RB3D6	
			Orange	52RB3D8	
			1 kit of each	52RB3DN	
				For large 2 1/2" (63.5mm) type, non-illuminated mushroom push-buttons	
Red	52RB3E2				
Green	52RB3E3				
Yellow	52RB3E4				
Blue	52RB3E5				
Gray	52RB3E6				
Orange	52RB3E8				
1 kit of each	52RB3EN				
	Replacement lens for pilot lights				Red
			Green	51RC4G3	
			Blue	51RC4G5	
			Amber	51RC4G9	
			Clear	51RC4GA	
	Replacement lens for push to test/illuminated pushbuttons		Red	51RC5G2	1
			Green	51RC5G3	
			Amber	51RC5G9	
	Guards		Chrome	51AAGM	1
	Prevents accidental operation	Non-illuminated Pushbuttons & Push Pull Operators with Mushroom Head Caps 1 5/8" to 1 3/4" in diameter.			
	Lever inserts		Red	52RA2A2	1
			Green	52RA2A3	
			Blue	52RA2A4	
			Amber	52RA2A5	
			Gray	52RA2A6	
			Orange	52RA2A8	
			White	52RA2AB	
	Long lever		Red	52RA2B2	1
			Green	52RA2B3	
			Blue	52RA2B4	
			Amber	52RA2B5	
			Gray	52RA2B6	
			Orange	52RA2B8	
			White	52RA2BB	
	Padlock attachment	Only for raised pushbutton operators		51AAL	1
	Breather/drain (Stainless Steel)	Installs in bottom as a drain or in the top as a breather. Suitable for Class 1 groups C & D and for Class 2 groups F & G applications only. Fits 1/2" NPT.		51AADB	1
	Lock nut wrench	All devices		52MAWB	1
	Spare keys	550CH (1 key)		52KEY-550CH	1

Class 51, Hazardous Location NEMA Type 7 & 9 Devices

Accessories and spare parts

Selection and ordering data



Version	Suitable for	Conduit size (in.)	Color	Order No.	Pack Unit			
Reducer bushings	Cast aluminum, UL recognized and CSA certified. Used to reduce existing tapered NPT conduit opening when required.	3/4 - 1/2		51AARBA	1			
		1 - 1/2		51AARCA				
		1 1/2 - 3/4		51AARDB				
		1 1/2 - 1		51AARDC				
		2 1/2 - 3/4		51AARFB				
		2 1/2 - 1		51AARFC				
		2 1/2 - 1 1/2		51AARFD				
		2 1/2 - 2		51AARFE				
		3 - 1		51AARGC				
		3 - 1 1/2		51AARGD				
		3 - 2		51AARGE				
		3 - 2 1/2		51AARGF				
		Lamps with screw connection, miniature bayonet incandescent lamps						
		Flashing, type 267 lamp (replaces 755 lamp)	51, 52	6V	52AABNF	1		
		6V Full voltage, transformer type 755 lamp	51, 52	6V	52AABN	1		
		12V full voltage, type 756	51, 52	12V	52AACN	1		
		24V full voltage, 120/240V resistor push-to-test type 757	51, 52	24V	52AADN	1		
		Neon (uses resistors) type B2A (NE-51H)	51, 52	120V	52AAPN	1		
		120V, full voltage type 3S6/5	51, 52	120V	52AAENC	1		
		LEDs, Single element		51, 52	6V	Red	52AEB2	1
				51, 52	6V	Green	52AEB3	
				51, 52	6V	Yellow	52AEB4	
				51, 52	6V	White	52AEBB	
				51, 52	6V	Blue	52AEB5	
				51, 52	24V	Red	52AED2	
				51, 52	24V	Green	52AED3	
				51, 52	24V	Yellow	52AED4	
				51, 52	24V	White	52AEDB	
51, 52	24V			Blue	52AED5			
51, 52	120V	Red	52AEE2					
51, 52	120V	Green	52AEE3					
51, 52	120V	Yellow	52AEE4					
51, 52	120V	White	52AEEB					
51, 52	120V	Blue	52AEE5					



Class 51, Hazardous Location NEMA Type 7 & 9 Devices

Accessories and spare parts

Selection and ordering data

	Version	Suitable for	Conduit size (in.)	Color	Order No.	Pack Unit
	1 NO				52BAK	1
52BAJ	1 NC				52BAJ ^②	
	1 NO - 1 NC				52BJK ^②	
52BAK	1 NO early make	closes before 52BAK			52BAH	
	1 NC late break	opens after 52BAJ			52BAE	
52BAR	1 NO - 1 NC	Reed switch			52BAR ^①	
		UL listed for class 1 division 2				
		.25A Max, 200V AC, 10 Watt max				
		.5A Max, 200V DC, 10 Watt max				
	1 NC extra late break				52BAU	

① Hermetically sealed.

② ↻ Positive opening according to IEC 60947-5-1, Appendix K.

30 mm Heavy Duty, Watertight/Oiltight, Class 52

Pushbutton complete units

Features

- Octagonal Mounting Nuts
- Meets Type 1, 3, 3R, 4, 4X, 12, 13 and Automotive Standards
- Heavy Duty Rated NEMA A600/P600 Contacts
- ☞ Positively Driven Contacts
- Positive Indexing Selectors
- Bifurcated Movable Contacts
- Attractive Chrome Plating
- Boots Not Required for Type 4
- UL Listed File # E22655
- CSA Certified File # LR6535
- Touchsafe Terminals

Application

Oil tight pilot controls and accessories are designed to provide long, trouble free service in the most demanding industrial applications. These controls are oil and dust tight and meet Type 3, 4, 4X, 12 and 13 specifications.

Rugged

Industrial control operators are durable one piece castings. Heavy duty plastic buttons resist oils and corrosion. Silver contacts carry heavy duty ratings.

Flexible

Accessories modify standard push buttons, selector switches and pilot lights. Building block construction of contact blocks makes possible many circuitry combinations.

Industrial Appearance

Pilot controls add luster to panels. Chrome plating covers exposed metal parts.

Push Button Operators

The Operator Base consists of a durable, one piece casting equipped with a heavy duty actuator with a stainless steel spring, a neoprene actuator sealing ring to prevent oil and dust from penetrating to the contact blocks, a neoprene gasket to seal operator mounting hole and a chrome plated lock nut.

Mushroom Head Push Button Operators

The Mushroom Head base construction is identical to the push button base. The actuator is molded of high impact material for either a 1 5/8 inch or 2 1/2 inch diameter molded head.

E-STOP Mushroom Head Operators according to EN 60947-5-5 Cat. No. 52BP, 52BR, 52PP, and 52PR, 2 Position, Twist-To-Release & 2 Position, Push Pull Maintained operators provided with red operating heads and 52BJK contact blocks meet the requirements of EN 60947-5-5 for Electrical Emergency Stop Device With Mechanical Latching Function (e-stop).

Contact Blocks

Contact Blocks have double break bifurcated silver contacts, with gold flashing as standard, which improves contact reliability. Contact blocks are heavy duty rated NEMA A600 and suitable for applications down to 5V/1MA solid state outputs. 52BJK offers ☞ Positive Opening Contacts according to IEC 60947-5-1, Appendix K. Molded bodies and pushers resist arcing and tracking. All units have stainless steel springs that resist corrosion and provide strong contact pressure. Captive mounting screws speed panel assembly.

Push Pull Operators

Push Pull Operators combine two or three functions in one unit. The maintained operator has two positions, typically pull to start, push to stop. The momentary operator with three positions provides spring return from both pull and push positions. In addition, a three position push maintained, pull momentary operator is available. The actuator come is 1 3/4 inch or 2 1/2 inch diameter and is available in an illuminated version.

2 Button Maintained Operator

Maintained Push Buttons consist of two push buttons and a latching assembly. When actuated the button remains depressed and is freed only by the release operator to which it is linked. The button assembly adjusts for mounting from a 1 13/16 inch to a 2 5/8 inch center.

Transformer Type Pilot Lights

Transformer Type Pilot Lights are available with a 120, 240, 480 or 600 Volt primary (50/60 Hertz) and a separate secondary winding which supplies reduced voltage to a miniature bayonet base 6 Volt lamp. These units are suitable for applications where vibration is present and long bulb life is desirable.

Full Voltage Type Pilot Lights

Full Voltage Pilot Lights are available for 6, 12, 24 and 120 Volt AC and DC applications.

Electrical Ratings

NEMA AC Ratings 50/60Hz

NEMA A600 10 Continuous Amps

Volts	Make	Break
120	60	6
240	30	3
480	15	1.5
600	12	1.2
VA	7200	720

Ordering Information

- Accessories: [pages 10/218 – 10/221](#)
- Selector Position and Contact Operation: [page 10/216 – 10/217](#).
- Legend Plates: [page 10/229](#).
- Enclosures: [page 10/230](#).
- Technical Specifications: [page 10/231](#).

Resistor Type Pilot Lights

Resistor Type Pilot Lights are available for 240 Volt AC and DC applications. The 240 Volt pilot light is supplied with a 120 Volt lamp and a voltage dropping resistor.

LED Type Pilot Lights

LED's (light emitting diodes) can be used in pilot lights instead of incandescent bulbs because of their long life (up to 10 years), resistance to vibration and ambient sensitivity. Clusted LED options are available for standard pilot lights only. Cluster LED options are not available on Push to test Pilot Lights, Illuminated Pushbuttons, Push-pull, or Twist-to-Release Operators.

Integrated LED Module Type Pilot Lights

The integrated LED module is available for 24, 120, and 240 V. LED modules are vibration resistant and have a long life (up to 10 years). The integrated LED module is available for 24, 120, and 240 V. LED modules are vibration resistant and have a long life (up to 10 yrs.).

Selector Operators

Selector Operators have positive action indexing. Operators are available with either a short or long lever. The molded black lever is designed to accept a color insert. A white insert is provided as standard. Each operator is equipped with a cam to actuate plungers of contact blocks assembled behind the operator. Two, three and four position operators are available with seven different cams.

Lever color inserts are available in 8 colors.



Indicator Light

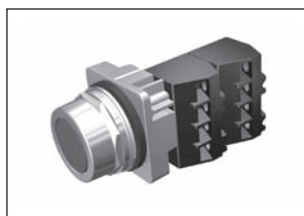

Push Button



Selector Switch



Selector Push Button

30mm Water, Oil Tight & Corrosion Resistant – Class 52

Push Button

Selection Guide

Momentary Push Button - Non-Illuminated

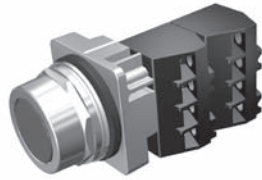

Flush Head



Extended Head

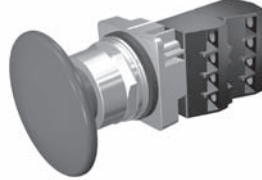

Large Mushroom Head 2 1/2"



Small Mushroom Head 1 3/4"

Part Number	52	a	M b	c	d	e¹
--------------------	-----------	----------	----------------------	----------	----------	----------------------

a	Code	Finish
	P	Chrome - Command 52
	B	Epoxy Coated - Black Max

b	Code	Type
	M	Momentary Push Button

c	Code	Style / Head Type
		Flush / Extended Cap²
	8A	Flush
	8B	Extended
		Mushroom Head Metal
	9A	Small Mushroom Head 1 3/4" (44.5mm)
		Mushroom Head Plastic
	9W	Small Mushroom Head 1 3/4" (44.5mm)
	9V	Large Mushroom Head 2 1/2" (63.5mm)

d	Code	Plastic	Metal
	1	Black	—
	2	Red	Red
	3	Green	Green
	4	Yellow	—
	5	Blue	—
	6	Gray	—
	7	All Color Caps	—
	8	Orange	—
C	—	Chrome	

e¹	Code	Contact Blocks
	A	1 NO + 1 NC
	B	2 NO + 2 NC
	C	3 NO + 3 NC
	D	4 NO + 4 NC
	E	1 NC (LB)
	F	2 NO
	G	2 NC
	H	1NO (EM)
	J	1 NC
	K	1 NO

¹ For operator without contact blocks leave position e blank.
² Products available fall 2014. For current product offer please refer to the 2010 Industrial Control Catalog.

Selection Tables

Momentary Push Button - Non-Illuminated

Head Style	Contacts	Color	Finish	
			Chrome	Black Max
Flush	—	Less cap	52PM8	52BM8
		Black	52PM8A1	52BM8A1
		Red	52PM8A2	52BM8A2
		Green	52PM8A3	52BM8A3
		Yellow	52PM8A4	52BM8A4
	1 NO - 1 NC	Black	52PM8A1A	52BM8A1A
		Red	52PM8A2A	52BM8A2A
		Green	52PM8A3A	52BM8A3A
	1 NO	Black	52PM8A1K	52BM8A1K
		Red	52PM8A2K	52BM8A2K
		Green	52PM8A3K	52BM8A3K
	1 NC	Red	52PM8A2J	52BM8A2J
Extended	—	Black	52PM8B1	52BM8B1
		Red	52PM8B2	52BM8B2
		Green	52PM8B3	52BM8B3
	1 NO	Black	52PM8B1K	52BM8B1K
		Red	52PM8B2K	52BM8B2K
	1 NC	Red	52PM8B2J	52BM8B2J
Mushroom Head Plastic Ø 1 3/4"	—	Less cap	52PM9	52BM9
		Red	52PM9W2	52BM9W2
	1 NO	Green	52PM9W3K	52BM9W3K
	1 NO - 1 NC	Black	52PM9W1A	52BM9W1A
		Red	52PM9W2A	52BM9W2A
	1 NO - 1 NC	Green	52PM9W3A	52BM9W3A
Mushroom Head Plastic Ø 2 1/2"	—	Red	52PM9V2	52BM9V2
		Black	52PM9V1A	52BM9V1A
	1 NO - 1 NC	Red	52PM9V2A	52BM9V2A
		Green	52PM9V3A	52BM9V3A

Readily available items are in **bold**.
This is a small representation of stocked items.

Selection Guide

2 & 3 Position Push-Pull Mushroom Head Devices - Non-Illuminated

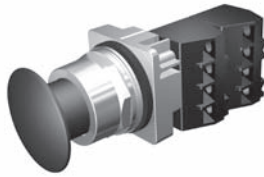

Mushroom Head Metal Ø 1 3/4"



Mushroom Head Plastic Ø 2 1/2"

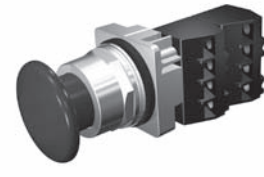

Mushroom Head Plastic Ø 1 3/4"

Part Number	52	<u> </u>	P	<u> </u>	<u> </u>	<u> </u>	<u> </u>
		a	b	c	d	e	f³

a	Code	Finish
	P	Chrome-Command 52
	B	Epoxy Coated-Black Max

b	Code	Type
	P	Push Pull

c	Code	Function
	2	2 positions - maintained ¹
	3	3 positions - momentary in - momentary out
	7	3 positions - maintained in - momentary out

d	Code	Style
	A	Small metal 1-3/4" (44.5 mm)
	W	Small plastic 1-3/4" (44.5 mm)
	V	Large plastic 2-1/2" (63.5 mm)

e	Code	Color	
		Plastic	Metal
	1	Black	—
	2	Red ¹	Red ¹
	3	Green	Green
	4	Yellow	—
	5	Blue	—
	6	Gray	—
	8	Orange	—
	C	—	Chrome
		No Operating Head	
	Z	No head	

f³	Code	Contact Blocks
		2 Position
	A	1 NO + 1 NC ¹
	B	2 NO + 2 NC ¹
	C	3 NO + 3 NC ¹
	D	4 NO + 4 NC ¹
	E	1 NC (LB)
	F	2 NO
	G	2 NC ¹
	H	1 NO (EM)
	J	1 NC ¹
	K	1 NO
	Q	1 NO - 1 NC (ELB)
		3 Position
	U	1 NO - 1 NC extra late break ²

¹ EMERGENCY-STOP control devices according to IEC 60947-5-5 when provided with red operating head and positively driven NC contact blocks. Positive opening contacts according to IEC 60947-5-1, Appendix K.

² Blocks cannot be interchanged (stop-start circuit - pull to start, push to stop).

³ For operator without contact blocks leave position f blank.

Selection Tables

2 & 3 Position Push-Pull Mushroom Head Devices - Non-Illuminated

		2 pos - maintained					
		Metal Ø 1 3/4"		Plastic Ø 1 3/4"		Plastic Ø 2 1/2"	
Contacts	Color	Chrome	Black Max	Chrome	Black Max	Chrome	Black Max
—	Black	—	—	52PP2W1	52BP2W1	52PP2V1	2BP2V1
	Red	52PP2A2	52BP2A2	52PP2W2	52BP2W2	52PP2V2	52BP2V2
	Green	52PP2A3	52BP2A3	52PP2W3	52BP2W3	52PP2V3	52BP2V3
	Yellow	—	—	52PP2W4	52BP2W4	52PP2V4	52BP2V4
1 NO - 1 NC	Red	52PP2A2A¹	52BP2A2A¹	52PP2W2A¹	52BP2W2A¹	52PP2V2A¹	52BP2V2A ¹
	Green	52PP2A3A	52BP2A3A	52PP2W3A	52BP2W3A	52PP2V3A	—
	Yellow	—	—	52PP2W4A	52BP2W4A	52BP2V4A	52BP2V4A
	Chrome	52PP2ACA	52BP2ACA	—	—	—	—

		3 pos - momentary in - momentary out					
		Metal Ø 1 3/4"		Plastic Ø 1 3/4"		Plastic Ø 2 1/2"	
Contacts	Color	Chrome	Black Max	Chrome	Black Max	Chrome	Black Max
—	Black	—	—	52PP3W1	52BP3W1	52PP3V1	52BP3V1
	Red	52PP3A2	52BP3A2	52PP3W2	52BP3W2	52PP3V2	52BP3V2
	Green	52PP3A3	52BP3A3	52PP3W3	52BP3W3	52PP3V3	2BP3V3
	Chrome	52PP3AC	52BP3AC	—	—	—	—
1 NO - 1 NCELB	Red	52PP3A2U	52BP3A2U	52PP3W2U	52BP3W2U	52PP3V2U	52BP3V2U
	Green	52PP3A3U	52BP3A3U	52PP3W3U	52BP3W3U	52PP3V3U	52BP3V3U

		3 pos - maintained in - momentary out					
		Metal Ø 1 3/4"		Plastic Ø 1 3/4"		Plastic Ø 2 1/2"	
Contacts	Color	Chrome	Black Max	Chrome	Black Max	Chrome	Black Max
—	Black	—	—	52PP7W1	52BP7W1	52PP7V1	52BP7V1
	Red	52PP7A2	52BP7A2	52PP7W2	52BP7W2	52PP7V2	52BP7V2
	Green	52PP7A3	52BP7A3	52PP7W3	52BP7W3	52PP7V3	52BP7V3
	Chrome	52PP7AC	52BP7AC	—	—	—	—
1 NO - 1 NCELB	Red	52PP7A2U1	52BP7A2U	52PP7W2U	52BP7W2U	52PP7V2U	52BP7V2U
	Green	52PP7A3U	52BP7A3U	52PP7W3U	52BP7W3U	52PP7V3U	52BP7V3U

Readily available items are in **bold**.
This is a small representation of stocked items.

¹ EMERGENCY-STOP control devices according to IEC 60947-5-5

30mm Water, Oil Tight & Corrosion Resistant – Class 52

Illuminated Push Pull & Push Button

Selection Guide

2 & 3 Position Push-Pull Mushroom Head Devices - Illuminated

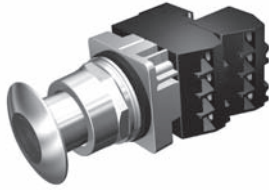

Mushroom Head Metal Ø 1 3/4"



Mushroom Head Plastic Ø 2 1/2"

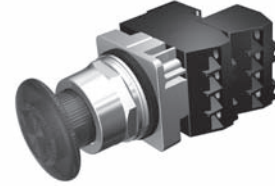

Mushroom Head Plastic Ø 1 3/4"

Part Number	52	a	P	c	d	e	f	g
-------------	-----------	----------	----------	----------	----------	----------	----------	----------

a	Code	Finish
	P	Chrome-Command 52
	B	Epoxy Coated-Black Max

b	Code	Type
	P	Push Pull Operator

c	Code	Function
	2	2 positions - maintained ¹
	3	3 positions - momentary in - momentary out ²
	7	3 positions - maintained in - momentary out ²

d	Code	Operation	
		Full Voltage ³ (AC/DC)	
		Incandescent	LED ⁴
	B	6-8V	6V
	C	12-13V	—
	D	24-28V	24-28V
	E	120V	120V
	F	—	240V
		Transformer ³	
	G	120V AC	
	H	240V AC	
	J	480V AC	
	K	600V AC	

e	Code	Style / Color
		Mushroom Head Metal Ø 1 3/4" (44.5mm)
	2	Red ¹
	3	Green
	5	Blue
	9	Amber
	A	Clear
	B	White
		Mushroom Head Plastic Ø 1 3/4" (44.5 mm)
	R	Red ¹
	S	Green
	T	Amber
		Mushroom Head Plastic Ø 2 1/2" (63.5mm)
	D	Red ¹
	E	Green
	F	Amber
		No Head (full voltage & transformer only)
	Z	No head

f	Code	Contact Blocks
		2 Position
	A	1 NO + 1 NC ¹
	B	2 NO - 2 NC ¹
	F	2 NO
	G	2 NC ¹
	J	1 NC ¹
	K	1 NO
	Q	1 NO - 1 NC (ELB)
		3 Position
	U	1 NO - 1 NC extra late break ²

g	Code	Bulb Type
	Blank	Incandescent
	B	LED
	Y	Super-Bright LED ⁵

1 EMERGENCY-STOP control devices according to IEC 60947-5-5 when provided with red operating head and positively driven NC contact blocks.

Positive opening contacts according to IEC 60947-5-1, Appendix K,

2 Blocks cannot be interchanged (stop-start circuit - pull to start, push to stop).

3 Default bulb type is incandescent. For LED options, append field g. LED option not available on units sold "no head".

4 LED voltages apply to table g option code B and Y.

6V and 120V are currently AC only. Replaced by AC/DC rated versions end of 2014.

5 Not available in 240V.

30mm Water, Oil Tight & Corrosion Resistant – Class 52

Illuminated Push Pull

Selection Tables

Type	Lamp Type	Voltage	Color	Contacts
Full Voltage (AC/DC)	LED	24V	Red	1 NO - 1 NC
			Green	1 NO - 1 NC
	Incandescent	24V	Red	1 NO - 1 NC
			Green	1 NO - 1 NC
		120V	Red	1 NO - 1 NC
			—	—
Transformer (AC)	LED	120V	Red	1 NO - 1 NC
			Green	1 NO - 1 NC
	Incandescent	120V	Red	1 NO - 1 NC
			Green	1 NO - 1 NC

Operator Type			
2 pos - maintained			
Metal Ø 1 3/4"		Plastic Ø 1 3/4"	
Chrome	Black Max	Chrome	Black Max
52PP2D2AB¹	52BP2D2AB¹	52PP2DRAB¹	52BP2DRAB¹
52PP2D3AB	52BP2D3AB	52PP2DSAB	52BP2DSAB
52PP2D2A¹	52BP2D2A¹	52PP2DRA¹	52BP2DRA¹
52PP2D3A	52BP2D3A	52PP2DSA	52BP2DSA
52PP2E2A ¹	52BP2E2A ¹	52PP2ERA ¹	52BP2ERA ¹
52PP2E2	52BP2E2	52PP2ER	52BP2ER
52PP2G2AB¹	52BP2G2AB¹	52PP2GRAB¹	52BP2GRAB¹
52PP2G3AB	52BP2G3AB	52PP2GSAB	52BP2GSAB
52PP2G2A¹	52BP2G2A¹	52PP2GRA¹	52BP2GRA¹
52PP2G3A	52BP2G3A	52PP2GSA	52BP2GSA

Type	Lamp Type	Voltage	Color	Contacts
Full Voltage (AC/DC)	LED	24V	Green	1 NO - 1 NCELB
			Green	1 NO - 1 NCELB
	Incandescent	24V	Red	1 NO - 1 NCELB
			Red	—
		120V	Red	—
			—	—
Transformer (AC)	LED	120V	Red	1 NO - 1 NCELB
			Green	1 NO - 1 NCELB
	Incandescent	120V	Red	1 NO - 1 NCELB
			Green	1 NO - 1 NCELB

Operator Type			
3 pos - momentary in - momentary out			
Metal Ø 1 3/4"		Plastic Ø 1 3/4"	
Chrome	Black Max	Chrome	Black Max
52PP3D3UB	52BP3D3UB	52PP3DRUB	52BP3DRUB
52PP3D3U	52BP3D3U	52PP3DSU	52BP3DSU
52PP3D2U	52BP3D2U	52PP3DRU	52BP3DRU
52PP3E2	52BP3E2	52PP3ER	52BP3ER
52PP3G2UB	52BP3G2UB	52PP3GRUB	52BP3GRUB
52PP3G3UB	52BP3G3UB	52PP3GSUB	52BP3GSUB
52PP3G2U	52BP3G2U	52PP3GRU	52BP3GRU
52PP3G3U	52BP3G3U	52PP3GRU	52BP3GRU

Type	Lamp Type	Voltage	Color	Contacts
Full Voltage (AC/DC)	LED	24V	Green	1 NO - 1 NCELB
			Green	1 NO - 1 NCELB
	Incandescent	24V	Red	1 NO - 1 NCELB
			Red	—
		120V	Red	—
			—	—
Transformer (AC)	LED	120V	Red	1 NO - 1 NCELB
			Green	1 NO - 1 NCELB
	Incandescent	120V	Red	1 NO - 1 NCELB
			Green	1 NO - 1 NCELB

Operator Type			
3 pos - maintained in - momentary out			
Metal Ø 1 3/4"		Plastic Ø 1 3/4"	
Chrome	Black Max	Chrome	Black Max
52PP7D3UB	52BP7D3UB	52PP7DSUB	52BP7DSUB
52PP7D3U	52BP7D3U	52PP7DSU	52BP7DSU
52PP7D2U	52BP7D2U	52PP7DRU	52BP7DRU
52PP7E2	52BP7E2	52PP7ER	52BP7ER
52PP7G2UB	52BP7G2UB	52PP7GRUB	52BP7GRUB
52PP7G3UB	52BP7G3UB	52PP7GSUB	52BP7GSUB
52PP7G2U	52BP7G2U	52PP7GRU	52BP7GRU
52PP7G3U	52BP7G3U	52PP7GRU	52BP7GRU

Readily available items are in **bold**.
This is a small representation of stocked items.

¹ EMERGENCY-STOP control devices according to IEC 60947-5-5

30mm Water, Oil Tight & Corrosion Resistant – Class 52

Non-Illuminated Twist-to-Release

Selection Guide

2 Position Twist-to-Release Devices Mushroom Head - Non-Illuminated

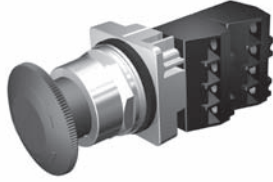

Plastic 1 3/4" Mushroom Head - Chrome



Plastic 1 3/4" Mushroom Head - Black Max

Part Number	52	<u> </u> a	<u> </u> R b	<u> </u> 8 c	<u> </u> W d	<u> </u> e	<u> </u> f²
--------------------	-----------	-------------------------	-------------------------------------	-------------------------------------	-------------------------------------	-------------------------	-------------------------------------

Finish	Function	Style	Color	Contacts	Part Number
Chrome	2 Position Twist-to-Release	Plastic 1 3/4" Mushroom Head	Red	1 NO - 1 NC	52PR8W2A
Black Max	2 Position Twist-to-Release	Plastic 1 3/4" Mushroom Head	Red	1 NO - 1 NC	52BR8W2A
Chrome	2 Position Twist-to-Release	Plastic 1 3/4" Mushroom Head	Red	None	52PR8W2

Readily available items are in **bold**.
This is a small representation of stocked items.

a	Code	Finish
	P	Chrome-Command 52
	B	Epoxy Coated-Black Max
b	Code	Function
	R	2 Position Twist-to-Release, Maintained ¹
c	Code	Style
	8	Plastic 1 3/4" Mushroom Head
d	Code	Lamp Type
	W	Non-Illuminated

e	Code	Color
	2	Red ¹
	3	Green
	4	Yellow
	Z	No head
f²	Code	Contact Blocks
	A	1 NO + 1 NC ¹
	B	2 NO + 2 NC ¹
	C	3 NO + 3 NC ¹
	D	4 NO + 4 NC ¹
	E	1 NC (LB)
	F	2 NO
	G	2NC ¹
	H	1NO (EM)
	J	1 NC ¹
	K	1 NO

¹ EMERGENCY-STOP control devices according to IEC 60947-5-5 when provided with red operating head and positively driven NC contact blocks. Positive opening contacts according to IEC 60947-5-1, Appendix K.

² For operator without contact blocks leave position f blank.

30mm Water, Oil Tight & Corrosion Resistant – Class 52

Illuminated Twist-to-Release

Selection Guide

2 Position Twist-to-Release Mushroom Head Devices - Illuminated

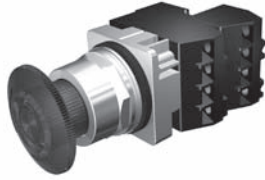

Plastic 1 3/4" Mushroom Head - Chrome



Plastic 1 3/4" Mushroom Head - Black Max

Part Number	52	a	R	8	d	e	f	g
-------------	-----------	----------	----------	----------	----------	----------	----------	----------

Finish	Style	Voltage	Bulb Type	Color	Contacts	Part Number
Chrome	Plastic 1 3/4" Mushroom Head	24V	LED	Red	1 NO - 1 NC	52PR8DRAB
Chrome	Plastic 1 3/4" Mushroom Head	120V	Incandescent	Red	1 NO - 1 NC	52PR8ERA
Chrome	Plastic 1 3/4" Mushroom Head	120V	LED	Red	1 NO - 1 NC	52PR8GRAB

Readily available items are in **bold**.
This is a small representation of stocked items.

a	Code	Finish
	P	Chrome-Command 52
	B	Epoxy Coated-Black Max

b	Code	Function
	R	2 Position Twist-to-Release, Maintained

c	Code	Style
	8	Plastic 1 3/4" Mushroom Head

d	Code	Operation	
		Full Voltage ² (AC/DC)	
		Incandescent	LED ³
	B	6-8V	6V
	C	12-13V	—
	D	24-28V	24-28V
	E	120V	120V
	F	—	240V
		Transformer ²	
	G	120V AC	
	H	240V AC	
	J	480V AC	
	K	600V AC	

e	Code	Color
	R	Red ¹
	S	Green
	T	Amber
	Z	No head

f	Code	Contact Blocks
	A	1 NO + 1 NC ¹
	B	2 NO + 2 NC ¹
	C	3 NO + 3 NC ¹
	D	4 NO + 4 NC ¹
	E	1 NC (LB)
	F	2 NO
	G	2NC ¹
	H	1NO (EM)
	J	1 NC ¹
K	1 NO	

g	Code	Bulb Type
	Blank	Incandescent
	B	LED
	Y	Super-Bright LED ⁴

1 EMERGENCY-STOP control devices according to IEC 60947-5-5 when provided with red operating head and positively driven NC contact blocks. Positive opening contacts according to IEC 60947-5-1, Appendix K, Molded bodies.

2 Default bulb type is incandescent. For LED options, append field g. LED option not available on units sold "no head."

3 LED voltages apply to table g option code B and Y. 6V and 120V are currently AC only. Replaced by AC/DC rated versions end of 2014.

4 Not available in 240V.

30mm Water, Oil Tight & Corrosion Resistant – Class 52

Indicator Light

Selection Guide

Indicator Light



Plastic Lens

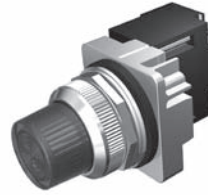

Glass Lens

Part Number	52	<u> </u> a	<u> </u> L b	<u> </u> c	<u> </u> d	<u> </u> e	<u> </u> f
--------------------	-----------	-------------------------	-------------------------------------	-------------------------	-------------------------	-------------------------	-------------------------

a	Code	Finish
	P	Chrome-Command 52
	B	Epoxy Coated-Black Max

b	Code	Type
	L	Indicator Light

c	Code	Style
	4	Plastic Lens
	5	Glass Lens

d	Code	Operation	
		Full Voltage¹ (AC/DC)	
		Incandescent	LED²
	B	6-8V	6V
	C	12-13V	—
	D	24-28V	24-28V
	E	120V	120V
	F	—	240V
		Transformer¹	
	G	120V AC	
	H	240V AC	
	J	480V AC	
	K	600V AC	

e	Code	Color
	2	Red
	3	Green
	5	Blue
	7	All Colors
	9	Amber
	A	Clear
	B	White
	N	No Lens

f	Code	Bulb Type
	Blank	Incandescent
	XB	LED
	XY	Super-Bright LED ³

1 Default bulb type is incandescent. For LED options, append field f. LED option not available on units sold "No Lens".
 2 LED voltages apply to table f option code XB and XY. 6V, 24V (Super Bright only) and 120V are currently AC only. Replaced by AC/DC rated versions end of 2014.
 3 Not available in 240V.

Selection Tables

Indicator Light

Type	Lamp Type	Voltage	Color	Plastic Lens	
				Chrome	Black Max
Full Voltage (AC/DC)	LED	24V	Red	52PL4D2XB	52BL4D2XB
			Green	52PL4D3XB	52BL4D3XB
			Blue	52PL4D5XB	52BL4D5XB
			Amber	52PL4D9XB	52BL4D9XB
			White	52PL4DBXB	52BL4DBXB
		120V	Red	52PL4E2XB	52BL4E2XB
			Green	52PL4E3XB	52BL4E3XB
			Amber	52PL4E9XB	52BL4E9XB
			Clear	52PL4EAXB	52BL4EAXB
			White	52PL4EBXB	52BL4EBXB
	Incandescent	24V	Red	52PL4D2	52BL4D2
			Green	52PL4D3	52BL4D3
			Blue	52PL4D5	52BL4D5
			Amber	52PL4D9	52BL4D9
			White	52PL4DB	52BL4DB
		No Lens	52PL4DN	52BL4DN	
		120V	Red	52PL4E2	52BL4E2
			Green	52PL4E3	52BL4E3
Amber	52PL4E9		52BL4E9		
No Lens	52PL4EN	52BL4EN			
Transformer (AC)	LED	120V	Red	52PL4G2XB	52BL4G2XB
			Green	52PL4G3XB	52BL4G3XB
			Amber	52PL4G9XB	52BL4G9XB
			White	52PL4GBXB	52BL4GBXB
		480V	Red	52PL4J2XB	52BL4J2XB
			Green	52PL4J3XB	52BL4J3XB
			White	52PL4JBXB	52BL4JBXB
			No Lens	52PL4JN	52BL4JN
	Incandescent	120V	Red	52PL4G2	52BL4G2
			Green	52PL4G3	52BL4G3
			Amber	52PL4G9	52BL4G9
			White	52PL4GB	52BL4GB
			No Lens	52PL4GN	52BL4GN
		240V	Red	52PL4H2	52BL4H2
			Green	52PL4H3	52BL4H3
			No Lens	52PL4HN	52BL4HN
		480V	Red	52PL4J2	52BL4J2
			Green	52PL4J3	52BL4J3
Amber	52PL4J9	52BL4J9			

Readily available items are in **bold**.
This is a small representation of stocked items.

30mm Water, Oil Tight & Corrosion Resistant – Class 52

Illuminated Push Button & Push-to-Test

Selection Guide

Push Button & Push-to-Test - Illuminated

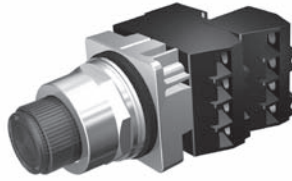

Extended Lens



Flush Lens

Part Number	52	<u> </u>	<u> </u>	<u> </u>	<u> </u>	<u> </u>	<u> </u>	<u> </u>
		a	T	c	d	e	f	g

a	Code	Finish
	P	Chrome-Command 52
	B	Epoxy Coated-Black Max

b	Code	Function
	T	Illuminated Push Button / Push-to-Test ¹

c	Code	Style
	6	Extended Lens
	8	Flush Lens ²

d	Code	Operation	
		Full Voltage ³ (AC/DC)	
		Incandescent	LED ⁴
	B	6-8V	6V
	C	12-13V	—
	D	24-28V	24-28V
	E	120V	120V
	F	—	240V
		Transformer ³	
	G	120V AC	
H	240V AC		
J	480V AC		
K	600V AC		

e	Code	Color
	2	Red
	3	Green
	5	Blue
	7	All Colors
	9	Amber
	A	Clear
	B	White
N	No Lens	

f	Code	Contact Blocks
	A	1 NO - 1 NC
	B	2 NO + 2 NC
	C	3 NO + 3 NC
	D	4 NO + 4 NC
	E	1 NC (LB)
	F	2 NO
	G	2 NC
	H	1NO (EM)
	J	1 NC
	K	1 NO

g	Code	Bulb Type
	Blank	Incandescent
	B	LED
	Y	Super-Bright LED ⁵

1 For push-to-test functionality, wire according to wiring diagram below.
 2 Products available fall 2014.

3 Default bulb type is incandescent. For LED options, append field g.
 LED option not available on units sold "No Lens".
 4 LED voltages apply to table g option code B and Y.
 6V and 120V are currently AC only. Replaced by AC/DC rated versions end of 2014.
 5 Not available in 240V.

Wiring Diagrams

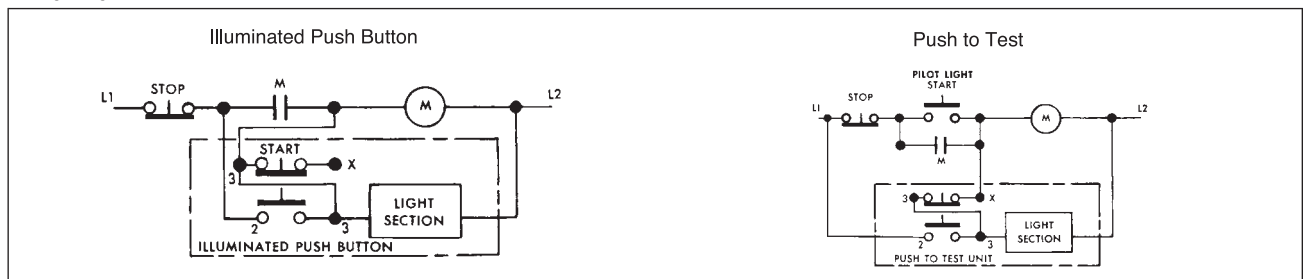

Selection Tables

Push Button & Push-to-Test - Illuminated

Type	Lamp Type	Voltage	Color	Contacts	Extended Lens	
					Chrome	Black Max
Full Voltage (AC/DC)	LED	24V	Red	1 NO - 1 NC	52PT6D2AB	52BT6D2AB
			Green	1 NO - 1 NC	52PT6D3AB	52BT6D3AB
			Blue	1 NO - 1 NC	52PT6D5AB	52BT6D5AB
			Amber	1 NO - 1 NC	52PT6D9AB	52BT6D9AB
			White	1 NO - 1 NC	52PT6DBAB	52BT6DBAB
	Incandescent	24V	Red	1 NO - 1 NC	52PT6E2AB	52BT6E2AB
			Green	1 NO - 1 NC	52PT6E3AB	52BT6E3AB
			Red	1 NO - 1 NC	52PT6D2A	52BT6D2A
			Green	1 NO - 1 NC	52PT6D3A	52BT6D3A
			Blue	1 NO - 1 NC	52PT6D5A	52BT6D5A
Transformer (AC)	LED	120V	Amber	1 NO - 1 NC	52PT6D9A	52BT6D9A
			White	1 NO - 1 NC	52PT6DBA	52BT6DBA
			Red	1 NO - 1 NC	52PT6E2A	52BT6E2A
			Green	1 NO - 1 NC	52PT6E3A	52BT6E3A
			Red	1 NO - 1 NC	52PT6G2AB	52BT6G2AB
	Incandescent	120V	Green	1 NO - 1 NC	52PT6G3AB	52BT6G3AB
			Amber	1 NO - 1 NC	52PT6G9AB	52BT6G9AB
			White	1 NO - 1 NC	52PT6GBAB	52BT6GBAB
			Red	1 NO - 1 NC	52PT6H2AB	52BT6H2AB
			Green	1 NO - 1 NC	52PT6H3AB	52BT6H3AB
Incandescent	120V	Red	1 NO - 1 NC	52PT6G2A	52BT6G2A	
		Green	1 NO - 1 NC	52PT6G3A	52BT6G3A	
		Amber	1 NO - 1 NC	52PT6G9A	52BT6G9A	
		White	1 NO - 1 NC	52PT6GBA	52BT6GBA	
		No Lens	1 NO - 1 NC	52PT6GNA	52BT6GNA	
Incandescent	240V	Green	1 NO - 1 NC	52PT6H3A	52BT6H3A	
		Clear	1 NO - 1 NC	52PT6JAA	52BT6JAA	

Readily available items are in **bold**.
This is a small representation of stocked items.

30mm Water, Oil Tight & Corrosion Resistant – Class 52

Illuminated Push Button

Selection Guide

Push Button Mushroom Head Devices – Illuminated⁴

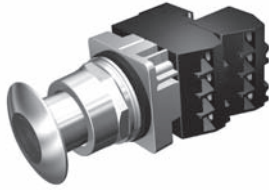

Mushroom Head Metal Ø 1 3/4"



Mushroom Head Plastic Ø 2 1/2"

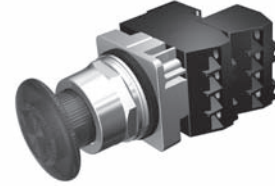

Mushroom Head Plastic Ø 1 3/4"

Part Number	52	<u> </u> a	<u> </u> T	<u> </u> 9	<u> </u> d	<u> </u> e	<u> </u> f	<u> </u> g
-------------	-----------	-------------------------	-------------------------	-------------------------	-------------------------	-------------------------	-------------------------	-------------------------

a	Code	Finish
	P	Chrome-Command 52
B	Epoxy Coated-Black Max	

b	Code	Type
	T	Push Button Operator

c	Code	Function
	9	2 positions – momentary in

d	Code	Operation	
		Full Voltage ² (AC/DC)	
		Incandescent	LED ³
B		6-8V	6V
C		12-13V	—
D		24-28V	24-28V
E		120V	120V
F		—	240V
		Transformer ²	
G		120V AC	
H		240V AC	
J		480V AC	
K		600V AC	

e	Code	Style / Color
2		Red ¹
3		Green
5		Blue
9		Amber
A		Clear
B		White
		Mushroom Head Plastic Ø 1 3/4" (44.5 mm)
R		Red
S		Green
T		Amber
		Mushroom Head Plastic Ø 2 1/2" (63.5mm)
D		Red ¹
E		Green
F		Amber
		No Head (full voltage & transformer only)
Z		No head

f	Code	Contact Blocks
	A	1 NO + 1 NC
B	2 NO + 2 NC	
C	3 NO + 3 NC	
D	4 NO + 4 NC	
E	1 NC (LB)	
F	2 NO	
G	2 NC	
H	1NO (EM)	
J	1 NC	
K	1 NO	

g	Code	Bulb Type
	Blank	Incandescent
B	LED	
Y	Super-Bright LED ⁵	

1 Positive opening according to IEC 60947-5-1, Appendix K.
 2 Default bulb type is incandescent. For LED options, append field g. LED option not available on units sold "no head".
 3 LED voltages apply to table g option code B and Y. 6V and 120V are currently AC only. Replaced by AC/DC rated versions end of 2014.
 4 Products available fall 2014.
 5 Not available in 240V.

30mm Water, Oil Tight & Corrosion Resistant – Class 52

Illuminated Selector Switches

Selection Guide

Selector Switches – Illuminated

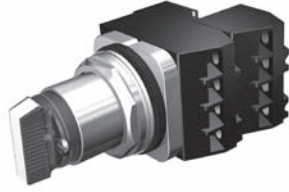

Short Lever – Chrome



Short Lever – Black Max

Part Number	52	S	7							
		a	b	c	d	e	f	g	h	i

Finish	Style	Cam Type	Function	Color	Contacts	Part Number
Chrome	Maintained	2 Position: CAM A	24-28V AC/DC	No Insert	None	52SA7ADN
Chrome	Maintained	2 Position: CAM A	120V AC (Transformer)	No Insert	None	52SA7AGN
Chrome	Maintained	3 Position: CAM C	120V AC	No Insert	None	52SA7CGN

Readily available items are in **bold**.
This is a small representation of stocked items.

a	Code	Type
	S	Selector Switch

b	Code	Finish
	A	Chrome - Command 52
	X	Epoxy Coated - Black Max

c	Code	Style
	7	Maintained

d	Code	Function
	A	2 Position: CAM A
	B	3 Position: CAM B
	C	3 Position: CAM C

e	Code	Operation	
		Full Voltage ¹ (AC/DC)	
		Incandescent	LED ²
	B	6-8V	6V
	C	12-13V	—
	D	24-28V	24-28V
	E	120V	120V
	F	—	240V
		Transformer ¹	
	G	120V AC	
	H	240V AC	
	J	480V AC	
	K	600V AC	

f	Code	Color
	2	Red
	3	Green
	5	Blue
	9	Amber
	A	Clear
	N	No Insert

g	Code	Contact Blocks
	A	1 NO - 1 NC
	E	1 NC (LB)
	H	1 NO (EM)
	J	1 NC
	K	1 NO

h	Code	Contact Quantity & Location	
		A CAM & C CAM Left	B CAM Right
	0	1	—
	1	—	1
	3	2	—
	4	—	2

i	Code	Bulb Type
	Blank	Incandescent
	B	LED
	Y	Super-Bright LED ³

¹ Default bulb type is incandescent. For LED options, append field i.
LED option not available on units sold "no head".

² LED voltages apply to table i option code B and Y.
6V and 120V are currently AC only. Replaced by AC/DC rated versions end of 2014.

³ Not available in 240V.

For CAM selection see page 10/216.

30mm Water, Oil Tight & Corrosion Resistant – Class 52

Non-Illuminated Selector Switch

Selection Guide

Selector Switch – Non-Illuminated

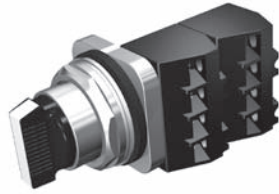

Short Lever



Long Lever

Part Number	52	S	2					
	a	b	c	d	e	f	g²	h²

a	Code	Type
	S	Selector Switch

b	Code	Finish
	A	Chrome - Short Lever
	B	Chrome - Long Lever
	X	BlackMax - Short Lever
	W	BlackMax - Long Lever

c	Code	Style
	2	Non-Illuminated

d	Code	Function
	A	2 Position: CAM A
	B	3 Position: CAM B
	C	3 Position: CAM C ¹
	D	3 Position: CAM D
	E	3 Position: CAM E
	G	3 Position: CAM G
	H	4 Position: CAM H

e	Code	Type
		2 Position
		Maintained Spring Return
	A	All —
	C	Left Right
		3 Position
		Maintained Spring Return
	A	All —
	B	Center, Right Left
	C	Center, Left Right
	D	Center Left, Right
		4 Position
		Maintained Position Spring Return
	A	All —

f	Code	Color
	2	Red
	3	Green
	4	Yellow
	5	Blue
	6	Gray
	8	Orange
	B	White
	N	No Insert (Black)

g ²	Code	Contact Blocks
	A	1 NO - 1 NC
	E	1 NC (LB)
	H	1 NO (EM)
	J	1 NC
	K	1 NO

h ²	Code	Contact Quantity & Location	
		Left	Right
	0	1	—
	1	—	1
	2	1	1
	3	2	—
	4	—	2
	5	2	1
	6	1	2
	7	2	2
	8	3	—
	9	—	3

¹ C CAM on spring return selectors is limited to 4 contact blocks.
For CAM selection see page 10/216.

² For operator without contact blocks leave positions g and h blank.

30mm Water, Oil Tight & Corrosion Resistant – Class 52

Non-Illuminated Selector Switch

Selector Switch, Non-Illuminated¹⁾

Contact Type	Contact	Switch Position		Type M = Maintained S = Spring Return	Chrome		Black Max	
		Left	Right		Short Lever	Long Lever	Short Lever	Long Lever
					2-Position Operator			
No Contacts	—	—	—	M M	52SA2AAB	52SB2AAB	52SX2AAB	52SW2AAB
				M<---S	52SA2ACB	52SB2ACB	52SX2ACB	52SW2ACB
1 N.O.	A	O	X	M M	52SA2AABK1	52SB2AABK1	52SX2AABK1	52SW2AABK1
				M<---S	52SA2ACBK1	52SB2ACBK1	52SX2ACBK1	52SW2ACBK1
1 N.O.	A	O	X	M M	52SA2AABA1	52SB2AABA1	52SX2AABA1	52SW2AABA1
1 N.C.	B	X	O	M<---S	52SA2ACBA1	52SB2ACBA1	52SX2ACBA1	52SW2ACBA1

Contact Type	Contact	Switch Position			Type M = Maintained S = Spring Return	Chrome		Black Max	
		Left	Center	Right		Short Lever	Long Lever	Short Lever	Long Lever
					3-Position Operator				
No Contacts	—	—	—	—	M M M	52SA2CAB	52SB2CAB	52SX2CAB	52SW2CAB
					M M M	52SA2BAB	52SB2BAB	52SX2BAB	52SW2BAB
					S--->M M	52SA2BBB	52SB2BBB	52SX2BBB	52SW2BBB
					M M<----S	52SA2BCB	52SB2BCB	52SX2BCB	52SW2BCB
					S--->M<---S	52SA2BDB	52SB2BDB	52SX2BDB	52SW2BDB
1 N.O.	A	O	O	X	M M M	52SA2CABA1	52SB2CABA1	52SX2CABA1	52SW2CABA1
					S--->M M	52SA2CBBA1	52SB2CBBA1	52SX2CBBA1	52SW2CBBA1
1 N.C.	B	X	O	O	M M<----S	52SA2CCBA1	52SB2CCBA1	52SX2CCBA1	52SW2CCBA1
					S--->M<---S	52SA2CDBA1	52SB2CDBA1	52SX2CDBA1	52SW2CDBA1
1 N.O.	A	O	O	X	M M M	52SA2CABA2	52SB2CABA2	52SX2CABA2	52SW2CABA2
1 N.C.	B	X	O	O	S--->M M	52SA2CBBA2	52SB2CBBA2	52SX2CBBA2	52SW2CBBA2
1 N.O.	C	O	O	X	M M<----S	52SA2CCBA2	52SB2CCBA2	52SX2CCBA2	52SW2CCBA2
1 N.C.	D	X	O	O	S--->M<---S	52SA2CDBA2	52SB2CDBA2	52SX2CDBA2	52SW2CDBA2
1 N.O.	A	O	O	X	M M M	52SA2GABJ2K1	52SB2GABJ2K1	52SX2GABJ2K1	52SW2GABJ2K1
1 N.C.	B	X	O	O	M M M	52SA2GABJ2K1	52SB2GABJ2K1	52SX2GABJ2K1	52SW2GABJ2K1
1 N.C.	C	O	X	O	M M M	52SA2GABJ2K1	52SB2GABJ2K1	52SX2GABJ2K1	52SW2GABJ2K1

Contact Type	Contact	Switch Position				Type M = Maintained S = Spring Return	Chrome		Black Max	
		Left	Center	Right	Center		Short Lever	Long Lever	Short Lever	Long Lever
					4-Position Operator					
No Contacts	—	—	—	—	—	M M M M	52SA2HAB	52SB2HAB	52SX2HAB	52SW2HAB
1 N.O.	A	X	O	O	O	M M M M	52SA2HABJ2K1	52SB2HABJ2K1	52SX2HABJ2K1	52SW2HABJ2K1
1 N.C.	B	O	X	O	O	M M M M	52SA2HABJ2K1	52SB2HABJ2K1	52SX2HABJ2K1	52SW2HABJ2K1
1 N.C.	C	O	O	X	O	M M M M	52SA2HABJ2K1	52SB2HABJ2K1	52SX2HABJ2K1	52SW2HABJ2K1
1 N.O.	A	O	O	O	X	M M M M	52SA2HABJ2K2	52SB2HABJ2K2	52SX2HABJ2K2	52SW2HABJ2K2
1 N.O.	B	X	O	O	O	M M M M	52SA2HABJ2K2	52SB2HABJ2K2	52SX2HABJ2K2	52SW2HABJ2K2
1 N.C.	C	O	X	O	O	M M M M	52SA2HABJ2K2	52SB2HABJ2K2	52SX2HABJ2K2	52SW2HABJ2K2
1 N.C.	D	O	O	X	O	M M M M	52SA2HABJ2K2	52SB2HABJ2K2	52SX2HABJ2K2	52SW2HABJ2K2

Note: X = Closed / O = Open

1) Readily available items are in **bold**.

This is a small representation of stocked items.

30mm Water, Oil Tight & Corrosion Resistant – Class 52

Keyed Selector Switch

Selection Guide

Keyed Selector Switch

Part Number	52	S	C						
		a	b	c	d	e	f³	g³	h

a	Code	Type
	S	Selector Switch

b	Code	Finish
	C	Chrome – Command 52

c	Code	Style
	5	Non-Standard Lock/Key ^{1a}
	6	Standard Lock/Key

d	Code	Function
	A	2 Position: CAM A
	B	3 Position: CAM B
	C	3 Position: CAM C ²
	D	3 Position: CAM D
	E	3 Position: CAM E
	G	3 Position: CAM G
	H	4 Position: CAM H

e	Code	Lock Type		
		2 Position		
		Maintained / Spring Return	Key Removal	
			Left	Right
	E	All Maintained	X	X
	F	All Maintained	X	—
	G	All Maintained	—	X
	X	Spring from Right	X	—

		3 Position				
		Maintained Position	Spring Return	Key Removal		
				Left	Center	Right
	E	All	—	X	X	X
	F	All	—	X	—	—
	G	All	—	—	—	X
	H	All	—	—	X	—
	J	All	—	X	—	X
	K	All	—	X	X	—
	M	All	—	—	X	X
	T	Center, Right	Left	—	X	—
	U	Left, Center	Right	—	X	—
	V	Center	Left, Right	—	X	—
	W	Center, Right	Left	—	—	X
	Y	Center, Right	Left	—	X	X
	Z	Left, Center	Right	X	X	X

		4 Position				
		Maintained Position	Key Removal			
			Left	Left Center	Right Center	Right
	E	All	X	X	X	X
	F	All	X	—	—	—
	G	All	—	—	—	X

f ³	Code	Contact Blocks
	A	1 NO - 1 NC
	J	1 NC
	K	1 NO
	E	1 NC (LB)
	H	1 NO (EM)

g ³	Code	Contact Quantity & Location	
		Left	Right
	0	1	—
	1	—	1
	2	1	1
	3	2	—
	4	—	2
	5	2	1
	6	1	2
	7	2	2
	8	3	—
	9	—	3

h	Code	Key Type ^{1b}
	Blank	501CH
	X298	550CH
	X299	549CH
	X300	548CH
	X301	547CH
	X302	506CH

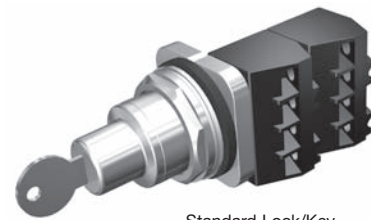

Standard Lock/Key

1a. See page 10/213 for replacement keys, and up-to 15 additional uniquely keyed M - Series Lock Options available for use with the 52SC6 key-operated selector switches.

1b. To order the specific lock types shown in table h, simply append the corresponding "X" suffix to a standard part number (Ordering Example: 52SC6AEX298).

Note: Same list price applies as standard keyed locks.

2. C CAM on spring return selectors is limited to 4 contact blocks. For CAM selection see page 10/216.

3 For operator without contact blocks leave positions f and g blank.

30mm Water, Oil Tight & Corrosion Resistant – Class 52

Keyed Selector Switch

Key-operated Selector Switch, Non-Illuminated¹⁾

Contact Type	Contact	Switch Position		Type	Key Removal	
		Left	Right	M = Maintained S = Spring Return	Left	Both
					2-Position Operator	
No Contacts	—	—	—	M M	52SC6AF	52SC6AE
				M<---S	52SC6AX	—
1 N.O.	A	O	X	M M	52SC6AFK1	52SC6AEK1
				M<---S	52SC6AXK1	—
1 N.O.	A	O	X	M M	52SC6AFA1	52SC6AEA1
1 N.C.	B	X	O	M<---S	52SC6AXA1	—

Contact Type	Contact	Switch Position			Type	Key Removal							
		Left	Center	Right	M = Maintained S = Spring Return	Left	Right	Center	Left & Center	Left & Right	Center & Right	All Positions	
						3-Position Operator							
No Contacts	—	—	—	—	M M M	52SC6CF	52SC6CG	52SC6CH	52SC6CK	52SC6CJ	52SC6CM	52SC6CE	
					M M M	52SC6BF	52SC6BG	52SC6BH	52SC6BK	52SC6BJ	52SC6BM	52SC6BE	
					S---M	M	—	52SC6BW	52SC6BT	—	—	52SC6BY	—
					M M<----S	—	—	52SC6BU	52SC6BZ	—	—	—	—
					S---M<---S	—	—	52SC6BV	—	—	—	—	—
1 N.O.	A	O	O	X	M M M	52SC6CFA1	52SC6CGA1	52SC6CHA1	52SC6CKA1	52SC6CJA1	52SC6CMA1	52SC6CEA1	
					S---M	M	—	52SC6CWA1	52SC6CTA1	—	—	52SC6CYA1	—
					M M<----S	—	—	52SC6CUA1	52SC6CZA1	—	—	—	—
1 N.C.	B	X	O	O	S---M<---S	—	—	52SC6CVA1	—	—	—	—	
					M M M	52SC6CFA2	52SC6CGA2	52SC6CHA2	52SC6CKA2	52SC6CJA2	52SC6CMA2	52SC6CEA2	
1 N.C.	B	X	O	O	S---M	M	—	52SC6CWA2	52SC6CTA2	—	—	52SC6CYA2	—
1 N.O.	C	O	O	X	M M<----S	—	—	52SC6CUA2	52SC6CZA2	—	—	—	
1 N.C.	D	X	O	O	S---M<---S	—	—	52SC6CVA2	—	—	—	—	
1 N.O.	A	O	O	X	M M M	52SC6GFJ2K1	52SC6GGJ2K1	52SC6GHJ2K1	52SC6GKJ2K1	52SC6GJ2K1	52SC6GMJ2K1	52SC6GEJ2K1	
1 N.C.	B	X	O	O	M M M	52SC6GFJ2K1	52SC6GGJ2K1	52SC6GHJ2K1	52SC6GKJ2K1	52SC6GJ2K1	52SC6GMJ2K1	52SC6GEJ2K1	
1 N.C.	C	O	X	O	M M M	52SC6GFJ2K1	52SC6GGJ2K1	52SC6GHJ2K1	52SC6GKJ2K1	52SC6GJ2K1	52SC6GMJ2K1	52SC6GEJ2K1	

Contact Type	Contact	Switch Position				Type	Key Removal	
		Left	Left Center	Right Center	Right	M = Maintained S = Spring Return	Right	All Positions
							4-Position Operator	
No Contacts	—	—	—	—	—	M M M M	52SC6HG	52SC6HE
1 N.O.	A	X	O	O	O	M M M M	52SC6HGJ2K1	52SC6HEJ2K1
1 N.C.	B	O	X	O	O	M M M M	52SC6HGJ2K1	52SC6HEJ2K1
1 N.C.	C	O	O	X	O	M M M M	52SC6HGJ2K1	52SC6HEJ2K1
1 N.O.	A	O	O	O	X	M M M M	52SC6HGJ2K2	52SC6HEJ2K2
1 N.O.	B	X	O	O	O	M M M M	52SC6HGJ2K2	52SC6HEJ2K2
1 N.C.	C	O	X	O	O	M M M M	52SC6HGJ2K2	52SC6HEJ2K2
1 N.C.	D	O	O	X	O	M M M M	52SC6HGJ2K2	52SC6HEJ2K2

Note: X = Closed / O = Open

All Operators listed above are furnished with Lock No. 501CH

1) Readily available items are in bold.

This is a small representation of stocked items.

Actuators and Indicators, Customized Designs

Special locks

Options

Special locks for key-operated switches

Siemens Key-Operated Selector Switches beginning with 51SA6 or 52SC6 can be optionally ordered with the 15 uniquely keyed M-Series Locks by appending the corresponding "X" suffixes from the table below to the catalog number. (Ordering Example for Lock Number M705: 52SC6CEX705).

Note: Pricing for M - Series Locks on this page are slightly higher than standard lock types.

Suffix Code	Lock Number
X705	M705
X709	M709
X713	M713
X714	M714
X715	M715
X723	M723
X725	M725
X738	M738
X749	M749
X750	M750
X757	M757
X766	M766
X779	M779
X782	M782
X795	M795

Spare Keys for Key-Operated Selector Switches

Spare Key	Part Number
550CH (1 Key)	52KEY-550CH
549CH (1 Key)	52KEY-549CH
548CH (1 Key)	52KEY-548CH
547CH (1 Key)	52KEY-547CH
501CH (1 Key)	52KEY-501CH
506CH (1 Key)	52KEY-506CH
M703 (1 Key)	52KEY-M703
M705 (1 Key)	52KEY-M705
M706 (1 Key)	52KEY-M706
M709 (1 Key)	52KEY-M709
M712 (1 Key)	52KEY-M712
M713 (1 Key)	52KEY-M713
M714 (1 Key)	52KEY-M714
M715 (1 Key)	52KEY-M715
M716 (1 Key)	52KEY-M716
M717 (1 Key)	52KEY-M717
M723 (1 Key)	52KEY-M723
M725 (1 Key)	52KEY-M725
M728 (1 Key)	52KEY-M728
M730 (1 Key)	52KEY-M730
M735 (1 Key)	52KEY-M735
M736 (1 Key)	52KEY-M736
M738 (1 Key)	52KEY-M738
M747 (1 Key)	52KEY-M747
M749 (1 Key)	52KEY-M749
M750 (1 Key)	52KEY-M750
M752 (1 Key)	52KEY-M752
M753 (1 Key)	52KEY-M753
M756 (1 Key)	52KEY-M756
M757 (1 Key)	52KEY-M757
M759 (1 Key)	52KEY-M759
M766 (1 Key)	52KEY-M766
M769 (1 Key)	52KEY-M769
M771 (1 Key)	52KEY-M771
M779 (1 Key)	52KEY-M779
M784 (1 Key)	52KEY-M784
M790 (1 Key)	52KEY-M790
M795 (1 Key)	52KEY-M795
M700 (1 Key)	52KEY-M700
M701 (1 Key)	52KEY-M701
M702 (1 Key)	52KEY-M702
M704 (1 Key)	52KEY-M704
M705 (1 Key)	52KEY-M705
M707 (1 Key)	52KEY-M707
M711 (1 Key)	52KEY-M711
M713 (1 Key)	52KEY-M713
M715 (1 Key)	52KEY-M715
M782 (1 Key)	52KEY-M782
M795 (1 Key)	52KEY-M795

30mm Water, Oil Tight & Corrosion Resistant – Class 52

Selector Push Button

Selection Guide

Selector Push Button

Part Number	52	S a	A b	c	d	e	f ¹
--------------------	-----------	---------------	---------------	---	---	---	----------------

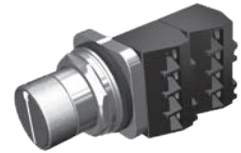

Selector Push Buttons

Finish	Style	Function	Color	Contacts	Part Number
Chrome	Flush Selector Push Button	2 Position CAM Q	Black	None	52SA3Q1
Chrome	Flush Selector Push Button	2 Position CAM R	Black	None	52SA3R1
Chrome	Flush Selector Push Button	2 Position CAM P	Black	None	52SA3P1

Readily available items are in **bold**.
This is a small representation of stocked items.





a	Code	Type
	S	Selector Push Buttons
b	Code	Finish
	A	Chrome - Command 52
c	Code	Style
	3	Flush Button
	4	Extended Button - 1/2"

d	Code	Function
	P	2 Position: CAM P
	Q	2 Position: CAM Q
	R	2 Position: CAM R
e	Code	Color
	1	Black
	2	Red

f ¹	Code		Contact Blocks						Contact Blocks	Mounting Position
			CAM P (2 Selector Position)							
			Left		Center		Right			
			N	D	N/A	N/A	N	D		
	J0		X	O	—	—	O	O	NC	Left
	K0		O	X	—	—	X	X	NO	Left
			CAM Q (2 Selector Position)							
			N	D	N/A	N/A	N	D		
	J0		X	X	—	—	O	O	NC	Left
	J1		X	O	—	—	O	O	NC	Right
	K0		O	O	—	—	O	X	NO	Left
	K1		O	X	—	—	O	X	NO	Right
			CAM R (2 Selector Position)							
			N	D	N/A	N/A	N	D		
	J0		X	X	—	—	X	O	NC	Left
	J1		X	O	—	—	X	X	NC	Left
	K0		O	O	—	—	O	X	NO	Right
	K1		O	X	—	—	O	O	NO	Right
			CAM S (3 Selector Position)							
			N	D	N	D	N	D		
	J0		X	O	O	O	O	O	NC	Left
	J1		X	O	X	X	O	O	NC	Right
	K0		O	O	O	X	O	X	NO	Left
	K1		O	X	O	O	O	X	NO	Right

Note: X = Closed / O = Open 1 For operator without contact blocks leave position f blank

Selection and ordering data

	Version	Ohms / color	Order no.	Pack
	Potentiometer operator	50	52MA3B01	1
	2 Watts, 500 V AC/DC (NEMA Type 4)	150	52MA3B03	
		250	52MA3B04	
		500	52MA3B06	
		750	52MA3B07	
		1 K	52MA3B08	
		2.5 K	52MA3B10	
		5 K	52MA3B12	
		10 K	52MA3B14	
		15 K	52MA3B15	
		25 K	52MA3B16	
		50 K	52MA3B18	
		100 K	52MA3B20	
		150 K	52MA3B21	
		250 K	52MA3B22	
	500 K	52MA3B24		
	1 M	52MA3B26		
	1.5 M	52MA3B27		
	2 M	52MA3B28		
	5 M	52MA3B31		
	2 Button maintained operator	black (flush) / red (flush)	52MP2A1A2	1
		black (flush) / red (extended)	52MP2A1B2	
		black (flush) / yellow (mushroom)	52MP2A1W4	
		green (flush) / red (flush)	52MP2A3A2	
		green (flush) / red (extended)	52MP2A3B2	
		green (flush) / red (mushroom)	52MP2A3W2	
		green (flush) / green (mushroom)	52MP2A3W3	
	Button remains depressed when pushed	less caps	52MP2	
	Wobble stick 2.5" operator	red	52ABW2 ^①	1
	For use with 52BAJ (NC) contact block	green	52ABW3 ^①	
		grey	52ABW6 ^①	
	Maintained toggle operator		52ABT	1

① For use with 52BAJ (NC) contact block

Cam selection

Selection and ordering data

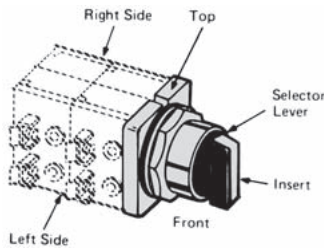

Ordering Information

- Contact blocks are ordered separately, [see page 10/216](#)
- Determine which table to use based upon the type of selector (non-illum selector switch-top, illum selector switch-middle, and selector pushbutton-bottom).
- Find the correct number of selector positions (2, 3 or 4 positions).
- Select the contact operation required for each selector position. X indicates the contacts are closed, while O indicates the contacts are open. (For the selector pushbutton, N=normal and D=depressed).
- Contact block must be assembled in position shown for each circuit application.
- Identify the CAM letter required for the chosen contact operation (only 1 CAM can be used per selector switch or selector pushbutton).
- Contact blocks must be assembled in the position shown for each circuit application. The mounting position is viewed from the front of the device.

Ordering CAMs D, E or G

- CAM D, E or G may be ordered at the same price by changing the 6th character of the selector catalog number. Example: Selector with D cam **52SX2DAB**.

Size Requirements

- C CAM on spring return selectors is limited to 4 contact blocks.
- Selector operators in enclosures are limited to depth of 1 contact block. (2 blocks wide).

Non-illuminated and keyed selector switches (viewed from front)

2 Selector Positions				Contact Blocks	CAM	Mounting		
Left		Right	Left			Right		
X		O		NC (52BAJ)	A	L	or R	
O		X		NO (52BAK)	A	L	or R	
3 Selector Positions				Contact Blocks	CAM	Mounting		
Left	Center	Right	Left			Right		
X		O		NO (52BAK)	B		R	
O		X		NO (52BAK)	B	L		
X	X	O		NC (52BAJ)	B	L		
O	X	X		NC (52BAJ)	B		R	
X	O	X		2NO (2-52BAK)	B	L	and R	
X	O	O		NC (52BAJ)	C	L	or R	
O	O	X		NO (52BAK)	C	L	or R	
O	X	O		NC (52BAJ)	D	L	or R	
O	O	X		NO (52BAK)	D	L	or R	
X	O	O		NO (52BAK)	E	L	or R	
O	X	O		NC (52BAJ)	E	L	or R	
X	O	O		NC (52BAJ)	G	L		
O	X	O		NC (52BAJ)	G		R	
O	O	X		NO (52BAK)	G	L	or R	
4 Selector Positions					Contact Blocks	CAM	Mounting	
Left	Left Center	Right Center	Right	Left			Right	
X	O	O	O	NO (52BAK)	H		R	
O	X	O	O	NC (52BAJ)	H	L		
O	O	X	O	NC (52BAJ)	H		R	
O	O	O	X	NO (52BAK)	H	L		

Illuminated selector switches (viewed from front)

2 Selector Positions				Contact Blocks	CAM	Mounting	
Left		Right	Left			Right	
X		O		NC (52BAJ)	A	L	
O		X		NO (52BAK)	A	L	
3 Selector Positions				Contact Blocks	CAM	Mounting	
Left	Center	Right	Left			Right	
O	O	X		NC (52BAJ)	B		R
O	X	O		NO (52BAK)	B		R
X	O	O		NC (52BAJ)	C	L	
O	O	X		NO (52BAK)	C	L	

Selector Pushbuttons (viewed from front)

2 Selector Positions						Contact Blocks	CAM	Mounting	
Left		Right		Left	Right				
N	D	N	D						
X	O	O	O	NC (52BAJ)	Q			L	R
X	X	O	O	NC (52BAJ)	Q	L			
O	X	O	X	NO (52BAK)	Q			L	R
O	O	O	X	NO (52BAK)	Q	L			
X	O	O	O	NC (52BAJ)	P	L	or		R
O	X	X	X	NO (52BAK)	P	L	or		R
X	X	X	O	NC (52BAJ)	R	L			
X	O	X	X	NC (52BAJ)	R				R
O	X	O	O	NO (52BAK)	R				R
O	O	O	X	NO (52BAK)	R	L			
3 Selector Positions						Contact Blocks	CAM	Mounting	
Left		Center		Right					
N	D	N	D	N	D				
X	O	O	O	O	O	NC (52BAJ)	S	L	
X	O	X	X	O	O	NC (52BAJ)	S		R
O	X	O	O	O	X	NO (52BAK)	S		R
O	O	O	X	O	X	NO (52BAK)	S	L	

Selection and ordering data

Assembled Non-illuminated Selector Switches







- Determine contact block and location from above.
- Select block suffix. Ex: **J = 52BAJ**.
- Now select position suffix.
- **1-52BAJ** block mounted on right side, suffix will be **J 1**.
- Additional suffixes allow for multiple quantities and locations.
- Repeat process for next block if required.
- Add list price of blocks to operator list price.
- Consult factory for delivery.

Example 1: X O O
 O O X
 HAND-OFF-AUTO Maintained Switch
 Catalog No **52SA2CAB A 1 = 52A2CABA1**
 (**52BJK** block mounted on right side)

Example 2: X O O **52BAJ (L)**
 O X O **52BAJ (R)**
 O O X **52BAK (L or R) }K1**
 G Cam required
 Catalog No **52SA2GAB J2 K1 = 52SA2GABJ2K1**

Block Suffix	Position Suffix	
	Suffix	Quantity and Location
		Left Right
A = 1 NO - 1 NC, 52BJK	0	1 —
E = NC Late Break, 52BAE	1	— 1
H = NO Early Make, 52BAH	2	1 1
J = NC, 52BAJ	3	2 —
K = NO, 52BAK	4	— 2
	5	2 1
	6	1 2
	7	2 2
	8	3 —
	9	— 3

Selection and ordering data







Version	Suitable for	Color	Order no.
 <p>Flush actuator lens cap The 52RC1 Screw-on style caps shown are used on the new 52BM8 & 52PM8 Pushbutton Operators. To order Snap-on style replacement caps for the old style 52PA8 & 52PX8 Pushbutton Operators change the 4th character from "C" to "A" (i.e. 52RA1A1).</p>	For flush type, non-illuminated pushbuttons bag of 5 caps	black red green yellow blue gray orange kit- all colors	52RC1A1 52RC1A2 52RC1A3 52RC1A4 52RC1A5 52RC1A6 52RC1A8 52RC1AN
 <p>Extended actuator lens cap The 52RC1 Screw-on style caps shown are used on the new 52BM8 & 52PM8 Pushbutton Operators. To order Snap-on style replacement caps for the old style 52PA8 & 52PX8 Pushbutton Operators change the 4th character from "C" to "A" (i.e. 52RA1B1).</p>	For extended type, non-illuminated pushbuttons bag of 5 caps	black red green yellow blue gray orange 1 of each color cap	52RC1B1 52RC1B2 52RC1B3 52RC1B4 52RC1B5 52RC1B6 52RC1B8 52RC1BN
 <p>Mushroom head cap - Plastic set-screw type replacement caps are for discontinued 52PB9 and 52PX9 operators only</p>	For large 2 1/2"(63.5mm) type, set screw non-illuminated mushroom pushbuttons	black red green yellow blue gray orange 1 kit of each color cap	52RB3E1 52RB3E2 52RB3E3 52RB3E4 52RB3E5 52RB3E6 52RB3E8 52RB3EN
	For small 1 5/8"(41.3mm) type, non-illuminated mushroom pushbuttons	black red green yellow blue gray orange 1 of each color cap	52RB3D1 52RB3D2 52RB3D3 52RB3D4 52RB3D5 52RB3D6 52RB3D8 52RB3DN
 <p>Mushroom head cap - Metal set-screw type</p>	For small 1 5/8"(41.3mm) type, set screw non-illuminated mushroom pushbuttons	chrome red green	52RB3FC 52RB3F2 52RB3F3
 <p>Replacement Lens for Indicator Lights</p>	For catalog numbers starting with 52PL or 52BL ^{①②}		
	Plastic	red green blue amber clear white 1 of each color	52RA4S2 52RA4S3 52RA4S5 52RA4S9 52RA4SA 52RA4SB 52RA4SN
	Glass	red green blue amber clear white 1 of each color	52RA4T2 52RA4T3 52RA4T5 52RA4T9 52RA4TA 52RA4TB 52RA4TN
 <p>Replacement Lens for Push to Test/Illuminated Pushbuttons The 52RA5S Raised lens caps shown are used on the 52BT6 & 52PT6 PTT/Illuminated Pushbutton Operators. To order Flush lens caps for the new style 52BT8 & 52PT8 PTT/Illuminated Pushbutton Operators change the 52RA5S prefix to 52RC5P (i.e. 52RC5P2).</p>	For catalog numbers starting with 52PT or 52BT ^③		
	Plastic	red green blue amber clear white	52RA5S2 52RA5S3 52RA5S5 52RA5S9 52RA5SA 52RA5SB

① To order replacement lens for indicator lights starting with 52PA, 52PE, or 52PX, change the 6th digit to P for plastic and G for glass.

② It is possible to retrofit catalog numbers starting with 52PA, 52PE and 52PX with the replacement lens. The new lens have concentric ribs for improved light distribution.

③ To order replacement lens for push to test / illuminated pushbuttons starting with 52PA, 52PE, or 52PX, change the 6th digit to a P.

Selection and ordering data











Version	Suitable for	Color	Order no.
Mushroom head push pull illuminated plastic screw-on type	For small 1 3/4" type, push-pull units	red green amber	52RC3JR 52RC3JS 52RC3JT
	For large 2 1/2" type, push-pull units	red green amber	52RC3KR 52RC3KS 52RC3KT
 Mushroom head push pull illuminated metal screw-on type	Chrome, for small 1 3/4" type, push-pull units	red green amber white	52RB3H2 52RB3H3 52RB3H9 52RB3HB
	BlackMax, for small 1 3/4" type, push-pull units	red green amber white	52RX3H2 52RX3H3 52RX3H9 52RX3HB
 Mushroom head push pull non-illuminated plastic screw-on type	For small 1 3/4" type, push-pull units (catalog numbers starting with 52PP, 52BP, 52PM9 or 52BM9)①	black red green yellow blue gray orange 1 of each color	52RC3D1 52RC3D2 52RC3D3 52RC3D4 52RC3D5 52RC3D6 52RC3D8 52RC3DN
	For large 2 1/2" type, push-pull units (catalog numbers starting with 52PP, 52BP, 52PM9 or 52BM9)①	black red green yellow blue gray orange 1 of each color	52RC3E1 52RC3E2 52RC3E3 52RC3E4 52RC3E5 52RC3E6 52RC3E8 52RC3EN
 Mushroom head push pull non-illuminated metal screw-on type	For small 1 3/4" type, push-pull units (catalog numbers starting with 52PP or 52BP)①	red green chrome	52RC3F2 52RC3F3 52RC3FC
 Twist to release head illuminated plastic screw-on type	For small twist to release units	red green amber	52RC3RR 52RC3RS 52RC3RT
 Twist to release head non-illuminated plastic screw-on type	For small twist to release units	red green yellow	52RC3R2 52RC3R3 52RC3R4
 Replacement lens kit for illuminated selector switches (Knob with Insert)		red green blue amber clear white	52RA6P2 52RA6P3 52RA6P5 52RA6P9 52RA6PA 52RA6PB
 Lever inserts Short lever Long lever		red green yellow blue gray orange white red green yellow blue gray orange white	52RA2A2 52RA2A3 52RA2A4 52RA2A5 52RA2A6 52RA2A8 52RA2AB 52RA2B2 52RA2B3 52RA2B4 52RA2B5 52RA2B6 52RA2B8 52RA2BB

① For push-pull units whose catalog numbers that start with 52PX, 52PA or 52PE, replacement heads are available. Order from the 52RB type "Mushroom head pushbutton cap" section on page 10/216.

30mm Water, Oil Tight & Corrosion Resistant – Class 52

Accessories and spare parts

Selection and ordering data

Version	Suitable for	Color	Order no.
 Protective boot Offers protection from ice and foreign substances from interfering with button operation	Flush pushbutton operations	clear black	52AABA 52AAB1
 Guards Prevents accidental operation	Non-illuminated basic pushbuttons 1 5/8" mushroom pushbuttons, 1 3/4" push-pull units ^① , and twist to release units Push to test/illuminated pushbutton and indicator lights	chrome blackmax chrome blackmax chrome blackmax	52AAGP 52AXGP 52AAGM 52AXGM 52AAGL 52AXGL
 EMERGENCY-STOP Backing Ring	Yellow 90mm E-STOP Backing Ring		52AAR
 Locknuts Replacement front ring	Non-illuminated basic pushbuttons Non-illuminated mushroom pushbuttons Push-pull and twist-to-release units (only for push-pull units starting with 52PP or 52BP) ^② Indicator Lights Selector switches	chrome blackmax chrome blackmax chrome blackmax blue amber chrome blackmax	52AANP 52AXNP 52AANL 52AXNL 52CANP 52CXNP 52AANL 52AXNL 52AANS 52AXNS
Mounting Accessories	Class 52 Trim Washer Kit (Set of 10 pcs) Class 52 Washer Kit (Include 2-Neoprene Gaskets, 1-Trim Washer, 1-Index Locking Ring (chrome))	chrome	52AAQ 52AAD
Padlock attachments	Non-illuminated basic pushbuttons	flush extended	52AALA 52AALB
 EMERGENCY-STOP Lock Out	Class 52 Illuminated Mushroom Head Pushbuttons; 304 Stainless Steel	chrome (304 SS)	52AALE
 Padlock cover Lock devices in off position	Pushbuttons, selector switches, and non-illuminated mushroom heads		52AALS
 Lock nut wrench	All devices		52MAWB
 Hole plugs		corrosion resistant steel, grey stainless steel	52AAH6 52ABH6 52ABHS
Spare keys (Kit includes 1 Key)	Class 52 Standard Keyed Selector Switch. Keyed Selector Switch ordered with Suffix X302. Keyed Selector Switch ordered with Suffix X301. Keyed Selector Switch ordered with Suffix X300. Keyed Selector Switch ordered with Suffix X299. Keyed Selector Switch ordered with Suffix X298.	501CH 506CH 547CH 548CH 549CH 550CH	52KEY-501CH 52KEY-506CH 52KEY-547CH 52KEY-548CH 52KEY-549CH 52KEY-550CH
 Grounding kit	All devices		52AL109145
 Touchsafe contact blocks with gold flashing			
52 BAJ	1 NO 1 NC 1 NO - 1 NC		52BAK 52BAJ ^③ 52BJK ^④
52 BAK	1 NO early make 1 NC late break 1 NO - 1 NC	closes before 52BAK opens after 52 BAJ Reed switch; UL listed for class 1 division 2; .25A Max, 200V AC, 10 Watt max .5A Max, 200V DC, 10 Watt max	52BAH 52BAE 52BAR ^③
52 BAR	1 NC extra late break		52BAU

① These can also be used with the 1 5/8" push-pull devices.

② For push-pull units starting with part numbers 52PA, 52PE or 52PX, replacement locknuts can be ordered using 52AANL (Chrome) and 52AXNL (BlackMax).

③ Hermetically Sealed

④ ⊕ Positive opening according to IEC 60947-5-1, Appendix K.

Selection and ordering data

Version	Suitable for	Lamp voltage	Color	Order no.
Lamps with screw connection, miniature bayonet (BA 9s style)				
Incandescent lamps,				
	Flashing, type 267 lamp (replaces 755 lamp)	51, 52	6 V	52AABNF
	6V type 755 lamp (Rated 150 mA)	51, 52	6 V	52AABN
	12V type 756 (Rated 80 mA)	51, 52	12 V	52AACN
	24V type 757 (Rated 80 mA)	51, 52	24 V	52AADN
	48V, 2W	52	48 V	3SB1902-1AP
	60V, 2W	52	60 V	3SR9424
	120V, 2.5W, type #120MB (Rated 250 mA)	52	120 V	52AAENC1
Neon (uses resistors) type B2A (NE-51H)	52	120 V	52AAPN	
Candelabra, 120V, 3W, Full voltage type 3S6/5	52 older revision styles	120 V		52AAENC
LED bulbs^①				
LED, BA9s type ^②	Class 52	6 V AC/DC 24 V AC/DC 120 V AC/DC		52AEB□ 52AED□ 52AEE□
Super-Bright LED ^②	Class 52	6 V AC/DC 24 V AC/DC 120 V AC/DC 120 V DC		52AEB□7 52AED□7 52AEE□7 52AEV□7
LED lighting module with integrated LED.				
Single LED (Rated 35 mA Maximum)	Class 52	24 V AC/DC 120 V AC 240 V AC		52AAIL□ 52AAIM□ 52AAIN□
Full voltage lighting module accessory with BA9s type lamp^①				
LED ^②	Class 52	6 V AC/DC 24 V AC/DC 120 V AC/DC		52AAF□B 52AAF□D 52AAF□E
Super-Bright LED ^②	Class 52	6 V AC/DC 24 V AC/DC 120 V AC/DC		52AAF□Y 52AAF□D Y 52AAF□E Y
Incandescent bulb	Class 52	6 V AC/DC 24 V AC/DC 120 V AC/DC		52AAF□B 52AAF□D 52AAF□E
Transformer lighting module accessory with BA9s type lamp^①				
LED	Class 52	120 V AC 240 V AC 480 V AC 600 V AC		52AAT□B 52AATH□B 52AAT□J 52AAT□K
Super-Bright LED	Class 52	120 V AC 240 V AC 480 V AC 600 V AC		52AAT□Y 52AATH□Y 52AAT□J Y 52AAT□K Y
Incandescent bulb	Class 52	120 V AC 240 V AC 480 V AC 600 V AC		52AAT□N 52AATH□N 52AAT□J N 52AAT□K N

Color options:

red
green
yellow/amber
blue
white/clear

2
3
4
5
B

① Standard LED lamps are recommended for indoor applications, Super-Bright LED Lamps are recommended for outdoor applications.

② 6V, 24V (Super Bright only) and 120V are currently AC only. Replaced by AC/DC rated versions end of 2014.

30mm Water, Oil Tight & Corrosion Resistant – Class 52

Dimensional drawings

Non-Illuminated Push-Pull
Metal Mushroom Head

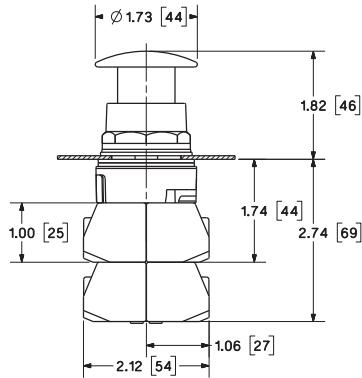

Non-Illuminated Push-Pull
Small Plastic Mushroom Head

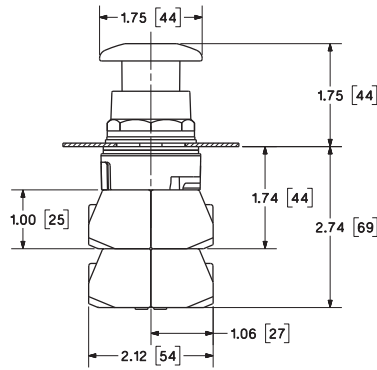

Non-Illuminated Push-Pull
Large Plastic Mushroom Head

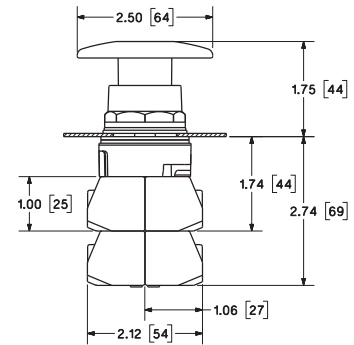

Illuminated Push-Pull
Metal Mushroom Head

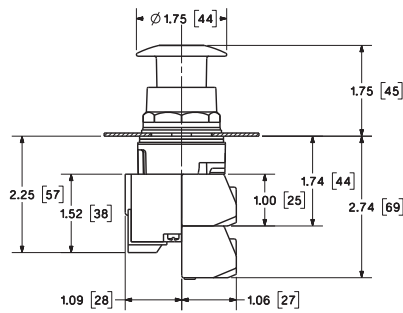

Fully Illuminated Push-Pull
Small Plastic Mushroom Head

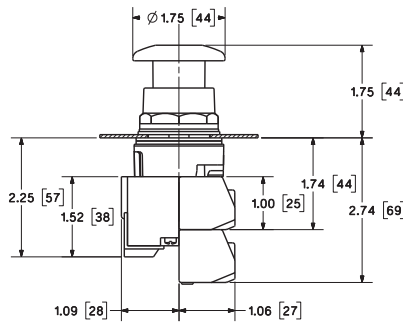

Illuminated Push-Pull
Large Plastic Mushroom Head

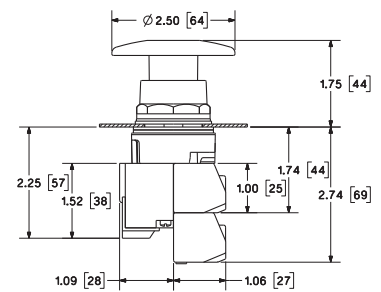

Non-Illuminated Twist Release
Plastic Mushroom Head

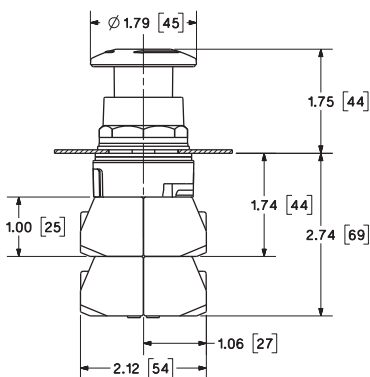

Illuminated Twist Release
Plastic Mushroom Head

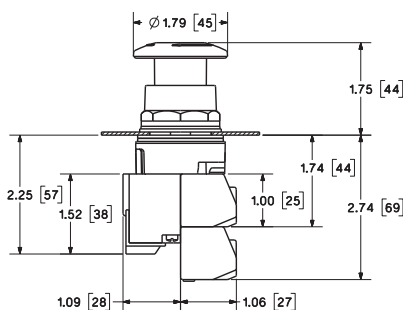

Illuminated Pushbutton Flush Lens
Illuminated Pushbutton Extended Lens
Illuminated Push to Test

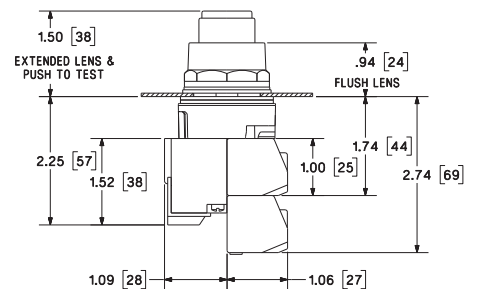

30mm Water, Oil Tight & Corrosion Resistant – Class 52

Dimensional drawings

Selector Switch
Non-Illuminated

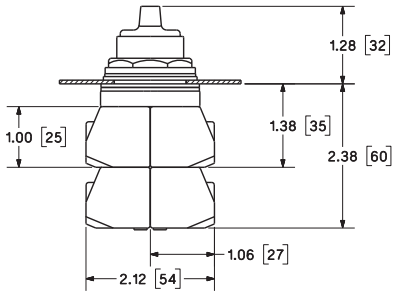

Selector Switch
Illuminated

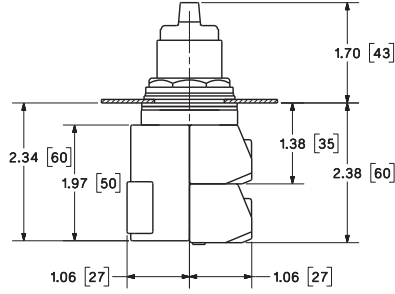

Indicator Light
Plastic Lens

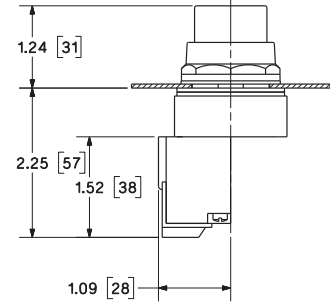

Momentary Pushbutton
Non-Illuminated Flush Cap

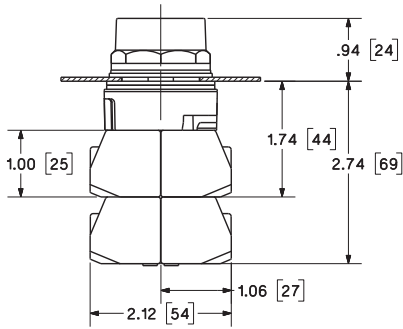

Momentary Pushbutton
Non-Illuminated Raised Cap

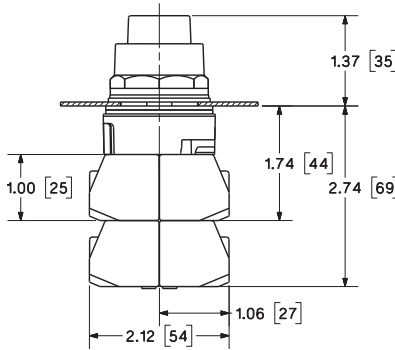

Indicator Light
Glass Lens

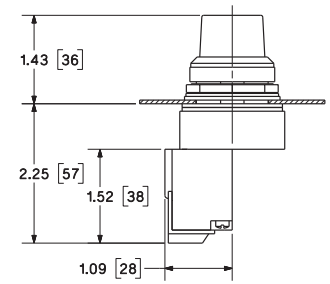

Momentary Pushbutton
Metal Mushroom Head

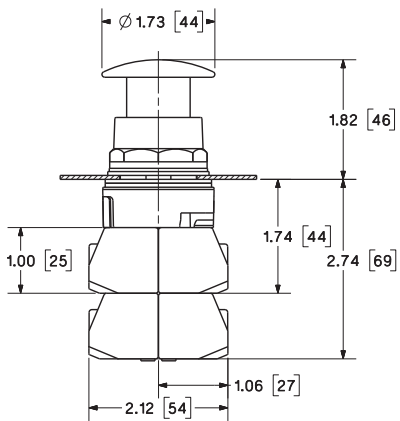

Momentary Pushbutton
Small Plastic Mushroom Head

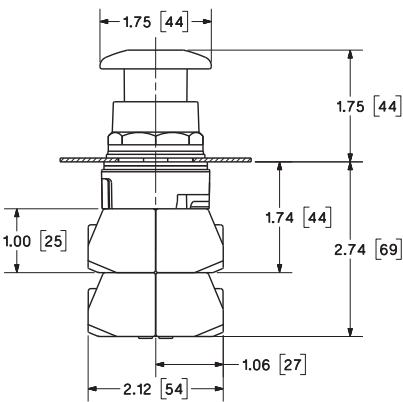

Momentary Pushbutton
Large Plastic Mushroom Head

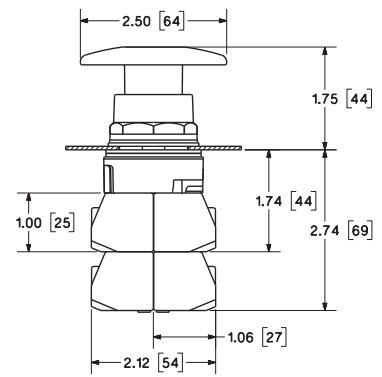

30mm Water, Oil Tight & Corrosion Resistant – Class 52

Dimensional drawings

Illuminated Momentary Pushbutton
Metal Mushroom Head

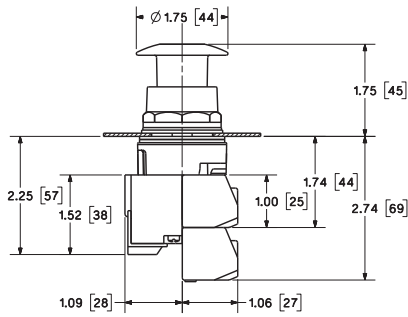

Illuminated Momentary Pushbutton
Small Plastic Mushroom Head

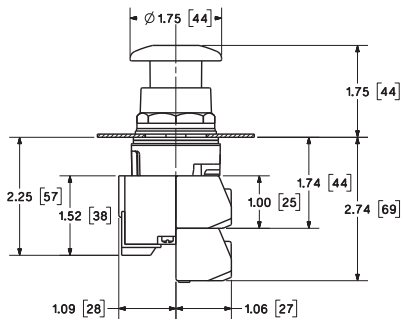

Illuminated Momentary Pushbutton
Large Plastic Mushroom Head

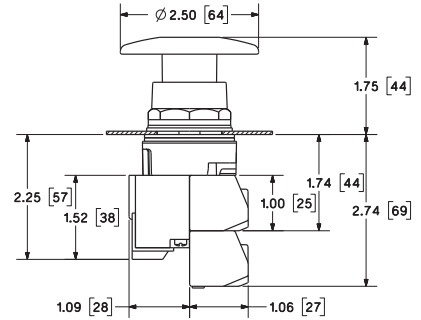

Selector Switch
Keyed

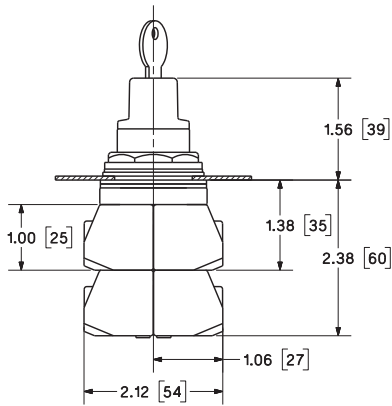

Wobble Switch

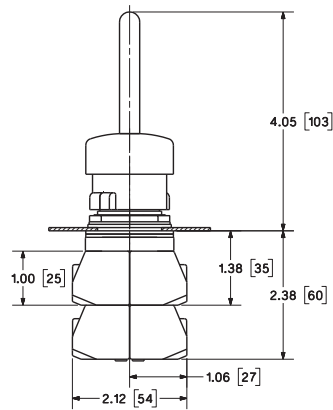

Potentiometer Switch

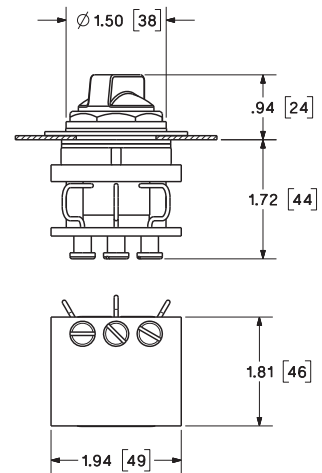

Toggle Switch

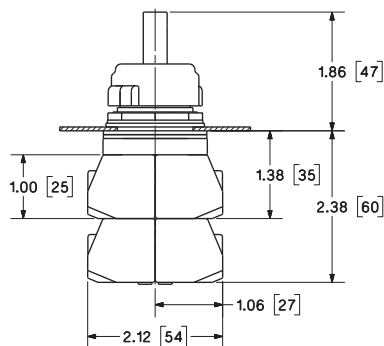

Selector Pushbutton Switch
Flush Cap

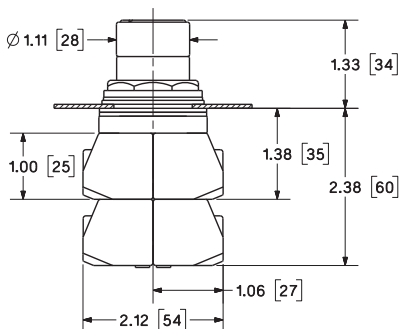

Selector Pushbutton Switch
Raised Cap

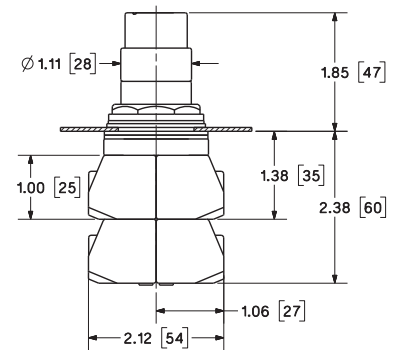

Dimensional drawings

Momentary Pushbutton Guard
Illuminated Push to Test Guard

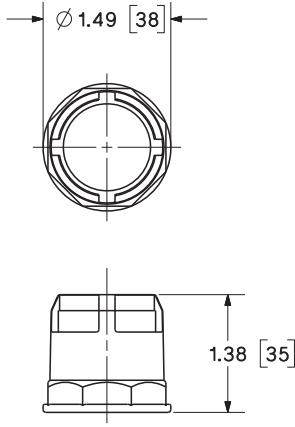

Mushroom Head Guard

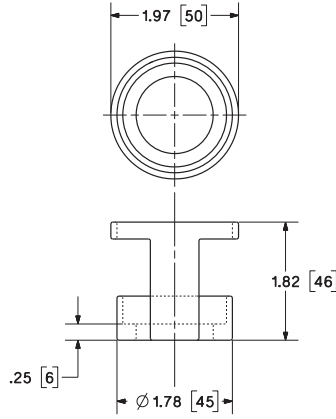

Contact Block

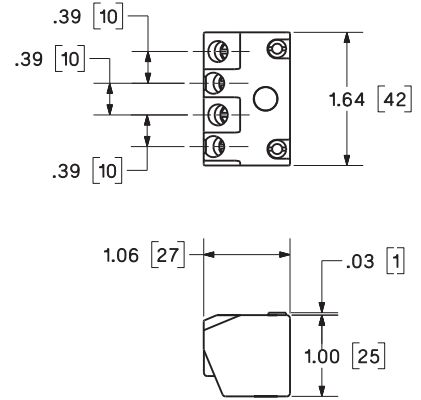

Large Metal Legend Plate

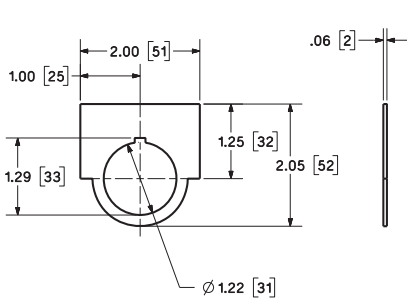

Automotive Metal Legend Plate

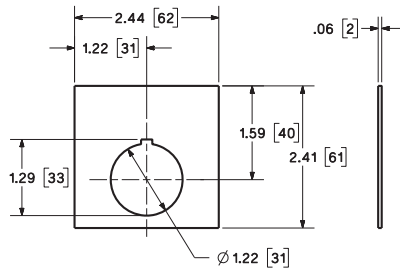

Large Plastic Legend Plate

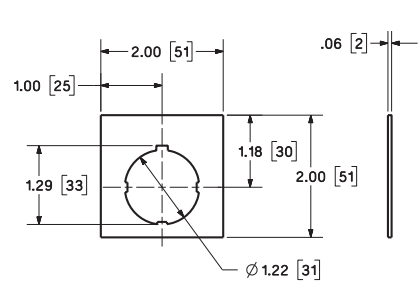

30mm Water, Oil Tight & Corrosion Resistant - Class 52

Class 52 oiltight pushbutton stations

Selection and ordering data

	Actuator identification C = top device in station B = middle device in station A = bottom device in station	Degree of protection ^①	Contact / voltage	No. of command points	Order no.	Pack Unit
1 unit control station	A = Momentary flush pushbutton black, label "START"	NEMA 12	1NO - 1NC	1	52C101A	
	A = Momentary raised pushbutton red, label "STOP"	NEMA 12	1NO - 1NC	1	52C103A	
	A = Momentary mushroom head red, label "STOP"	NEMA 12	1NO - 1NC	1	52C104A	
	A = Maintained metal mushroom head red, label "EMERGENCY STOP"	NEMA 12	1NO - 1NC	1	52C117A	
	A = 2 position selector switch "OFF-ON"	NEMA 12	1NO - 1NC	1	52C159A	
	A = 3 position selector switch "HAND-OFF-AUTO"	NEMA 12	1NO - 1NC	1	52C156A	
	A = Indicator light, red	NEMA 12	120V Transformer type	1	52C131A	
	A = Indicator light, green	NEMA 12	120V Transformer type	1	52C135A	
	A = Momentary flush pushbutton black, label "START"	NEMA 4X Stainless Steel	1NO - 1NC	1	52C101S	
	A = Momentary raised pushbutton red, label "STOP"	NEMA 4X Stainless Steel	1NO - 1NC	1	52C103S	
	A = Momentary mushroom head red, label "STOP"	NEMA 4X Stainless Steel	1NO - 1NC	1	52C104S	
	A = Maintained plastic mushroom head red, label "EMERGENCY STOP"	NEMA 4X Stainless Steel	1NO - 1NC	1	52C116S	
	A = 2 position selector switch "OFF-ON"	NEMA 4X Stainless Steel	1NO - 1NC	1	52C159S	
	A = 3 position selector switch "HAND-OFF-AUTO"	NEMA 4X Stainless Steel	1NO - 1NC	1	52C156S	
	A = Momentary flush pushbutton black, label "START"	NEMA 4X Fiberglass	1NO - 1NC	1	52C101X	
	A = Momentary raised pushbutton red, label "STOP"	NEMA 4X Fiberglass	1NO - 1NC	1	52C103X	
	A = Momentary mushroom head red, label "STOP"	NEMA 4X Fiberglass	1NO - 1NC	1	52C104X	
	A = Maintained plastic mushroom head red, label "EMERGENCY STOP"	NEMA 4X Fiberglass	1NO - 1NC	1	52C116X	
	A = 2 position selector switch "OFF-ON"	NEMA 4X Fiberglass	1NO - 1NC	1	52C159X	
	A = 3 position selector switch "HAND-OFF-AUTO"	NEMA 4X Fiberglass	1NO - 1NC	1	52C156X	
2 unit control station	B = Momentary flush pushbutton black, label "START" A = Momentary raised pushbutton red, label "STOP"	NEMA 12	1NO, 1NC 1NO, 1NC	2	52C201A	
	B = Momentary flush pushbutton black, label "START" A = Momentary Mushroom head pushbutton red, label "STOP"	NEMA 12	1NO, 1NC 1NO, 1NC	2	52C202A	
	B = Momentary flush pushbutton, label "FORWARD" A = Momentary flush pushbutton, label "REVERSE"	NEMA 12	1NO, 1NC 1NO, 1NC	2	52C204A	
	B = Momentary flush pushbutton, label "UP" A = Momentary flush pushbutton, label "DOWN"	NEMA 12	1NO, 1NC 1NO, 1NC	2	52C223A	
	B = Indicator light, red, label "RUN" A = Maintained selector switch, label "HAND-OFF-AUTO"	NEMA 12	120V Transformer type	2	52C224A	
	B = Indicator light, red A = Indicator light, green	NEMA 12	120V Transformer type	2	52C230A	
	B = Momentary flush pushbutton black, label "START" A = Momentary raised pushbutton red, label "STOP"	NEMA 4X Stainless Steel	1NO, 1NC 1NO, 1NC	2	52C201S	
	B = Momentary flush pushbutton black, label "START" A = Momentary Mushroom head pushbutton red, label "STOP"	NEMA 4X Stainless Steel	1NO, 1NC 1NO, 1NC	2	52C202S	
	B = Momentary flush pushbutton, label "UP" A = Momentary flush pushbutton, label "DOWN"	NEMA 4X Stainless Steel	1NO, 1NC 1NO, 1NC	2	52C223S	
	B = Indicator light, red, label "RUN" A = Maintained selector switch, label "HAND-OFF-AUTO"	NEMA 4X Stainless Steel	120V Transformer type 1NO, 1NC	2	52C224S	
	B = Momentary flush pushbutton black, label "START" A = Momentary raised pushbutton red, label "STOP"	NEMA 4X Fiberglass	1NO, 1NC 1NO, 1NC	2	52C201X	
	B = Momentary flush pushbutton black, label "START" A = Momentary Mushroom head pushbutton red, label "STOP"	NEMA 4X Fiberglass	1NO, 1NC 1NO, 1NC	2	52C202X	
	B = Momentary flush pushbutton, label "UP" A = Momentary flush pushbutton, label "DOWN"	NEMA 4X Fiberglass	1NO, 1NC 1NO, 1NC	2	52C223X	
	B = Indicator light, red, label "RUN" A = Maintained selector switch, label "HAND-OFF-AUTO"	NEMA 4X Fiberglass	120V Transformer type 1NO, 1NC	2	52C224X	



① NEMA 4X Stainless Steel Enclosure is 304 SS.

Selection and ordering data

Actuator identification	Degree of protection ^①	Contact / voltage	No. of command points	Order no.	Pack	
3 unit control station 	C = Indicator light, red	NEMA 12	120V 1NO, 1NC	3	52C307A	Unit
	B = Momentary flush pushbutton black, label "START" A = Momentary raised pushbutton red, label "STOP"		1NO, 1NC 1NO, 1NC			
	C = Momentary flush pushbutton black, label "FORWARD" B = Momentary flush pushbutton black, label "REVERSE" A = Momentary raised pushbutton red, label "STOP"	NEMA 12	1NO, 1NC 1NO, 1NC 1NO, 1NC	3	52C301A	
C = Momentary flush pushbutton black, label "UP" B = Momentary flush pushbutton black, label "DOWN" A = Momentary raised pushbutton red, label "STOP"	NEMA 12	1NO, 1NC 1NO, 1NC 1NO, 1NC	3	52C332A		
C = Momentary flush pushbutton black, label "OPEN" B = Momentary flush pushbutton black, label "CLOSE" A = Momentary raised pushbutton red, label "STOP"	NEMA 12	1NO, 1NC 1NO, 1NC 1NO, 1NC	3	52C333A		
C = Momentary flush pushbutton black, label "HI" B = Momentary flush pushbutton, black label "LOW" A = Momentary raised pushbutton red, label "STOP"	NEMA 12	1NO, 1NC 1NO, 1NC 1NO, 1NC	3	52C334A		
C = Indicator light, red	NEMA 4X Stainless Steel	120V 1NO, 1NC	3	52C307S		
B = Momentary flush pushbutton black, label "START" A = Momentary raised pushbutton red, label "STOP"		1NO, 1NC 1NO, 1NC				
C = Momentary flush pushbutton black, label "FORWARD" B = Momentary flush pushbutton black, label "REVERSE" A = Momentary raised pushbutton red, label "STOP"	NEMA 4X Stainless Steel	1NO, 1NC 1NO, 1NC 1NO, 1NC	3	52C301S		
C = Momentary flush pushbutton black, label "UP" B = Momentary flush pushbutton black, label "DOWN" A = Momentary raised pushbutton red, label "STOP"	NEMA 4X Stainless Steel	1NO, 1NC 1NO, 1NC 1NO, 1NC	3	52C332S		
C = Momentary flush pushbutton black, label "OPEN" B = Momentary flush pushbutton black, label "CLOSE" A = Momentary raised pushbutton red, label "STOP"	NEMA 4X Stainless Steel	1NO, 1NC 1NO, 1NC 1NO, 1NC	3	52C333S		
C = Momentary flush pushbutton black, label "HI" B = Momentary flush pushbutton, black label "LOW" A = Momentary raised pushbutton red, label "STOP"	NEMA 4X Stainless Steel	1NO, 1NC 1NO, 1NC 1NO, 1NC	3	52C334S		
C = Indicator light, red	NEMA 4X Fiberglass	120V 1NO, 1NC	3	52C307X		
B = Momentary flush pushbutton black, label "START" A = Momentary raised pushbutton red, label "STOP"		1NO, 1NC 1NO, 1NC				
C = Momentary flush pushbutton black, label "FORWARD" B = Momentary flush pushbutton black, label "REVERSE" A = Momentary raised pushbutton red, label "STOP"	NEMA 4X Fiberglass	1NO, 1NC 1NO, 1NC 1NO, 1NC	3	52C301X		
C = Momentary flush pushbutton black, label "UP" B = Momentary flush pushbutton black, label "DOWN" A = Momentary raised pushbutton red, label "STOP"	NEMA 4X Fiberglass	1NO, 1NC 1NO, 1NC 1NO, 1NC	3	52C332X		
C = Momentary flush pushbutton black, label "OPEN" B = Momentary flush pushbutton black, label "CLOSE" A = Momentary raised pushbutton red, label "STOP"	NEMA 4X Fiberglass	1NO, 1NC 1NO, 1NC 1NO, 1NC	3	52C333X		
C = Momentary flush pushbutton black, label "HI" B = Momentary flush pushbutton, black label "LOW" A = Momentary raised pushbutton red, label "STOP"	NEMA 4X Fiberglass	1NO, 1NC 1NO, 1NC 1NO, 1NC	3	52C334X		

① NEMA 4X Stainless Steel Enclosure is 304 SS.

30mm Water, Oil Tight & Corrosion Resistant - Class 52

Empty enclosures

Selection and ordering data



Version	Number of command points	Degree of protection	Order No.①	Pack Unit
Standard enclosures come with 2 1/4" leg center for legend spacing. Automotive end plates require 2 1/2" spacing. For more than 2 contact blocks on the right or left, use extra deep enclosure.	1	NEMA Type 12/13	P30EMS01	
	1	NEMA Type 12/13 extra deep	P30EMS01D	
	1	NEMA Type 4/4X stainless steel	P30EMS014	
	1	NEMA Type 4/4X Fiberglass	P30EMS01X	
Mounting hole arrangement 1 thru 4 are in one row 6 holes are 3 down and 2 across 9 holes are 3 down and 3 across 12 holes are 4 down and 3 across 16 holes are 4 down and 4 across	2	NEMA Type 12/13	P30EMS02	
	2	NEMA Type 12/13 extra deep	P30EMS02D	
	2	NEMA Type 4/4X stainless steel	P30EMS024	
	2	NEMA Type 4/4X Fiberglass	P30EMS02X	
	3	NEMA Type 12/13	P30EMS03	
	3	NEMA Type 12/13 extra deep	P30EMS03D	
	3	NEMA Type 4/4X stainless steel	P30EMS034	
	3	NEMA Type 4/4X Fiberglass	P30EMS03X	
	4	NEMA Type 12/13	P30EMS04	
	4	NEMA Type 12/13 extra deep	P30EMS04D	
	4	NEMA Type 4/4X stainless steel	P30EMS044	
	4	NEMA Type 4/4X Fiberglass	P30EMS04X	
	6	NEMA Type 12/13	P30EMS06	
	6	NEMA Type 12/13 extra deep	P30EMS06D	
	6	NEMA Type 4/4X stainless steel	P30EMS064	
	9	NEMA Type 12/13	P30EMS09	
9	NEMA Type 12/13 extra deep	P30EMS09D		
9	NEMA Type 4/4X stainless steel	P30EMS094		
12	NEMA Type 12/13	P30EMS12		
12	NEMA Type 12/13 extra deep	P30EMS12D		
12	NEMA Type 4/4X stainless steel	P30EMS124		
16	NEMA Type 12/13	P30EMS16		
16	NEMA Type 12/13 extra deep	P30EMS16D		
16	NEMA Type 4/4X stainless steel	P30EMS164		

Order Form

Ordering Information	
<p>Enclosure Hole Arrangement</p>	<p>To order non-standard control stations select catalog numbers from the previous pages, determine the required position in the enclosure and fill in the table below. If a special legend plate is required, specify description in the table. The combined list prices of the components is the list price of the station.</p> <ul style="list-style-type: none"> Select enclosure Vertical or Horizontal. Outline Diagram at left starting at the top left-hand corner. Example: 3 unit vertical outline location No. 1A, 2A and 3A. 3 unit horizontal outline location No. 1A, 1B, and 1C List location No. and applicable catalog numbers in the table below. Use complete catalog numbers where possible
<p>Order No./Item No. _____</p> <p>Customer _____</p> <p>Enclosure Catalog No. _____</p>	

Location	Operator PB-SEL.-PL	Accessories Key Lock, Boot, Etc,	Legend Plate Legend or Blank	Special Marking

① NEMA 4X Stainless Steel Enclosure is 304 SS.

30 mm Heavy Duty, Watertight/Oiltight, Class 52

Legend plates for Class 51 and 52

Design

The 30 mm legend plates are approved for the use with both Class 51 and Class 52 devices. Automotive legend plates require 2 1/2" mounting centers. Plastic legend plates will have white letters engraved.

When ordering custom engraved legend plates, specify the required inscription text.

Selection and ordering data

Inscription	Large (1 1/4" x 2")	Automotive ^① (2 7/16" x 2 7/16")	Large Plastic ^② (2 1/16" x 2")	Automotive Plastic ^{②②} (2 7/16" x 2 7/16")
	Order No.	Order No.	Order No.	Order No.
"Blank (brushed aluminum)"	52NL02	52NA02	—	—
"Blank (red)"	52NL02R	52NA02R	52ND02R	52NE02R
"Blank (Black)"	52NL02B	52NA02B	52ND02B	52NE02B
Inscribed legend plates with large brushed aluminum background				
Close	52NL18	52NA18	—	—
Down	52NL10	52NA10	—	—
Emerg Stop	52NL16	52NA16	—	—
Emerg Stop (red)	52NL16R	52NA16R	—	—
Fast-Slow	52NL33	52NA33	—	—
Forward	52NL05	52NA05	—	—
For-Off-Rev	52NL38	52NA38	—	—
For-Rev	52NL31	52NA31	—	—
Hand-Off-Auto	52NL37	52NA37	—	—
High	52NL07	52NA07	—	—
High-Low	52NL30	52NA30	—	—
High-Off-Low	52NL44	52NA44	—	—
In	52NL21	52NA21	—	—
Jog	52NL13	52NA13	—	—
Jog-Forward	52NL24	52NA24	—	—
Jog-Reverse	52NL25	52NA25	—	—
Low	52NL08	52NA08	—	—
Lower	52NL20	52NA20	—	—
Man-Auto	52NL35	52NA35	—	—
Off	52NL12	52NA12	—	—
Off-On	52NL26	52NA26	—	—
On	52NL11	52NA11	—	—
On-Off-Auto	52NL40	52NA40	—	—
Open	52NL17	52NA17	—	—
Open-Close	52NL34	52NA34	—	—
Open-Off-Close	52NL41	52NA41	—	—
Out	52NL22	52NA22	—	—
Pull to Start Push to Stop	52NL47	52NA47	—	—
Raise	52NL19	52NA19	—	—
Raise-Lower	52NL36	52NA36	—	—
Reset	52NL14	52NA14	—	—
Reverse	52NL06	52NA06	—	—
Run	52NL23	52NA23	—	—
Run-Jog	52NL29	52NA29	—	—
Safe-Run	52NL27	52NA27	—	—
Slow-Off-Fast	52NL39	52NA39	—	—
Start	52NL03	52NA03	—	—
Start-Jog	52NL28	52NA28	—	—
Start-Stop	52NL32	52NA32	—	—
Stop	52NL04	52NA04	—	—
Stop (red)	52NL04R	52NA04R	—	—
Up	52NL09	52NA09	—	—
Up-Down	52NL49	52NA49	—	—
Up-Off-Down	52NL42	52NA42	—	—
Inscription plates with custom engraving				
"Custom engraved (brushed aluminum)"	52NL02E	52NA02E	—	—
"Custom engraved (red)"	52NL02RE	52NA02RE	52ND02RE	52NE02RE
"Custom engraved (Black)"	52NL02BE	52NA02BE	52ND02BE	52NE02BE
Max. number of rows	2	2	2	2
Letter height	5/32"	1/4"	5/32"	1/4"
Characters per row	14	16	14	16

① Automotive requires 2 1/2" mounting centers
 ② White letters on plastic nameplate.

30mm Heavy Duty, Watertight/Oiltight, Class 52

Dimensional drawings

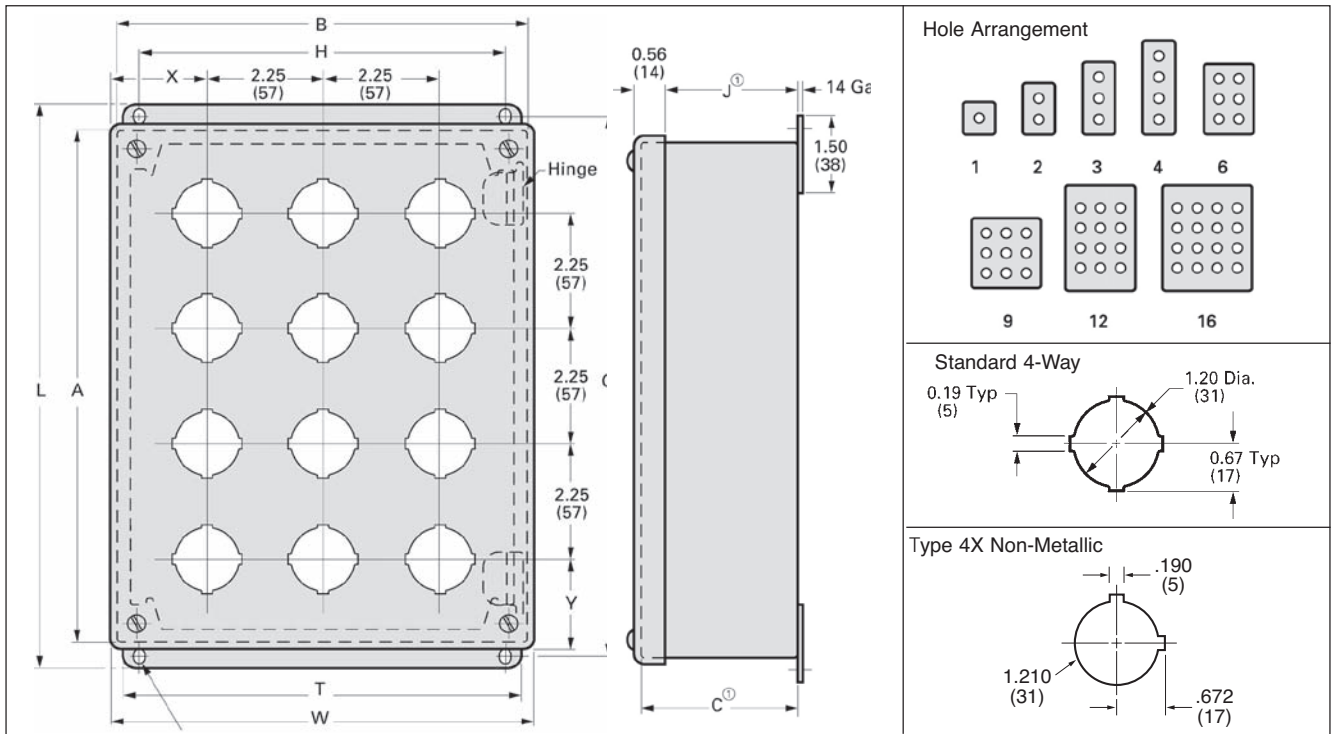

Type 12/13 and 4X Stainless Steel

Units	Enclosure Size			Mounting		Overall					
	A	B	C	G	H	L	W	J	T	X	Y
1	3.50 (89)	3.25 (83)	2.75 (70)	4.00 (102)	2.38 (60)	4.50 (114)	3.47 (88)	2.31 (59)	3.00 (76)	1.73 (44)	1.86 (47)
2	5.75 (146)	3.25 (83)	2.75 (70)	6.25 (159)	2.38 (60)	6.75 (171)	3.47 (88)	2.31 (59)	3.00 (76)	1.73 (44)	1.86 (47)
3	8.00 (203)	3.25 (83)	2.75 (70)	8.50 (216)	2.38 (60)	9.00 (229)	3.47 (88)	2.31 (59)	3.00 (76)	1.73 (44)	1.86 (47)
4	10.25 (260)	3.25 (83)	2.75 (70)	10.75 (273)	2.38 (60)	11.25 (286)	3.47 (88)	2.31 (59)	3.00 (76)	1.73 (44)	1.86 (47)
6	9.50 (241)	6.25 (159)	3.00 (76)	10.00 (254)	5.38 (137)	10.50 (267)	6.47 (164)	2.56 (65)	6.00 (152)	2.11 (54)	2.61 (66)
9	9.50 (241)	8.50 (216)	3.00 (76)	10.00 (254)	7.62 (194)	10.50 (267)	8.72 (221)	2.56 (65)	8.25 (210)	2.11 (54)	2.61 (66)
12	11.75 (298)	8.50 (216)	3.00 (76)	12.25 (311)	7.62 (194)	12.75 (324)	8.72 (221)	2.56 (65)	8.25 (210)	2.11 (54)	2.61 (66)
16 ²⁾	11.75 (298)	10.75 (273)	3.00 (76)	12.25 (311)	9.88 (251)	12.75 (324)	10.97 (279)	2.56 (65) ²⁾	10.50 (267)	2.11 (54)	2.61 (66)

Type 12/13 Extra Deep Enclosures

Units	Enclosure Size			Mounting		Overall					
	A	B	C	G	H	L	W	J	T	X	Y
1	4.00	4.00	4.75	4.50	3.12	5.00	4.22	4.31	3.75	2.11	2.11
2	6.00	4.00	4.75	6.50	3.12	7.00	4.22	4.31	3.75	2.11	1.98
3	8.00	4.00	4.75	8.50	3.12	9.00	4.22	4.31	3.75	2.11	1.86
4	10.00	4.00	4.75	10.50	3.12	11.00	4.22	4.31	3.75	2.11	1.73
6	9.50	6.25	4.75	10.00	5.38	10.50	6.47	4.31	6.00	2.11	2.61
9	9.50	8.50	4.75	10.00	7.62	10.50	8.72	4.31	8.25	2.11	2.61
12	11.75	8.50	4.75	12.25	7.62	12.75	8.72	4.31	8.25	2.11	2.61
16 ²⁾	11.75	10.75	4.75	12.25	9.88	12.75	10.97	4.31	10.50	2.11	2.61

Type 4X Non-Metallic

Units	Enclosure Size		Mounting		Overall	
	A	B	C	G	H	W
1	6.00	3.19	3.63	4.88	2.94	3.81
2	6.00	3.19	3.63	4.88	2.94	3.81
3	8.26	3.19	3.63	7.13	2.94	3.81
4	10.51	3.19	3.63	9.37	2.94	3.81

All dimensions shown in inches and (millimeters). For reference purposes only. Not to be used for design or construction purposes.

- 1) Grounding stud in body of enclosure.
- 2) For stainless steel add 1.75 (45) to depth.

30 mm Pilot Devices

Technical Specifications

Standards	UL Listed File # E22655	CSA Certified File # LR6535
Utilization	Category NEMA	A600/P600
Degree of Protection	52B, 52P-, 52S-, 52M- Operators	NEMA: 1, 3, 3R, 4, 4X, 12 and 13 IEC 529; IP10, IP11, IP14, IP52, IP54, IP56 and IP66

Rated Operational Current

NEMA A600 – 10 Continuous Amps			NEMA P600 – Rating Codes for DC Control Circuit Application	
Voltage AC	Make Amps	Break Amps	Thermal Continuous Test Current Amps	
120V	60	6	Maximum Make or Break; Current / Amps	5.0
240V	30	3	125V	1.10
480V	15	1.5	250V	0.55
600V	12	1.2	301-600V	0.20
Total VA	7200	720	Maximum Make or Break Volt amperes at 300V or Less	138

Contact Blocks	52BAK, -BAJ [Ⓞ] , -BAH, -BAU, -BJK [Ⓞ] 52BAR	600VAC Maximum, Heavy Duty 200VAC .25 Amp, 10 Watt Maximum 200VDC .50 Amp, 10 Watt Maximum
-----------------------	---	--

[Ⓞ] Positively driven contacts. Contact blocks are suitable for applications down to 5V/1MA low voltage applications as found in PLCs. 52BAR are Class 1; Division 2 Compliant

Pilot Light	Full Voltage LED Module Transformer Type	52PL4/52PL5 or 52BL4/52BL5	-B (6-8V), -C (12V), -D (24V), -E (120V), -F (240V) -L (24V), -M (120V) -N (240V) -G (120V), -H (240V), -J (480V), -K (600V)	240V AC/DC Max. 240V AC Max. 600V AC Max., 50/60 Hz
Push-to-Test	Full Voltage LED Module Transformer Type	52PT6 or 52BT6	-B (6-8V), -C (12V), -D (24V), -E (120V), -F (240V) -L (24V), -M (120V), -N (240V) -G (120V), -H (240V), -J (480V), -K (600V)	240V AC/DC Max. 240V AC Max. 600VAC Max., 50/60 Hz
Illuminated Push-Pull	Full Voltage LED Module Transformer	52PP2(3,7) or 52BP2(3,7)	-B (6-8V), -C (12V), -D (24V), -E (120V), -F (240V) -L (24V), -M (120V), -N (240V) -G (120V), -H (240V), -J (480V), -K (600V)	240V AC/DC Max. 240V AC Max. 600VAC Max., 50/60 Hz
Twist-to-Release	Full Voltage LED Module Transformer	52BR8 or 52PR8	-B (6-8V), -C (12V), -D (24V), -E (120V), -F (240V) -L (24V), -M (120V), -N (240V) -G (120V), -H (240V), -J (480V), -K (600V)	240V AC/DC Max. 240V AC Max. 600VAC Max., 50/60 Hz
Illuminated Selector Switch	Full Voltage Transformer	52SA7(A,B,C) or 52SX7(A,B,C)	-B (6-8V), -C (12V), -D (24V), -E (120V), -F (240V) -G (120V), -H (240V), -J (480V), -K (600V)	240V AC/DC Max. 600V AC Max., 50/60 Hz

Dielectric Strength 2200V for one minute

Mechanical Design Life Cycles

Vibration	Frequency 5 - 60Hz.; Disp. .030 inches, sweep 5 minutes for a duration of 30 minutes on each axis. Not to exceed 5.5 G's for maximum of 1 minute.	
Pushbuttons	Momentary, Non-illuminated	5,000,000 Operating Cycles
	Momentary, Illuminated	300,000 Operating Cycles
Push-Pull	Maintained	300,000 Operating Cycles
	Momentary	2,000,000 Operating Cycles
Twist-to-Release		300,000 Operating Cycles
Selector Switches	Non-illuminated	2,000,000 Operating Cycles
	Illuminated, Key-operated	2,000,000 Operating Cycles
Contact Operation	Standard Contact Black Logic Reed	
Wire Gauge	#18-12 AWG	
Terminal Screw Torque	2-10 lb-in / 20 lb-in max; 8 lb-in recommended	
Locknut Torque	15 ft. lbs. max	
Temperature Range	Operating	31F to +158F (-35C to +70C)
	Storage	40F to +185F (-40C to +85C)

All parts are designed and manufactured of corrosion resistant material or are plated or painted as corrosion protection. All contact block contacts are gold flashed as a standard offering. Internal return spring mechanisms of operators and contact blocks of stainless steel. RoHS Compliant.

Declaration of Conformity — The products listed below, to which this declaration relates, are in conformity with the following standards, following the provisions of the Low Voltage Directive (LVD) (73/23/EEC), and the Electromagnetic Compatibility Directive (89/336/EEC.)

Products: Contact Blocks: Cat Nos. 52BAE, 52BAH, 52BAJ, 52BAK, 52BAR, 52BAU and 52BJK, with suffixes. Pilot Lights: Cat Nos 52P, with suffixes. Operators: Cat Nos 52S or 52P, with suffixes.

Applicable Standards: EN 60947-5-1 Low-Voltage Switchgear and controlgear. Enclosed devices meet the requirements of environmental ratings of IP10, IP11, IP14, IP52, IP54, and IP56. Open devices, when mounted as instructed, in environmental type IP10, IP11, IP14, IP52, IP54 or IP56 enclosures, maintain the environmental requirements for those enclosure types. Cat. No. 52BP, 52BR, 52PP, and 52PR, 2 Position, Twist-To-Release and 2 Position, Push Pull Maintained operators provided with red operating heads and 52BJK contact blocks meet the requirements of EN 60947-5-5 for Electrical Emergency Stop Device With Mechanical Latching Function (e-stop).

