

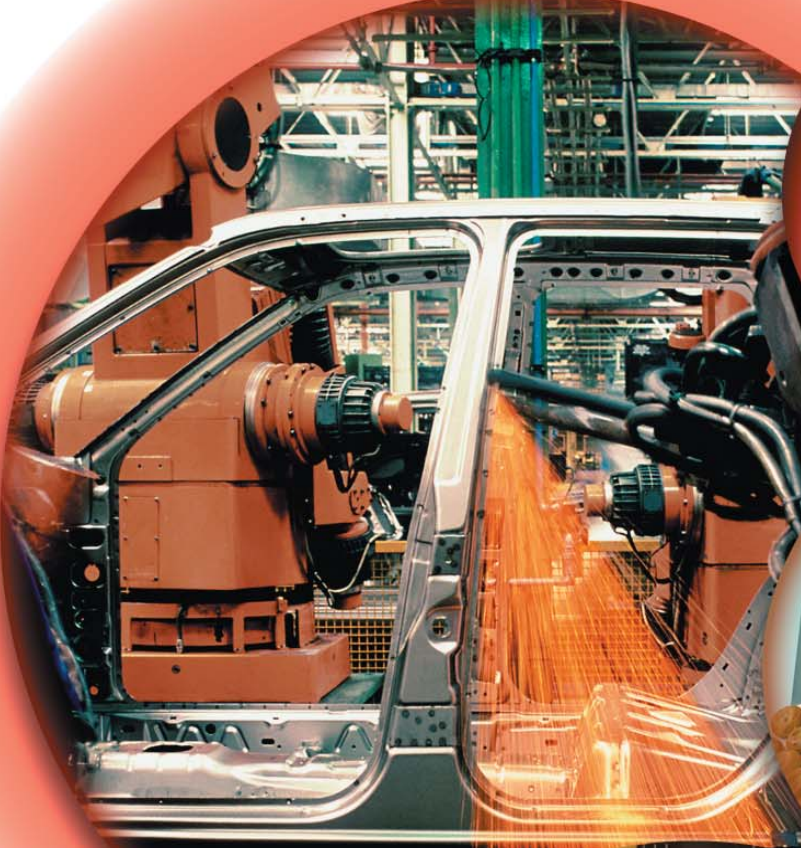

HI-IMPACT™

Complete Communication Solution
for Harsh Environments.

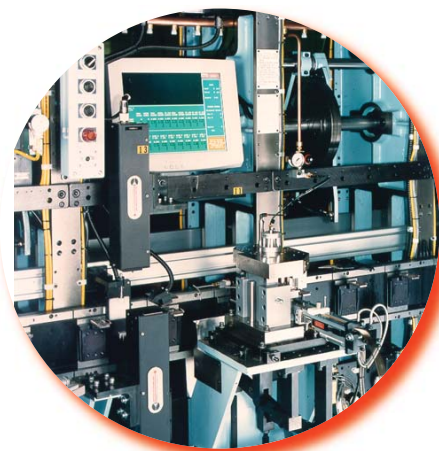

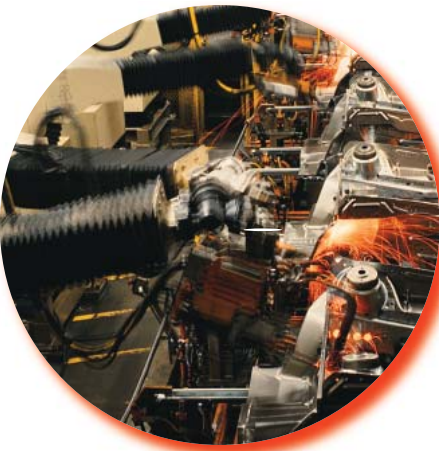

From the most severe industrial to punishing commercial, HI-IMPACT™ System answers the call . . .

In today's competitive market the ability to access "Real Time" data is critical to customer satisfaction. "Real-Time" data supports the global trend of e-commerce, quick-response and vendor-managed inventory systems. Customers and suppliers now have the ability to look at all points in the supply chain, from raw material to finished goods. This ultimately improves responsiveness and provides a competitive edge to be best in class.

The global acceptance of Ethernet protocol has pushed RJ45 connectors from the corporate office to the more demanding industrial and harsh commercial environments. This trend has created the need for a more dynamic and robust solution. In these environments the typical mated connection may corrode, wear, clog with debris, and eventually fail. High maintenance costs, downtime and critical failure are the results, where dust, moisture, temperature extremes, EMI, and vibration are commonplace.

Hubbell's HI-IMPACT™ system is more than just a connection. It is a complete end-to-end communications solution designed to solve problems in the most severe industrial to punishing commercial environments.



. . . Spanning applications from A to Z.

Automated Tellers Machines

Billboards & Display

Educational

K-12

University

Entertainment & Hospitality

Casinos

Convention Center

Entertainment

Fast Food

Hotels

Resorts

Restaurants

Stadiums

Theme Parks

Food

Commercial Kitchens

Fast Food Industry

Food Processing

Geological Testing

Laboratories

Manufacturing

Automation

Automotive

Finishing and Plating

Foundries

Material Handling

Molding

Paper Mills

Pharmaceutical

Process & Control

Robotics Welding

Stamping

Tool & Die

Warehouses

Marinas

Medical

Hospitals

Mobile Medical Units

Military

Mining Industries

Oil Industries

Retail

Supermarkets

Transportation

Airports

Bus Stations

Subways

Train Stations

Utility Companies

Electric Utilities

Refinement & Waste

Treatment facilities

Vending Machines

Wireless

Zoos



HARSH-e A Comprehensive Rating System.

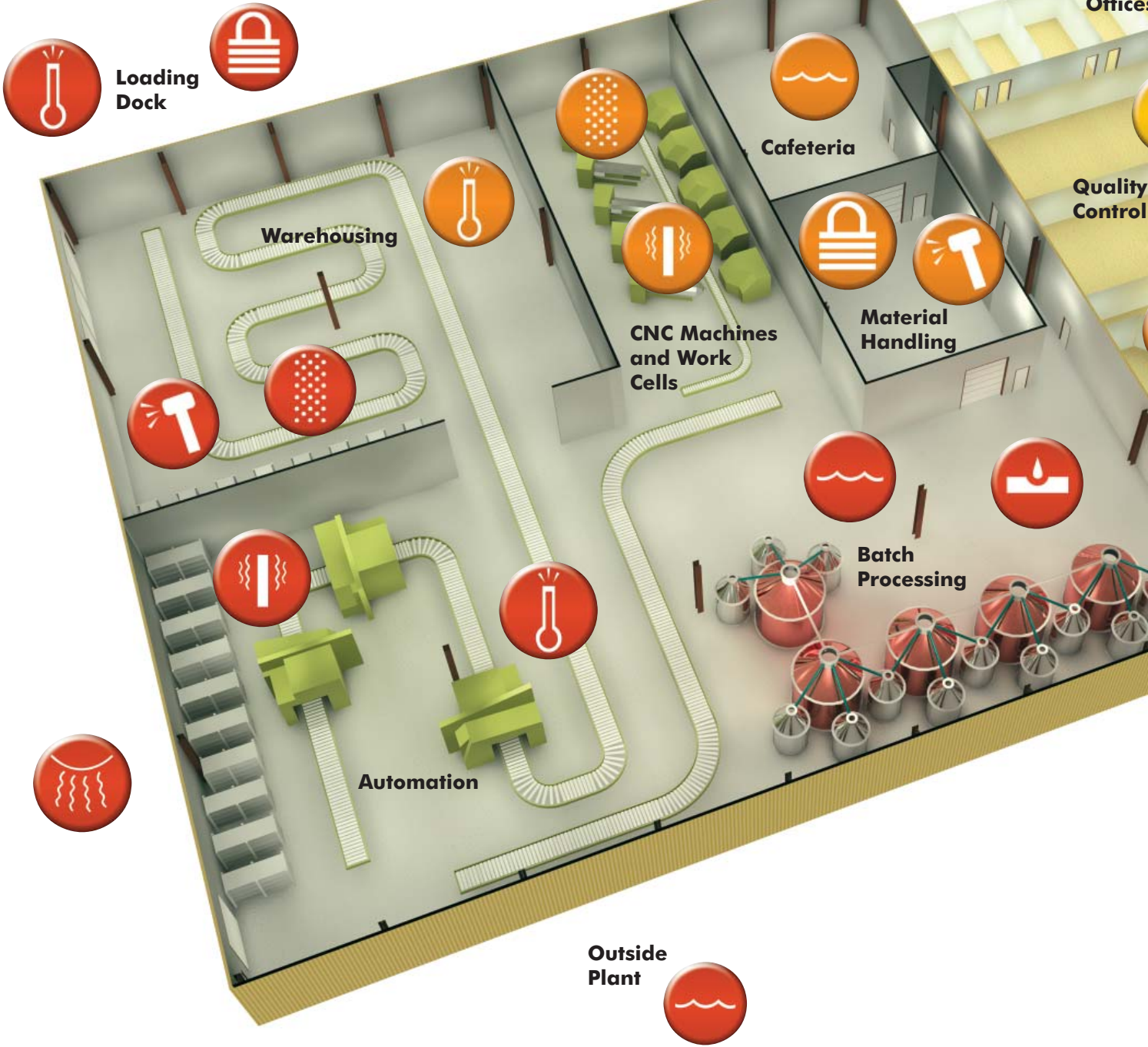





























The **H**ubbell **A**pplications **R**ating **S**ystem for **H**arsh **E**nvironments (HARSH-e) simplifies specifying the right product by categorizing environmental conditions into three classes – severe, harsh and tough.

For each environmental condition, identify the level that best describes your application in the HARSH-e table.

The most severe environmental condition dictates the HARSH-e level for your application.

See the page for the corresponding HARSH-e level for the product set and system components.

HARSH- Hubbell Application Rating System for Harsh Environments

	 e3 Application Severe	 e2 Application Harsh	 e1 Application Tough
Dust	 Enclosures: NEMA 4X Connectors: IP67 and IP66 Totally protected against dust (Dust-tight)	 Enclosures: NEMA 4/12/13 Connectors: IP67 and IP66 Protected against dust, Objects greater than 1 mm	 Enclosures: NEMA 3R Connectors: IP43 Objects greater than 1 mm i.e., tools, wires, small wires
Water	 Enclosures: NEMA 4X Connectors: IP67 and IP66 Immersion and strong pressure jets	 Enclosures: NEMA 4/12/13 Connectors: IP67 and IP66 Protected against strong and low pressure jets	 Enclosures: NEMA 3R Connectors: IP43 Protected against sprays of water to 60° from vertical
Corrosion	 Enclosures: NEMA 4X Stainless Steel: Dust, water and corrosive liquids Connectors: PBT Common oils, chemicals and cleaning agents	 Enclosures: NEMA 4/12/13 Ice, dust, water, non-corrosive liquids Connectors: PBT Common oils	 Enclosures: NEMA 3R Falling rain, sleet Connectors: N/A
Impact	 Enclosures: 14 ga., 304 SS Connector Housing: PBT	 Enclosures: 14 ga., steel Connector Housing: PBT	 Enclosures: 14 ga., steel Connectors: Thermoplastic
Tamper	 Enclosures: Protected, secured and locked	 Enclosures: Protected, and optional locked	 Enclosures: Protected, but not secured
Temperature	 TIA/EIA-568-B.2 TIA/TR 42.9 pending	 TIA/EIA-568-B.2	 TIA/EIA-568-B.2
Vibration	 TIA/TR 42.9 10-500Hz 5g Acceleration	 TIA/TR 42.9 10-500Hz 2g Acceleration	 TIA/TR 42.9 10-500Hz 0.7g Acceleration
Ultra-Violet	 Protected	 Protected	 Not Protected



HI-IMPACT™

Connector Hardware for Harsh Environments.

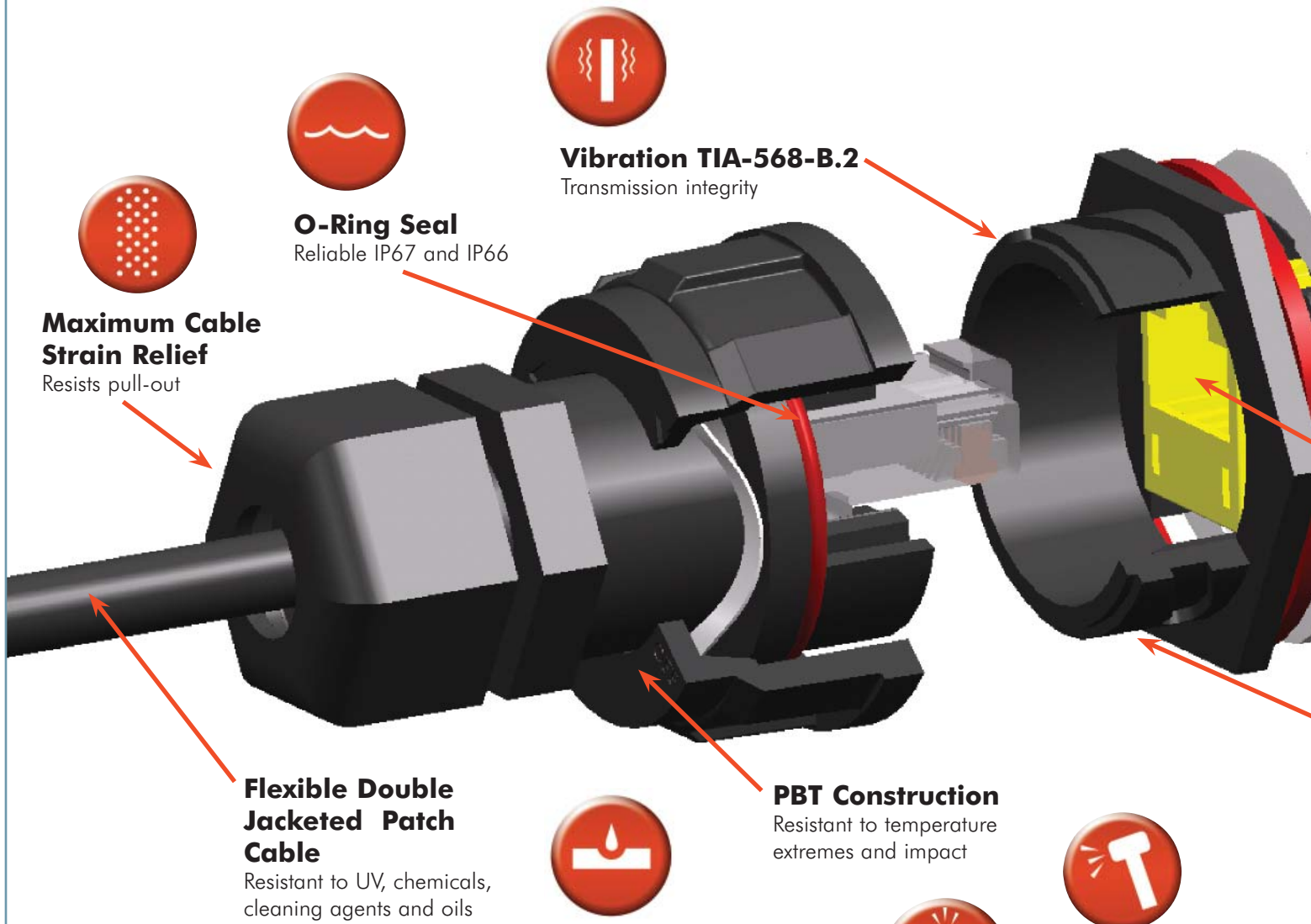

Connectors

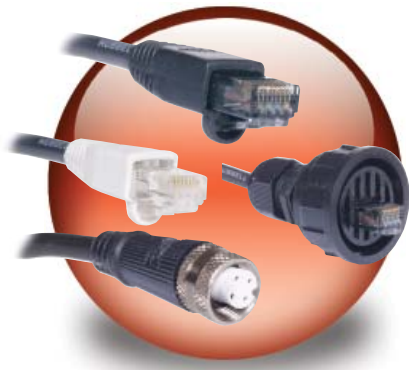

Patch Cords



Plates



Standard 3/4" Knockout
Simplifies installation

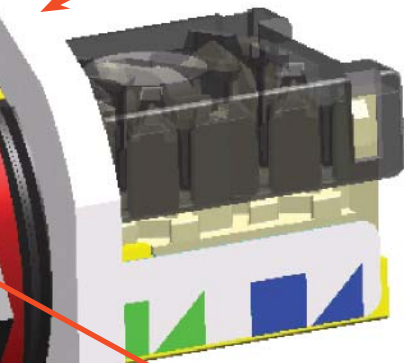

Standard Hubbell Keystone Opening
Provides migration path



User-Friendly Quick Connect
Positive indication when fully engaged



CONNECTOR SPECIFICATIONS

Environmental

- Ingress Protection: IP67 and IP66 (dust and water)
- Corrosion: Resistant to most common chemicals, cleaning agents and oils
- UV: UV resistant (HI-IMPACT Housing)
- Temperature Range: TIA/EIA-568-B.2
TIA/TR 42.9 (product pending)

Mechanical

- Vibration
 - Frequency Range: 10-500Hz
 - Acceleration: 5g
- Mating Cycles: 750 minimum
- UL 1863 listed

Material

- Connector Housing: PBT, UL94V-0
- Nose Contacts: Beryllium copper with a minimum of 50 micro-inch gold plating over nickel under plating
- IDC 110 Contacts: Phosphor bronze with 100 micro-inch tin lead 60/40 plating over nickel under plating

Electrical

- ANSI/TIA/EIA-568-B.2-1 (Category 6)
- ANSI/TIA/EIA-568-B.2 (Category 5e)
- Supports TIA/TR42.9 Industrial Draft
- Supports 4 times IEEE 802.3af DTE power specifications
- Exceeds IEEE 802.3ab Gigabit specifications to $< 1 * 10^{-13}$

Certifications

- UL Listed
- cUL Listed
- CSA Certified
- 3rd Party Verified Category 6 and 5e component



Boxes



Cabinets

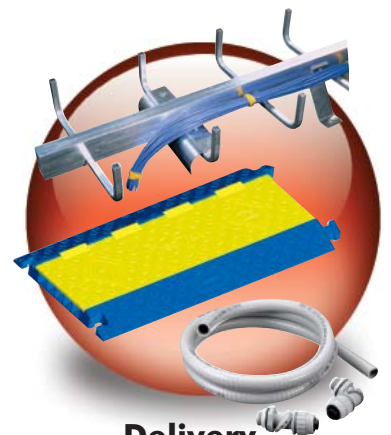

Delivery



3 Severe Environments

HARSH-e3 applications are punishing environments where extreme temperatures, EMI, vibration and exposure to corrosive materials may be present.

Typical Severe Environment Applications

- **Food Processing**
- **Manufacturing**
 - Automation
 - Automotive
 - Finishing and Plating
 - Foundries
 - Molding
 - Paper Mills
 - Process & Control
 - Robotics Welding
 - Stamping
 - Tool & Die
- **Marinas**
- **Pharmaceutical**
- **Utility**
 - Electric Utilities
 - Oil & Mining Refinement & Waste Treatment Facilities



HI-IMPACT™ Product Solutions



Connectors

- Cat 5e
- Cat 5e Coupler
- *F-Connector
- *Cat 6
- *M12



Patch Cords

- Cat 5e
- Cat 6
- Hybrid Series
- M12 to RJ45



Enclosures NEMA 4X

- REBox®
- Consolidation Point
- *Wireless



Plates and Boxes

- FS/FD Plates
- NEMA 4X Control Boxes
- Portable Outlet Boxes
- Weatherproof Box



Delivery

- Center Rack
- TrukTrak®
- LiquidTight® Systems
- Cord Connectors



e2 Harsh Environments

HARSH-e2 applications are harsh environments where hardware is exposed to regular abuse.

Typical Harsh Environment Applications

- Automated Tellers Machines
- Billboards and Display
- Food
 - Commercial Food
 - Fast Food
 - Restaurants
- Laboratories
- Manufacturing
 - Automation
 - Material Handling
 - Warehouses
- Medical
 - Mobile Med Units
- Pharmaceutical
- Retail
- Transportation
 - Airports
 - Bus Stations
 - Subways
 - Train Stations
- Zoos



HI-IMPACT™ Product Solutions



Connectors

- Cat 5e
- Cat 5e Coupler
- *F-Connector
- *Cat 6



Patch Cords

- Cat 5e
- Cat 6



Enclosures NEMA 4/12/13

- REBox®
- Consolidation Point
- *Wireless



Plates and Boxes

- Plates
- NEMA 4/12/13 Control Boxes
- Portable Outlet Boxes
- Die-cast Box

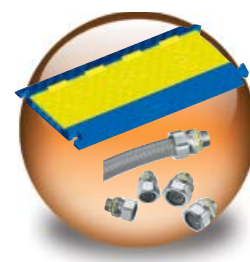

Delivery

- Center Rack
- TredTrak®
- LiquidTight® Systems



1

Tough Environments

HARSH-e1 applications are more demanding than typical commercial environments. Hardware is exposed to occasional rough use.

Typical Tough Environment Applications

■ Hospitality and Entertainment

- Aquariums
- Amusement and Family Entertainment
- Casinos
- Convention Centers
- Hotels
- Resorts
- Stadiums
- Theme Parks

■ Educational

- K-12
- University

■ Grocery/Deli



HI-IMPACT™ Product Solutions



Connectors

- Cat 5e
- Cat 6
- Cat 5e Coupler



Patch Cords

- Cat 5e
- Cat 6



Enclosures NEMA 3R

- REBox®
- *Wireless



Plates and Boxes

- Communication Frames
- Flip Covers
- Bell® Boxes
- Work Boxes
- Secure-IT™ Plate



Delivery

- Center Rack
- TredTrak®
- LiquidTight® Systems



HARSH- A Comprehensive Rating System.

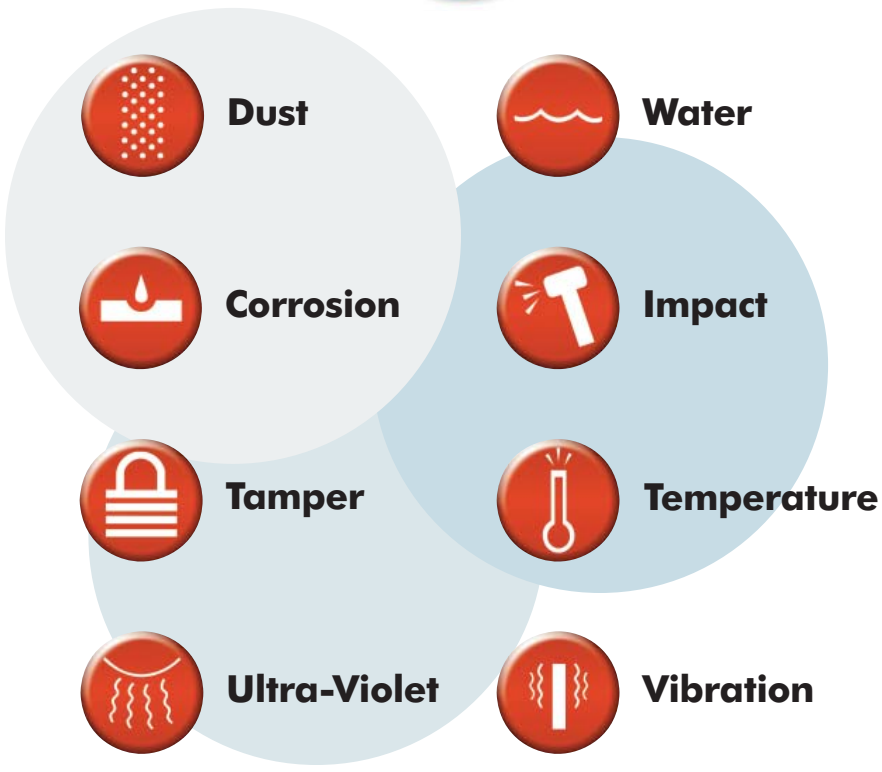

-  **1** TOUGH Environments
-  **2** HARSH Environments
-  **3** SEVERE Environments



Find out more about your Hubbell HI-IMPACT™ Solution.



HUBBELL
Wiring Devices & Systems
KELLEMS Wire Management
Marine Wiring Products

115
YEARS

www.hubbell-wiring.com

Welcome to **Hubbell Wiring Device-Kellems**

For Over 100 Years an Innovative Market Leader in the Electrical Industry

- About Us
- What's New
- Contact Us
- Products & Applications
- Technical Help
- Trade Events
- Hubbell
- Distributor Search
- World Wide Offices
- Hubbell FAQ's
- Product Selectors
- Divisions & Subsidiaries
- Library & Catalogs
- National

HUBBELL PREMISE WIRING
The performance connection

Full Line Catalog

Hubbell-Advantage.com
The Performance Connection

Sales Offices / Distributors • Company Information • Upcoming Events • Press Room • Hubbell Merchandise • Contact Us

Catalogs | Customer Support Center | Training Programs | Mission Critical Warranty | Labeling | Timeline | Site Map

Keyword Part Number

HUBBELL ADVANTAGE

Support

- Online Catalog
- PDF Print Catalogs
- Product Datasheets
- Technical Index
- Tom's Tips
- Product Spotlight

Not a MEMBER yet?
HUB'S CLUB
Hubbell User Group
Log in for Spec Text
AutoCAD, Visio,
Webinars and more

Breaking News

- New! I-Frame**
Hubbell's new iFRAME combines cable management, racking, grounding, and power distribution functions into one simple, strong structural system.
- Raised Access Floor Boxes**
Hubbell's new multi-service APB Series recessed steel boxes are suitable for the majority of standard raised floor applications.

Featured

Online Presentation
Grounding and Bonding with Robert Baxter
Review the TIA 607 standard and applicable NEC articles. Discuss practical applications and why providing a proper ground system is so important for the safety and operation of today's network.



Hubbell Wiring Device-Kellems
Hubbell Incorporated (Delaware)
185 Plains Road
Milford, CT 06460-2420
Tel: (203) 882-4800
Fax: (800) 255-1031
www.hubbell-wiring.com
H5148 03/04



Hubbell Premise Wiring
Hubbell Incorporated (Delaware)
14 Lord's Hill Road
Stonington, CT 06378-0901
Tel: (800) 626-0005
Fax: (860) 535-8328
www.hubbell-premise.com
B-HI6 03/04



Communication Solutions for Harsh Environments



HI-Impact™ Connectors

Call for additional product information



Type	Cat. No.
Cat 6	HBLHI6*
Cat 5e	HBLHI5E
Cat 5e In-Line Coupler	HBLHI5EC
Cat 5e Shielded	HBLHI5ESC
M12 MicroQuick, 4-position, Male	MBMS14314

* Available Q2-2004.

Communication Jacks



Description	Cat. No.
Category 6	HBL6XX
Category 5e	HBL5EXX

XX = Color

BK = Black	B = Blue	EI = Electric Ivory
GY = Gray	GN = Green	OW = Office White
OR = Orange	R = Red	TI = Telco Ivory
W = White	Y = Yellow	

Multimedia Connector

Description	Cat. No.
F-type	HBLHIF**

** Available Q3-2004.

Connector Cover

Description	Cat. No.
Protective Cover	HBLHIC

HI-Impact™ Frames

Call for additional product information

StyleLine® Frames

Ports	Cat. No.
2	FCX244XX
3	FCX344XX
4	FCX444XX
6	FCX644XX



Duplex Frames

Ports	Cat. No.
2	DJOXX
4	DJ106XX



xx = Color	EI = Electric Ivory
BK = Black	OW = Office White
GY = Gray	
W = White	

HI-Impact™ Plates

Call for additional product information

Stainless Steel

Ports	Gang	Cat. No.
1	1	HBLHISF11
2	1	HBLHISF12
2	2	HBLHISF22
4	2	HBLHISF24



Thermoplastic, 4-Point FS/FD, 1-Gang

Ports	Color	Cat. No.
1	Gray	HBLHI14GY
2	Gray	HBLHI24GY
1	Yellow	HBLHI14PY
2	Yellow	HBLHI24PY



Flip-Cover, Die-Cast Aluminum, Vertical, 1-Gang

Type	Cat. No.
Device	WP26
FS/FD	WPFS26



Flip-Cover, Thermoplastic, Vertical, 1-Gang

Type	Cat. No.
Device	HBL5222
FS/FD	HBL5221



Weatherproof, NEMA 3R

Horizontal	Gang	Cat. No.
Weatherproof	1	WP826MHP



Vertical	Gang	Cat. No.
Weatherproof	1	WP826MP
Weatherproof	2	WP8262MP



Vertical	Gang	Cat. No.
Secure-IT™	1	HBLTWP1GY

HI-Impact™ Boxes

Call for additional product information

Fiberglass Weatherproof Device Box with Lugs

Knockout	Color	Cat. No.
3/4"	Yellow	HBL60CM83



Cast Aluminum Device Box with Lugs

Knockout	Color	Cat. No.
1/2"	Gray	HBLHIFD1L*
3/4"	Gray	HBLHIFD2L*

* Available Q2-2004.

Cast Aluminum Weatherproof Device Box with Lugs

Knockout	Color	Cat. No.
1/2"	Gray	HBLHIWP05GY*
3/4"	Gray	HBLHIWP75GY*

* Available Q2-2004.

NEMA 4X Box

Ports	Cat. No.
1	HBLHI14XGY*
2	HBLHI24XGY*
4	HBLHI44XGY*
6	HBLHI64XGY*



Stainless Steel

Ports	Cat. No.
1	HBLHI1CBSS*
2	HBLHI2CBSS*

* Available Q2-2004.



NEMA 4/12 Box

Stainless Steel, Gray	Port	Cat. No.
	1	HBLHI1CBG*
	2	HBLHI2CBG*

* Available Q2-2004.



Portable Outlet with Strain Relief Kit

Port	Cat. No.
1	HBLHI1POB*
Multiport	HBLHIPOB*

* Available Q3-2004.

HI-Impact™ Cords
Call for additional product information

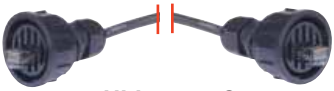

HI-Impact to HI-Impact Connector

Type	Cat. No.
Cat 6	HBLHI6XXEE*
Cat 5e	HBLHI5EXXEE
Cat 5e, Shielded	HBLHI5ESXXEE**
F-type	HBLHIFXXEE**
M12, 4-position female	HBLHIM12XXEE**



HI-Impact Connector to RJ-45

Type	Cat. No.
Cat 6	HBLHI6XXAE*
Cat 5e	HBLHI5EXXAE
Cat 5e, Shielded	HBLHI5ESXXAE**
F-type	HBLHIFXXAE**
M12, 4-position female	HBLHIM12XXAE**



HI-Impact RJ-45 to RJ-45

Type	Cat. No.
Cat 6	HBLHI6XXAA*
Cat 5e	HBLHI5EXXAA
Cat 5e, Shielded	HBLHI5ESXXAA**

XX = Length

03 = 3'	05 = 5'	07 = 7'
10 = 10'	12 = 12'	15 = 15'
20 = 20'	25 = 25'	

* Available Q2-2004.

** Available Q3-2004.

HI-Impact™ Plugs and Cable
Call for additional product information

Type	Cat. No.
Cat 5e Plug	HBLHI5EP
Cat 5e Patch Cable, 100'	HBLHIPC100
F-type Connector	HBLHIFP**
RG-59 Patch Cable, 100'	HBLHIFC100**

** Available Q3-2004.

HI-Impact™ Cord Connectors & Grips
Call for additional product information



Cord Connectors, 0.250" - 0.375"

Description	Cat. No.
SS, 1/2"	SHC1022SS
Aluminum, 1/2"	SHC1022
Aluminum, 3/4"	SHC1032
Nylon, Gray, 3/4"	SHC1022CR

Deluxe Cord Connectors, 0.250" - 0.375"

Description	Cat. No.
SS, 1/2"	07401006
SS, 3/4"	07401013
Aluminum, 1/2"	CG406NM
Nylon, Gray, 1/2"	074011332

HI-Impact™ Enclosures
Call for additional product information



REBOX® NEMA 4/12/13, Gray

Height	Type	Cat. No.
24"	Unloaded	HBLIR2UG
36"	Unloaded	HBLIR3UG
48"	Unloaded	HBLIR4UG
36"	Loaded	HBLIR3PG
48"	Loaded	HBLIR4PG

REBOX® NEMA 4X, Stainless Steel

Height	Type	Cat. No.
24"	Unloaded	HBLIR2USS*
36"	Unloaded	HBLIR3USS*

REBOX® NEMA 3R, Gray

Height	Type	Cat. No.
24"	Unloaded	HBLIR2U2R
36"	Unloaded	HBLIR2U3R

REBOX® Accessories

Description	Cat. No.
Plywood Backboard 20"H x 19"W	HBLREKBB20
30"H x 19"W	HBLREKBB30
40"H x 19"W	HBLREKBB40
Equipment Mounting Bracket, 5U	HBLREKZ
110/66 Block Mounting Rails (accepts five 100-pair/110-pair blocks)	HBLREK110
Patch Panel Bracket Bottom-hinged, 4U	HBLREK19
Fiber Patch Panel Bracket (accepts 1 FSP panel)	HBLREKFP
Economy Power Supply Kit, 15A	HBLREKP

DIN Rail Utility Box, Duplex



Description	Cat. No.
15A/5A Breaker	DRUBTVSS15
Duplex, Comm., 2-port	HBLHIDRUBC2**
Duplex, Comm., 4-port	HBLHIDRUBC4**

** Available Q3-2004.

Consolidation Point



Type	Size	Cat. No.
SS	NEMA 4X	HBLHICPSS*
Gray	NEMA 4/12	HBLHICP412G*

* Available Q2-2004.

HI-Impact™ Delivery
Call for additional product information

PolyTuff Conduit



Size	Feet	Cat. No.
1/2"	100	G1050
3/4"	100	G1075

LiquidTight, Metallic Fittings



Size	Fitting Type	Cat. No.
1/2"	Straight Male	H0501A
3/4"	Straight Male	H0751A

LiquidTight, Non-Metallic Fittings



Size	Fitting Type	Cat. No.
1/2"	Straight Male	P050NGYA
3/4"	Straight Male	P075NGYA
1/2"	SwivelLok® Male	PS0509NGY
3/4"	SwivelLok® Male	PS0759NGY

TredTrak, 5-Channel

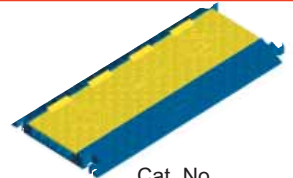

Description	Cat. No.
Track, 3' Section	HBLTRED5B
End Caps	HBLTRED5ECB
"X" Section	HBLTRED5XB
"Y" Section	HBLTRED5YB

TrukTrak, 5-Channel



Description	Cat. No.
Track, 3' Section	HBLTT5B
End Caps	HBLTT5ECB
Right Turn	HBLTT545RB
Left Turn	HBLTT545LB

H5148LC 03/04



© Hubbell Wiring Device-Kellems
Hubbell Incorporated (Delaware)
1-203-882-4800
www.hubbell-wiring.com

www.hubbell-solutions.com/Hi-Impact



Communication Solutions for Harsh Environments



HI-Impact™ Connectors

Call for additional product information



Type	WDK Cat. No.	HPW Cat. No.
Cat 6	HBLHI6*	HI6*
Cat 5e	HBLHI5E	HI5E
Cat 5e In-Line Coupler	HBLHI5EC	HI5EC
Cat 5e Shielded	HBLHI5ESC	HI5ESC
M12 MicroQuick, 4-position, Male	MBMS14314	MBMS14314HI*

* Available Q2-2004.

Communication Jacks



Description	WDK Cat. No.	HPW Cat. No.
Category 6	HBL6XX	HXJ6XX
Category 5e	HBL5EXX	HXJ5EXX

XX = Color

- BK** = Black
- GN** = Green
- OR** = Orange
- W** = White
- BL** = Blue
- GN** = Green
- R** = Red
- Y** = Yellow
- EI** = Electric Ivory
- OW** = Office White
- TI** = Telco Ivory

Multimedia Connector

Description	WDK Cat. No.	HPW Cat. No.
F-type	HBLHIF**	HIF**

** Available Q3-2004.

Connector Cover

Description	WDK Cat. No.	HPW Cat. No.
Protective Cover	HBLHIC	HIC

HI-Impact™ Frames

Call for additional product information

StyleLine® Frames

Ports	WDK Cat. No.	HPW Cat. No.
2	FCX244XX	ISF2XX
3	FCX344XX	ISF3XX
4	FCX444XX	ISF4XX
6	FCX644XX	ISF6XX

Duplex Frames

Ports	WDK Cat. No.	HPW Cat. No.
2	DJ0XX	BR106XX
4	DJ106XX	Q106XX

xx = Color

- BK** = Black
- GN** = Green
- W** = White
- EI** = Electric Ivory
- OW** = Office White

HI-Impact™ Plates

Call for additional product information

Stainless Steel

Ports	Gang	WDK Cat. No.	HPW Cat. No.
1	1	HBLHISF11	HISF11
2	1	HBLHISF12	HISF12
2	2	HBLHISF22	HISF22
4	2	HBLHISF24	HISF24

Thermoplastic, 4-Point FS/FD, 1-Gang

Ports	Color	WDK Cat. No.	HPW Cat. No.
1	Gray	HBLHI14GY	HI14GY
2	Gray	HBLHI124GY	HI24GY
1	Yellow	HBLHI114PY	HI114PY
2	Yellow	HBLHI124PY	HI124PY

Flip-Cover, Die-Cast Aluminum, Vertical, 1-Gang

Type	WDK Cat. No.	HPW Cat. No.
Device	WP26	WP26HI
FS/FD	WPFS26	WPFS26HI

Flip-Cover, Thermoplastic, Vertical, 1-Gang

Type	WDK Cat. No.	HPW Cat. No.
Device	HBL5222	HBL5222HI
FS/FD	HBL5221	HBL5221HI

Weatherproof, NEMA 3R

Horizontal	Gang	WDK Cat. No.	HPW Cat. No.
Weatherproof	1	WP826MHP	WP826MHPHI

Vertical	Gang	WDK Cat. No.	HPW Cat. No.
Weatherproof	1	WP826MP	WP826MPHI
Weatherproof	2	WP8262MP	WP8262MPHI

Vertical	Gang	WDK Cat. No.	HPW Cat. No.
Secure-IT™	1	HBLTWP1GY	TWPF1GY

HI-Impact™ Boxes

Call for additional product information

Fiberglass Weatherproof Device Box with Lugs

Knockout	Color	WDK Cat. No.	HPW Cat. No.
3/4"	Yellow	HBL60CM83	HBL60CM83HI

Cast Aluminum Device Box with Lugs

Knockout	Color	WDK Cat. No.	HPW Cat. No.
1/2"	Gray	HBLHIFD1L*	HIFD1L*
3/4"	Gray	HBLHIFD2L*	HIFD2L*

* Available Q2-2004.

Cast Aluminum Weatherproof Device Box with Lugs

Knockout	Color	WDK Cat. No.	HPW Cat. No.
1/2"	Gray	HBLHIWP05GY*	HIWP05GY*
3/4"	Gray	HBLHIWP75GY*	HIWP75GY*

* Available Q2-2004.

NEMA 4X Box

Thermoplastic, Gray

Ports	WDK Cat. No.	HPW Cat. No.
1	HBLHI14XGY*	HI14XGY*
2	HBLHI24XGY*	HI24XGY*
4	HBLHI44XGY*	HI44XGY*
6	HBLHI64XGY*	HI64XGY*

Stainless Steel

Ports	WDK Cat. No.	HPW Cat. No.
1	HBLHI1CBSS*	HI1CBSS*
2	HBLHI2CBSS*	HI2CBSS*

* Available Q2-2004.

NEMA 4/12 Box

Stainless Steel, Gray

Port	WDK Cat. No.	HPW Cat. No.
1	HBLHI1CBG*	HI1CBG*
2	HBLHI2CBG*	HI2CBG*

* Available Q2-2004.

Portable Outlet with Strain Relief Kit

Port	WDK Cat. No.	HPW Cat. No.
1	HBLHI1POB*	HI1POB*
Multiport	HBLHIPOB*	HIPOB*

* Available Q3-2004.

HI-Impact™ Cords

Call for additional product information



HI-Impact to HI-Impact Connector

Type	WDK Cat. No.	HPW Cat. No.
Cat 6	HBLHI6XXEE*	HI6XXEE*
Cat 5e	HBLHI5EXXEE	HI5EXXEE
Cat 5e, Shielded	HBLHI5ESXXEE**	HI5ESXXEE**
F-type	HBLHIFXXEE**	HIFXXEE**
M12, 4-position female	HBLHIM12XXEE**	HIM12XXEE**



HI-Impact Connector to RJ-45

Type	WDK Cat. No.	HPW Cat. No.
Cat 6	HBLHI6XXAE*	HI6XXAE*
Cat 5e	HBLHI5EXXAE	HI5EXXAE
Cat 5e, Shielded	HBLHI5ESXXAE**	HI5ESXXAE**
F-type	HBLHIFXXAE**	HIFXXAE**
M12, 4-position female	HBLHIM12XXAE**	HIM12XXAE**



HI-Impact RJ-45 to RJ-45

Type	WDK Cat. No.	HPW Cat. No.
Cat 6	HBLHI6XXAA*	HI6XXAA*
Cat 5e	HBLHI5EXXAA	HI5EXXAA
Cat 5e, Shielded	HBLHI5ESXXAA**	HI5ESXXAA**

XX = Length
 03 = 3' 05 = 5' 07 = 7' 10 = 10'
 12 = 12' 15 = 15' 20 = 20' 25 = 25'

* Available Q2-2004.

** Available Q3-2004.

HI-Impact™ Plugs and Cable

Call for additional product information

Type	WDK Cat. No.	HPW Cat. No.
Cat 5e Plug	HBLHI5EP	HI5EP
Cat 5e Patch Cable, 100'	HBLHIPC100	HIPC100
F-type Connector	HBLHIFP**	HIFP**
RG-59 Patch Cable, 100'	HBLHIFC100**	HIFC100**

** Available Q3-2004.

HI-Impact™ Cord Connectors & Grips

Call for additional product information



Cord Connectors, 0.250" - 0.375"

Description	WDK Cat. No.	HPW Cat. No.
SS, 1/2"	SHC1022SS	SHC1022SSHI
Aluminum, 1/2"	SHC1022	SHC1022HI
Aluminum, 3/4"	SHC1032	SHC1032HI
Nylon, Gray, 3/4"	SHC1022CR	SHC1022CRHI

Deluxe Cord Connectors, 0.250" - 0.375"

Description	WDK Cat. No.	HPW Cat. No.
SS, 1/2"	07401006	07401006HI
SS, 3/4"	07401013	07401013HI
Aluminum, 1/2"	CG406NM	CG406NMHI
Nylon, Gray, 1/2"	074011332	074011332HI

HI-Impact™ Enclosures

Call for additional product information



REBOX® NEMA 4/12/13, Gray

Height	Type	WDK Cat. No.	HPW Cat. No.
24"	Unloaded	HBLIR2UG	IR2UG
36"	Unloaded	HBLIR3UG	IR3UG
48"	Unloaded	HBLIR4UG	IR4UG
36"	Loaded	HBLIR3PG	IR3PG
48"	Loaded	HBLIR4PG	IR4PG

REBOX® NEMA 4X, Stainless Steel

Height	Type	WDK Cat. No.	HPW Cat. No.
24"	Unloaded	HBLIR2USS*	IR2USS*
36"	Unloaded	HBLIR3USS*	IR3USS*

REBOX® NEMA 3R, Gray

Height	Type	WDK Cat. No.	HPW Cat. No.
24"	Unloaded	HBLIR2U2R	IR2U2R
36"	Unloaded	HBLIR2U3R	IR2U3R

REBOX® Accessories

Description	WDK Cat. No.	HPW Cat. No.
Plywood Backboard 20"H x 19"W	HBLREKBB20	REKBB20
30"H x 19"W	HBLREKBB30	REKBB30
40"H x 19"W	HBLREKBB40	REKBB40
Equipment Mounting Bracket, 5U	HBLREKZ	REKZ
110/66 Block Mounting Rails (accepts five 100-pair/110-pair blocks)	HBLREK110	REK110
Patch Panel Bracket Bottom-hinged, 4U	HBLREK19	REK19
Fiber Patch Panel Bracket (accepts 1 FSP panel)	HBLREKFP	REKFP
Economy Power Supply Kit, 15A	HBLREKP	REKP

DIN Rail Utility Box, Duplex

Description	WDK Cat. No.	HPW Cat. No.
15A/5A Breaker 2-port	DRUBTVSS15	DRUBTVSS15HI*
Duplex, Comm.	HBLHIDRUBC2**	HIDRUBC2**
Duplex, Comm.	HBLHIDRUBC4**	HIDRUBC4**

* Available Q2-2004. ** Available Q3-2004.

Consolidation Point

Type	Size	WDK Cat. No.	HPW Cat. No.
SS	NEMA 4X	HBLHICPSS*	HICPSS*
Gray	NEMA 4/12	HBLHICP412G*	HICP412G*

* Available Q2-2004.



HI-Impact™ Delivery

Call for additional product information

PolyTuff Conduit



Size	Feet	WDK Cat. No.	HPW Cat. No.
1/2"	100	G1050	G1050HI
3/4"	100	G1075	G1075HI

LiquidTight, Metallic Fittings



Size	Fitting Type	WDK Cat. No.	HPW Cat. No.
1/2"	Straight Male	H0501A	H0501AHI
3/4"	Straight Male	H0751A	H0751AHI

LiquidTight, Non-Metallic Fittings



Size	Fitting Type	WDK Cat. No.	HPW Cat. No.
1/2"	Straight Male	P050NGYA	P050NGYAH
3/4"	Straight Male	P075NGYA	P075NGYAH
1/2"	SwivelLok® Male	PS0509NGY	PS0509NGYHI
3/4"	SwivelLok® Male	PS0759NGY	PS0759NGYHI

TredTrak, 5-Channel

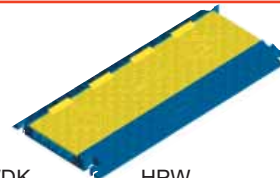

Description	WDK Cat. No.	HPW Cat. No.
Track, 3' Section	HBLTRED5B	HBLTRED5BHI
End Caps	HBLTRED5ECB	HBLTRED5ECBHI
"X" Section	HBLTRED5XB	HBLTRED5XBHI
"Y" Section	HBLTRED5YB	HBLTRED5YBHI

TrukTrak, 5-Channel

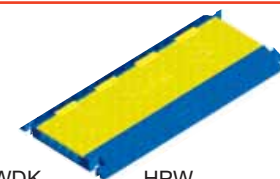

Description	WDK Cat. No.	HPW Cat. No.
Track, 3' Section	HBLTT5B	HBLTT5BHI
End Caps	HBLTT5ECB	HBLTT5ECBHI
Right Turn	HBLTT545RB	HBLTT545RBHI
Left Turn	HBLTT545LB	HBLTT545LBHI

H5148LCGBR 03/04



Hubbell Wiring Device-Kellems
Hubbell Incorporated (Delaware)
1-203-882-4800
www.hubbell-wiring.com

Hubbell Premise Wiring
Hubbell Incorporated (Delaware)
1-800-626-0005
www.hubbell-premise.com

www.hubbell-solutions.com/Hi-Impact



Communication Solutions for Harsh Environments



HI-Impact™ Connectors

Call for additional product information



Type	Cat. No.
Cat 6	HI6*
Cat 5e	HI5E
Cat 5e In-Line Coupler	HI5EC
Cat 5e Shielded	HI5ESC
M12 MicroQuick, 4-position, Male	MBMS14314HI*

* Available Q2-2004.

Communication Jacks



Description	Cat. No.
Category 6	HXJ6XX
Category 5e	HXJ5EXX

XX = Color

BK = Black	B = Blue	EI = Electric Ivory
GY = Gray	GN = Green	OW = Office White
OR = Orange	R = Red	TI = Telco Ivory
W = White	Y = Yellow	

Multimedia Connector

Description	Cat. No.
F-type	HIF**

** Available Q3-2004.



Connector Cover

Description	Cat. No.
Protective Cover	HIC



HI-Impact™ Frames

Call for additional product information

StyleLine® Frames

Ports	Cat. No.
2	ISF2XX
3	ISF3XX
4	ISF4XX
6	ISF6XX



Duplex Frames

Ports	Cat. No.
2	BR106XX
4	Q106XX



xx = Color

BK = Black	EI = Electric Ivory
GY = Gray	OW = Office White
W = White	

HI-Impact™ Plates

Call for additional product information

Stainless Steel

Ports	Gang	Cat. No.
1	1	HISF11
2	1	HISF12
2	2	HISF22
4	2	HISF24



Thermoplastic, 4-Point FS/FD, 1-Gang

Ports	Color	Cat. No.
1	Gray	HI14GY
2	Gray	HI24GY
1	Yellow	HI114PY
2	Yellow	HI124PY



Flip-Cover, Die-Cast Aluminum, Vertical, 1-Gang

Type	Cat. No.
Device	WP26HI
FS/FD	WPFS26HI



Flip-Cover, Thermoplastic, Vertical, 1-Gang

Type	Cat. No.
Device	HBL5222HI
FS/FD	HBL5221HI



Weatherproof, NEMA 3R



Horizontal	Gang	Cat. No.
Weatherproof	1	WP826MHPHI

Vertical	Gang	Cat. No.
Weatherproof	1	WP826MPHI
Weatherproof	2	WP8262MPHI



Vertical	Gang	Cat. No.
Secure-IT™	1	TWPF1GY

HI-Impact™ Boxes

Call for additional product information

Fiberglass Weatherproof Device Box with Lugs



Knockout	Color	Cat. No.
3/4"	Yellow	HBL60CM83HI

Cast Aluminum Device Box with Lugs

Knockout	Color	Cat. No.
1/2"	Gray	HIFD1L*
3/4"	Gray	HIFD2L*

* Available Q2-2004.

Cast Aluminum Weatherproof Device Box with Lugs

Knockout	Color	Cat. No.
1/2"	Gray	HIWP05GY*
3/4"	Gray	HIWP75GY*

* Available Q2-2004.

NEMA 4X Box

Thermoplastic, Gray

Ports	Cat. No.
1	HI14XGY*
2	HI24XGY*
4	HI44XGY*
6	HI64XGY*



Stainless Steel

Ports	Cat. No.
1	HI1CBSS*
2	HI2CBSS*

* Available Q2-2004.



NEMA 4/12 Box

Stainless Steel, Gray

Port	Cat. No.
1	HI1CBG*
2	HI2CBG*

* Available Q2-2004.



Portable Outlet with Strain Relief Kit

Port	Cat. No.
1	HI1POB*
Multiport	HIPOB*

* Available Q3-2004.

HI-Impact™ Cords
Call for additional product information

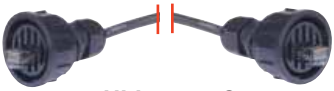

HI-Impact to HI-Impact Connector

Type	Cat. No.
Cat 6	HI6XXEE*
Cat 5e	HI5XXEE
Cat 5e, Shielded	HI5ESXXEE**
F-type	HIFXXEE**
M12, 4-position female	HIM12XXEE**



HI-Impact Connector to RJ-45

Type	Cat. No.
Cat 6	HI6XXAE*
Cat 5e	HI5XXAE
Cat 5e, Shielded	HI5ESXXAE**
F-type	HIFXXAE**
M12, 4-position female	HIM12XXAE**



HI-Impact RJ-45 to RJ-45

Type	Cat. No.
Cat 6	HI6XXAA*
Cat 5e	HI5XXAA
Cat 5e, Shielded	HI5ESXXAA**

XX = Length

03 = 3'	05 = 5'	07 = 7'
10 = 10'	12 = 12'	15 = 15'
20 = 20'	25 = 25'	

* Available Q2-2004.

** Available Q3-2004.

HI-Impact™ Plugs and Cable
Call for additional product information

Type	Cat. No.
Cat 5e Plug	HI5EP
Cat 5e Patch Cable, 100'	HIPC100
F-type Connector	HIFP**
RG-59 Patch Cable, 100'	HIFC100**

** Available Q3-2004.

HI-Impact™ Cord Connectors & Grips
Call for additional product information



Cord Connectors, 0.250" - 0.375"

Description	Cat. No.
SS, 1/2"	SHC1022SSHI
Aluminum, 1/2"	SHC1022HI
Aluminum, 3/4"	SHC1032HI
Nylon, Gray, 3/4"	SHC1022CRHI

Deluxe Cord Connectors, 0.250" - 0.375"

Description	Cat. No.
SS, 1/2"	07401006HI
SS, 3/4"	07401013HI
Aluminum, 1/2"	CG406NMHI
Nylon, Gray, 1/2"	074011332HI

HI-Impact™ Enclosures
Call for additional product information



REBOX® NEMA 4/12/13, Gray

Height	Type	Cat. No.
24"	Unloaded	IR2UG
36"	Unloaded	IR3UG
48"	Unloaded	IR4UG
36"	Loaded	IR3PG
48"	Loaded	IR4PG

REBOX® NEMA 4X, Stainless Steel

Height	Type	Cat. No.
24"	Unloaded	IR2USS*
36"	Unloaded	IR3USS*

REBOX® NEMA 3R, Gray

Height	Type	Cat. No.
24"	Unloaded	IR2U2R
36"	Unloaded	IR2U3R

REBOX® Accessories

Description	Cat. No.
Plywood Backboard 20"H x 19"W	REKBB20
30"H x 19"W	REKBB30
40"H x 19"W	REKBB40
Equipment Mounting Bracket, 5U	REKZ
110/66 Block Mounting Rails (accepts five 100-pair/110-pair blocks)	REK110
Patch Panel Bracket Bottom-hinged, 4U	REK19
Fiber Patch Panel Bracket (accepts 1 FSP panel)	REKFP
Economy Power Supply Kit, 15A	REKP

DIN Rail Utility Box, Duplex



Description	Cat. No.
15A/5A Breaker	DRUBTVSS15HI
Duplex, Comm., 2-port	HIDRUBC2**
Duplex, Comm., 4-port	HIDRUBC4**

** Available Q3-2004.

Consolidation Point



Type	Size	Cat. No.
SS	NEMA 4X	HICPSS*
Gray	NEMA 4/12	HICP412G*

* Available Q2-2004.

HI-Impact™ Delivery
Call for additional product information

PolyTuff Conduit



Size	Feet	Cat. No.
1/2"	100	G1050HI
3/4"	100	G1075HI

LiquidTight, Metallic Fittings



Size	Fitting Type	Cat. No.
1/2"	Straight Male	H0501AHI
3/4"	Straight Male	H0751AHI

LiquidTight, Non-Metallic Fittings



Size	Fitting Type	Cat. No.
1/2"	Straight Male	P050NGYAH1
3/4"	Straight Male	P075NGYAH1
1/2"	SwivelLok® Male	PS0509NGYHI
3/4"	SwivelLok® Male	PS0759NGYHI

TredTrak, 5-Channel

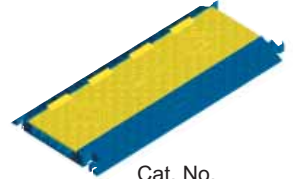

Description	Cat. No.
Track, 3' Section	HBLTRED5BHI
End Caps	HBLTRED5ECBHI
"X" Section	HBLTRED5XBHI
"Y" Section	HBLTRED5YBHI

TrukTrak, 5-Channel



Description	Cat. No.
Track, 3' Section	HBLTT5BHI
End Caps	HBLTT5ECBHI
Right Turn	HBLTT545RBHI
Left Turn	HBLTT545LBHI



© Hubbell Premise Wiring
Hubbell Incorporated (Delaware)
1-800-626-0005
www.hubbell-premise.com

www.hubbell-solutions.com/Hi-Impact