

As experienced experts we support our customers and partners around the world with products, solutions and services in the industrial environment of power, signal and data. We are at home in their industries and markets and know the technological challenges of tomorrow. We are therefore continuously developing innovative, sustainable and useful solutions for their individual needs. Together we set standards in Industrial Connectivity.

We cannot guarantee that there are no mistakes in the publications or software provided by us to the customer for the purpose of making orders. We try our best to quickly correct errors in our printed media.

All orders are based on our general terms of delivery, which can be reviewed on the websites of our group companies where you place your order. On demand we can also send the general terms of delivery to you.

**Efficient wiring through the control cabinet wall**  
**Heavy duty connectors and terminal blocks combined in one solution**  
Let's connect.



# Control cabinet wiring re-invented

space-saving, modular, simple

As automation complexity increases installation space in the control cabinet becomes more valuable and must be used efficiently. This calls for connection solutions that are both modular, combining power, signals and data in one interface and that speed up the installation process by the using state of the art connection technology.

This is what the new RockStar® ModuPlug terminal block modules with PUSH IN connection technology offer. They open up new wiring possibilities, especially for signal distribution. Combined with mounting brackets and IP 67 housings, devices can be connected to the field through the heavy-duty connectors without the use of terminal blocks in the cabinet.



### Double benefit

All the advantages of the modular terminal block, such as easy-to-read markers and pluggable cross-connections, combined with the flexibility and modularity of the heavy-duty RockStar® ModuPlug connectors.

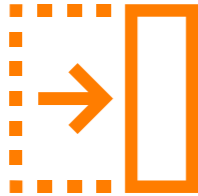

### Optimum use of installation space

The innovative terminal solution in the connector frees up space in the cabinet and reduces the time needed for installation.



### Efficient wiring

Connect signals from the field directly to the device without detours through terminal blocks. The PUSH IN terminals insure safe and quick connections.



## A combination with new strengths

### Heavy duty connectors with terminal block modules

Reach your destination faster with webcodes

Use the webcodes to get directly to the product: deactivate pop-up blocker and enter webcode into the search mask on [www.weidmueller.com](http://www.weidmueller.com)

#### RockStar® ModuPlug system solution

- Modular design for plug & play solutions
- High density for more space in the control cabinet
- Pre-wiring saves time and costs
- Fast and reliable wiring thanks to PUSH IN connection technology

Up to  
48 poles

#### 1. terminal block modules #11511

- 4-pole modules in slim design with 75 mm grid dimension for optimum use of installation space
- Connections for 2- to 12-pole cross-connectors
- Flexible markers, easily readable from any position

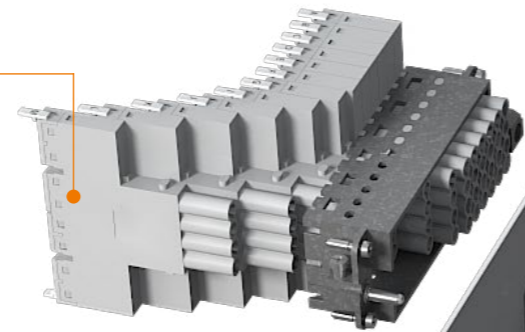

#### 2. sliding frame #11509, #11508

- Fixed positions for opening and closing
- Simple, tool-free assembly of the modules
- Four frame sizes with up to 12 module slots

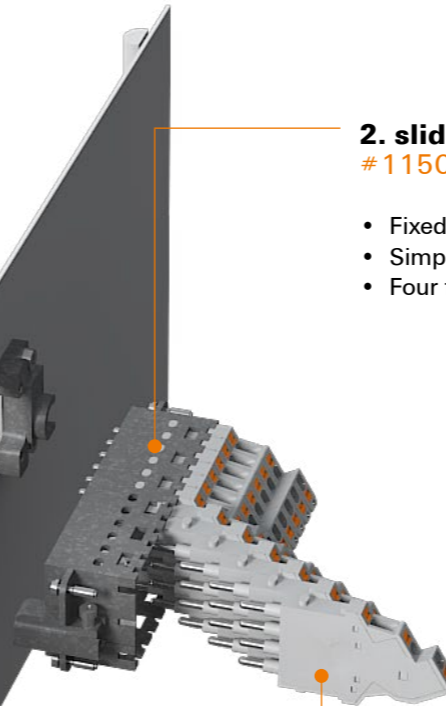

#### 5. plastic housing #11506

- Protection type IP 66/67
- Limit temperature: -40 °C ... 100 °C
- Suitable sizes for all frame variants with straight and side outlets

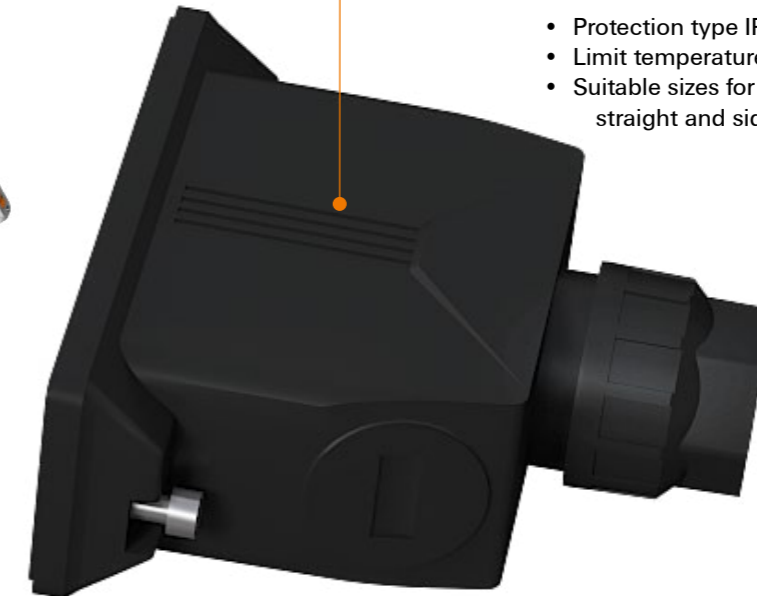

#### 3. mounting bracket #11507

- Simple mounting of the equipped frames on the control cabinet wall
- No new mounting cut-outs necessary
- Mounting set consisting of two mounting brackets, washers and screws (M4, Torx)



#### 4. terminal block modules for the exterior side #11510

- Multi-level, slim design for integration into the housing
- Integrated test tap at each terminal point
- tool-free PUSH IN connection

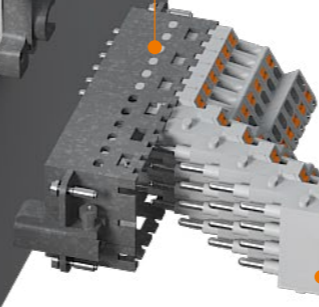

# Convenient assembly and installation

## RockStar® and ModuPlug

With up to 48 poles in one connector, the new RockStar® ModuPlug terminal block modules enable efficient wiring from the field to the devices in the control cabinet. Clever features such as the cross-connection channels and integrated longitudinal connections, flexible markers and the integrated test tap at each terminal point ensure particularly convenient installation and maintenance.



### Optimal readability

The tiltable marker enables readability from any position.

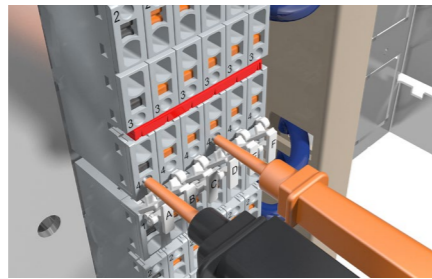

### Simple voltage control

The voltage test can be conveniently performed at any terminal point.

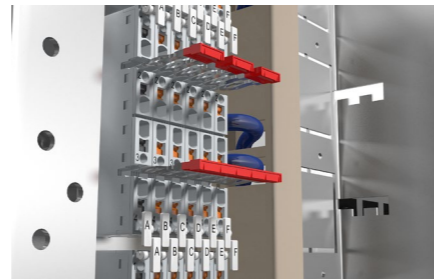

### Distribution of potentials

Integrated connection channels for 2- to 12- pole cross connectors and variants with longitudinal connections available.

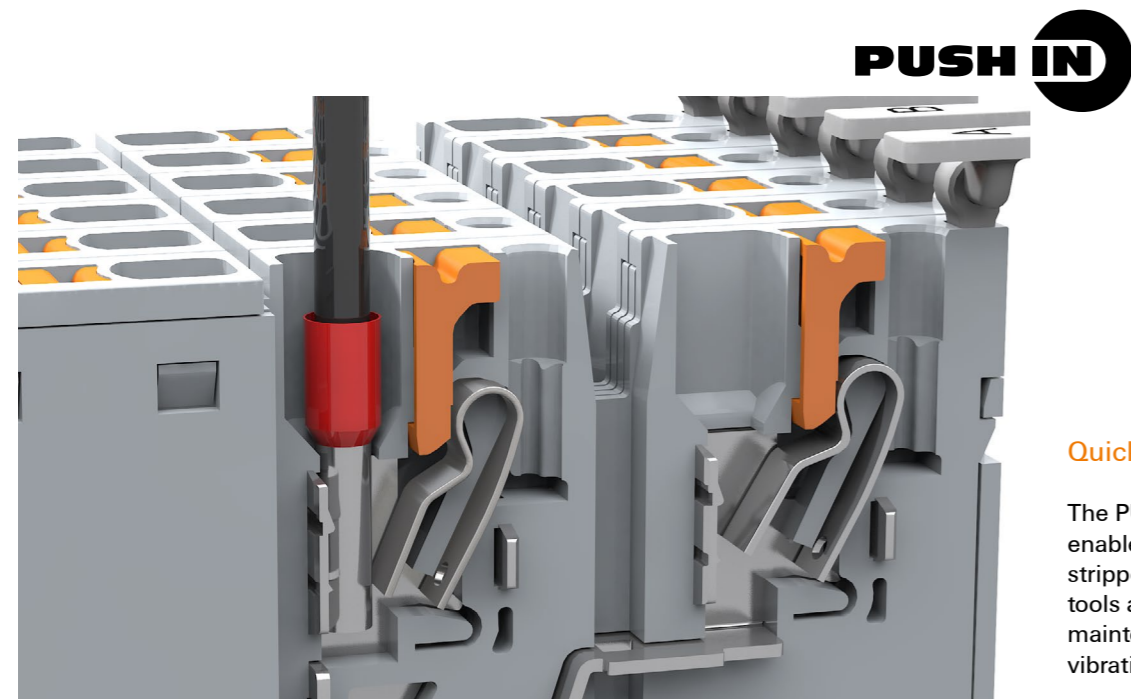

### Quick connection

The PUSH IN connection enables direct wiring of stripped conductors without tools and ensures a safe, maintenance-free and vibration-proof connection.

### Easy installation in any application

This is what the new RockStar® ModuPlug terminal block modules with PUSH IN connection technology offer. They open up new wiring possibilities, especially for signal distribution. Combined with mounting brackets and IP 67 housings, devices can be connected to the field through the heavy-duty connectors without the use of terminal blocks in the cabinet.

### Installation from outside

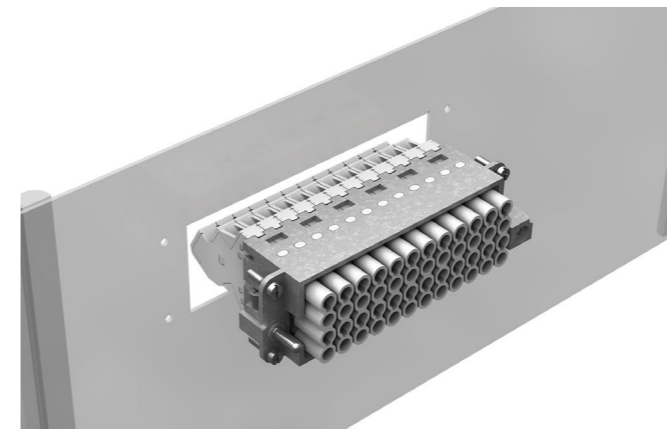

- The two brackets are either screwed to the control cabinet wall or directly to the frame before installation
- The frame is then simply mounted to the control cabinet wall from the outside

### Installation from inside

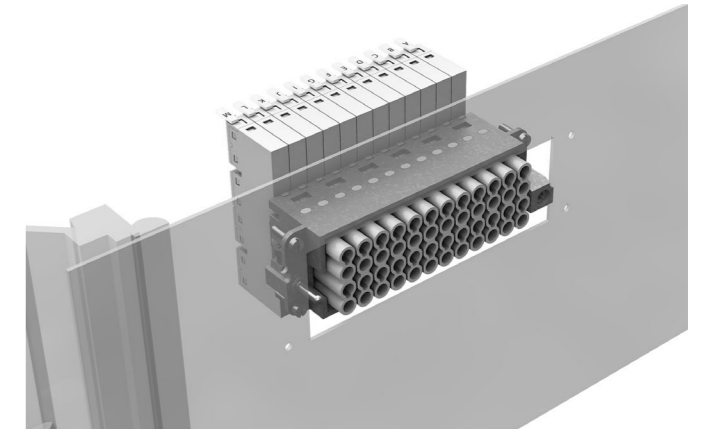

- When using wide modules or where space is limited, the assembled frame can be mounted from the inside
- For this purpose, the adapters can be attached one after the other on the outside or released until they can be pushed to the side



### One connector, many possibilities

More for less: The modular connector system RockStar® ModuPlug solves space problems by offering more functionality in a reduced installation space. Combine modules for data, signal and power transmission in one interface. Thanks to new module widths such as size 0.5 and innovative data inserts, you can transmit 50 percent more signals and up to 10 Gbit in one module.

[www.weidmueller.com/moduplug](http://www.weidmueller.com/moduplug)

# Order data - Modules

## ModuPlug Inserts

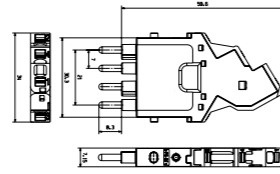
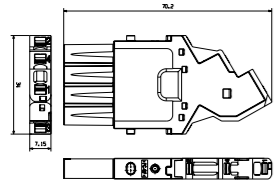

Connector module			
Type	Size	No. of poles	Order No.
HDC MHE 4 FP	0.5	4	<b>2635990000</b>

Connector module			
Type	Size	No. of poles	Order No.
HDC MHE 4 MP	0.5	4	<b>2635980000</b>

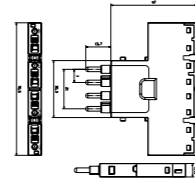
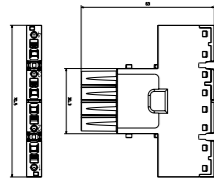

Terminal module			
Type	Size	No. of poles	Order No.
HDC MHE 4X FP	0.5	4	<b>2636060000</b>

Terminal module			
Type	Size	No. of poles	Order No.
HDC MHE 4X MP	0.5	4	<b>2636070000</b>

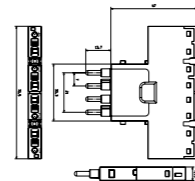
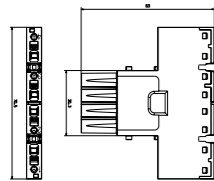

Terminal module			
Type	Size	No. of poles	Order No.
HDC MHE 4X2 FP	0.5	4	<b>2636080000</b>

Terminal module			
Type	Size	No. of poles	Order No.
HDC MHE 4X2 MP	0.5	4	<b>2636090000</b>

# Frame and housing order data

## Size 3

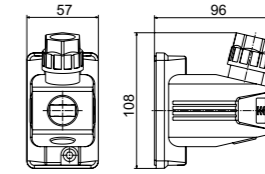
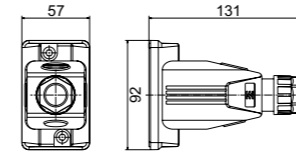

Cable outlet on top			
Version	b(mm)	Type	Order No.
		HDC 06B TOS 1M25 WMP	<b>2716700000</b>

Cable outlet on the side			
Version	b(mm)	Type	Order No.
		HDC 06B TSS 1M25 WMP	<b>2716750000</b>

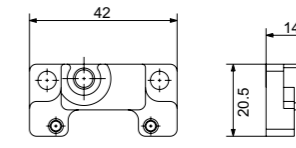
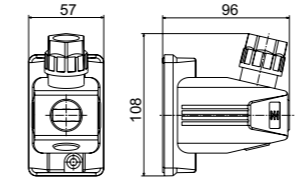

Cover			
Version	b(mm)	Type	Order No.
		HDC 06B AF WM COVER	<b>2716810000</b>

Mounting brackets			
Version	b(mm)	Type	Order No.
		HDC AF WM	<b>2716790000</b>

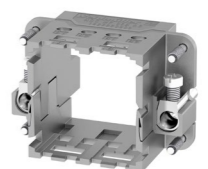
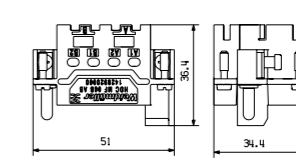
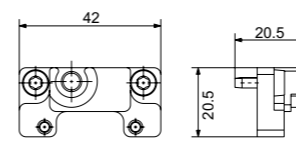

Mounting brackets set			
Version	b(mm)	Type	Order No.
		HDC AF SET WM	<b>2716800000</b>

Frame			
Version	b(mm)	Type	Order No.
		HDC MF 6B AB	<b>1428920000</b>

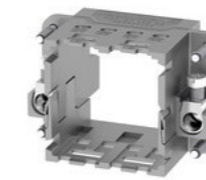
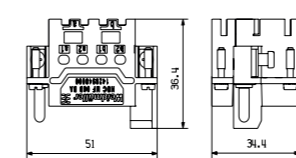

Frame			
Version	b(mm)	Type	Order No.
		HDC MF 6B BA	<b>1428940000</b>

# Frame and housing order data

## Size 4

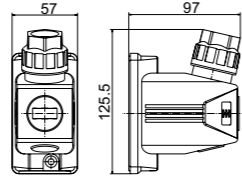
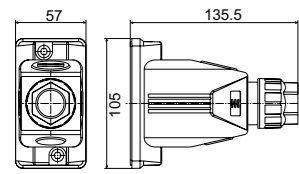

Cable outlet on top			
Version	b(mm)	Type	Ordner No.
		HDC 10B TOS 1M32 WMP	<b>2716720000</b>

Cable outlet on the side			
Version	b(mm)	Type	Ordner No.
		HDC 10B TSS 1M32 WMP	<b>2716760000</b>

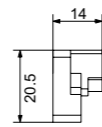
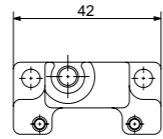
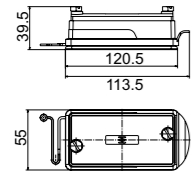

Cover			
Version	b(mm)	Type	Ordner No.
		HDC 10B AF WM COVER	<b>2716820000</b>

Mounting brackets			
Version	b(mm)	Type	Ordner No.
		HDC AF WM	<b>2716790000</b>

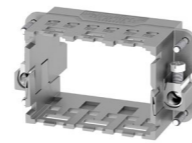
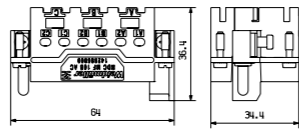
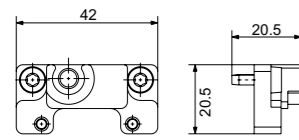

Mounting brackets set			
Version	b(mm)	Type	Ordner No.
		HDC AF SET WM	<b>2716800000</b>

Frame			
Version	b(mm)	Type	Ordner No.
		HDC MF 10B AC	<b>1428960000</b>

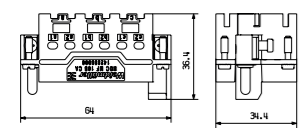

Frame			
Version	b(mm)	Type	Ordner No.
		HDC MF 10B CA	<b>1428980000</b>

# Frame and housing order data

## Size 6

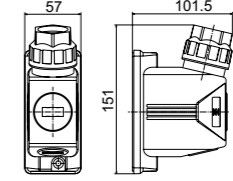
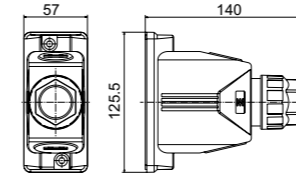

Cable outlet on top			
Version	b(mm)	Type	Ordner No.
		HDC 16B TOS 1M40 WMP	<b>2716730000</b>

Cable outlet on the side			
Version	b(mm)	Type	Ordner No.
		HDC 16B TSS 1M40 WMP	<b>2716770000</b>

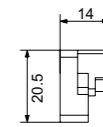
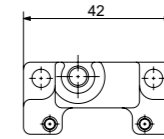
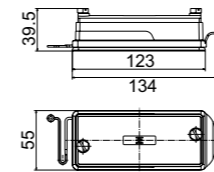

Cover			
Version	b(mm)	Type	Ordner No.
		HDC 16B AF WM COVER	<b>2716830000</b>

Mounting brackets			
Version	b(mm)	Type	Ordner No.
		HDC AF WM	<b>2716790000</b>

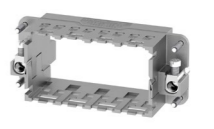
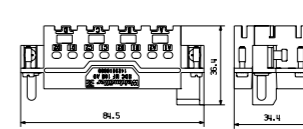
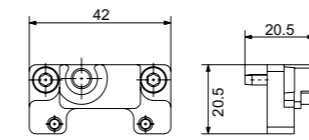

Mounting brackets set			
Version	b(mm)	Type	Ordner No.
		HDC AF SET WM	<b>2716800000</b>

Frame			
Version	b(mm)	Type	Ordner No.
		HDC MF 16B AD	<b>1429010000</b>

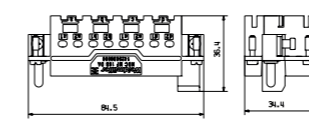

Frame			
Version	b(mm)	Type	Ordner No.
		HDC MF 16B DA	<b>1429030000</b>

# Frame and housing order data

## Size 8

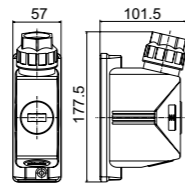
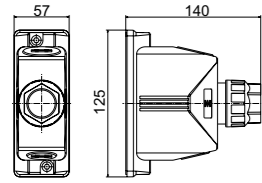

Cable outlet on top			
Version	b(mm)	Type	Order No.
		HDC 24B TOS 1M40 WMP	<b>2716740000</b>

Cable outlet on the side			
Version	b(mm)	Type	Order No.
		HDC 24B TSS 1M40 WMP	<b>2716780000</b>

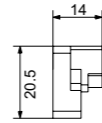
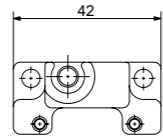
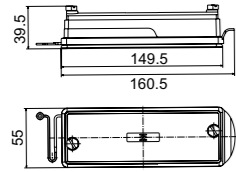

Cover			
Version	b(mm)	Type	Order No.
		HDC 24B AF WM COVER	<b>2716840000</b>

Mounting brackets			
Version	b(mm)	Type	Order No.
		HDC AF WM	<b>2716790000</b>

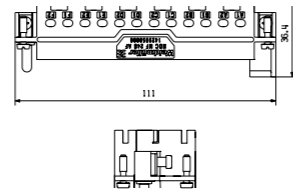
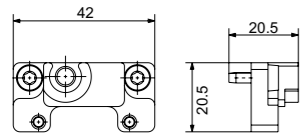

Mounting brackets set			
Version	b(mm)	Type	Order No.
		HDC AF SET WM	<b>2716800000</b>

Frame			
Version	b(mm)	Type	Order No.
		HDC MF 24B AF	<b>1429050000</b>

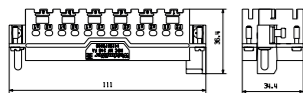

Frame			
Version	b(mm)	Type	Order No.
		HDC MF 24B FA	<b>1429070000</b>

## Accessories



Markers			
Version	b(mm)	Type	Order No.
		HDC MMARK 4	<b>2710590000</b>

Cross connector			
Version	b(mm)	Type	Order No.
		HDC MXCC2 4X	<b>2709710000</b>

640 blank markers

2 pole cross connector (up to 12 poles available)

Simple and fast configuration

Save time and reduce errors by configuring your connector with matching inserts, contacts and housings easily and conveniently online  
[www.weidmueller.com/moduplug](http://www.weidmueller.com/moduplug)